

A TOOL-KIT FOR INTERACTIVE EXHIBITIONS FOR THE PARTIALLY SIGHTED AND BLIND

**BY
NICOLA L. KRAUSE**

This dissertation is submitted in partial fulfilment of the requirements for the degree of
Master of Science in Virtual Environments.

**BARTLETT SCHOOL OF GRADUATE STUDIES
UNIVERSITY COLLEGE LONDON
SEPTEMBER 2004**

ABSTRACT

Exhibitions in museums, art galleries and other cultural centres are generally designed for normally sighted visitors and are therefore not easily accessible for partially sighted or blind persons. To make exhibitions more suitable for the visually impaired, interactive installations should be offered which take the special human factors requirements of the visually impaired into consideration and enable them to examine exhibits without assistance. To keep installation costs low, it is desirable to have a single system that can be used for different exhibitions.

The project described here aimed to address and solve these problems, firstly through the design of various interactivity scenarios, which take into account the capabilities and disabilities of visually impaired people, and secondly through the development of a flexible and reusable installation kit for providing the interactivities. The functionality of the tool-kit prototype was proven by successfully testing an exemplary installation for a photographer who was looking for new ways of presenting his documentary photographs about blindness to partially sighted and sighted audiences. The installation kit has the advantage of being made up of commercially available components and therefore low-cost; it can be used for any kind of interactive installation and is beneficial for visually impaired as well as normally sighted people.

Keywords

Interactive installation, visually impaired, images, sensors, MIDI

Word Count

9 744

TABLE OF CONTENTS

ABSTRACT	I
Keywords	I
Word Count	I
TABLE OF CONTENTS	II
1 INTRODUCTION	01
2 PRESENT INNOVATIVE EXHIBITIONS FOR PARTIALLY SIGHTED AND BLIND PEOPLE	03
2.1 Tate Modern's "i-Map" Exhibition	03
2.2 Earth from the Air Exhibition	04
2.3 The COMPASS System of the British Museum	04
2.4 Discussion of the exhibitions	05
3 INTRODUCING INTERACTIVITY INTO EXHIBITIONS	07
3.1 Interactive Installations to Enhance the Attractiveness of Exhibitions	07
3.2 Sensors for Interactive Installations	07
4 THE TOOL-KIT FOR INTERACTIVE INSTALLATIONS	10
4.1 The Tool-Kit Components	10
4.2 Sensors and their Interface	10
4.3 The Computer and Control Programme	12
4.4 Output Media and Devices	13
5 INSTALLATION SCENARIOS	15
5.1 Scenario Showing what is Possible	15
5.2 Hardware and Software for Test Scenarios	18
5.3 Test Scenario with Simple Interactions	19
5.4 Test Scenario with Sophisticated Filters	20
6 TEST OF TOOL-KIT PROTOTYPE	23
6.1 Test Scenario	23
6.2 Equipment for Prototype	23
6.3 Real-Life Test of Prototype	24
6.4 Evaluation of Questionnaire	25
7 CONCLUSIONS	27
8 FURTHER WORK, TOOL-KIT EXTENSIONS	28
9 ACKNOWLEDGEMENTS	30
Contact Details	30
10 APPENDIX	31
Appendix A - MIDI	31
Appendix B - MIDI Compatible A/D Converters	32
Appendix C - Circuitry for Pressure Mats	33
Appendix D Tool-Kit Hardware and Software Components	34

Appednix E - Questionnaire Evaluation	35
10 BIBLIOGRAPHY	38
10.1 References Used in Thesis	38
10.2 Project Background Study	38
Innovative Exhibition Concepts and Online Resources	
Institutions and Organisations Supporting Projects for the Blind and Visually Impaired	
Companies, Technology, Services and Products for the Blind and Visually Impaired	
Interactivity - Sensor Technology and Software Programmes	
Surveys, Reports and Publications	

1 INTRODUCTION

According to current research statistics compiled by the Royal National Institute of the Blind (RNIB) in 2003 there are more than 2 million people in the UK with sight problems and the number of blind and partially sighted people is expected to rise sharply in the future as a result of the UK's ageing population [RNIB, 2003a]. Seen in this light it is becoming ever more important to provide for blind and partially sighted people access to museums, galleries and heritage sites so that they can enjoy the same rights, opportunities and quality of life as sighted visitors.

Another outcome of the above mentioned survey [RNIB, 2003a] was that although the Disability Discrimination Act has helped to bring about many significant changes regarding access to arts and heritage services for disabled people and a number of organisations and venues have already displayed good practice in providing some sort of access for blind and partially sighted people, many still have a considerable way to go before the rights outlined in Article 27 of the UN Universal Declaration of Human Rights apply equally to blind, partially sighted and sighted users alike, namely that

"Everyone has the right freely to participate in the cultural life of the community, to enjoy the arts and to share in scientific advancement and its benefits."

This means that more of the already available improvements as well as new and innovative improvements for blind and partially sighted people are needed.

Examples of the already available ways of improving independent access to exhibitions are services such as catalogues on tape, Braille text, tactile diagrams, embossed art works as well as audio guided tours, so-called "touch tours" and tactile exhibitions. The last two are guided special tours that offer opportunities of supervised handling of selected exhibits. These tours are a great improvement but still deter visually impaired visitors, at least partially, from wandering freely through the exhibition and having unexpected and surprising encounters with individual exhibits.

Using computers and new technology, new and innovative improvements have been achieved in producing embossed art works and raised drawings. Three of the more recent and advanced projects are described in chapter 2. In these projects computers generate images that are either displayed on computer screens at the site or at home via the internet. This is certainly a good start in making more museum and art exhibits accessible to people with visual disabilities but it still does not enable them to experience exhibitions in a way more similar to normally sighted people, characterised by freedom of movement and selection. But how can this freedom be achieved?

The answer given in this thesis is to provide interactive installations that allow the visually impaired to move freely in the installation space and to select freely the exhibit and view it in a way that is controlled by the individual. Basic viewing parameters are for example magnification, position, image contrast and resolution. Another important feature of the suggested installations is that the visual information is not displayed on a computer screen but on one or more large projection screens or walls. Larger images are more suitable for partially sighted visitors and they also enable several people to observe the same exhibit simultaneously thus allowing group experiences.

In addition to the projected images, supporting acoustic or tactile information can be provided for helping the partially sighted. The interactions and additional information are primarily aimed at the visitors with visual impairments but can without any problem also be used by normally sighted people. In this way the normally sighted visitors can experience the difficulties of the visually impaired and gain greater understanding for them.

These interactive installations will most likely be more readily implemented if the costs involved are moderate. In order to keep costs low, the aim of this project is to provide an installation kit that is comprised of commercially available components which require no special development and which can be used for a variety of interactive exhibitions. The installation kit has the further advantage that it can be installed and used by anyone with moderate technical understanding and skills, thanks to component pre-assembly.

2 PRESENT INNOVATIVE EXHIBITIONS FOR PARTIALLY SIGHTED AND BLIND PEOPLE

The Royal National Institute of the Blind (RNIB) sponsored the "Talking Images" research project [RNIB, 2003a; RNIB, 2003b] to assess the extent to which selected museums, galleries and heritage sites were accessible to blind and partially sighted people. One of the project's key findings relevant for this thesis is:

People get "life enhancement" from experiencing exhibitions independently, without having to rely on intermediaries, and from non-linear tours.

"Non-linear tours" are also a form of independence, namely freedom of movement and selection. People can physically roam in the exhibition without having to follow either a fixed sequence of exhibits or a fixed order in which an exhibit is presented.

In order to find out to what extent independence and freedom of movement and selection can be found in present exhibitions designed for partially sighted and blind visitors, three recent innovative exhibitions are described in the following paragraphs and discussed under these aspects.

2.1 Tate Modern's "i-Map" Exhibition

"i-Map" [TATE, 2002] was a new online art resource on the internet "to help visually impaired people explore key concepts in modern art". It complemented the "Matisse Picasso" exhibition at Tate Modern in 2002 by focusing on three pairs of works by the artists that "explore their innovations, influences and personal motivations" but it will be permanently available after the "Matisse Picasso" exhibition finishes.

The features for partially sighted users are:

- explanatory text that can be enlarged to suit user needs,
- enhanced pictures that make the recognition of important picture elements easier,
- animations that simplify, enlarge and pull out key picture elements (Fig. 2.1) so that they can be studied in isolation before being put back into the context of the whole picture.

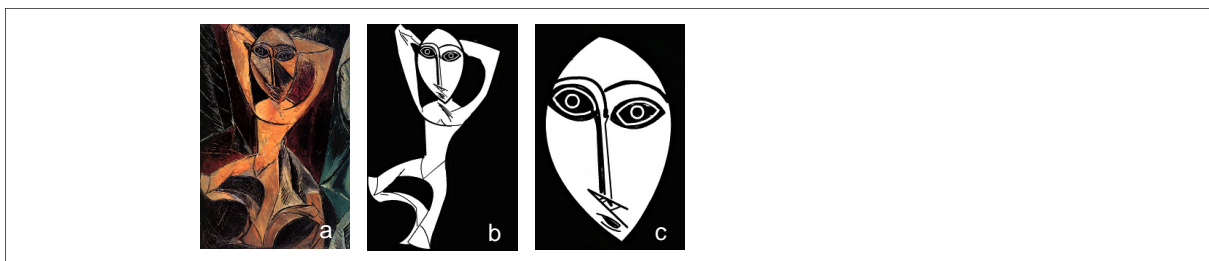

Fig. 2.1: Animations in i-Map.
a) original image, b) simplified version, c) extracted key element, enlarged

The special features for blind users are:

- audio descriptions instead of the explanatory text animations,
- raised images which provide tactile confirmation of the user's mental image of the picture.

- However, printed from the web site, copied onto special 'swell paper' and put through a machine that raises the lines, tactile images are still expensive to produce.

2.2 Earth from the Air Exhibition

This exhibition at the Natural History Museum in London 2003/2004 displayed aerial photographs which were based on the photographer Yann Arthus-Bertrand's famous project "Earth from the Air" [BERTRAND, 2003] and which offered stunning perspectives of the natural and man-made patterns and colours in landscapes to fully-sighted people.

Thirty photos were selected and especially prepared for the blind and visually impaired by

- providing Braille narrative panels and large print information for each photograph,
- transforming the aerial photographs into tactile images, Figure 2.2.

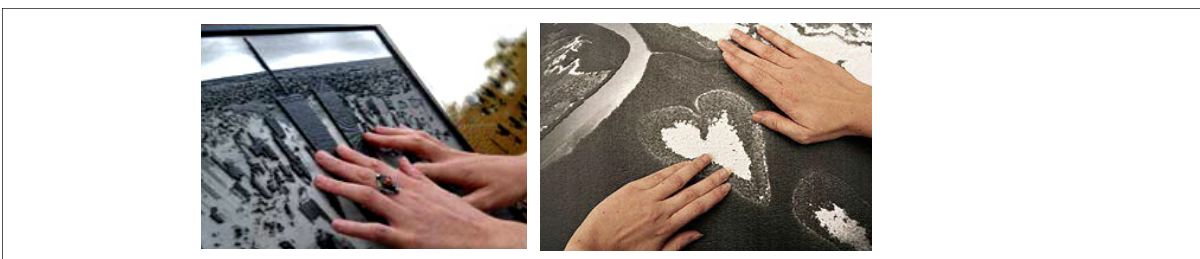

Fig. 2.2: *Tactile images of areal photographs.*

The tactile images contained relief maps and different textures which allowed the production of a great amount of detail. But unfortunately, tactile images with too much detail become so complex that partially sighted people often have difficulty grasping the whole image. An example of such an image is the one of "Manhattan and the World Trade Towers". The picture of two camels in the desert, however, is quite easy to recognise.

2.3 The COMPASS System of the British Museum

The British Museum which endeavours to "make the collections widely available to all who seek to enjoy and learn from them" [BRITISH MUSEUM, 2001a] and "illuminate the history of culture for the benefit of present and future generations" [BRITISH MUSEUM, 2001b], introduced COMPASS [COMPASS, 2001] in 2001, an on-line database comprising around 5,000 objects chosen from the British Museum's collections.

The COMPASS features are

- Each object is illustrated with high quality images (Fig. 2.3) that can be enlarged and studied in detail.
- COMPASS is available on computer terminals and on specially designed touch-screens at the museum and also on the internet.



Fig. 2.3: Example image of COMPASS system. a) original image, b) enlarged version

COMPASS was one of six leading UK websites which received the Visionary Design Awards in 2002 for their outstanding efforts in ensuring that their websites are accessible to visually impaired people. The Awards are part of an ongoing campaign by the National Library for the Blind (NLB) to encourage website publishers and designers to consider access technology such as magnification, text to speech and refreshable Braille when they are designing their sites. At the award ceremony NLB's Chief Executive said: "NLB estimates that less than a third of websites are accessible to visually impaired people, making the winners of these Awards truly revolutionary in what they have achieved".

The enthusiasm of NLB's Chief Executive about COMPASS, which uses large icons and text but not text to speech and refreshable Braille, can only be understood in the context of the lack of assistance for partially sighted visitors in other online exhibitions.

2.4 Discussion of the Exhibitions

The described exhibitions represent the state of the art in exhibition design for partially sighted people. The following discussion aims to answer the question to what extent freedom of movement and selection can be found in these exhibitions.

In all three examples the freedom of movement is very limited since all images are displayed on computer screens or displays of similar size and users are more or less confined to stand or sit in front of the screen. Furthermore the small size of the displays does not allow several people (whether normally sighted or not) to view the displayed images simultaneously in a comfortable manner and is therefore an obstacle to having group experiences with discussions, exchange of ideas and impressions, observing reactions of others, etc.

The exhibitions support freedom of selection to different degrees. These supporting features are listed below.

COMPASS

The user can select from a large database of more than 5000 images of exhibits. The selection and viewing of a particular exhibit is supported by large icons and text as well as image magnification (zooming) for study of detail. The zoom function is of limited help when partially sighted persons have difficulty grasping the original image with all its detail. In this case only a larger image can help.

i-Map

The user can only select from a very small database of 6 paintings of two artists. This small database is sufficient for the purpose of i-Map, namely "to help visually impaired people explore key concepts in modern art" [TATE, 2002]. These concepts can be demonstrated with the manually produced paintings' key elements and animations. But these elaborate preparations cannot be done for large numbers of exhibits (like in the COMPASS database) because of the high production costs. An alternative for larger databases could be to provide image processing and filtering tools which the partially sighted user can apply so that the processing result is of more benefit to him.

Earth from the Air

The user can only select from 30 aerial photographs which are especially prepared to be "printed" (embossed) as tactile images for visually impaired and blind people. As already mentioned with i-Map these elaborate preparations are very costly and can therefore not be done for large databases. Possibly here too, image processing and filtering tools can be provided which the partially sighted user can apply to obtain optimally perceivable images.

Conclusion of discussion

The discussion shows that, although access was improved for partially sighted visitors in all of the exhibitions mentioned, access can be further improved by introducing interactive installations which give the visitors more control over what they want to see and how they want to see it - thereby having more independence in experiencing the exhibition.

3 INTRODUCING INTERACTIVITY INTO EXHIBITIONS

3.1 Interactive Installations to Enhance the Attractiveness of Exhibitions

The computer based exhibitions described in the previous chapter have interactive elements, namely computer keyboards or specially designed touch screens, but no interactive installations. Interactive installations, developed in the project described in this thesis, have the following characteristics:

- The installation is in rooms similar to normal exhibition rooms.
- Several people can be present simultaneously in the exhibition room.
- Interaction with the installation, or more precisely with the controlling computer, requires the visitor(s) to move about and trigger sensors (no keyboards, touch screens or the like).
- The sensors are distributed in the room, on the floor, walls or ceiling - either visible or not, as required.
- The results of the interactions can be:
 - images projected on big screens or walls, or displayed on video screens, or large screen displays,
 - sounds presented in mono, stereo or spatial form,
 - lights, white or coloured, switched on or off, flashing or moving,
- The interaction results can either be made known to the visitors beforehand, or left for them to discover for themselves.
- The interaction result can be constant over time or change to provide different interaction scenarios.

The aim of the interactive installations is to support partially sighted people in their use and enjoyment of exhibitions so that their experiences are as similar as possible to those of normally sighted people. Some means for achieving this are the use of large images in the exhibition rooms and the interaction facilities (sensors) with which the visitors can adjust the images according to their individual needs and at their own pace. Different visual impairments require different adjustments regarding size, brightness, contrast and position.

Through these interactions the visitors become active elements in the exhibitions; they take part and become more involved. Experiencing exhibitions together with others or simply watching others interact with the installation should encourage interaction between visitors: discussions about impressions, exchange of perceptions etc.

3.2 Sensors for Interactive Installations

Sensors can measure physical quantities like pressure, light, sound, motion, heat, electromagnetism and transform them into measurable corresponding electrical signals. The analogue sensor signals have to be converted into digital form in order to be processed by a (digital) computer and trigger a reaction.

A computer microphone, for example, is a sensor which converts the sound pressure waves of speech or music into electrical signals that have the same peaks and valleys as the sound waves. The computer's sound

card converts the analogue electrical signal into digits which can be further processed by a programme. This processing may have the result that a stored image is displayed on the screen if a certain sound level or pitch is exceeded. In this scenario the person, who has caused the sound, has triggered the display of an image.

Triggers such as the following can be used in interactive installations for exhibitions: actions and movements of the visitors are detected by sensors and trigger certain responses like the display of one or more images, the filtering and magnification of images, the playing of sounds and music, or the flashing of lights. Examples of visitor actions are clapping hands for triggering sound sensors, switching torches on and off for triggering light sensors and stepping on certain areas on the exhibition floor for triggering pressure sensors.

Interactive installations for partially blind people have to take into consideration that only those sensors can be used which do not require visually demanding actions or movements from the users like pointing at something small or moving with high accuracy in a dark surrounding. But there are various suitable sensors commercially available which are now briefly described.

Pressure sensors come in two forms. They either measure the pressure (resulting in analogue measurements) executed to a particular area or simply detect when the pressure applied exceeds a pre-set threshold (functioning like a switch). The latter sensor is integrated in so-called pressure mats which can be used on the floor or on the wall. To trigger sensors on the floor the user simply has to step, jump or walk on them. Sensors on the wall can be triggered by pushing with hands.

Pressure mats on the floor can be used for determining a visitor's position in an exhibition room. The position of the visitor corresponds to the position of the triggered mat. With several mats motion can be detected by registering the triggers from different mats.

Light sensors measure the amount of light that falls onto them, either resulting in analogue measurements or "on/off" signals when the light level lies above or below a pre-set threshold. Light sensors with "on/off" signals are widely used in night lights, alarms, toys, etc. There are sensors that are sensitive to normal visible light or to invisible infrared or ultra violet light. Infrared light sensors also detect heat and can therefore be used to detect the presence of persons (who emit heat).

Special light sensors can determine the position of small light sources like torch lights. If visitors carried small lights, their position in an exhibition room could be determined with a "position camera" on the ceiling.

Light barriers for detecting the presence or absence of objects and/or counting them consist of two parts: a light source (the light emitter) and a light sensor (the light receiver). The receiver detects whenever the light beam from the emitter is interrupted, for example by a person passing through the light beam.

Light curtains are a vertical arrangement of light barriers and can detect persons moving into a part of the exhibition room more reliably than a single light barrier.

Sound sensors are used in such diverse devices as microphones and proximity sensors. As already mentioned above, microphones receive sounds and convert them into analogue electrical signals.

Proximity sensors can measure distance within a relatively short range. They use ultra sound and consist of an emitter and receiver which are situated next to each other into the same casing. The emitted sound can only be received by the receiver if it is reflected by an object in front of the proximity sensor. The distance of the object is determined from the time it takes for the sound to travel from the emitter to the reflecting object and back to the receiver. Proximity sensors placed near an exhibit can detect when a person is approaching the exhibit or is close to it.

Motion sensors are based on other sensors since motion cannot be determined directly like pressure, light and sound. Motion sensors rely on determining changes, for example change of position or intensity. In the motion sensors of the familiar home safety lights, motion is detected when a person moves in or out of the infrared light sensor's field of view. A single light sensor cannot determine the direction of motion; to do that, at least two sensors are needed.

4 THE TOOL-KIT FOR INTERACTIVE INSTALLATIONS

4.1 The Tool-Kit Components

The tool-kit for interactive installations is the computer system shown in Figure 4.1. It consists of the following basic components:

- Sensors pick up the users' interactions with the installation.
The sensor signals are transmitted to the computer via any necessary interfaces.
- The control computer supervises the reception of the sensor signals, determines what kind of output has to be directed to which of the output devices.
- The output devices receive the outputs via any necessary interfaces

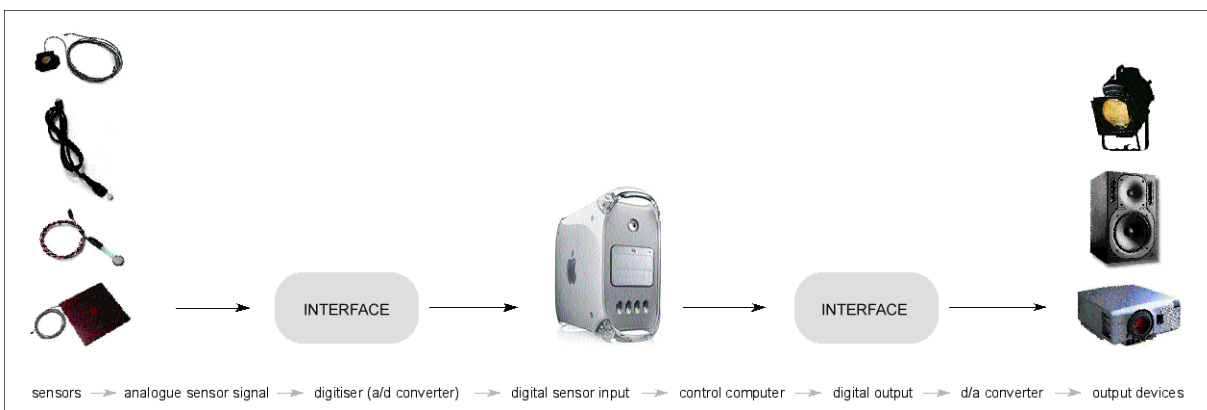

Fig. 4.1: *Tool-kit for interactive installations*

The basic system has been turned into a versatile tool-kit for interactive installations with the following design goals in mind:

- Each of the three system components has to be so flexible and exchangeable that the system can be easily adapted to a broad range of interaction scenarios.
- The control programme can be adapted to different interaction scenarios by simply setting parameters in the programme.
- Any average computer user can make the system adaptations without having to know many technical details about the components and how they are connected.
- The cost for the tool-kit has to be low in order to make it attractive for exhibitions with moderate budgets.

The design goals have been achieved by using commercially available and, whenever possible, standardised hardware and software components which are described in the following chapters 4.2 – 4.4.

4.2 Sensors and their Interface

Sensors are the key hardware elements for interactive installations because they are the immediate link between the visitors and the interactive system. The user interaction with a sensor produces a sensor signal,

the so-called trigger or trigger signal, which is converted in the interface so that it can be input to the control computer.

In addition to the system requirements listed in the previous chapter, the following requirements for the interface have to be fulfilled:

- only one interface for all the sensors described in chapter 3.2,
- an analogue-to-digital (A/D) converter to transform the analogue sensor signals into digital form for the computer,
- the link between interface and computer has to be via one of the computer's standard input ports, such as serial, parallel, USB, fire-wire or Ethernet,
- the format of the digital sensor signals has to be compatible with the data format of the computer's programme which receives the sensor data,
- the programme receiving the data has to be software compatible with the control and processing programme.

Writing special C++ programmes for the interface and the control computer is not the answer because such application specific programmes are usually in use only as long as the programmer is at hand for debugging, adjustments and extensions, regardless of the programme's user interface. But commercially available programmes have the potential of being in use longer and being developed further. The question is how to find suitable programmes that fulfil the requirements.

Finding the desired programmes and standards began during the MSc Virtual Environments course at a workshop on "Interactivity" which was part of the module "Multimedia and its Application". One of the programmes introduced was ISADORA, a graphic programming environment [ISADORA, 2003; TROIKA, 2004; CONIGLIO, 2003] which can be used for developing control and processing programmes and which, more importantly, accepts input in the standardised MIDI format. Details about MIDI can be found in Appendix A.

MIDI (Musical Instrument Digital Interface) is a standard typically used for communication between electronic musical instruments. The MIDI standard defines a communications protocol which specifies the hardware, i.e. the type of connectors, cables and voltages (or currents) involved, and the software, i.e. the data exchange format.

Since part of the communication is control information the idea arose that the same control information can also be applied for controlling interactive installations. But using the MIDI standard is only possible if there are A/D converters (digitisers) which can output the digitised sensor signals in MIDI format. Fortunately four firms could be found that supply MIDI compatible A/D converters. A list of the firms, their products and web addresses is given in Appendix B.

The interface chosen for the tool-kit is from the company Infusion Systems because it has a medium priced digitiser with the biggest number of inputs and the largest selection of sensors that could be directly used with the digitiser. The interface comprises two components: the digitiser "I-CubeX" and the high speed USB

connector "MIDISPORT" to the computer [INFUSION, 2004]. A block diagram of the interface with its components as well as a photo of the components are shown in Figure 4.2.

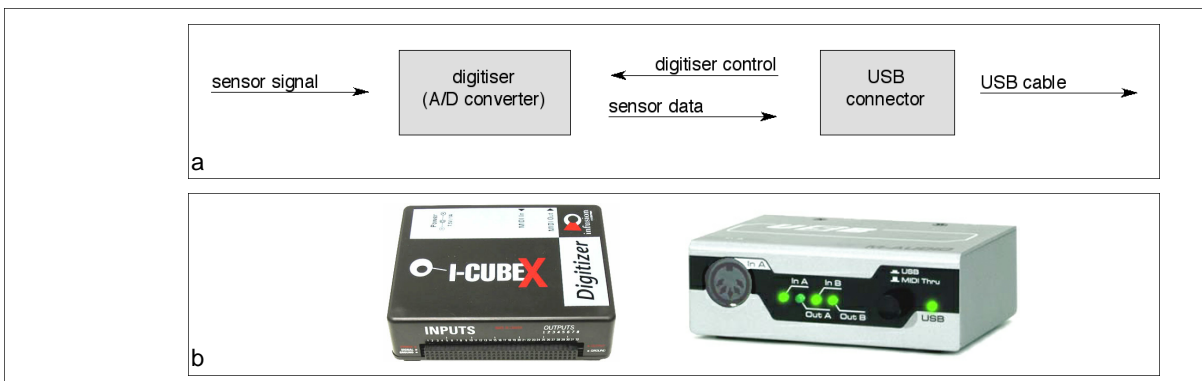

Fig. 4.2: Block diagram and photo of the tool-kit MIDI interface with its components.

a: Block diagram of MIDI interface with digitiser and USB connector

b: Photo of the MIDI interface components: digitiser and USB connector

The digitiser hardware is controlled by the digitiser software which in turn is controlled by a programme running on the control computer. The digitiser software converts the (digital) sensor data into MIDI format and sends it to the USB connector from where the MIDI data is transferred to the computer via a USB cable. The digitiser and the USB connector are linked by two MIDI cables: one for the sensor data, the other for control information for the digitiser. More detailed information about the MIDI interface is provided in Appendix A.

Infusion Systems supply most of the sensors described in chapter 3.2. Their sensors are especially adapted to their digitiser and can therefore be exchanged in a 'plug-and-play' manner. This allows the tool-kit user to choose from a range of sensors without having to worry about incompatibilities or interface problems.

4.3 The Computer and Control Programme

The control computer receives MIDI data from the MIDI interface via its on-board Universal Serial Bus (USB) port, determines which sensor is the source of the input data, and decides what action has to be taken, such as outputting an image or a sound. The sensor input data is transformed into output actions by the control programme which is supported by two other programmes:

- The control programme is based on the ISADORA software [CONIGLIO, 2003] which accepts MIDI data and allows interactive, real-time manipulation of digital media such as prerecorded video, live video and sound.
- The digitiser configuration software allows the setting of the digitiser parameters; one group of parameters controls signal processing functions, the other group determines which sensors are connected to the different digitiser inputs.
- The MIDI interface driver enables the reception and transfer of MIDI data from and to MIDI devices or programmes.

The control programme is developed by linking together ISADORA modules, each of which performs a specific function on the digital media. The results are presented on video screens, loud-speakers and to MIDI interfaces. A special input module looks for information from the outside world, i.e. MIDI messages, keyboard and mouse actions, and messages sent over a Local Area Network. If a MIDI message from a sensor is detected, the control programme determines, according to stored information, what action has to be initiated. This action includes selection of stored images or sounds, their processing and output on a particular device, e.g. screen, projector or loudspeaker.

The networking ability of the input module is very important since it allows the use of two or more computers simultaneously and the increase of processing power which is desirable or even necessary when processing pre-recorded or live video. The networking capability is also required if more video outputs are wanted than can be handled by one computer's graphics card(s). In this case the video outputs can be distributed among several computers.

The fact that the control programme's input module accepts keyboard and mouse actions as well as MIDI messages from the sensors, is very useful for testing the control programme without sensors. Single sensors with "on/off" messages can be simulated by using keyboard input instead. But the simulation of several sensors being activated simultaneously is not possible since keyboard input does not allow the message "several keys are activated in parallel" to be generated.

4.4 Output Media and Devices

The control computer determines output actions depending on the messages received from the different sensors. The output actions are defined when the control programme is configured from ISADORA's processing modules. This configuration specifies what images, videos and sounds are involved, how they have to be processed, and to which output devices the processed media have to be directed.

Possible output devices that produce images and videos big enough for visually impaired people are video projectors, large video screens, and large screen displays. The output to these devices can be achieved directly with standard computer graphics cards. The simultaneous display of two or more different images requires special graphics cards or more than one computer.

There are graphics cards (Fig. 4.3) available which can handle two and even four different video outputs, but graphics cards for four images are intended for special purpose computers which have the necessary processing power to handle four images simultaneously. The graphics cards for two images can be used with powerful general purpose computers. If there is not enough processing power, then there can be a noticeable time lag between the sensor signal (triggered by interaction with the sensor) and the response action, i.e. the displayed image.

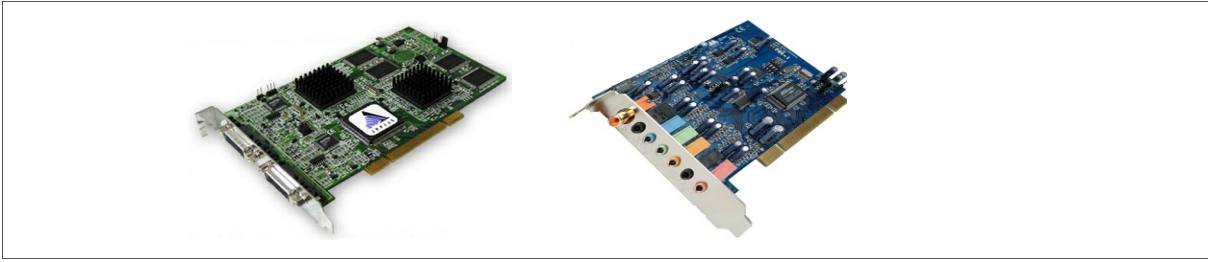

Fig. 4.3: *Dual Head graphics card (left) and multi-channel sound card (right).*

The ability of graphics cards to display two images is called ‘Dual Head’ functionality by some graphics cards producers [ATI, 2004]. For the display of four still images, two networked computers with a ‘Dual Head’ graphics card each are recommended. In this way the processing load is distributed between two computers, resulting in only a small time lag between the sensor trigger and system action.

In interactive installations for partially sighted people visual outputs should be supported by audio outputs such as speech, music and sound in order to compensate for any visual information or impressions that could not be perceived fully by the visually impaired. Suitable audio output devices are cordless headphones and loudspeakers; both devices gives the exhibition visitor full freedom of movement.

To output more than one audio signal at a time either multi-channel sound cards (Fig. 4.3) or several computers with sound cards are required. With multi-channel sound cards spatial audio can be generated which enables the visitor to differentiate sounds coming from various directions and experience spatial sound scenarios.

The output actions are not restricted to the display of images and videos and the emission of sounds. It is also possible to initiate actions that operate switches for lights, doors and other gadgets. For these actions extra output interfaces are necessary which are not standard computer interfaces like graphics and sound cards. To operate light switches, actuators are needed which transform the low energy computer output signal into higher energy signals that can perform the switching operation. This is necessary because light switches, for instance, cannot be operated directly by computers.

Low power analogue signals, needed to operate actuators, can be generated with the tool-kit by using the I-CubeX digitiser. Some of the digitiser’s input ports can alternatively be used as output ports for analogue signals; for these ports the digitiser can also function as a digital-to-analogue (D/A) converter.

5 INSTALLATION SCENARIOS

The state of the art in exhibition design, described in chapter 2, showed that museums, big galleries, and heritage sites have made efforts to improve access for blind and partially sighted people, but these improvements are mostly too expensive to be used by small exhibitions. What is needed are low-budget and reusable installations. And the tool-kit developed in this project is the answer to such needs.

In the following chapters 5.1 – 5.4, installation scenarios are described which can all be realised with the tool-kit. The installation scenario in chapter 5.1 is intended to show what is possible using the tool-kit and the more common sensors for user interaction. This scenario fulfilled the requirements of the photographer Tim Hetherington [HETHERINGTON 2004a] who supported this project. He was looking for new ways of presenting his documentary photographs to sighted and visually impaired audiences. The photos of his intended exhibition were taken in two schools for blind children (in England and Sierra Leone) over a couple of years [HETHERINGTON 2004b]. He wanted to present the photos in such a way that the missing or partially missing sight would be compensated as much as possible by involving the visitors' visual, aural and tactile senses.

The installation scenarios in chapters 5.2 and 5.3 were built as demonstration prototypes, the last one of which (described in chapter 5.3) was extensively tested by sighted persons. Originally it was intended to test the installation with partially sighted students who participated in Tim Hetherington's documentary but unfortunately this could not be arranged at the time.

5.1 Scenario Showing what is Possible

An installation scenario was designed which took into consideration the human factors of visually impaired people so that they can enjoy the exhibition, despite their restrictions by making use of their abilities. The exhibition consists of a sequence of distinct spaces or rooms with exhibits that can be mainly perceived either visually or aurally or tactilely. The interactive installations for such an exhibition can be implemented with the tool-kit.

A possible scenario for interactive installations in three rooms with different themes is depicted in Figure 5.1. The sensors used in these exemplary installations are pressure sensors, proximity sensors, motion sensors and light barriers. The visitors interact with the sensors and cause actions that are intended to provide visual, aural and tactile information. This improves access to the exhibition and individual exhibits not only for the blind and partially sighted but also for normally sighted visitors.

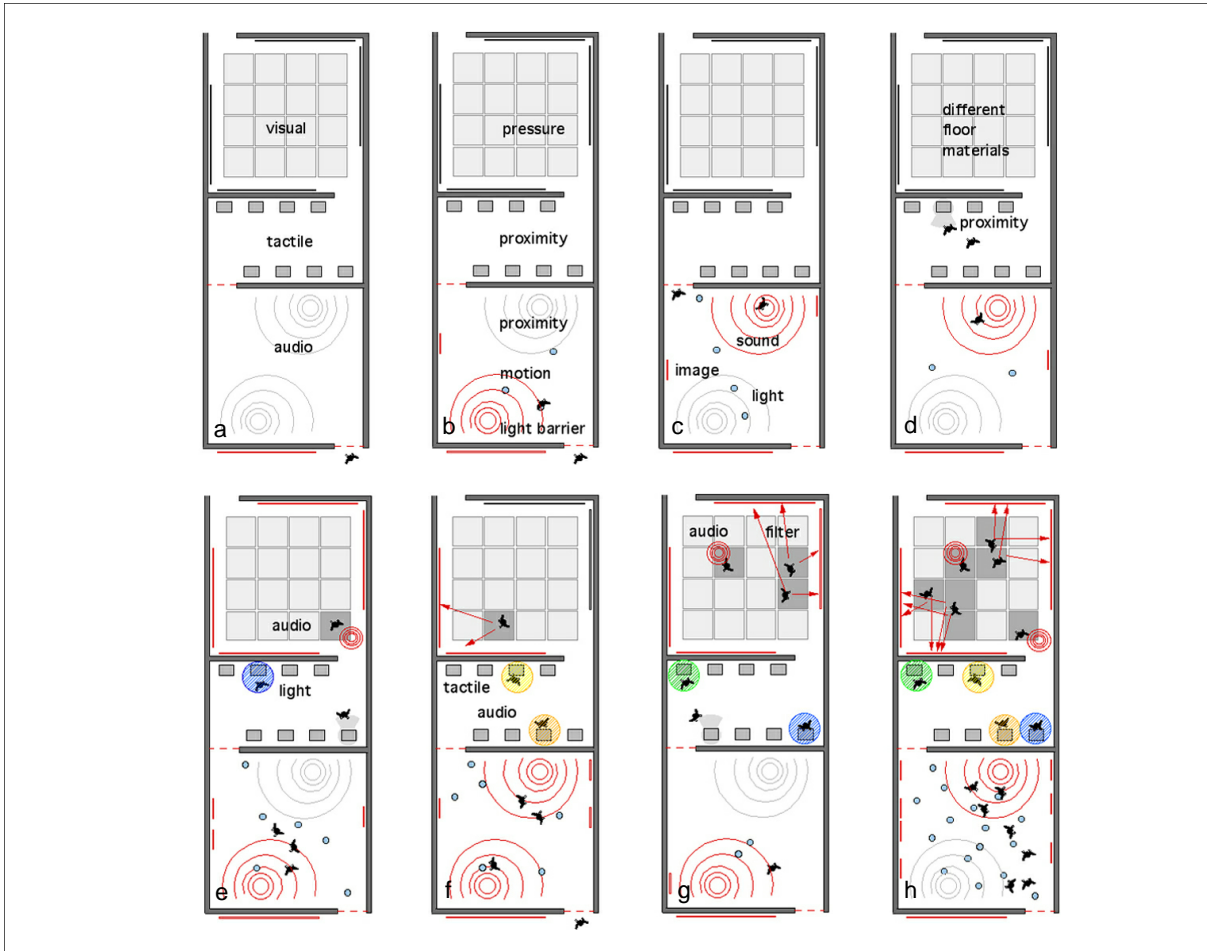

Fig. 5.1: Scenario of exhibition with interactive installations for partially sighted and blind visitors.
 a) senses mainly addressed in rooms, b) sensors used in rooms, c-h) different interactions of visitors

Next to the exhibition entrance is a large video screen on which the exhibition is announced with visually simple images or text that can easily be perceived by partially sighted people. The advantage of a video screen over conventional photographs is that the screen has more contrast and the content can be dynamic which usually attracts more attention. For blind visitors the exhibition is announced with speech and sound from one or several loudspeakers near the video screen and the exhibition entrance.

The Audio Room

Visitors entering the Audio Room (at the lower right corner in Figure 5.1a) pass a light barrier which triggers a welcome message from a loudspeaker and counts the number of people entering. The audio message is accompanied by short displays of images on one of the wall-mounted video monitors. For every new visitor entering the room, the welcome message is repeated and an additional monitor is started.

The distinguishing feature of the first room is spatial audio. Visitors trigger different audio narratives which are played on spatially distributed loudspeakers. The triggers are generated by proximity sensors which detect visitors close to a wall or in a certain area in front of the wall. With the help of these proximity sensors the narratives can be directed to those loudspeakers which are nearest to the visitors. In this way it is possible to minimise interference through speech and background sounds in one corner of the room by using audio in the opposite corner (Figure 5.1b).

The audio narratives in the two opposite corners of the room are complemented by the display of images; this is in contrast to the more frequent situation where images are complemented and supported by explanatory speech.

When visitors go on to the next room (Fig. 5.1c) they pass another light barrier which counts the persons leaving and determines (together with the light barrier at the entrance) the number of visitors remaining in the room. Whenever the number of visitors in the room has decreased, wall video displays are turned off. Video displays are turned on, up to a maximum number, whenever the counter (i.e. the light barrier) at the entrance determines an increase in the number of persons in the room. Changing the number of "active" video displays is intended to bring more action to the walls with the video monitors.

The Tactile Room

In the Tactile Room a number (eight in Fig. 5.1) of tactile exhibits are on display. To attract the visitors' attention, a spotlight, aimed at the exhibit, is switched on when a person is near it (Fig. 5.1d). Simultaneously to the spotlight being switched on, an announcement, introducing the exhibit, is heard from a loudspeaker next to it. A visitor, whose attention has been caught and therefore approaches the exhibit, is detected by proximity sensors which are in the wall behind it, oriented horizontally. When the visitor stretches out his/her hand to touch it, the hand is detected by a proximity sensor positioned above the exhibit and "looking" down onto it. The trigger of this sensor starts a sound track which helps to interpret the tactile impression.

The Visual Room

The distinguishing feature of the Visual Room is that images displayed on large video screens can be manipulated by stepping on to pressure mats. Some of the more common processing functions, also called filters, are:

Zoom:	magnifies the original (or source) image,
Inversion:	reverses grey tones and colours,
Contrast:	changes the contrast from normal to high,
Mirror:	mirrors the image about a horizontal, vertical axis or both,
Colour:	alters the intensity of the red, green and blue image components,
Edge:	detects edges and lines in and between objects,
Dots:	creates newspaper-like images, consisting of varying sized dots,
Pan:	scrolls a zoomed image up, down, left, right,
Blur:	blurs images, makes them diffuse looking,
Noise:	introduces disturbances and degrades visual information.

The last two filters can be used to give normally sighted persons an impression of the difficulties persons with visual impairments experience when they look at images that are undisturbed and can be clearly recognised with normal sight. Examples of the results of the first six filters, which are used in the test scenario in chapter 5.4, are shown in Figure 5.2.

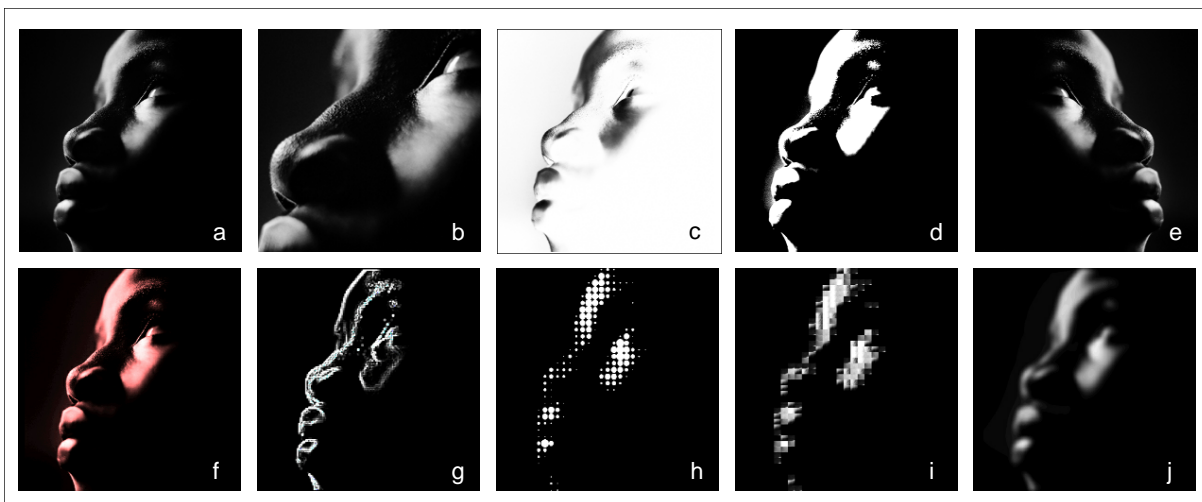

Fig. 5.2: Results of processing an image with different filters.
 a) original, b) zoom, c) inversion, d) contrast, e) mirror, f) colour, g) edge, h) dot, i) tile, j) blur.

Some of the mats can be reserved to trigger different sounds. All mats have differently textured surfaces that make them distinguishable for blind and partially sighted people. With the textured mats the partially sighted visitors can observe the image changes brought about by their interactions with the mats on the floor – in a similar way to sighted visitors.

5.2 Hardware and Software for Test Scenarios

To demonstrate that functioning interactive installations can be set up with the tool-kit, installation scenarios had to be devised that were complex enough to provide a challenge and prove the power of the tool-kit convincingly, but at the same time low-cost. A test installation with nine sensors (that trigger both images and sounds) was deemed to be complex enough to be able to prove the attractiveness of interactivity and the stability of the control programme.

The sensors do not have to be of different types because the sensor messages, from which the control programme derives its output actions, are identical for all the sensors that behave like on-off switches. Pressure mat sensors are used for the test installation because they are the most versatile of the sensors described in chapter 3.2; they can detect presence or absence, position and even movement. The pressure sensors act like switches: there is an "off" message when no pressure is applied, and an "on" message when pressure is applied.

The pressure mats were not bought from the firm that supplied the digitizer and interface (chapter 4.2) but from a supplier of home security systems where they only cost a fraction and, moreover, were available in different sizes and forms. These mats were not 'plug-and-play'-compatible with the digitizer and had to be prepared to be used for the tool-kit. Details of these preparations are given in Appendix C.

The first test scenario is intended to show that with one computer, sensors can trigger only two different images simultaneously. The last test scenario demonstrates that two networked computers can output four images and sounds in parallel (chapter 4.3). The limiting factor is not the control software but the

computer hardware, the video card and the sound card. The original video card of the Macintosh computer used could only handle one image output and was replaced by a "Dual Head" video card (chapter 4.4) which could handle two images independently. Multi-channel sound was not demonstrated (in order to keep the costs of the test scenarios low). The original one channel sound output of the Macintosh computer was therefore not augmented with a multi-channel sound card.

5.3 Test Scenario with Simple Interactions

The installation of the first test scenario is managed by one computer which controls nine pressure mats, two independent video outputs and one sound output. The nine pressure mats are put on the floor in a 3x3 matrix covering an area of about 3 by 3 metres. The arrangement of the mats and the numbering of the mats, which is only used for easier description of the installation, is shown in Figure 5.3a.

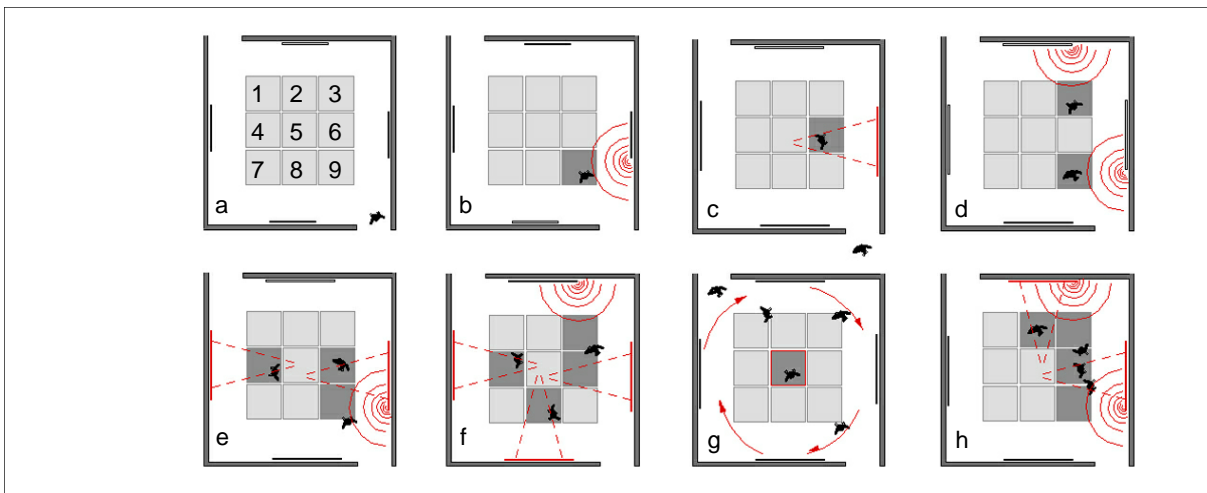

Fig. 5.3: *Test scenario with simple interactions.*
a) numbering of pressure mats, b-h) different interactions of visitors

Stepping on one of the centre side mats (number 2, 4, 6 and 8) triggers the projection of an image onto the wall nearest to the mat. The image belongs to one of the four image themes stored in the control computer. If the person stays on the mat, the contrast of the displayed image changes gradually from its initial level to a maximum level when the image becomes abstract and contains only intensely coloured areas, see Figure 5.4. Whenever a mat is stepped on repeatedly, the corresponding image changes. The projections can be triggered one after the other by one person or by several persons.

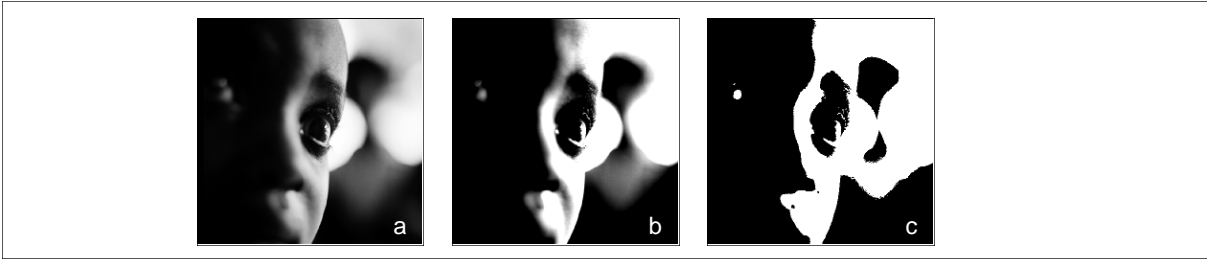

Fig. 5.4: *Image with different contrast levels.*
 a) Original image, b) Image with intermediary contrast level, c) Image with maximum contrast level

Stepping on one of the corner mats (number 1, 3, 7 and 9) triggers an audio output. Each mat corresponds to a different sound track with speech that describes a particular scene, such as a school scene in England or in Sierra Leone. If the person stays on the mat, more and more background sounds are gradually mixed with the main speech track. When the control computer is equipped with a multi-channel sound card, different background sounds can be played on different loudspeakers, thus enabling "spatial audio".

The centre mat (number 5) influences all image and sound outputs. Stepping on this mat causes all projections, visible at the time, to move to the next screen in a clockwise fashion and to be magnified at the same time. The audio description fades away and only the background sounds are heard.

Tests with the above described scenario revealed that test persons found the scenario not very intriguing and also rather confusing when they did not know the 'rules' beforehand. The confusion was even greater when several visitors interacted simultaneously with the installation. It was confusing for a visitor to have to remain in one place (on one sensor) for some time to be able to see, hear and comprehend the gradual changes in the image and audio. If one or several persons walk about on the sensors, a new image or sound is displayed every time a new mat is triggered, and there is not enough time for the visitor to observe the gradual changes in the image or audio track.

The test results from this scenario were taken into consideration in the design of the next scenario.

5.4 Test Scenario with Sophisticated Filters

One test result from the first test scenario (in chapter 5.3) showed that the possibility of triggering four images and audio tracks simultaneously, i.e. eight different scenes, was not well accepted by the test persons because they found it confusing and not controllable. The other test result was, that stepping on an "image" mat and only triggering an image change was not very interesting.

As a consequence of these results, the control programme was altered in two ways. Firstly, the number of output scenes was reduced by omitting audio, and secondly, the images displayed on the four walls could be processed with different filters, activated by pressure mats. An example of an image and three variations, which are obtained by filtering the original in different ways, is given in Figure 5.5.

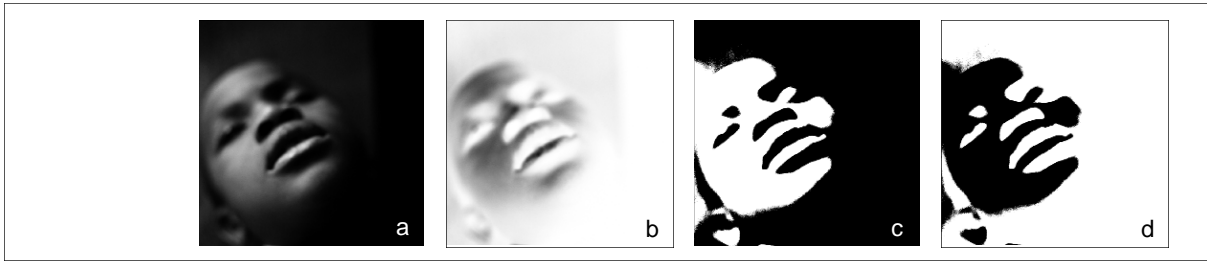

Fig. 5.5: *Initially displayed images.*
a) original greyscale image, b) inverse greyscale image; c) contrast image; d) inverse contrast image.

The initial displays on the four walls always consist of an image original as well as its inverse, contrast, and inverse contrast version. The image that is used for the initial display is selected randomly from the set of images stored in the control computer. When a visitor steps on any pressure mat, all four displayed images are processed with the filter corresponding to that particular mat. In this way another set of four different images is obtained and displayed.

The correspondence between the pressure mats and the triggered image procession operations is:

Sensor 1:	colour
Sensor 2:	dots
Sensor 3:	blur
Sensor 4:	contrast
Sensor 5:	take next image form the stored set of images
Sensor 6:	edge
Sensor 7:	mirror
Sensor 8:	inversion
Sensor 9:	zoom

To make the filtering operations more interesting and playfully entertaining, the filters are not applied to the images displayed initially but to the filtered versions that have been produced so far; one could say the filters are "adding up" with every new mat triggered. The interesting effect of these filtering operations is that the same filters, applied in different orders, result in different processed images. An example is shown in Figure 5.6 where one of the processed images is obtained by applying first the edge-filter and then the dot-filter, whereas the other image is the result of using the filters in reverse order.

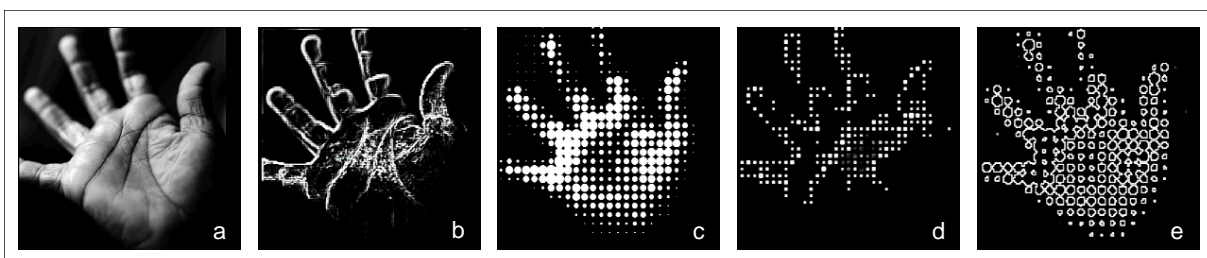

Fig. 5.6: *Effects of filtering order.*
a) original, b) only edge-filter, c) only dot-filter,
d) first edge-filter then dot-filter, e) first dot-filter then edge-filter

With the effects of the filter operations just described, a degree of interaction complexity is achieved that is neither too easy nor too difficult for understanding how the system works. If visitors take a systematic approach, they can find out the logic behind the interactions and get satisfaction from it. Less inquisitive visitors can just enjoy the surprising outcomes of their interactions.

This scenario was also set up and produced positive results. They showed that the aim, namely the elimination of the two drawbacks of the first test scenario (in chapter 5.2) was achieved.

6 TEST OF TOOL-KIT PROTOTYPE

With the experience gained from the test installations in chapters 5.2 and 5.3, the software components of the tool-kit, especially the control programme, were revised with respect to performance and stability. This tool-kit version has been developed to such a degree that it is now not only a demonstration model but can be viewed as a prototype which is ready to be reproduced for real-life applications and be used as a base system from which variants can be produced.

To prove the good performance and stability of the tool-kit prototype the final test described below was carried out under real-life conditions, i.e. with varying numbers of users that were not given any instructions how to interact with the system.

6.1 Test Scenario

The test scenario for the prototype is that of chapter 5.3 with an extension to the control programme that changes images automatically after the elapse of a pre-set time if nobody moves on the pressure mats. This automated image change is intended to attract more attention when the installation is not in use.

The programme extension sets timers with different time limits for each sensor. In this way the sensors are triggered automatically whenever their individual time limits are surpassed. The triggers cause the latest set of four images to be processed and displayed. The automated triggering procedure is interrupted or cancelled every time someone steps on a mat.

6.2 Equipment for Tool-Kit Prototype

The basic tool-kit system is described and depicted in chapter 4.1. For the test of the tool-kit prototype the following equipment was used (Appendix D):

- Floor pressure mats as sensors.
Simple electronic circuits had to be added to these inexpensive mats to work with the digitiser (chapter 4.2); the circuits and the necessary hardware are described in Appendix C.
- Two linked Macintosh G4 computers with 'Dual Head' graphics cards (chapter 4.4).
- Four digital video projectors.

The pressure mats and the wires leading to the digitiser were taped to the floor and not covered, in order to be clearly visible to the test persons, Figure 6.1. Mats covered with differently textured materials, as described in chapter 5.1, were not used for reasons of cost and time. The fact that the mats could easily be seen enabled the audience to discover the link between a particular position in space and the corresponding filter operation.



Fig. 6.1 Pressure mats and wires taped to the floor(left); test person on pressure mat (right).

For the display of the four independent images, two computers were needed, each one being equipped with a 'Dual Head' video card (chapter 4.4). The two computers were linked via a network which enabled the co-operation of the computers, Figure 6.2. This networking allows even more computers to co-operate if more images have to be displayed. The "master" computer receives the sensor data from the MIDI interfaces and sends relevant data to the "slave" computer(s).

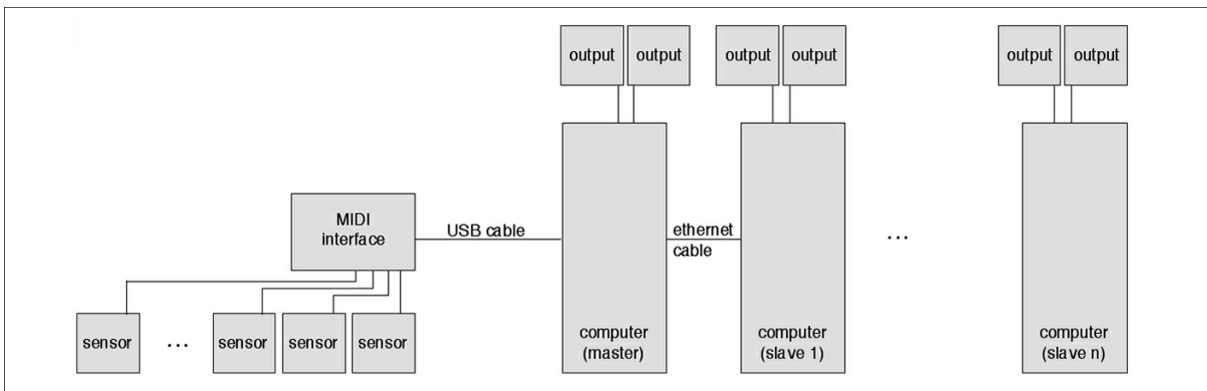
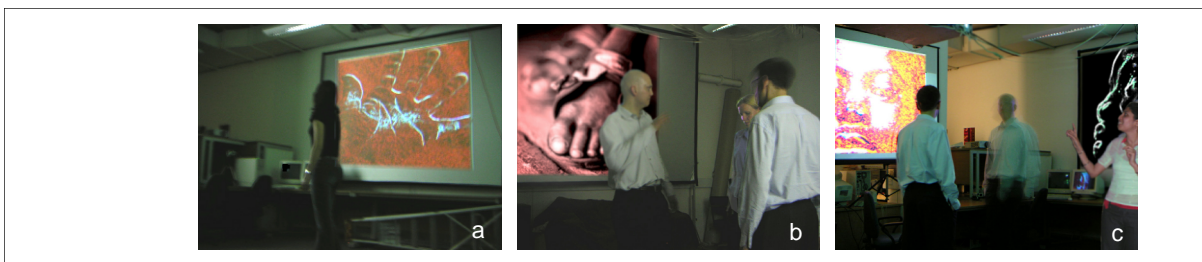

Fig. 6.2 Block diagram of the tool-kit's computer network.

6.3 Real-Life Test of Prototype

Before the tests the participants were given the questionnaire (Appendix E) which sketched the purpose of the demonstration installation but gave no instructions on how to interact with the system or what to expect. The intention had been to test the prototype with partially sighted students from a blind school where photos for Tim Hetherington's [Hetherington, 2004a] documentary on blindness were taken. This could not be arranged at the time, so tests were carried out with normally sighted participants.

Some people explored the system on their own until they understood how it worked (Fig. 6.3a). Others interacted with the system in a group and discussed the system's responses and their further interactions (Fig. 6.3b). A few test persons observed the interactions and reactions of others before embarking on a trial themselves. Questioning them revealed that they wanted to plan beforehand how to go about exploring the system.



*Fig. 6.3 People exploring the interactive installation.
a) a single person interacting on his/her own, b+c) a group exploring the system together*

The actions of the test persons revealed that the system responded as expected: the more persons interacted with the system simultaneously, the more unpredictable the system response became and the more difficult was it to understand which person triggered which sensor. One group of test persons enjoyed the "surprises"; another group preferred predictable responses. A conclusion from these observations was that not more than three visitors should activate the sensors simultaneously to be satisfactory for most people.

Some participants commented on the noticeable time delay between their interaction and the system's response. This delay only occurred when many sensors were triggered, either sequentially or in parallel. It has to do with the way in which the control programme ISADORA (chapter 4.3) works, and can be omitted by upgrading the computer processing power or, if this is not wanted, by limiting the number of filtering processes.

6.4 Evaluation of Questionnaire

About half the test persons filled in questionnaires after experiencing the installation. They were asked what they liked or disliked about the scenario and what their general impression was. The questionnaire and a quantitative evaluation of the returned forms can be found in Appendix E. A summary of a qualitative evaluation of the most frequent answers and statements is given below.

All participants liked the installation scenario and enjoyed interacting with it. The favourite installation features were the interaction with a responsive system and the playful discovery of its possibilities and surprising (visual) outcomes. The use of multiple large-scale projections showing variations of the same image simultaneously was also mentioned positively. Most would welcome such installations in exhibitions and museums.

The least liked aspect was that the pictures grew too abstract, meaningless and confusing when more than three persons interacted at the same time. The confusion originated partially from the response delay which is caused by many people interacting at the same time (see end of chapter 6.3).

Some people would have liked to go back to previous pictures if the result of the last filtering was unsatisfactory. This is a function that should be built into future systems.

The test group was divided in their opinion on whether the mats should carry labels or icons which indicate the function triggered by the sensors. A decision for or against labelling will probably depend on

the intention of an installation: labels for more educational installations, no labels for more entertaining installations.

Nearly half of the people would have liked audio as well, which is surprising since all visitors were normally sighted. If even fully sighted people feel that audio would enhance the installation experience, it will be all the more important for partially sighted visitors.

Most test persons felt that they were in control of the images that were produced when only few people were on the mats. They understood the correlation between their positions on mats and the resulting images, and found interacting with the installation generally user-friendly and intuitive.

7 CONCLUSIONS

Recent research by the Royal National Institute of the Blind about accessibility to museums, galleries and heritage sites revealed that, although partially sighted and blind people "*get life enhancement from experiencing exhibitions independently*", currently they cannot move freely through exhibitions "*without having to rely on intermediaries*".

The aim of the project, described in this thesis, was to develop a tool-kit for setting up interactive installations that would improve access for visually impaired people by considering their human factors, giving them more freedom of movement and independence in experiencing exhibitions. Furthermore, the tool-kit was required to be flexible enough so that it could be adapted easily to a broad range of interaction scenarios, and also low-cost so that it would be attractive for exhibitions with moderate budgets.

The project goals were reached by developing a computer-based, versatile tool-kit for interactive installations using commercially available components which can easily be exchanged in a 'plug-and-play' manner so that system adaptations can be made without much technical knowledge.

Exhibitions with interactive installations enable partially sighted and blind visitors to move freely through the exhibition space and interact with the installation without the need for assistance. Sensors detect the visitors and their movements and initiate responses which are presented to the visitors in the form of large images, spatial sound, light or other effects. There is a wide range of sensors and output devices available to suit the ergonomic requirements of visually disabled people.

The functionality of the tool-kit prototype was proven by testing an exemplary installation under real-life conditions with normally sighted participants. The installation used pressure sensors as input devices and multiple, large-scale projections as outputs. The test persons gave very positive feedback which included the opinion that such interactive installations in exhibitions would enhance the experience not only for normally sighted people but also for partially sighted persons. Tests with visually disabled people have still to be carried out.

Another test outcome was that nearly half of the test persons would have liked audio as well, which is surprising since all visitors were normally sighted. This outcome is very important since it clearly indicates that, if even fully sighted people feel that audio would enhance the installation experience, it would be all the more important for partially sighted visitors. The possible improvements of sound installations for visually impaired people have yet to be investigated.

8 FURTHER WORK, TOOL-KIT EXTENSIONS

The positive test results, obtained with normally sighted participants, must now be confirmed by partially sighted test persons. Then there are two major areas for extensions

- extending the tool-kit itself,
- extending existing exhibitions with the tool-kit.

The tool-kit has only been tested with single channel audio output. Therefore the tool-kit has to be extended with suitable hardware (sound card) and software (driver) to be able to output multi-channel audio. This is important for spatial audio and for providing several visually disabled visitors with different audio information simultaneously. Visitors receive information about the exhibits to which they are nearest. The experience of exhibitions could be further enhanced with spatial audio from which both visually impaired and normally sighted people would profit. Spatial audio lends itself to creating sound landscapes ("soundscapes") as a feature in its own right, or to complementing exhibition narratives.

Besides audio the other important information channel for blind people is their tactile sense. The tool-kit can be extended to provide tactile information with computer controlled Braille lines or arrays. The advantage of dynamic Braille information, controlled by computer, is that this information can more easily be changed or updated than fixed Braille text or images on information boards. Computer controlled Braille text lines and interfaces are commercially available.

Further work is also needed to gain experience with other sensors like proximity and motion sensors. The impact of their physical characteristics (e.g. field of view and sensitivity) on the installations has to be understood in order to make optimal use of them. Also the user-friendliness of installations with different sensors should be investigated.

Another extension of the tool-kit could be wireless transmission (e.g. with bluetooth) of data between the sensor interface and the control computer on the one side, and the control computer and the output devices on the other side. This could reduce cabling and make the tool-kit even more flexible.

As already mentioned, another direction of further work is to combine tool-kit installations with existing online exhibitions such as the British Museum's COMPASS or the Tate Modern's i-Map. These exhibitions, which use a computer keyboard and mouse as input devices and computer screens and displays as output devices, can be set up with tool-kit installations in exhibition rooms and use sensors as input devices and large screen displays or digital projectors as output devices.

For both COMPASS and i-Map this means linking the tool-kit to the database with the exhibit images and replacing the conventional computer input and output devices with the tool-kit's input and output equipment. These installations would enable visually impaired visitors to experience the exhibitions independently in museum and gallery rooms without having to rely on intermediaries. Image manipulations, like zoom or contrast enhancement, that were available in the old system can now be controlled by visitors

through interacting with sensors instead of using a computer keyboard and mouse. An additional benefit is that the images are not viewed on computer screens but on large scale displays.

In the case of i-Map, some of the tasks, which were carried out by humans to provide the simplified picture elements, could possibly be performed by the tool-kit's image processing functions. Some simplified elements like the contour lines of colour objects (e.g. person) can often be generated automatically from the original image with contour extraction filters. Automatically extracted contour lines can be seen in Figures 5.2g and 5.6b.

Generally speaking, interactive installations can always be used as "man-machine-interfaces" for image databases which are at the heart of virtual exhibitions.

9 ACKNOWLEDGEMENTS

I want to thank Tim Hetherington for initiating the project, providing the funds to buy the necessary equipment, and keeping a keen interest from beginning to end. This project offered me the freedom to be creative and develop new solutions.

Special thanks to Bruno Martelli who provided help whenever needed, despite the little time he had; with his support it was possible for me to become familiar with the ISADORA software in the short time of the project.

Many thanks to my project supervisors Cristiano Bianchi and Lesley Gavin for their encouragement and advice.

I am grateful to my fellow students, friends, and to those people who have shown an interest in my work and who took part in testing the prototype installation, giving such positive feedback and making many helpful suggestions.

I want to dedicate this thesis to my parents from whom I learnt that being curious and determined can be very enjoyable and rewarding. Their moral support and belief in me give me the strength to pursue and achieve my goals.

Contact Details

n.krause@ucl.ac.uk

nicola-krause@web.de

10 APPENDIX

Appendix A – MIDI interface standard

MIDI, the Musical Instrument Digital Interface, is a standard for communications between electronic musical instruments. The standard defines the hardware interface (type of connector and wire, and voltages/currents) and the communications protocol to be used [ROTHSTEIN, 1992; RUMSEY, 1990; BRAUT, 1993].

MIDI is a serial interface which has the

advantages

- simple connectors and cabling
(requires only one communications channel, one pair of wires)
- possibility for low cost

disadvantage

- generally slower than a parallel interface

It uses an *asynchronous* serial communication which means that the sending device usually sends nothing except a single serial data stream, expecting the receiver to lock onto the incoming data whenever it arrives. The locking-on is achieved by start and stop bits which precede and succeed every bite-long data word. This type of communication makes it very easy to interlink devices, since it only needs a single wire for the data (plus one return).

The MIDI interface is *uni-directional* with a maximum data transfer rate of 31.25 kbaud, that is 31,250 bits per second and fairly fast for a simple serial interface.

The connectors used for MIDI interfaces are like the five-pin DIN plugs used in some hi-fi systems. Only the innermost three pins of a five-pin DIN plug are used, and the cable should be a shielded twisted pair. It is recommended that no more than 15 metres of cable is used for a single cable, longer distances can be reached with ‘booster’ (amplifier) boxes.

MIDI equipment has three interface connectors: IN, OUT, and THRU. The OUT connector carries data which the device itself has generated, the IN connector receives data from other devices, and the THRU connector is a direct relay of the data that is present at the IN. The THRU socket can be used to ‘daisy-chain’ MIDI devices, so that transmitted information from one device can be sent to a number of receivers without the need for multiple outputs from the sending device.

An important MIDI concept (which is used by the sensor interface and the ISADORA control programme) is that messages can be made device-specific, i.e. a device will act only on messages with its own address and will ignore all other messages. This device selection is carried out by specifying in each message one of the sixteen MIDI channels.

Appendix B - MIDI Compatible A/D Converters

The list below shows companies that deliver MIDI A/D converters (digitisers).

Company	Product Name	Company's Website
Infusion Systems	I-CubeX	http://www.infusionsystems.com
Doepfer Elektronik	PE Universal MIDI Control Electronics	http://www.doepfer.de/pe.htm
Eroktronix	Midi Tron	http://www.eroktronix.com
La Kitchen	Toaster	http://www.la-kitchen.fr

Appendix C - Circuitry for Pressure Mats

The pressure mats function like switches which are open when no pressure is applied and closed when pressure is applied. The mats cannot be linked directly to the digitiser because the closed switch would cause a short circuit and damage the digitiser power supply. To stay within the digitiser specifications of 5 V and 30 mA a limiting resistor of at least 170 Ω has to be put in series with the switch as shown in Figure C1. In order not to strain the digitiser power supply, a resistor of 10 k Ω was chosen.

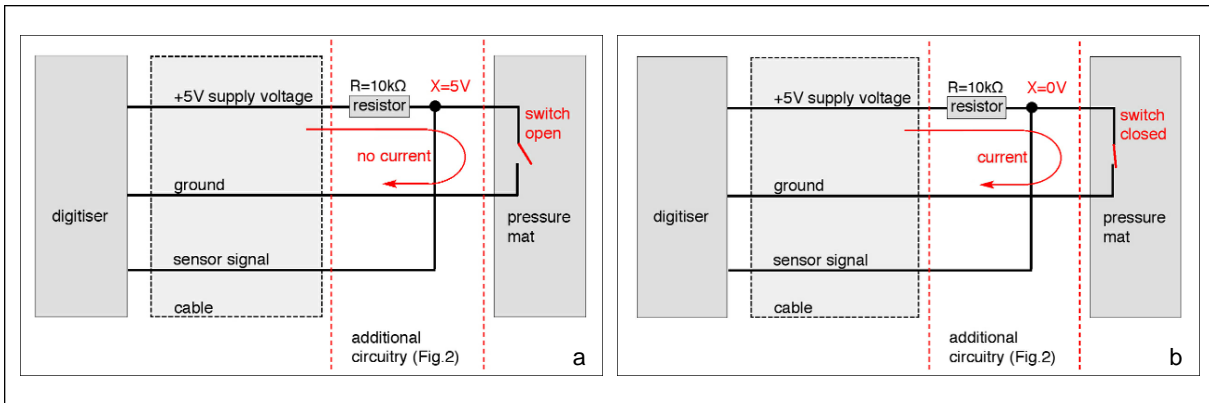

Fig. C1 Circuitry for pressure mats.
 a) no pressure applied to mat, b) pressure applied to mat.

Figure C2 shows the resistors and how they are soldered to the wires of the cable leading to the digitiser.

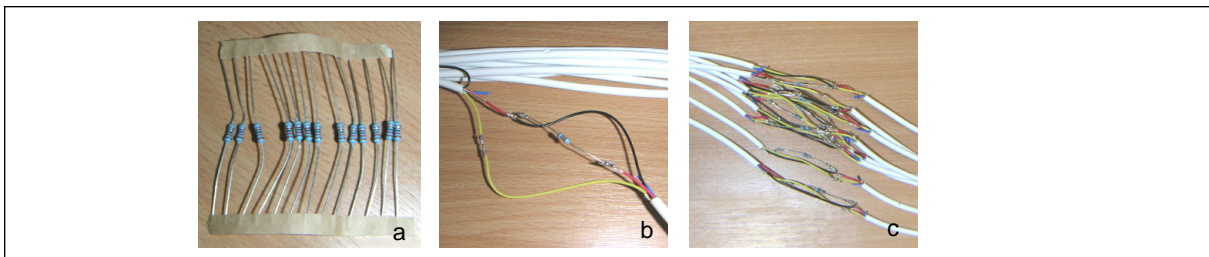

Fig. 2 Additional circuitry with resistors .
 a) resistors used, b) circuit for one pressure mat, c) circuitry for several pressure mats.

Before the cables were connected to the digitiser ports (input sockets), the supply voltages of the digitiser were checked with a Multimeter, Figure C3a. A similar measurement was carried out across the open switch (Figure C3b), between soldering point X in Figure C1a and the ground wire.

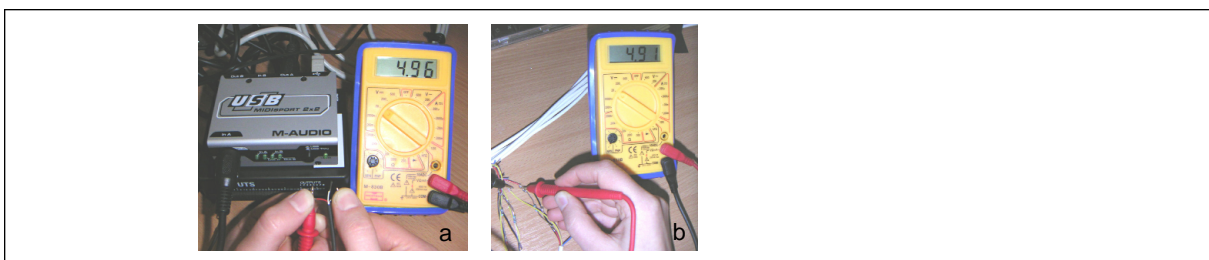

Fig. 3 Measuring voltage with multimeter.
 a) digitiser supply voltage, b) voltage across open switch.

Appendix D - Tool-Kit Hardware and Software Components

Item	Amount	Description	Distributor	~ Price £
Macintosh G4	2	OS 9.2		
Pressure Mats	9	'Tap Tile'	InfusionSystems	457.00
Cable	~70 m	4 Core Alarm Cable		20.00
Cables		2 MIDI cables 1 USB cable		15.00
I-CubeX	1	Digitiser	InfusionSystems	364.00
MIDISport 2x2	1	MIDI hardware interface	InfusionSystems	54.00
Graphics Cards	2	2 Radeon 9000 PRO MAC Edition, 128 MB (AGP)	ATI	168.00
ADC to VGA Adaptor	2	ADC Graphics Card output to VGA Projector Cable	Griffin Technology	52.00
Projector	4			
Isadora	1	Control Programme	Troika Tronix	155.00

Appendix E - Questionnaire Evaluation

15 Questionnaires Evaluated

QUESTION 1.

Did you like the interactive installation?

very

1

2

3

4

5

not

ANSWERS



QUESTION 2.

Would you like such an installation in exhibitions and museums?

very

1

2

3

4

5

not

ANSWERS



QUESTION 3.

What did you like most/ least?

most liked:

- interaction/ responsive system
- playfulness/ surprise/ discovery
- zooming into images
- multiple large projections/ 4 simultaneous versions
- multiplicity of outcome
- co-herent concept



least liked:

- confusion/ too abstract when many participants
- explanation needed
- not possible to go back to last image
- projections could have been even larger



QUESTION 4.

What would you change/ improve?

- include audio
- time-lag when too many filters active
- more feedback when triggering sensor

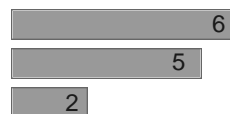

QUESTION 5.

Did you feel you were in control of the images and sounds?

very

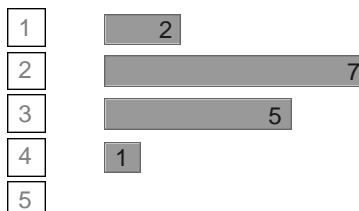

not

ANSWERS

QUESTION 6.

How obvious was the connection between your position and the images and sounds?

very

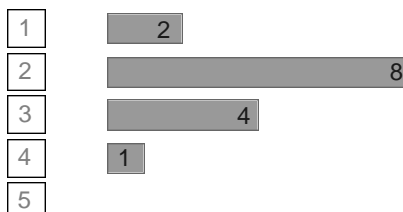

not

ANSWERS

QUESTION 7.

Could these interactions be called user-friendly and intuitive?

very

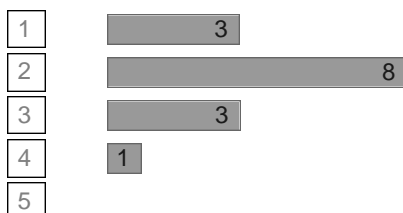

not

ANSWERS

QUESTION 8.

Did you prefer the "room" alone (1)/ with others (2)?



ANSWERS

QUESTION 9.

If you were with others did you coordinate your actions (to get system responses)?

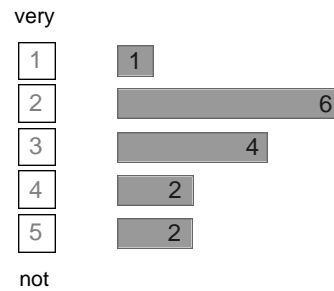

ANSWERS

- yes, system invites to do this
- finding an interaction consensus with strangers difficult
- difficult with more than three visitors
- group good to find new options



QUESTION 10.

Are you normally sighted(1), visually impaired (2), blind (3) ?

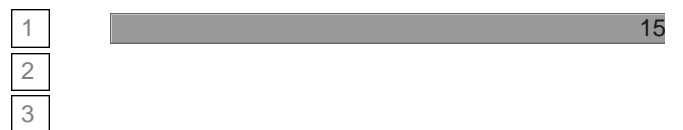

ANSWERS

QUESTION 11.

Any further comments?

- installation was fun and playful
- audio would have been an improvement
- labelling mats as explanation
- interaction alone first, then with group

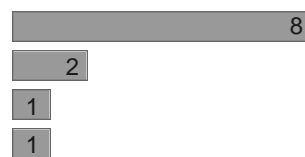

11 BIBLIOGRAPHY

10.1 References Used in Thesis

- ATI [2004] ATI, <http://www.ati.com>
- Bertrand [2003] 'Earth from the Air', <http://www.earthfromtheair.com/blind.html>
- Braut, C. [1993] 'Das MIDI Buch', Sybex, Düsseldorf, 1993
- British Museum [2001a] The British Museum, <http://www.thebritishmuseum.ac.uk/aboutus/about.html>
- British Museum [2001b] The British Museum, <http://www.thebritishmuseum.ac.uk/world/world.html>
- Compass [2001] 'COMPASS', http://www.thebritishmuseum.ac.uk/compass/ixbin/hixclient.exe?_IXDB_=compass&search-form=graphical/help/about.html&submit-button=search
- Coniglio, M.F. [2003] 'Isadora User's Manual, Version 1.0', <http://www.troikatronix.com/izzy-download.html>
- Hetherington, T. [2004a] <http://www.foto8.com>
- Hetherington, T. [2004b] 'Blind Link Project', <http://www.mentalpicture.org>
- Infusion [2004] Infusion Systems, www.infusionsystems.com
- Isadora [2003] Isadora, <http://www.troikatronix.com/isadora.html>
- RNIB [2003a] 'Talking Images Research: Museums, Galleries and Heritage Sites: Improving access for blind and partially sighted people.', Copies available by mail from cservices@rnib.org.uk
- RNIB [2003b] 'Talking Images Guide: Museums, Galleries and Heritage Sites: Improving access for blind and partially sighted people.', Copies available by mail from cservices@rnib.org.uk
- Rothstein, J. [1992] 'MIDI – a Comprehensive Introduction', Oxford University Press
- Rumsey, F. [1990] 'MIDI systems and control', Focal Press, London
- Tate [2002] The Tate Modern's 'i-Map', <http://www.tate.org.uk/imap/>
- Troika [2004] Troika Tronix, <http://www.troikatronix.com>

10.2 Project Background Study

Innovative Exhibition Concepts and Online Resources

- EARTH FROM THE AIR - general
<http://www.earthfromtheair.com/blind.html>
- EARTH FROM THE AIR - tactile images
Alain Mikli: www.mikli.com
- EARTH FROM THE AIR - Project Co-ordinator
Jane Nixey: janenixey@earthfromtheair.com – contact address
- FINNISH NATIONAL GALLERY – Exhibition "See, Hear, Imagine"
<http://www.fng.fi/fng/rootnew/en/vtm/palvelut-vn.htm>
- IDEE UND BILD - Hellmut Sitó Schlingensiepen, photographer
<http://www.ideeundbild.de/>
- IMPERIAL WAR MUSEUM - personal audio guide tours
<http://www.iwm.org.uk/education/holocaust/audio.htm>

NATIONAL PORTRAIT GALLERY - audio guides, sculpture touch trail, magnifying glasses
<http://www.npg.org.uk/>

PICTURES OF SOUND

A random audio-video interactive installation based on patterns generated by software and the movement of people around it. Infra-red sensors map the position of the audience and this data is used to interact with the video and the sound.

<http://www.picturesofsounds.com/>

TATE MODERN – Exhibition “i-Map”

Raised drawings, touch tours

<http://www.tate.org.uk/imap/>

TERRAFORMERS - computer game for sighted and visually disabled

The interface feature was awarded with the "Innovation In Audio Award" at the Independent Games Festival 2003.

<http://www.terraformers.nu/eng/features.php>

Institutions and Organisations Supporting Projects for the Blind and Visually Impaired

ARTS COUNCIL ENGLAND

is the national development agency for the arts in England, distributing public money from Government and National Lottery.

<http://www.artscouncil.org.uk/>

ART THROUGH TOUCH

organisation which aims to promote and provide access to art activity for people who are blind and partially sighted.

<http://www.art-through-touch.co.uk/>

DISABILITY DISCRIMINATION ACT

The Disability Discrimination Act (DDA) aims to end the discrimination which many disabled people face.

<http://www.disability.gov.uk/dda/>

DOG ROSE TRUST

is an innovative charity which works to make all environments accessible to people with visual and other sensory impairments. The Trust is committed to the use of Universal and Inclusive Design and Communication and the Multi-Sensory design.

<http://www.dogrose-trust.org.uk/>

MLA

The Museums, Libraries and Archives Council (MLA) is the national development agency working for and on behalf of museums, libraries and archives and advising government on policy and priorities for the sector.

<http://www.resource.gov.uk/>

MUSEUMS AND GALLERIES DISABILITY ASSOCIATION

is dedicated to improving access to UK museums and galleries for people with disabilities, disseminating current best practice, and providing a forum for museum and gallery professionals to discuss areas of interest.

<http://www.magda.org.uk/>

NATIONAL LIBRARY FOR THE BLIND

is a UK based registered charity and a leading agency in the provision of library and information services for visually impaired people. They house Europe's largest collection of Braille and Moon books and provide a free postal library service to blind and partially sighted people worldwide.

<http://www.nlb-online.org/>

RNIB - Royal National Institute of the Blind

<http://www.rnib.org.uk>

RNIB - Research

<http://www.rnib.org.uk/research>

Companies, Technology, Services and Products for the Blind and Visually Impaired

LIVING PAINTINGS TRUST

is a registered charity that offers a completely free service for visually impaired people. They produce specialist touch and sound packs that explain a wide variety of fun, interesting and educational pictures for those who cannot see.

<http://www.livingpaintings.org/>

NATIONAL CENTRE FOR TACTILE DIAGRAMMS

Design and production of tactile diagrams, maps and pictures (tactile graphics) in a variety of formats.

<http://www.nctd.org.uk/>

ORIENTATION AND INFORMATION SYSTEM

System is based on mobile hand held units and fixed information posts

<http://www.stakes.fi/tidecong/651kemm.htm>

SIGHT CITY EXHIBITION

A yearly fair focussed on products and solutions for blind and visually impaired in Frankfurt, Germany

<http://www.sightcity.de/>

VOCAL EYES

Britain's foremost audio-description service. A new area of activity has been the provision of audio guides with descriptions of paintings in visual arts exhibitions, for example at Tate Britain.

<http://www.vocaleyes.co.uk/>

Interactivity - Sensor Technology and Software Programmes

CONTRINEX - proximity sensors

www.contrinex.com

IGLOO DIGITAL MEDIAARTS

The Igloo group work with Isadora for their interactive art installations.

<http://www.igloo.org.uk>

INFUSION SYSTEMS

Their product 'I-CubeX' translates sensor signals with high resolution into MIDI messages. You can send these MIDI messages to MIDI-aware software programmes to control effects.

<http://www.infusionsystems.com/index.shtml>

ISADORA

is a graphic programming environment that provides interactive control over digital media, with special emphasis on the real-time manipulation of digital video.

<http://www.troikatronix.com/isadora.html>

MAX

software like Isadora

SENSOR TECHNOLOGY

<http://www.willow.co.uk/html/sensors.html>

Surveys, Reports and Publications

BUILDING SIGHT - A handbook of building and interior design solutions to include the needs of visually impaired people

Peter Barker, Jon Barrick, Rod Wilson, RNIB 1995

MOTION TRACKING - No Silver Bullet, but a Respectable Arsenal

Welch, Greg and Eric Foxlin (2002), IEEE Computer Graphics and Applications, special issue on "Tracking," November/December 2002, 22(6): 24-38.

www.cs.unc.edu/~tracker/media/pdf/cga02_welch_tracking.pdf

ON-LINE AND ON TARGET - art education, new technologies and sensory impairment

Caro Howell, Curator: Special Projects Tate Modern

www.bit-informationsdesign.de/download/EVA_Howell.pdf

RE-ASSESSING PRACTICE - visual art, visually impaired people and the Web

Caro Howell, Tate Modern and Dan Porter, Freelance Web Developer/Art Historian, United Kingdom

<http://www.archimuse.com/mw2003/papers/howell/howell.html>

TACTILE FOOTWAY - surfaces for the blind

Cristine Gallon, Philip Oxley and Barbara Simms, Viewpoint, October 1991, 45(201), 33-35

TALKING IMAGES CONFERENCE REPORT

http://www.rnib.org.uk/xpedio/groups/public/documents/publicwebsite/public_talkingimages1.hcsp

TALKING IMAGES RESEARCH PROJECT

LMAL – London's Museums Archives and Libraries

<http://www.lmal.org.uk/uploads/documents/>

VOCAL EYES REPORT - New Audiences Project 2001-2003

http://www.newaudiences.org.uk/downloads/vocaleyeyes_report.doc

WEB ACCESS TO CULTURAL HERITAGE FOR THE DISABLED

Jonathan P. Bowen, Professor of computing, FEST/CISM, London South Bank University

www.museophile.lsbu.ac.uk/pub/jpb/eva2003.pdf

WHISPER: A Spread Spectrum Approach to Occlusion in Acoustic Tracking

Vallidis, Nicholas M. (2002), Ph.D. dissertation under the supervision of Gary Bishop, University of North Carolina at Chapel Hill, Department of Computer Science.

www.cs.unc.edu/~vallidis/research/whisper.html