

A combined transient hygrothermal and population model of House Dust Mites in beds

S E C Pretlove¹, I Ridley², J A Horwood³, B Leung⁴, P Cox⁵, D Thomson⁵, N Baker³, D Crowther³, T Oreszczyn²

¹Faculty of the Built Environment, South Bank University, London, UK

²The Bartlett School of Graduate Studies, University College London, UK

³The Martin Centre, University of Cambridge, Cambridge, UK

⁴Department of Zoology, University of Cambridge, Cambridge, UK

⁵Medical Entomology Centre, Cambridge, UK

ABSTRACT

This paper describes a current multi-disciplinary UK funded research project aimed at developing a hygrothermal model of house dust mite response to environmental conditions. The project involves the development of a transient hygrothermal bed model, which has been tested and validated by comparing its predictions with the environmental conditions measured in a bed in a test laboratory and in beds in dwellings. A dust mite population model is currently being developed and is being tested by carrying out mite population growth studies in the laboratory, where environmental conditions can be controlled and measured accurately, and in dwellings. The aim of the project is to integrate the hygrothermal model with the population model so that assessments of the risks associated with dust mite populations in dwellings can be made. The combined model can also be used as a practical tool for examining how the dust mite microenvironments can most effectively be improved by changing the design and use of a dwelling.

INTRODUCTION

Allergens derived from house dust mite (HDM) faeces play a major role in allergic disease, especially in childhood asthma. The number of people affected is rising throughout the world, now impairing the quality of life of a substantial proportion of children (ISAAC 1998) and placing a significant and growing burden on health services. The role that HDM allergen plays in allergic disease has been extensively researched and reported (Platts-Mills and Chapman 1987; Lau *et al.* 1989; Mahmic 1998). The project described in this paper focuses on the process whereby HDM allergen comes to be in the home in the first place. In particular, it investigates the potential for controlling mite populations by environmental means, that is to say, by preventing the hygrothermal conditions they require to survive from occurring. The development of a combined HDM population model plus a hygrothermal micro-environment model allows the investigation of past and future environmental changes, such as higher internal temperatures or reduced ventilation, to be investigated.

MITE PHYSIOLOGY

Liquid water is not available to HDM and they generally gain little from food or passive sorption. Instead water intake is achieved by active extraction from unsaturated air via a hygroscopic secretion (Wharton *et al.* 1979). Water is simultaneously lost as a result of activity, such as reproduction, defecation and evaporation. The Critical Equilibrium Humidity (CEH) is the RH below which water loss is greater than water intake. As RH rises above CEH, feeding, defecating, mating and egg production all increase (Arlian 1992). Conversely, as RH falls below CEH, all activity reduces in order to minimise water loss. The further RH falls below CEH, the faster mites dehydrate and the quicker they die (the time required varies according to stage of life cycle and species). HDM can even recover from short-term severe desiccation if RH returns quickly above CEH (de Boer 1998). CEH varies with temperature, being lower at low temperatures (Arlian 1981).

For constant vapour pressure, ambient RH increases as temperature drops and thus CEH tends to be more easily achieved at low temperatures. However, as temperature falls, egg output slows and egg-to-adult development time increases. But temperatures have to remain below freezing for some time in order to kill adult HDM. Indeed HDM frequently prefer suboptimal temperatures for the sake of higher RH. However, mere survival at low temperatures is not necessarily sufficient for population growth. While low temperatures tend not to eradicate mites, they help to reduce proliferation. On the other hand, it is easier to eradicate mites at temperatures above the optimum range, both because RH falls (for constant vapour pressure) and because the CEH rises. Whether HDM populations increase thus

depends on the RH being above CEH and temperature being within the optimum range for a sufficient proportion of time, and, departures from optimum being neither too severe or too long-lasting.

Mite ecology

HDM feed on human skin scale and are found in those locations where it collects, in bedding, carpets, padded furniture and soft toys. Since we shed dead skin at a daily rate of 0.5 – 1.0g per person and several thousand mites can survive for months on just 0.25g (Korsgaard 1998), it is possible that HDM populations are not limited by food supply. However, food quality is also a factor, since it needs to be reasonably moist for HDM to be able to digest it (Bronswijk 1981). Feeding rates and therefore nutritional uptake and reproduction are thus affected if the moisture content of the food is not high enough. HDM populations tend to flourish in the presence of moulds and one explanation is that mould helps to break down (pre-digest) and soften the skin scale. Another explanation is that mites feed on mould and gain nutritional benefit (Asselt 1999). However, mould activity increases rapidly with rising RH and above about 85% mite populations decline as the food supply becomes contaminated by mould toxins (Arlan *et al* 1998).

The order of abundance of the three most common species of HDM, *Dermatophagoides pteronyssinus* (DP), *D. farinae* (DF) and *Euroglyphus maynei* (EM) within UK, Europe, Australasia and North America are shown in Table 1 (Bronswijk 1981).

Distribution

At the macro scale, regional differences in HDM numbers can generally be related to overall climatic conditions (Charpin *et al* 1988). Mite densities tend to be highest in warm humid climates, where outdoor humidity and temperature are near ideal for most of the year and it is difficult to avoid indoor conditions being equally ideal. Conversely, mite densities tend to be lowest in cool dry climates, where it is easier to achieve indoor conditions that are too dry even for the mite to survive.

However, hygrothermal conditions in the home are affected by several factors other than external climate especially, for example, occupant behaviour in relation to moisture production and ventilation habits. It is thus still possible to create conditions favourable to mites even in cool dry climates and it is not uncommon to find two apparently identical nearby homes, one with a high number of mites while the other has none, reflecting the different hygrothermal conditions in each case. Such high/low pairs, which are also found in temperate regions such as the Netherlands (Strien *et al* 1994), demonstrate the potential for controlling mite populations by environmental means.

Seasonal variations are also important. Even in cool dry climates, both the temperature and moisture content of outdoor air tend to be high at the beginning of autumn, and it is difficult to prevent near-ideal conditions for mites at this time. Many studies have shown that this is when HDM populations tend to be at their peak (e.g. Arlan *et al* 1983). But in winter, the cold outdoor air contains much less moisture, so that a well-heated and well-ventilated house can more easily provide the dry conditions that are inimical to them. Consequently too few survive to take advantage of the following autumn and the population declines. However, if there is inadequate ventilation over winter, humidity may remain high enough for HDM to survive and prosper. At high latitudes therefore, where the cold winters make the provision of warm interiors essential, it is likely that adequate ventilation in winter will be enough to control HDM populations. The Danish experience tends to support this view (Harving *et al* 1991).

In temperate climates, however, the situation is not so clear cut. Being less cold in winter, outdoor air is less dry and therefore less effective for lowering indoor humidity by means of ventilation. Mild winters also make good insulation and efficient heating less essential, so that bedroom temperatures tend to be lower (as is certainly the case in the UK). This is likely to help HDM survival in winter, because RH will then tend to be higher and CEH will be lower. This may explain why simply improving ventilation in such circumstances is not always found to be beneficial (Niven *et al* 1999). At the same time, temperate summers may not necessarily be as favourable to mites as generally assumed. In a study of Dutch dwellings, de Boer (1999) has found hygrothermal conditions in carpets on some winter days to be more favourable to mites than some summer days. He goes so far as to suggest that a poor summer, that is to say cool and dry, could be as effective in controlling HDM populations as a cold winter (at least with respect to carpets).

Aims and objectives of the research project

The possibility of controlling HDM populations by environmental means has been recognised for some time (Cunningham 1998). However, as indicated above, hygrothermal conditions within dwellings are the result of many interacting factors, many of them constantly changing over time and giving rise to transient effects. This is important because it has been shown that dust mites can survive and even prosper in conditions that are on average hostile, provided there are regular bouts of more favourable conditions (de Boer 1998).

A further complication is that the HDM microenvironment in bedding, carpets and upholstery is distinctly different from room conditions, although affected by them. This is particularly true of bedding, where there are large diurnal variations of both humidity and temperature as a result of human occupation. Mean room values are thus doubly unreliable in that they take no account of either transient effects or the differences between microenvironments and room conditions. This is unfortunate since it is mean room values that are most often used in studies to investigate the role of environmental variables in determining HDM population and allergen levels. Indeed in some cases, mean room RH alone is measured, ignoring the important role temperature plays in affecting mite growth. In large-scale epidemiological surveys, because of the number of dwellings required for statistical significance, monitoring mean room values is usually all that is feasible.

In other words, there is strong evidence that HDM populations could potentially be controlled by environmental means in many parts of the world, but it will not be possible to determine how best to achieve this until we can more accurately simulate hygrothermal conditions in mite micro environments, taking account of all the variables that influence them and the transient effects they give rise to, and relate these hygrothermal conditions to mite physiology so that the effect on mite populations can be predicted.

The objectives of the project described in this paper are thus:

- The development and validation of a transient hygrothermal bed model
- The development and validation of a house dust mite population model.
- The integration of the hygrothermal model with the population model.

LABORATORY EXPERIMENTS

Laboratory experiments are being carried out to provide data for developing and validating the hygrothermal and population models.

Environmental monitoring in the laboratory bed

In order to establish the typical environmental conditions within an occupied bed, and to validate the transient model being developed in this research project, a test bed was set up within an environmental chamber, which had a relatively stable internal temperature and RH compared to a typical bedroom. All of the test results presented here were carried out using an open cell latex single mattress on a wood slatted base and a synthetic hollow fibre quilt (thermal resistance of $1.24 \text{ Km}^2\text{W}^{-1}$). Different mattress types are currently being tested, including open sprung mattresses.

The test bed mattress was monitored for temperature and RH at 75 locations both at the surfaces of the pillow, covers and mattress and within the mattress depth. The environmental conditions within the environmental chamber were also monitored. The instrumentation used for monitoring the bed consisted of two Campbell Scientific 23 X micro-loggers with six thermocouple multiplexers. Type K thermocouples were used to measure temperature and the RH was measured using miniature Honeywell HIH3605A ceramic sensors. All of the sensors were set to monitor conditions every second and hourly averages were recorded. The bed was continuously monitored and volunteers were asked to sleep in the bed at night. The sensors were positioned on a 0.25m by 0.5m plan grid on the surface of the mattress, underneath the mattress sheet, resulting in a 5 by 5 grid of 25 sensors. At nine of these plan locations, down the centre of the mattress in both directions, sensors were also placed within the mattress at a depth of 0.01m from the top surface, in the centre of the mattress and at a depth of 0.01m above the bottom surface. Figure 1 shows the monitored temperature on the surface and within the mattress during one typical extended occupied period of monitoring at a location underneath the bed occupant. Figure 2 shows the monitored RH on the surface and within the mattress during the same period of monitoring. Figure 3 shows a plan of the monitored RH on the surface of the occupied bed for each of the 25 surface sensor locations, at 4.00am in the morning.

The results of the monitoring show that whilst the bed is occupied the top surface temperature conditions respond very quickly to the skin temperature required for thermal comfort. As a result, the RH at this surface reduces in relation to the RH of the ambient bedroom conditions. The temperatures found within the depth of the mattress start reducing rapidly below the top surface temperature as we reduce depth. Even at a depth of 0.01m under the top surface the temperatures are typically 8°C below that of the top surface. This significant reduction in temperature within the depth of the mattress allows the RH within the mattress to increase above RH of the bedroom air.

These results indicate the important role that both temperature and RH play in mite development. The dust mite is normally prolific in the bed, yet the average RH can be lower in the bed and the temperature significantly higher than the ambient bedroom conditions. It has also been shown in these tests that the RH and temperature at the top surface of the mattress can be significantly different just 1cm below this.

Mite Laboratory experiments

By contrast to hygrothermal monitoring, determining the transient distribution of house dust mites within bedding, even in the laboratory, is fraught with difficulty. By cutting a foam mattress into rectangular columns, de Boer (1990) has shown, for a particular moment in time, that mites can be found at various depths according to environmental conditions. However, such work is extremely time consuming and beyond the scope of the current study. Instead, we have focussed on finding answers to specific questions, which are important for developing the population model.

(a) Population Growth experiments

The house dust mite is unusual in that population growth appears to be relatively free of the normal constraints of food supply (this is currently being investigated), space and competition from predators. It is also most commonly assumed that there are no effective space or density constraints. However, for population modelling, the maximum density that a population can reach, or carrying capacity, is a fundamental variable that needs to be determined, if only to demonstrate that density restraints are irrelevant. Since, surprisingly, there is little experimental data on dust mite carrying capacity, the following experiments have been carried out.

Dermatophagoides pteronyssinus were obtained from laboratory cultures maintained at the Medical Entomology Centre in Cambridge. Mating pairs of males and females were selected from cultures and 2 pairs placed into each of 15 plastic 7.23cm³ vials. Approximately 1.5g of culture (50% dried liver, 50% yeast) was added to give a culture volume of 2.46cm³. The container openings were covered with a breathable fabric and secured with elastic bands to enable gaseous exchange, but prevent mites escaping. Containers were maintained at 25°C and 75% RH (ideal conditions for growth) and initially the culture medium was gently shaken daily to prevent coagulation.

At approximately 3 weekly intervals 10 randomly selected cultures were used to determine mite population density. A subsample of 0.1g of culture was removed, placed in a gridded petri dish and the number of mites counted. From this the total number of mites per tube was estimated. Following counting the culture and mites were returned to the container. At 62 days the sample size was reduced to 0.05g due to the high number of mites present.

From Figure 4 it can be seen that there was an increase in the mean number of HDMs from the initial 4 mites at day zero to a maximum of 1226±131 mites per 0.1g culture at day 126. This initial growth of the HDM population was sigmoidal and fits closely to that which would be expected under the density dependent model. If this were the case then the upper asymptote will represent the carrying capacity (K). Following the peak in numbers there was a decline in the population to 1179±115 mites per 0.1g culture. However, this may be due to the population size stabilising around the carrying capacity.

If space, rather than food were the limiting factor in the above experiment then this data may be used to estimate the number of mites which a mattress could potentially support. A single mattress has dimensions of 200 x 90 x 20 cm, giving a volume of 360000cm³, of which approximately half would be suitable for the HDM to live in (180000 cm³). If it is assumed that there are no limiting factors in the above experiments and the carrying capacity has been reached then a volume of 7.23cm³ can support a population of 20311 mites. It therefore follows that a single mattress may be capable of supporting a population of over 500,000,000 mites.

This experiment is ongoing, along with further work using various volumes of culture and container to determine whether it is space, or food which is limiting.

(b) Transient condition experiments

Most of the data for mite physiology and population dynamics has been obtained under steady state hygrothermal conditions, whereas in real life conditions in the mite's microenvironment are constantly changing. Andrews et al (2000) conducted one of the few studies to investigate transient conditions, albeit over a maximum of seven days. Using a computer controlled incubator, they subjected mites to the same regime of varying hygrothermal conditions as Cunningham (1998) had found in his study of bedding, carpets and upholstery. We intend to carry out similar experiments, using as input data the conditions generated in the laboratory bed experiments described above. In this way we hope to fill in some of the gaps in the data available for developing a population model.

(c) Mite Box experiments

Very little is known about house dust mite movement or the extent to which mites travel within their microenvironment in order to find the most favourable locations. Within bedding, for example, there are wide diurnal fluctuations in temperature and RH, the most favourable locations for mites constantly shifting.

If dust mites can sense changing hygrothermal conditions and move relatively rapidly in response to changing environments, they may be able to find the best locations within their microenvironment. On the other hand, if they cannot move far or quickly enough, this would have important implications for both the microenvironment and population modelling. In the former case, it would be sufficient to know only that hygrothermal conditions were favourable somewhere within the bedding, but not necessarily where or how mites get there. In the latter case, by contrast, a much finer spatial 3-dimensional grid will be required in order to simulate the dynamic interaction between changing conditions and a slowly shifting distribution of mites.

In order to determine how mites move to changing environments a specially designed mite box has been constructed with two identical elongated chambers, one instrumented, the other not, as shown in Figure 5. The box has been milled out of aluminium alloy and is surrounded by insulation with a double glazed lid. A temperature gradient can be established by passing warm water through a hole drilled at one end and cool water through a hole at the other. With the glass lid in place, a rubber gasket seals the chambers so that the vapour pressure is held constant. The temperature gradient thus results in a matching RH gradient along the long axes. It is assumed that the conditions in the two chambers are the same.

Live adult mites are placed in the empty (uninstrumented) chamber and their movements are observed with a high-resolution digital camera mounted on a stand above. This is linked to slave flash units that capture an image at pre-set time intervals such as an hour. The digital images are then analysed (a mite occupies several pixels) in order to quantify the extent and speed of movement according to different temperature and humidity gradients. To date, most of the mite counting has been done by visual inspection, but automated visual processing techniques are being developed. The results of the first completed experiment are described below.

Mites were introduced into the mite box from a laboratory culture previously maintained at 75% RH and 25°C. Approximately 200 mites, generally similar sized adults, were placed into the box directly from the culture and in a roughly even distribution within the chamber. A temperature gradient was applied along the box giving a range of conditions from approximately 18°C and 90% RH at one end to 28°C and 50% RH at the other. The length of the mite box was divided into four sections and the number of mites in each section recorded at regular intervals. The same experiment was also conducted in the absence of an environmental gradient.

Preliminary results show that mites tend to move towards areas of high humidity and low temperature. Initially mites were evenly distributed throughout the box, but after 8 hours the four sections, from low to high humidity supported 7, 21, 34 and 38% of the mites respectively. A similar distribution was present after 24 hours, however when the gradient within the box was reversed mites began to move in the opposite direction, again towards the end with high humidity. Three hours after the gradient was reversed the four sections, from high to low humidity, supported 12, 32, 39 and 17% of mites and by 20

hours the sections supported 26, 38, 21 and 15% of mites. It would therefore appear that mites preferred to be in the regions of high humidity, despite a lower temperature.

At this early stage, there is clearly more experimentation to be done before definitive conclusions can be drawn. Nevertheless, these initial results suggest that mites can sense differences in humidity and do move away from dry conditions up a humidity gradient. On the other hand, the net movement of the population is not rapid, which suggests that a high degree of spatial detail will be necessary for the population model. Several variants of the experiment are being carried out, including putting food at different locations to see if this affects the results.

FIELDWORK

In parallel with the laboratory experiments, and in order to test the validity of the models, we are also carrying out a series of field studies in the bedrooms of project participants.

Environmental monitoring in dwellings

Detailed monitoring of the environmental conditions in the bedrooms of six dwellings has been carried out. Using Hobo H8 data loggers, manufactured by Onset Computer Corporation, half-hourly measurements of temperature and RH in three locations in each bedroom have been collected. The loggers were positioned in the bedroom away from the bed, in the bed between the quilt and quilt cover and directly underneath the bed mattress. A fourth datalogger was positioned outside of each dwelling collected simultaneous data for the external climate local to each dwelling. The manufacturer's quoted accuracy of these dataloggers is $\pm 0.7^{\circ}\text{C}$ for temperature and $\pm 5.0\%$ for RH. However, the new loggers were calibrated by the manufacturer before installation and all loggers read to within $\pm 1.0\%$ RH before installation. Figure 6 shows the temperature and RH monitored in a typical bed for four days in November 2000.

The results show that the temperature at the top of the mattress in a typical occupied bed is consistently between 34°C and 35°C , this being the skin temperature required for human thermal comfort. This bed temperature during occupation is consistent across a wide age range (the sample age of bed occupants ranged from 10 to 57), different bedroom conditions and different beds and bedding.

As found in the laboratory study, when the beds are occupied, the RH drops as a result of the increase in temperature. Once the occupant leaves the bed then the RH begins to rise until it reaches equilibrium with the surrounding bedroom air. However, there are variations in the collected RH data due to the fact that the beds were monitored at a single point within the bed and this was very sensitive to the bed occupant moving around (and often away from the sensor) during bed occupation. Data has been collected since August 2000 and will continue to be collected for at least one year. Average conditions in the beds of four of the participants during the first four months of monitoring are shown in Figure 7. Several of the monitored beds had frequent nights when the bed was unoccupied, which resulted in the variability in the average temperature and RH data collected.

House Dust Mite sampling in dwellings

Mite densities in occupied mattresses are normally sampled either by vacuuming the surface and counting the number of mites found in the collected dust, or by leaving 'mite traps', consisting of sticky paper, located on the outer surfaces for a period of time and counting the mites stuck to the paper. Although we are employing both methods, neither is wholly satisfactory since it is difficult to be sure that the sample is representative of the whole mattress, or that all mites are being removed. For example, it has been reported that adhesive tape may only recover 8-30% of mites seeded on fabrics (Colloff 1991) whilst vacuuming generally removes dead, rather than live, mites. However, it would be impossible to remove all mites from the entire mattress and by employing both methods it is hoped that a representative sample of both live and dead mites will be collected.

We are also developing a 'caged tube' method, using the same (or smaller) tubes as used for the laboratory population growth experiments (Section 2.2a). At this stage, tubes are located in participant bedrooms, but it is hoped to eventually place them directly into the mattress. Although the movement of the mites within the tubes is restricted they will nonetheless be subjected to real transient conditions and will thus provide data to test the validity of the population model.

TRANSIENT HYGROTHERMAL MODELING

A transient hygrothermal model has been developed which predicts hourly values of temperature and RH at a given Cartesian co-ordinate location within the mattress using user-input data relating to the fabric of the house, ventilation and heating schedules, local climate, bed type and hours of bed occupation. The transient model works in two stages; first it models the hygrothermal conditions within the bedroom and then it models the microenvironment within the bed. Existing software packages were used to carry out both of these stages.

The TAS/Umidus model

The simulation package used to determine the transient conditions of temperature and RH in the bedroom is TAS, produced by EDSL. This is a response factor model which enables the prediction of hourly environmental conditions within a building, given the thermal properties of the building fabric and external climatic data, including solar radiation. The thermal model has been tested as part of an IEA thermal model validation study (IEA 1994). TAS also predicts passive wind driven and buoyancy driven building ventilation once the flow characteristics of openings and air leakage paths have been specified. The internal RH is determined, using a simple mass balance calculation, from the zone temperature, external moisture content and ventilation rate. The main limitation of the model is it assumes zero building hygroscopicity (current work using Energy+ instead of TAS should overcome this situation). An output file containing 8760 hours of temperature and RH in the bedroom is generated for a year's simulation.

The modelling of the micro-environmental conditions within the bed is carried out using a coupled heat and moisture movement model called Umidus (Mendes et al 1999). Umidus accounts for both diffusion and capillary regimes, that is, the transfer of water in the vapour and liquid phases through the material can be analysed for any kind of climate. The model predicts moisture and temperature profiles within multi-layer elements for any time step and calculates heat and mass transfer. The Umidus model requires various hygrothermal properties of the mattress to be known.

The transient modelling of the mattress is carried out in a number of steps. Firstly the TAS model predicts the hourly average temperature and RH conditions in the bedroom for a full year. These conditions are assumed to be the boundary conditions at the base of the mattress, which has been shown empirically to be the case where the mattress is not sitting directly on the floor. The boundary conditions at the top of the mattress are determined using a spreadsheet calculation called PreUmidus which uses the output data from TAS and estimates the hourly values of the bed surface temperature and RH for five different zones on the mattress surface. The values of the temperature and RH within each of these zones are based on experimentally observed conditions during occupation of the laboratory bed. Once the bed is unoccupied, the boundary conditions start to change until they reach equilibrium with the ambient conditions in the bedroom. Experimentation has shown that each of these zones maintains a vapour pressure excess when compared to the vapour pressure of the room. TAS and PreUmidus therefore provide the boundary conditions at the top and bottom of the mattress and this data is then used by Umidus to determine the micro-environmental conditions of temperature and RH within the mattress. Because the model relies on fixed boundary conditions derived from laboratory measurements it is semi-empirical.

Figure 8 shows the zoning of the bed surface and the assumptions made regarding the surface temperature and the vapour pressure excess at each of these locations when the bed is occupied and the basic structure of the TAS/Umidus transient hygrothermal model is shown in Figure 9. Typical simulated conditions within a mattress at a vertical location below the bed occupant are shown in Figure 10.

Comparison of predicted and monitored conditions

Comparisons have been made between the transient temperatures and relative humidities measured on the top of the mattress within the beds and the same variables predicted by the transient TAS/Umidus hygrothermal model. For comparative purposes the input into the TAS/Umidus model consisted of the external climatic data, constructional data for the building plus occupant data relating to the use of ventilation and heating systems. PreUmidus has been used to model the conditions on the top surface of the mattress. TAS/Umidus simulations have been run for the period 1st to 12th September 2000, when the houses were unheated and for the period 9th to 17th November 2000, when the houses were heated.

The results of the comparisons between monitored and predicted data for one of the dwellings are shown below. Figure 11 shows the comparison between monitored and predicted data in the unheated dwelling and Figure 12 shows the same results for the same dwelling when it was heated.

The results show that the average hourly difference between predicted and monitored temperatures in the bed during the unheated period is 2.7°C and during the heated period is 3.0°C. The average hourly difference between predicted and monitored relative humidities in the bed during the unheated period is 6.8% and during the heated period is 5.2%.

The main discrepancies between the monitored and predicted bed conditions are the peaks in the monitored RH recorded during the bed occupation periods. It is possible that moisture production is highest in the first few hours of occupation and variability is also expected since only one bed surface sensor was placed within each bed and the occupant could easily have moved away from this single sensor during occupation. Alternatively this may be a sensor phenomenon and is currently being investigated. The simulated conditions also assume that the bed was occupied each night between 10pm and 7am and in reality this is variable.

POPULATION MODELLING

Simple models are inherently valuable for their speed, ease of use and general applicability. The simplest form of population model is to relate overall population size to mean hygrothermal conditions. However, mean conditions are unlikely to be a reliable indicator of mite growth. Complex models of house dust mite population dynamics do not yet exist, and it is difficult to determine a priori the optimum level of complexity required to obtain results of the desired accuracy. The preceding section has demonstrated one method of identifying the detailed micro-environmental conditions within a bed. However, these must somehow be related to mite faeces production if the data is going to be useful for developing appropriate strategies for asthma control.

The Mite Index

Previously, most environmental mite research has used either mean RH or absolute humidity as a proxy for the seriousness of the mite problem. Most field studies have tried to monitor either RH or absolute humidity and relate this to health symptoms or sampled mite densities. Some countries have even set mean RH or absolute humidity as a recommended value in order to control mite populations (Becher *et al* 1999; Platts-Mills and Weck 1987).

The first section of this paper demonstrates that although RH is key to determining the rate at which mites dehydrate, other factors such as temperature are also critical in determining population size. Therefore the mean RH may under some situations be a poor proxy for mite population or faeces production. One of the aims of this project is to test the validity of mean RH and if not appropriate develop new proxies. For example, it may be better to use a concept similar to the degree-day concept. Mites for which the CEH is 70% will dehydrate more quickly at 50% RH than at 60% RH. However, a period of RH at 80% may not offset a period at 60% RH. In other words, the population response to RH is highly non-linear. This could be taken into account by calculating the total number of RH-hours below CEH. RH-hours₇₀ is thus defined as the sum of CEH - RH for each hour of the year when RH is below 70%. RH-hours can then be normalised to obtain a number between 1 (ideal conditions for mite growth) and 0 (ideal conditions for eliminating mites). This takes account of the impact of RH, but not temperature. For temperatures below 25°C egg to adult time significantly lengthens (above this it appears to remain fairly constant). Therefore it may again be appropriate to sum the degree hours below 25°C and normalise this to obtain a number between 1 (ideal conditions for mite growth) and 0 (ideal conditions for eliminating mites). Multiplying these two sub-indices on an hourly basis and summing them may be a better proxy for dust mite populations than the mean RH alone. The resultant number can be calculated for each grid cell or spatial zone of the bed. If the Index for *all* zones is low, this clearly suggests a mite free bed. On the other hand, even a single zone with a low score suggests the likelihood of mite infestation and this likelihood will rise the higher the number of such zones and the lower their scores. Different ways of summarising the overall risk are being investigated.

It remains to be seen whether the Mite Index developed and refined along these lines will prove useful. Being based on simple physics, it has the virtue of transparency and can potentially be used to calculate the risk factor for a large number of combinations of climate zone, building characteristics and occupant behaviour. However, more sophisticated population models, which provide a full understanding of mite infestation, are required to test the validity of these simpler proxies.

The Cunningham model

A valuable step forward has recently been made by Cunningham (2000). Using the limited mite physiology data available, he has curve fitted two separate equations, one for population growth rate when RH is above CEH and the other for population decline when RH is below it. The effect of temperature is also included in the equations. For any time interval for which temperature and RH are known, the model can thus predict the effect on mite populations. In his paper Cunningham applies the model to monitored hourly data for temperature and RH at particular locations in bedding, carpets and upholstery, showing the predicted effect on mite population in each case. As better data becomes available, the curve fitting exercise would need to be repeated, but in principle a framework is put forward for simulating transient effects.

On the other hand the Cunningham model is not, as it stands, a multi-zonal model. It considers what is happening at any individual location for which there is RH and temperature data, but not how adjacent zones interact or how mites may move between zones, for example to escape hostile conditions. The model is thus unable to predict the aggregate mite population in, for example, a mattress as a whole (except by considering it as a single homogenous zone represented by one typical point). In view of the significant spatial variations reported above, this is a major limitation. The model also takes no account of population structure, which is likely to be relevant, since each stage in the mite's life cycle from egg to adult is affected differently by temperature and humidity. In other words, the process by which a population increases or declines is still incompletely represented.

The new population model

In order to test the validity of different proxies for population a detailed population model has been developed that:

- is multi-zonal. The study volume is divided into a 3-D grid of cells as chosen by the user. This grid can coincide with the grid of input hygrothermal data, but the model includes an algorithm for allocating values if the selected grid is different.
- takes account of mite movement in response to hygrothermal conditions, using the results of the mite box experiments previously described.
- considers the effect of hygrothermal conditions not simply on overall mite population, but on all stages of the mite's life cycle.

The data requirements for such a model are considerable. For all relevant combinations of temperature and humidity found in beds, we require values for each of the three main species for the following variables:

- Rates of egg production, ideally in relation to age of female
- Egg to larva and larva to adult development times
- Mortality rates for eggs, juveniles and adults (male and female)
- Mite movements, including between zones and immigration/emigration.

Unfortunately, despite the efforts of experimental acarologists, there are serious deficiencies in the data sets available. Nevertheless, there is enough data at least to make a start in developing the new model and establishing a framework. This will allow us to make explicit the types and form of data required so that research effort can be better directed. As will be reported more fully in a later paper, the incomplete matrices are being filled by making simplifying assumptions. These are then forming the basis for curve-fitting equations and the derivation of rate functions. As better data sets become available, it will be a comparatively simple matter to adjust the controlling parameters accordingly.

The model takes as inputs either the outputs of the hygrothermal model described above, that is to say the predicted hourly temperature and RH values for each point on a three dimensional grid of the bed environment, or real monitored values. An initial starting population of young adult mites is assumed, distributed as the user chooses. The model then calculates the effect of the hygrothermal conditions for each cell and time interval, for each life cycle stage. Thus new eggs are laid, previously laid eggs hatch, juveniles mature and adults age and die. An algorithm has also been developed whereby juveniles and adults travel to an adjacent zone if conditions are more favourable. The effect of immigration into and emigration out of the system is also included, as occurs for example when infested clothing is dropped onto the bed or when sheets are washed or the mattress is vacuumed.

Having run the model for a specified length of time, the output is the number of eggs, juveniles and adults in each cell at the end of the run. Although it would be possible to store these values for each time interval, this would significantly slow the model's operation and only the final result is stored. However, a user interface is already in place so that one can watch in both plan and section how these values change with each time step. In addition, the total mite population in the bedding is stored for each time step and is displayed as a histogram that builds up (or down) as the run progresses.

This population model is far more complex than predecessors are and matches the level of detail now possible with hygrothermal modelling. It therefore allows for a comprehensive examination of how mite population dynamics are affected by changing environmental conditions. For any given context, it will then be possible to determine how the latter can be manipulated in order to minimise mite infestation. It will also enable the testing of simpler proxies for population growth such as mean RH.

At this stage in its development, the combined hygrothermal/population model considers only the bed microenvironment, but it would not be difficult to extend it to include carpets, the next most important microenvironment. Future developments of the model will also include allergen production.

DISCUSSION

This paper covers work in progress to develop a combined detailed micro-environmental and population model. The house dust mite appears to be exquisitely sensitive to hygrothermal conditions in its microclimate, which in turn are the net result of many interacting variables, some of which are potentially controllable. The overall aim of this project is to contribute to unravelling this complex process and it is hoped that the model will be useful in obtaining a better understanding of the role that environmental controls in buildings can play in reducing house dust mite populations to acceptable levels.

Progress is being made in developing both the hygrothermal and the population sub-models and we are now in the process of linking them together. On the hygrothermal side, we have been able to adapt and build on existing modelling techniques and we are already achieving results of reasonable accuracy at a relatively fine level of spatial detail. Data for the hygroscopicity of various bedding materials is in short supply, but we hope to make good this deficiency in the near future. On the population modelling side, the lack of data is a more serious problem which will require extensive further experimental research on mite physiology to resolve. Better methods of sampling mite colonies in dwellings will also be required for validating the model predictions. Nonetheless, we have been able to develop a modelling framework which can be fine tuned and validated with increasing accuracy as more data become available. For the future, we also hope to extend the model to include allergen production, as well other mite microclimates such as carpets.

We envisage the model described in this paper as being essentially a research tool. However we are very much aware of the need for simpler models which are easier to use and have a wider applicability for building designers and engineers, local authorities, environmental health workers, manufacturers of building components, the building research community and medical researchers. It is anticipated that once the detailed model has been successfully developed, some of its complexity will be found to be unnecessary. By eliminating, or summarising this excess complexity, we thus hope to develop and test the validity of a simpler version that can be more effectively used by those involved in the design, construction, management and use of dwellings. Progress has already been made in the development of this simple model and the initial results will be published shortly.

REFERENCES

- Andrews, J., Cunningham, M. J., Pike, A., Wood, S. and Hearfield, M. (2000). House dust mite (*Dermatophagoides pteronyssinus*) mortality in occupied beds and in heated and unheated carpet. (abstract) Session 1, XXI International Congress of Entomology, 2000, Foz do Iguassu, Brazil.
- Arlian, L. G. (1992). Water balance and humidity requirements of house dust mites. *Experimental and Applied Ecology* **16** : 15-35.
- Arlian, L. G. and Veselica, M. (1981). Effect of temperature on the equilibrium body water mass in the mite *Dermatophagoides farinae*. *Physiological Zoology* **54** : 393-399.
- Arlian, L. G., Woodlford, P. J., Bernstein, I. L. and Gallagher, J. S. (1983). Seasonal population structure of house dust mite, *Dermatophagoides* spp. *Journal of Medical Entomology* **20** : 99-102.
- Arlian, L. G., Confer, P. D., Rapp, C. M., Vysenski-Moher, D. L. and Chang, J. C. S. (1998). Population dynamics of house dust mites *Dermatophagoides farinae*, *D. pteronyssinus* and *Euroglyphus maynei* (Acari: Pyroglyphidae) at specific relative humidities. *Journal of Medical Entomology* **35**(1) : 46-53.

- Asselt, L. Van. (1999). Interactions between domestic mites and fungi. *Indoor and Built Environment* **8** : 216-220.
- Becher, R. (1999). Revised guidelines for indoor air quality in Norway. Proceedings of Indoor Air '99, Vol 1, 171-176.
- Bronswijk, J. E. M. H. van (1981). *House Dust Biology for Allergists, Acarologists and Mycologists*. NIB Publishers, The Netherlands.
- Charpin, D., Kleisbauer, J., Lanteaume, A., Razzouk, H., Vervloet, D., Toumi, M., Faraj, F. and Charpin, J. (1988). Asthma and allergy to house-dust mites in populations living in high altitudes. *Chest* **93(4)** : 758-761.
- Colloff, M.J. (1987). Mites from house dust in Glasgow. *Medical and Veterinary Entomology* **1**: 163-168.
- Colloff, M. J. (1998). Distribution and abundance of dust mites within homes. *Allergy* **53** Supplement 48 : 24-27.
- Colloff, M. J. (1991). Practical and theoretical aspects of the ecology of house dust mites (Acari: Pyroglyphidae) in relation to the study of mite-mediated allergy. *Review of Medical and Veterinary Entomology* **79** : 611-630.
- Cunningham, M. J. (1998). Direct measurements of temperature and humidity in dust mite microhabitats. *Clinical and Experimental Allergy* **28** : 1104-1112.
- Cunningham, M. J. (2000). A proposed experimental programme towards control of dust mites by microclimate modification. In R. Siebers, M. J. Cunningham, P. Fitzharris and J. Crane (eds.) *Mites, Asthma and Domestic Design III*. The Print Shpppe, Wellington. pp. 69-78.
- De Boer, R. (1990). Effect of heat treatment on the house dust mite *Dermatophagoides pteronyssinus* ad *D. farinae* (Acari: Pyroglyphidae) in a mattress-like polyurethane foam block. *Exp. and Applied Acarology* **9**: 131-136.
- de Boer, R. (1998). Reflections on the control of mites and mite allergens. *Allergy* **53** : 41-46.
- de Boer, R., Kuller, K. and Kahl, O. (1998). Water balance of *Dermatophagoides pteronyssinus* (Acari: Pyroglyphidae) maintained at brief daily spells of elevated air humidity. *Journal of Medical Entomology* **35** : 905-910.
- de Boer, R. (1999). Het effect van vloerverwarming op de vorming van huisstofmijt-allergenen. NOVEM project number 221328/3210. Unpublished.
- Harving, H. Hansen, L. G., Korsgaard, J., Nielsen, P. A., Olsen, O. F., Romer, J., Svendsen, U. G. and Osterballe, O. (1991). House dust mite allergy and anti-mite measures in the indoor environment. *Allergy* **46** Supplement 11 : 33-38
- IEA (1994). Energy Conservation in Buildings and Community Systems, Annex 21, Subtask C, Empirical Validation of Thermal Building Simulation Programs using test room data, International Energy Agency 1994.
- ISAAC (1998). Worldwide variations in the prevalence of asthma symptoms: the International Study of Asthma and Allergies in Childhood (ISAAC). *Eur Respir J* **12** : 315-335.
- Korsgaard, J. (1998). House-dust mites and asthma. A review on house-dust mites as a domestic risk factor for mite asthma. *Allergy* **53** Supplement 48 : 77-83.
- Lau, S., Falkenhorst, G., Weber, A., Werthmann, I., Lind, P., Buettner-Goetz, P and Wahn, U. (1989). High mite-allergen exposure increases the risk of sensitisation in atopic children and young adults. *The Journal of Allergy and Clinical Immunology* **84**: 718-725.
- Mahmic, A., Tovey, E. R., Molloy, C. A. and Young, L. (1998). House dust mite allergen exposure in infancy. *Clinical and Experimental Allergy* **28** : 1487-1492
- Mendes, N., Ridley, I., Lamberts, R., Budag, K., Phillpi. (1999). Umidus: A PC software for modelling coupled heat and mass transfer. Proceedings, Building Simulation, Tokyo 1999.
- Niven, R. McL., Fletcher, A. M., Pickering, A. C., Custovic, A., Sivour, J. B., Preece, A. R., Oldham, L. A. and Francis, H. C. (1999). Attempting to control mite allergens with mechanical ventilation and dehumidification in British houses. *Journal of Allergy and Clinical Immunology* **103** : 756-762.
- Oreszczyn, T. and Pretlove, S. E. C. (1999). Condensation Targeter II: Modelling surface relative humidity to predict mould growth in dwellings. *Building Services Engineering Research and Technology* **20(3)** : 143-153.
- Platts-Mills, T. A. E. and Chapman, M. D. (1987). Dust mites: Immunology, allergenic disease and environmental control. *The Journal of Allergy and Clinical Immunology* **80** : 755-775
- Platts-Mills, T. A. E. and Weck, A. L. de. (1987). *Dust Mite Allergens and Asthma: A World Wide Problem*. Report of an International Workshop, Bad Kreuznach, F. R. G.
- Strien, R. T., Verhoeff, A. P., Brunekreef, B., van Wijnen, J. H. (1994). Mite antigen in house dust: relationship with different housing characteristics in the Netherlands. *Clin. Exp. Allergy*. **24**: 843-853.
- Wharton, G. W., Duke, K. M. and Epstein, H. M. (1979). Water and the physiology of house dust mites. In J. G. Rodrigues (Ed) *Recent advances in Acarology*, Volume 1. Academic Press, London.

Acknowledgements

This research project has been funded by the Engineering and Physical Sciences Research Council (EPSRC) of the UK.

Geographical Location	D. pteronyssinus	D. farinae	E. maynei
UK	1	3	2
Europe and Australasia	1	2	3
North America	2	1	3

Table 1 - Order of abundance of the three common house dust mite species

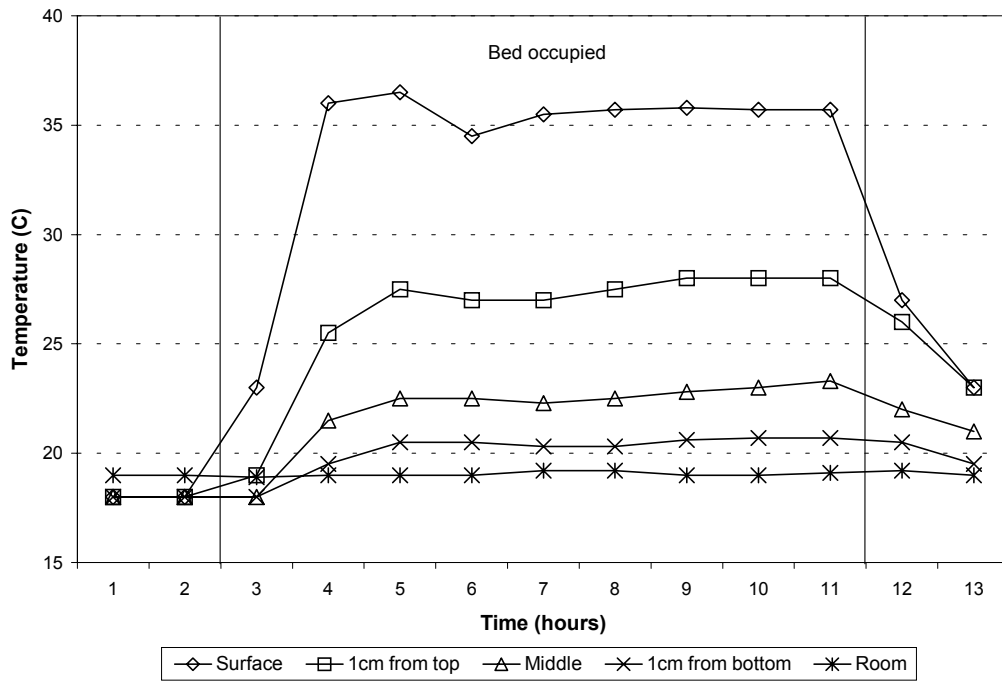

Figure 1 - Monitored temperature on the surface and within the mattress

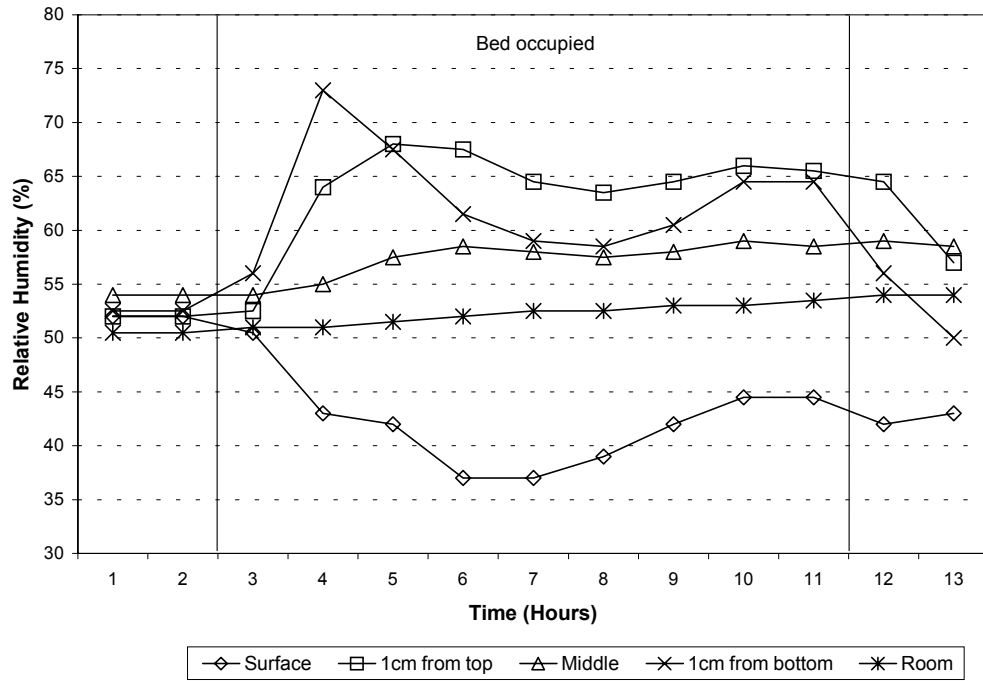

Figure 2 - Monitored relative humidity on the surface and within the mattress

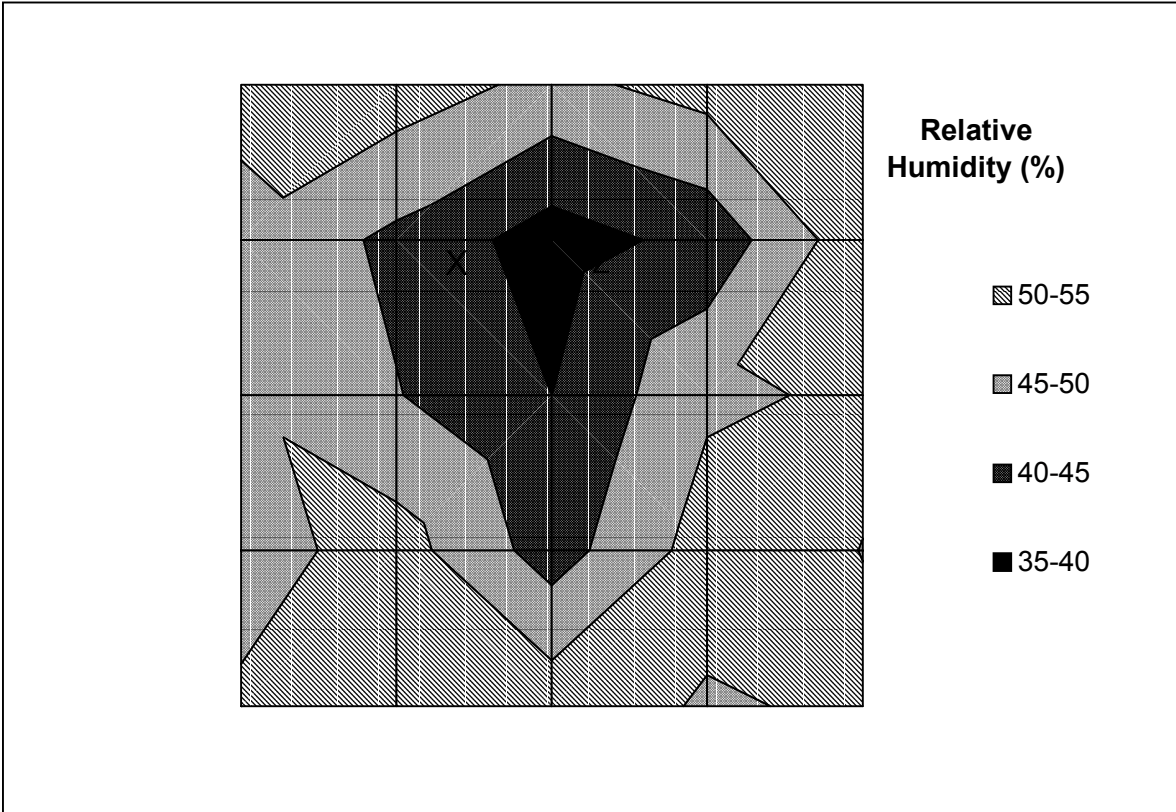

Figure 3 - Monitored relative humidity on the surface of the mattress at 4.00am

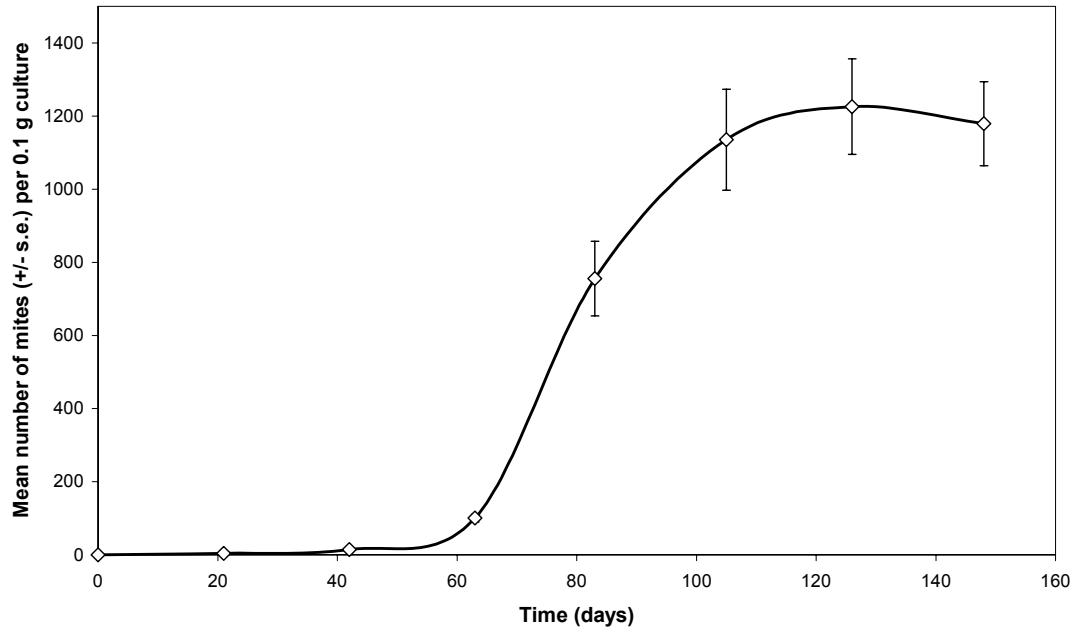

Figure 4 - Change in the mean number of mites over time

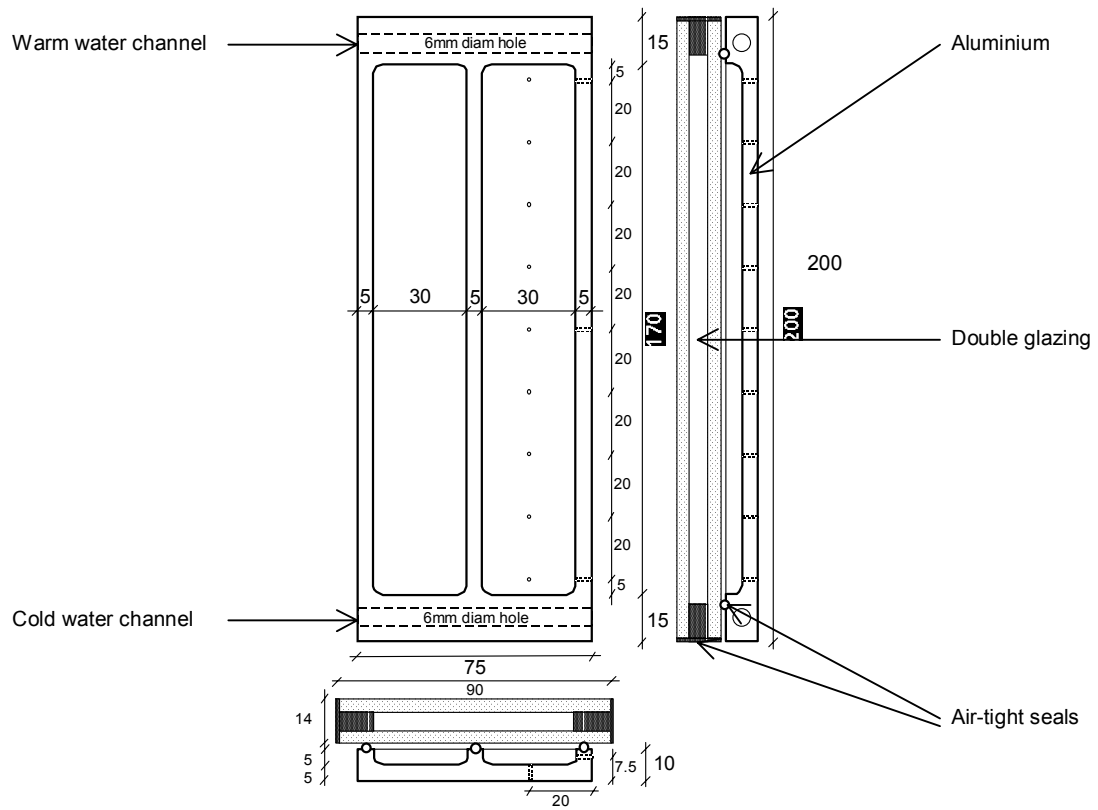

Figure 5 - Schematic diagram of mite chamber (the small holes are for instrumentation)

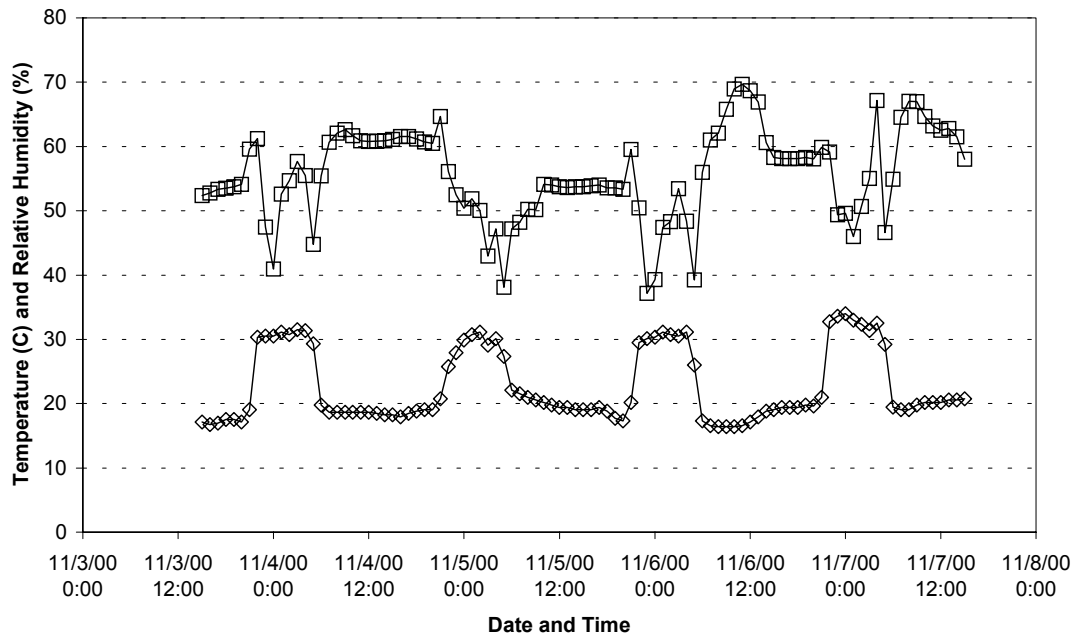

Figure 6 - Temperature and relative humidity measured in a typical bed during a four day period in November 2000

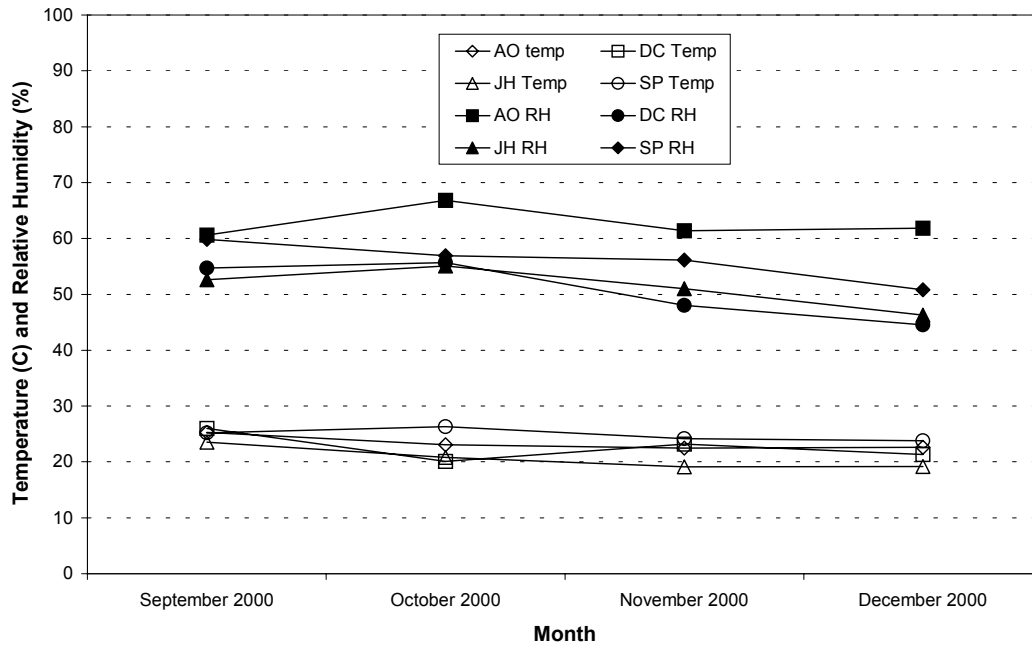

Figure 7 - Average conditions of temperature and relative humidity in participant's bedrooms

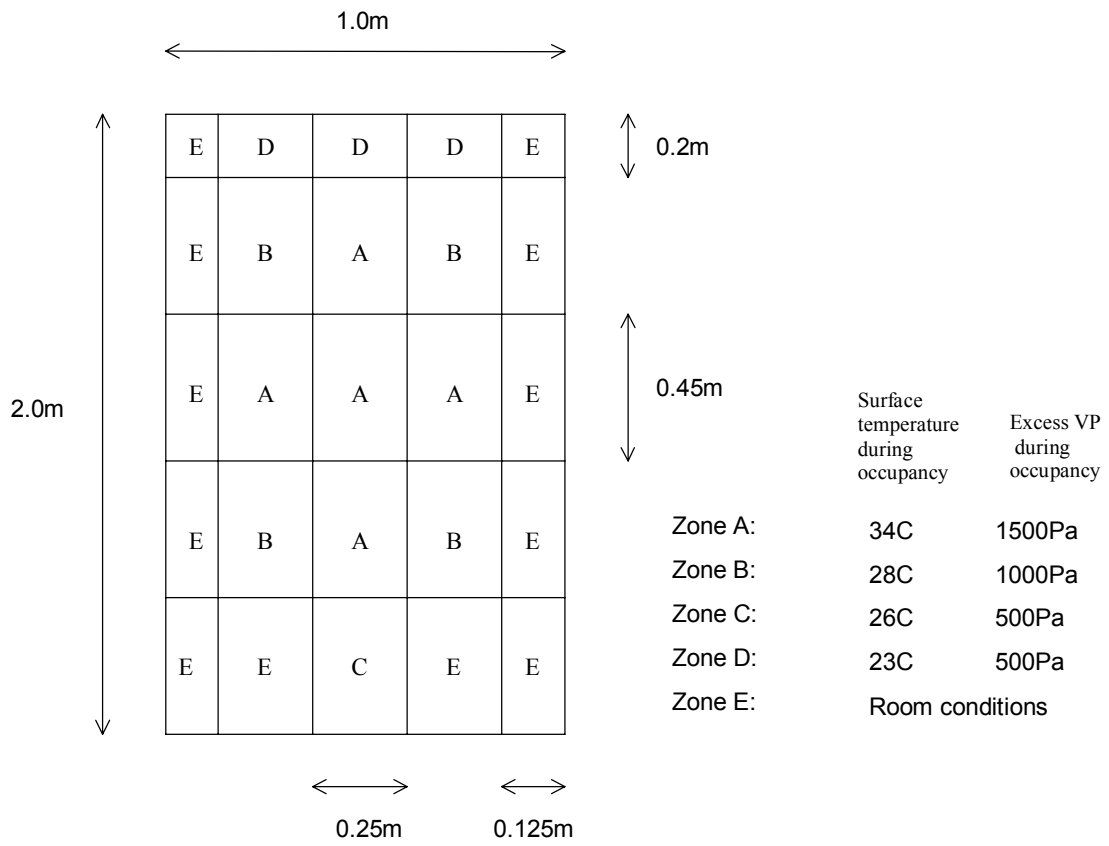

Figure 8 - Plan of bed showing boundary condition assumptions made by PreUmidus

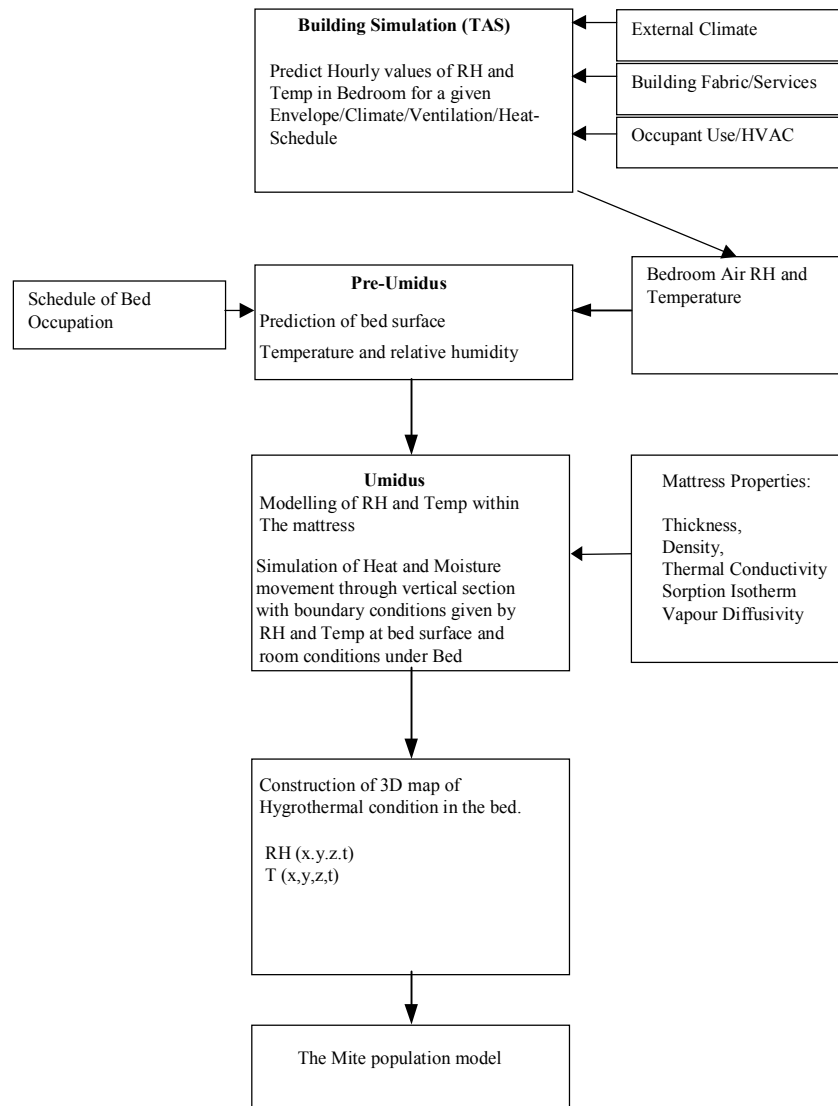

Figure 9 - Structure of the TAS/Umidus transient hygrothermal model

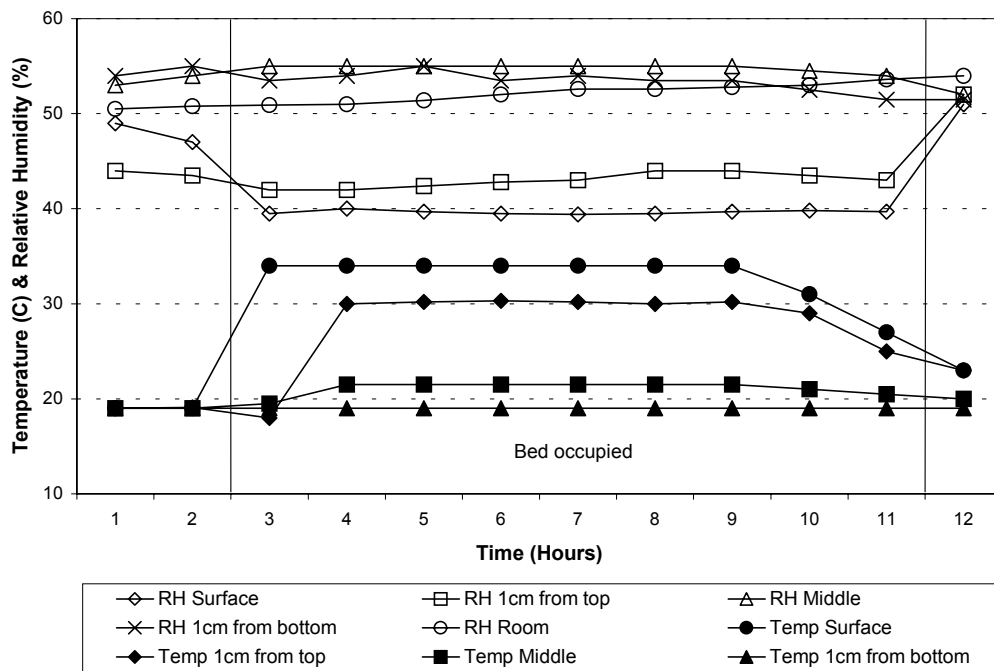

Figure 10 - TAS/Umidus simulated conditions within a mattress

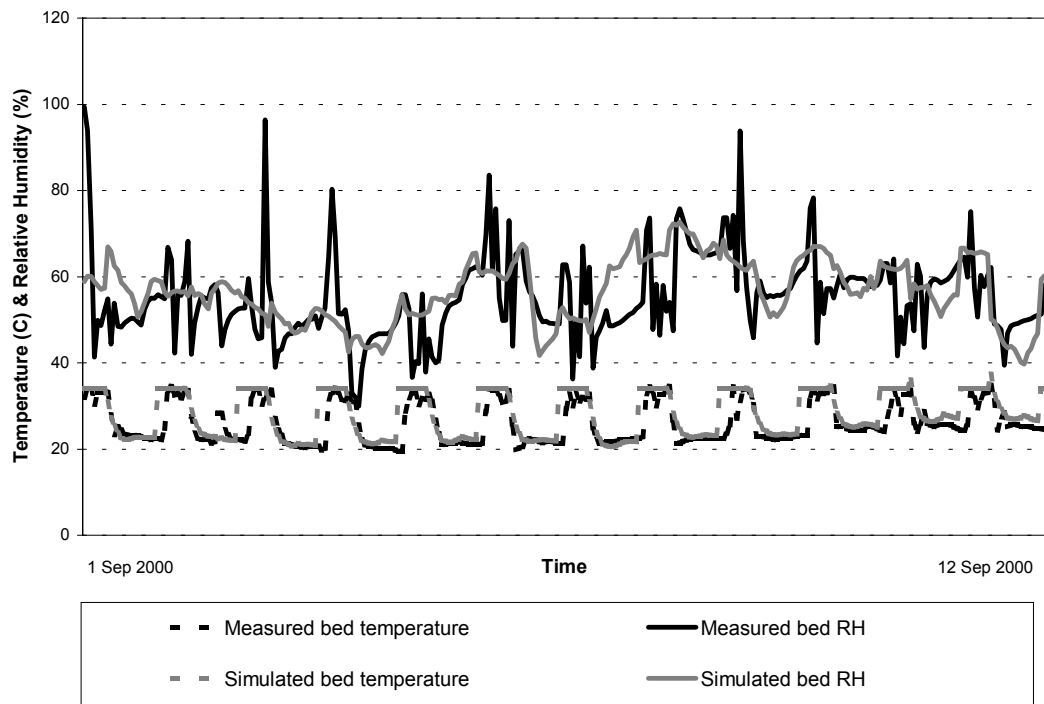

Figure 11 - Comparison of TAS/Umidus simulation and monitored bed conditions in unheated dwelling 1st to 12th September 2000

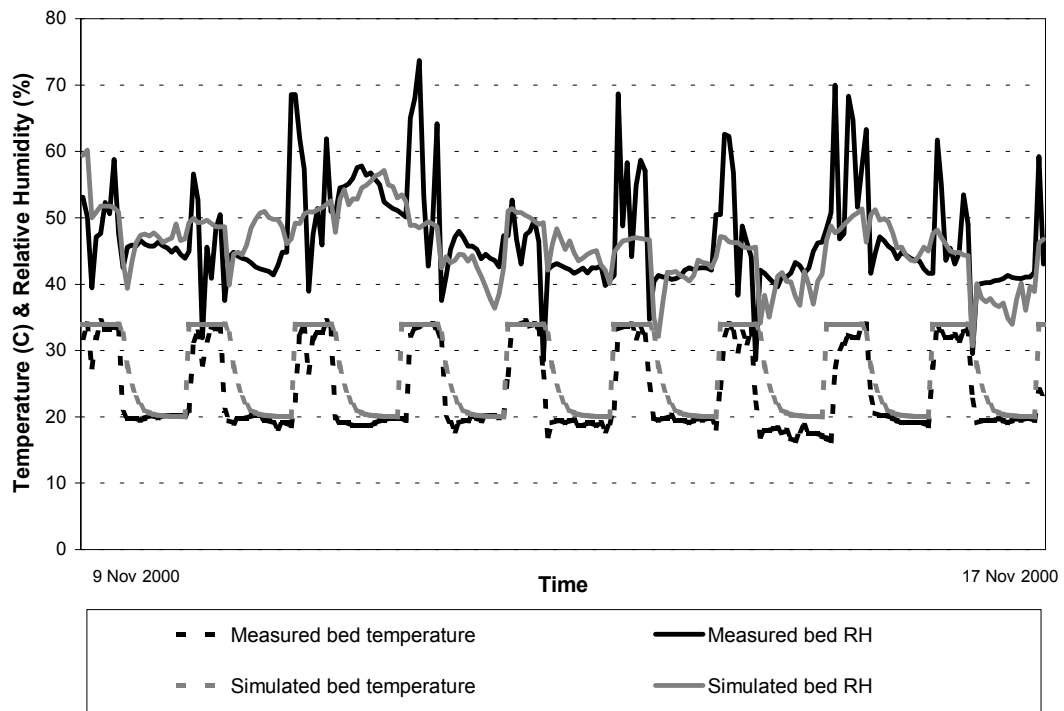

Figure 12 - Comparison of TAS/Umidus simulation and monitored bed conditions in heated dwelling 9th to 17th November 2000