



The IeMRC Opto-PCB Flagship Project

David R. Selviah

Department of Electronic and Electrical Engineering,

University College London, UCL, UK,

d.selviah@ee.ucl.ac.uk,

Dave Milward

Xyratex Technology Ltd.

Havant, UK

Dave_Milward@xyratex.com

Outline

- Electronic versus Optical interconnects
- The OPCB project
- OPCB University Research Overview
 - Heriot Watt
 - Loughborough
 - UCL
- System Demonstrator

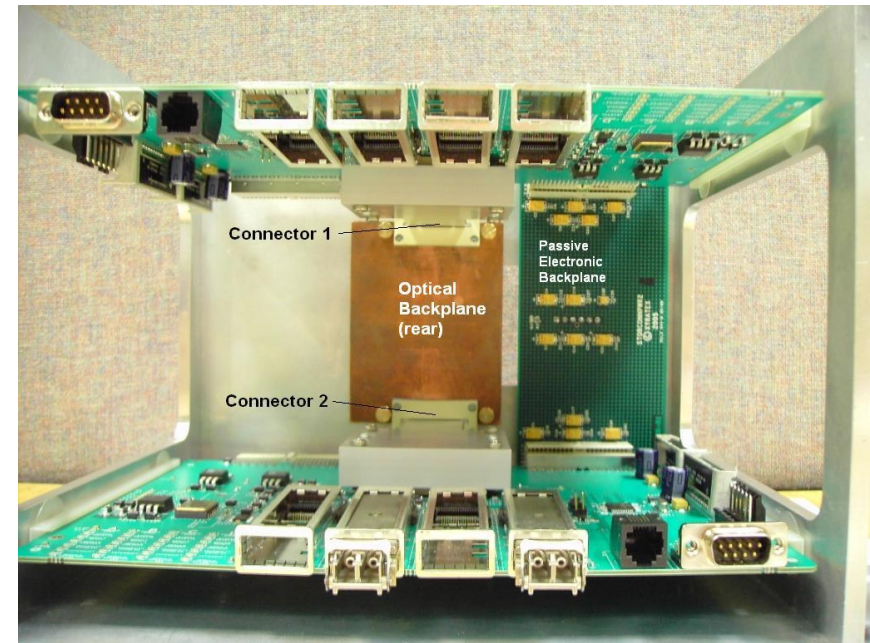
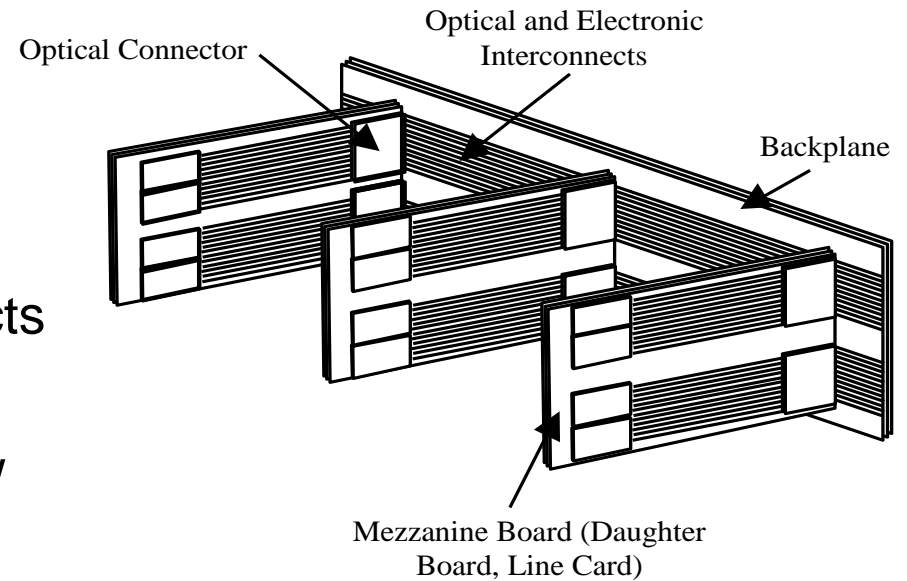

Copper Tracks versus Optical Waveguides for High Bit Rate Interconnects

- Copper Track
 - EMI Crosstalk
 - Loss
 - Impedance control to minimize back reflections, additional equalisation, costly board material

- Optical Waveguides
 - Low loss
 - Low cost
 - Low power consumption
 - Low crosstalk
 - Low clock skew
 - WDM gives higher aggregate bit rate
 - Cannot transmit electrical power

On-board Platform Applications

BAE SYSTEMS



On-board Platform Applications

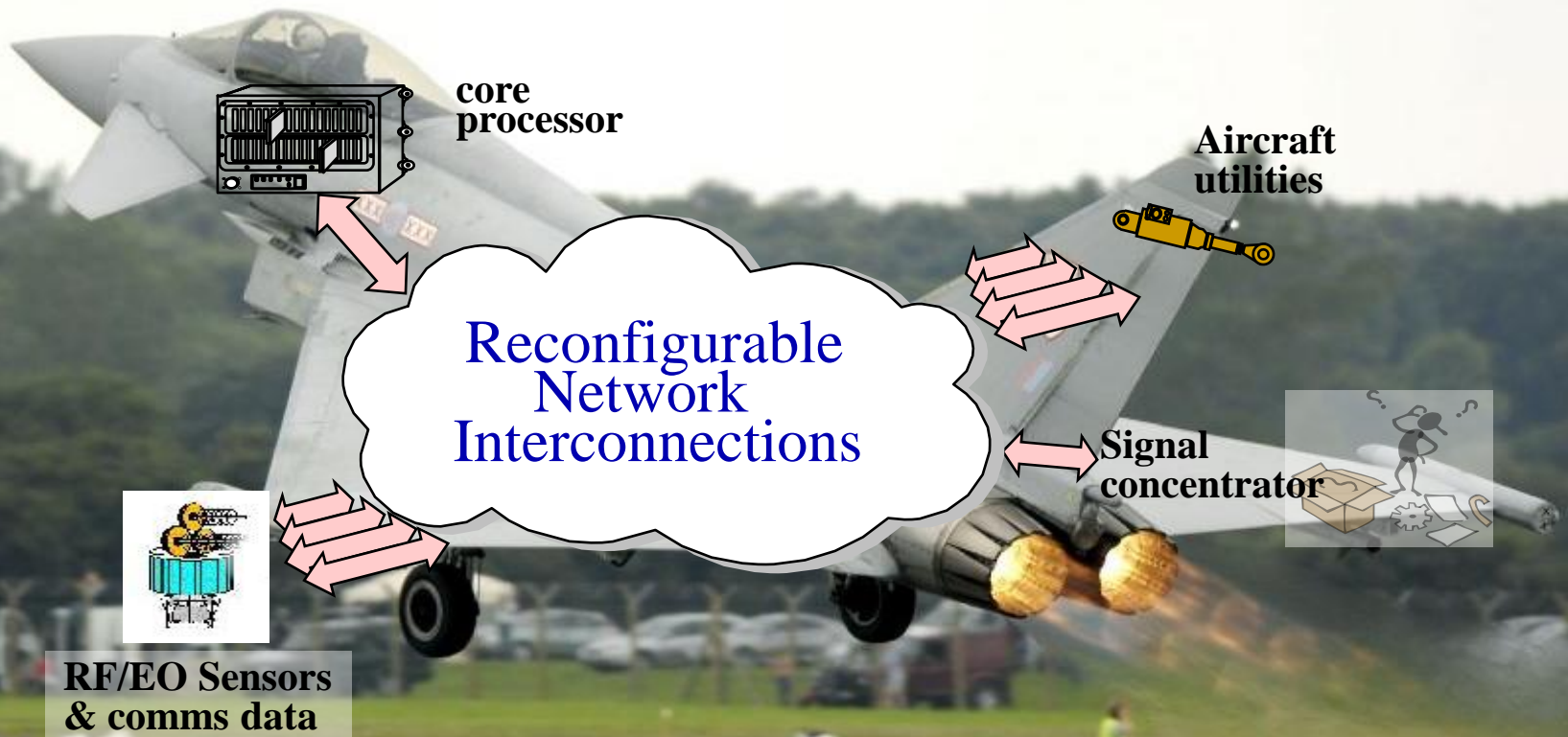

High Bandwidth Signals

The Integrated Optical and Electronic Interconnect PCB Manufacturing (OPCB) project

- Hybrid Optical and Electronic PCB Manufacturing Techniques
- 8 Industrial and 3 University Partners led by industry end user
- Multimode waveguides at 10 Gb/s on a 19 inch PCB
- Project funded by UK Engineering and Physical Sciences Research Council (EPSRC) via the Innovative Electronics Manufacturing Research Centre (IeMRC) as a Flagship Project
- 2 years into the 3 year, £1.3 million project

Integration of Optics and Electronics

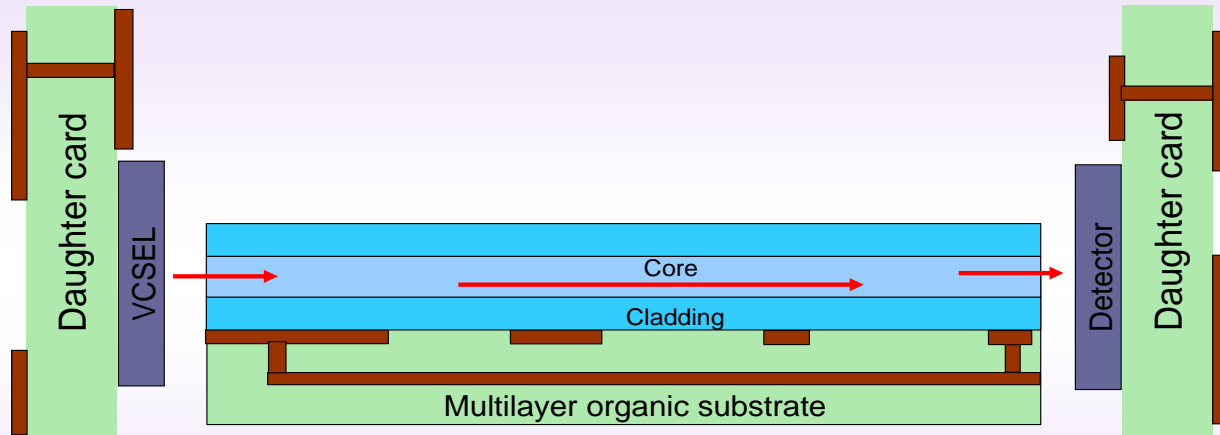

- Backplanes
 - Butt connection of “plug-in” daughter cards
 - In-plane interconnection
- Focus of OPCB project

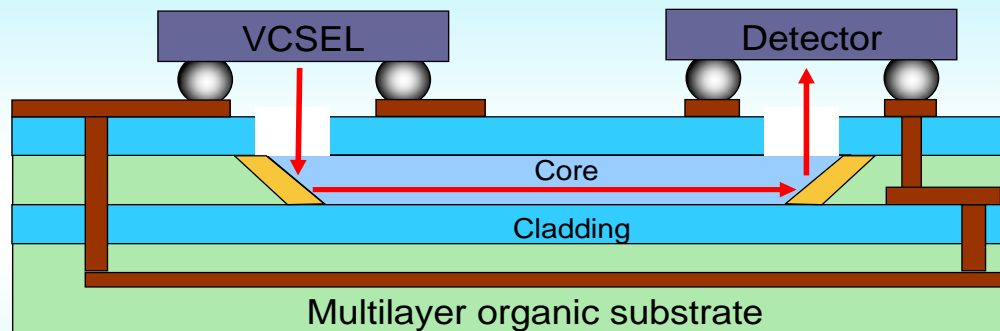

- Out-of-plane connection
 - 45 mirrors
 - Chip to chip connection possible

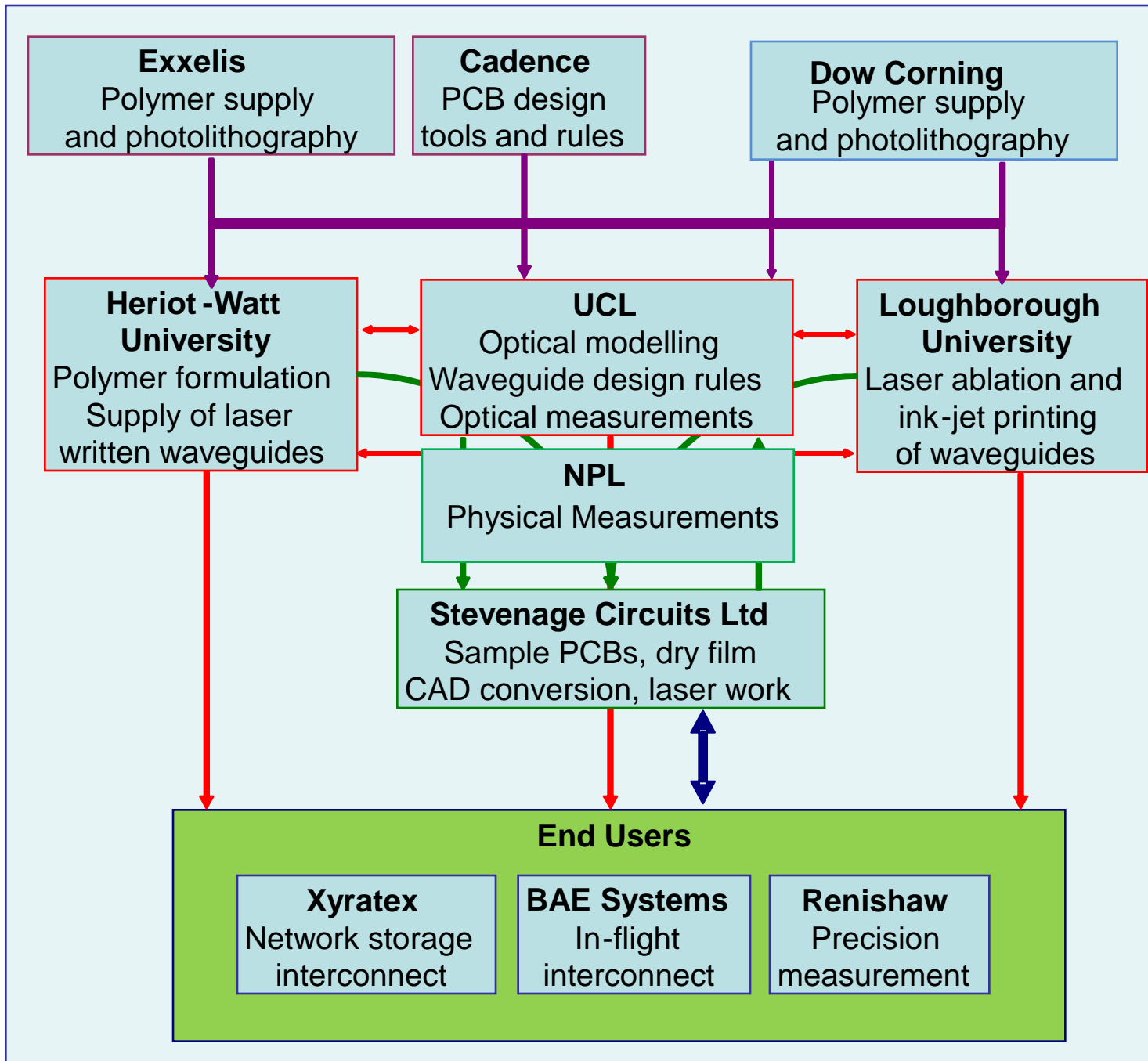

Direct Laser-writing Setup: Schematic

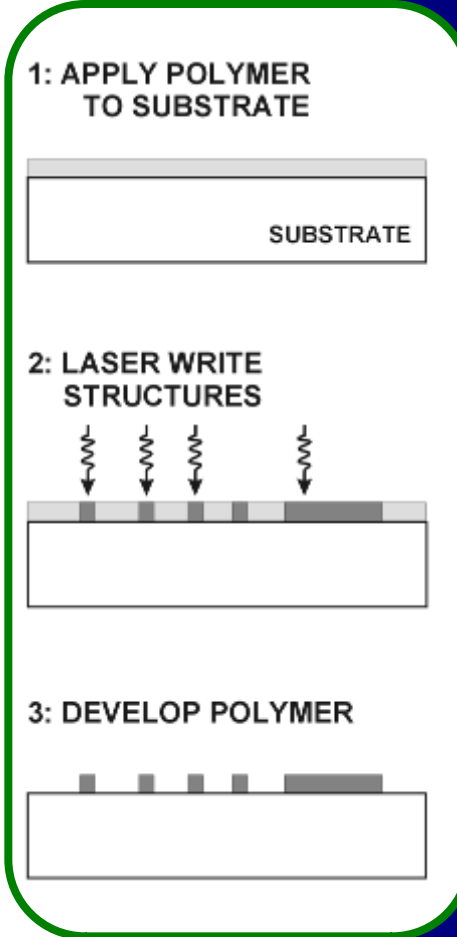
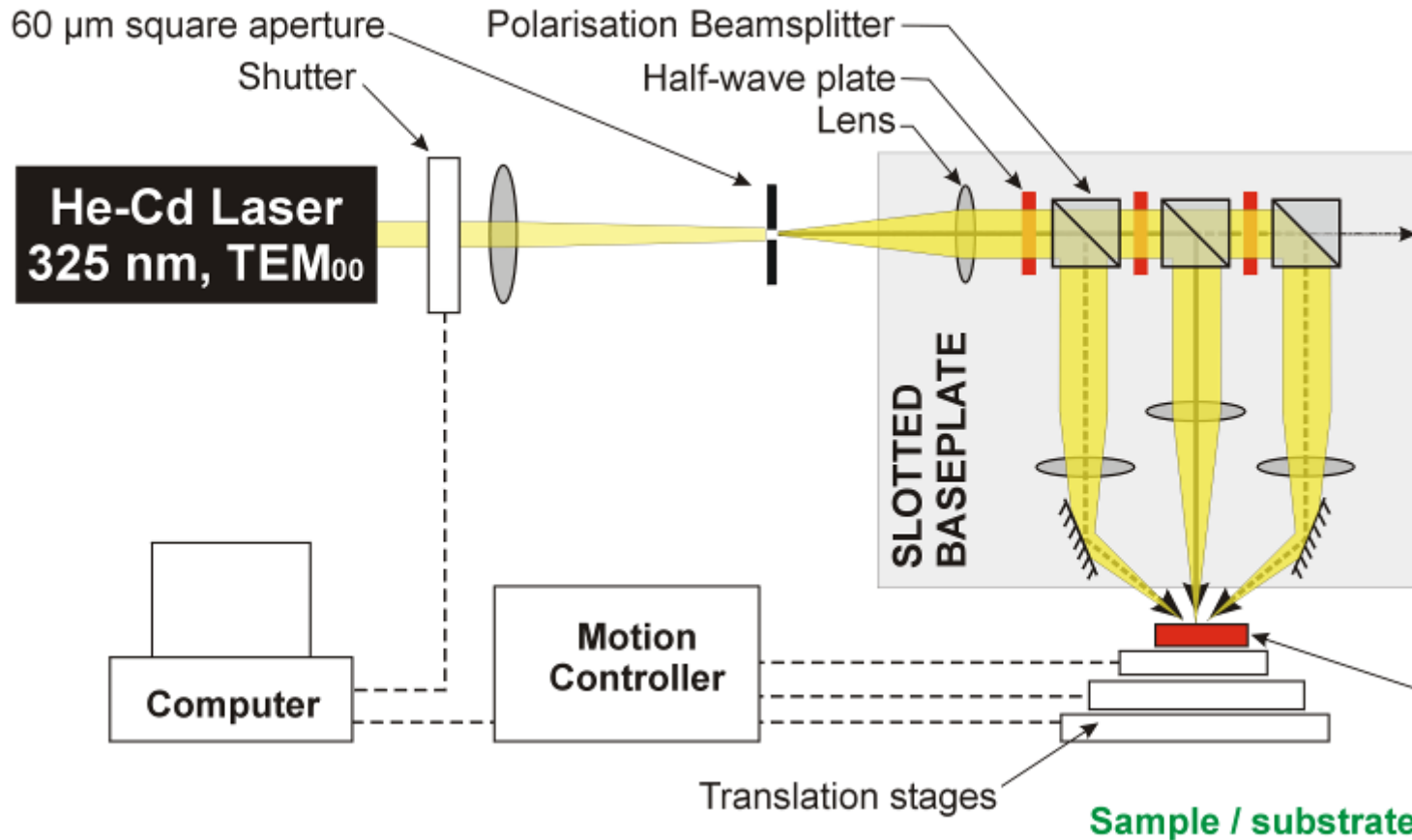

- **Slotted baseplate** mounted vertically over translation, rotation & vertical stages; components held in place with magnets
- By using two opposing 45° beams we minimise the amount of substrate rotation needed

Writing sharply defined features

– flat-top, rectangular laser spot

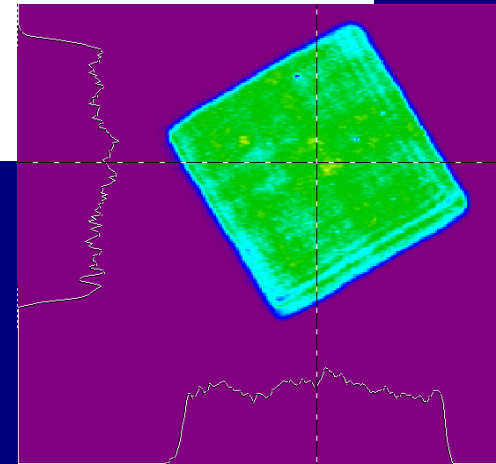
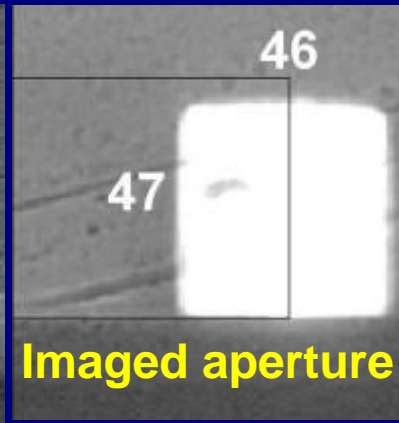
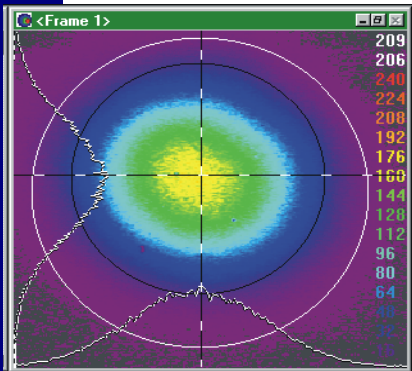
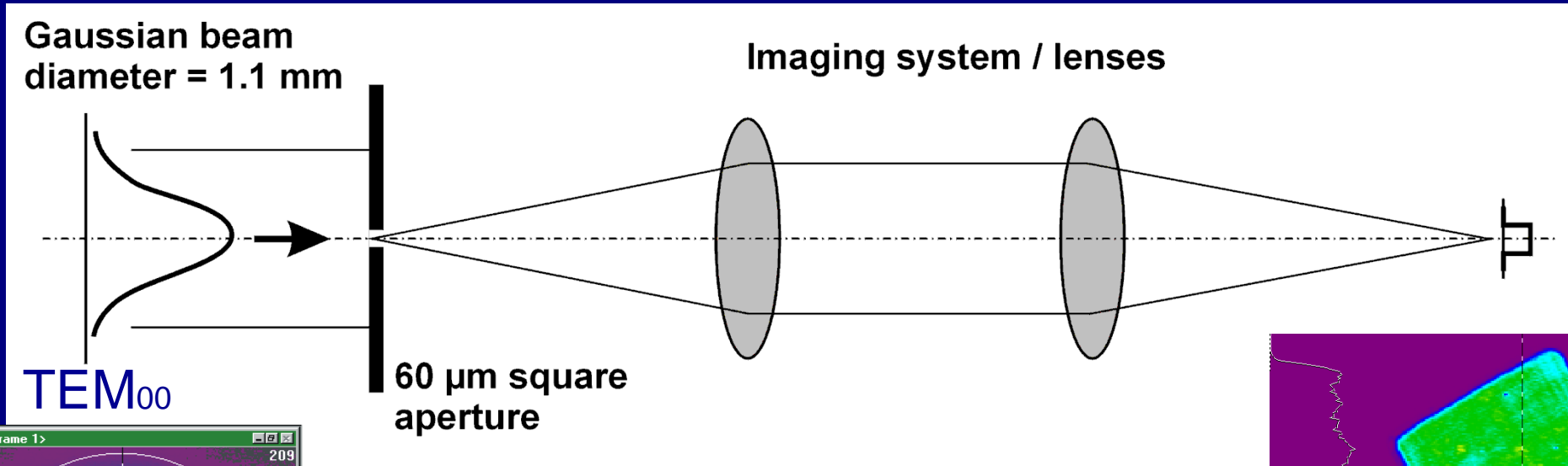

Images of the resulting waveguide core cross-sections

Laser written polymer structures

SEM images of polymer structures written using imaged 50 μm square aperture (chrome on glass)

- Writing speed: $\sim 75 \mu\text{m} / \text{s}$
- Optical power: $\sim 100 \mu\text{W}$
- Flat-top intensity profile
- Oil immersion
- Single pass

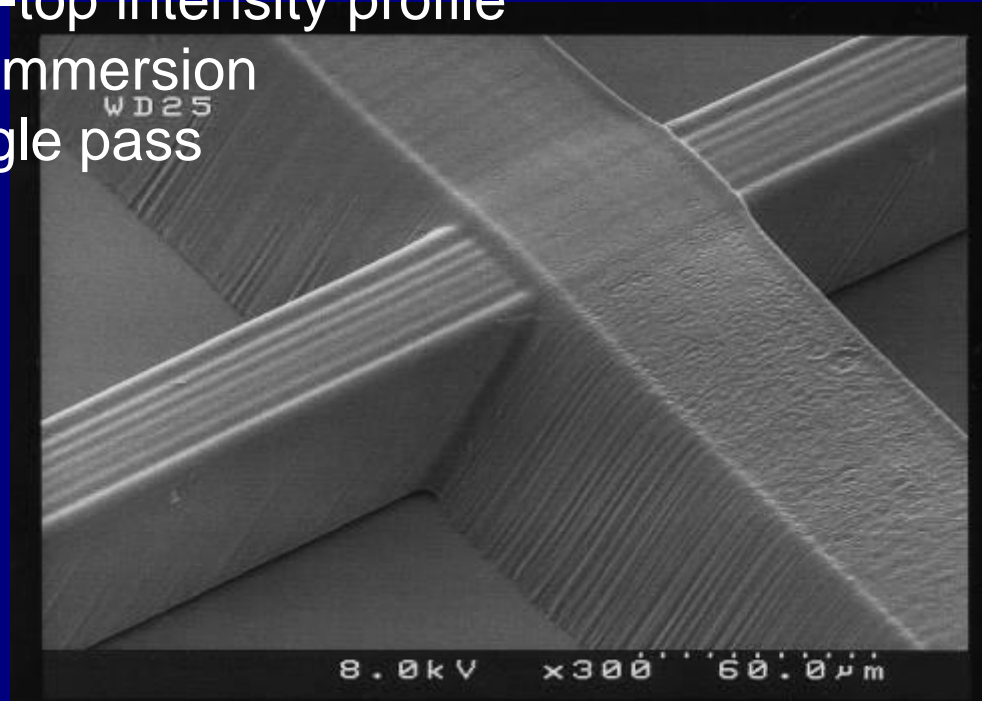
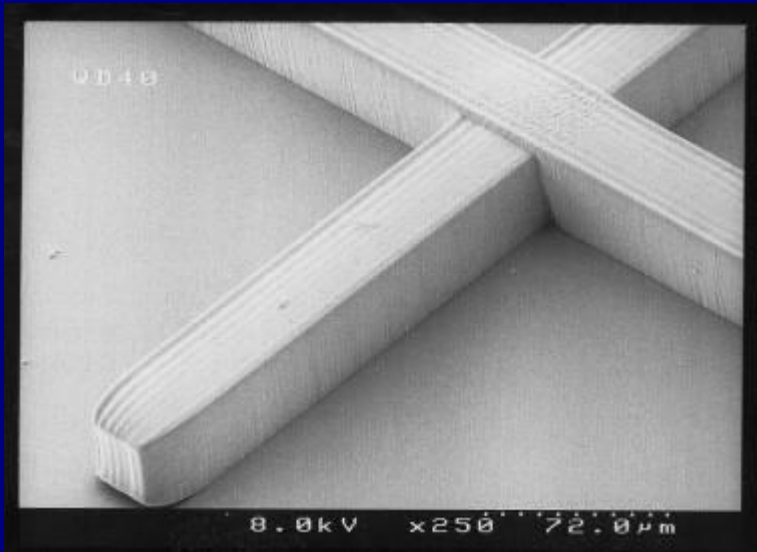

Optical microscope image showing end on view of the 45 $^\circ$ surfaces

Waveguide terminated with 45-deg mirror

Out-of-plane coupling,
using 45-deg mirror (silver)

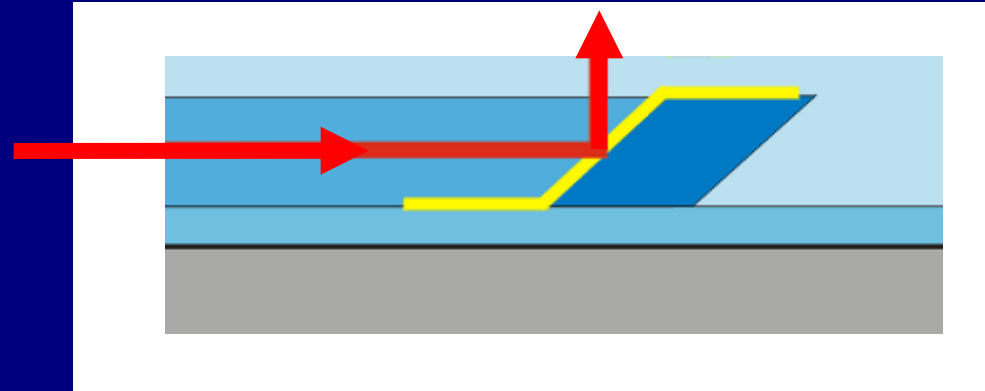

Microscope image looking
down on mirror
coupling light towards camera

OPTICAL INPUT

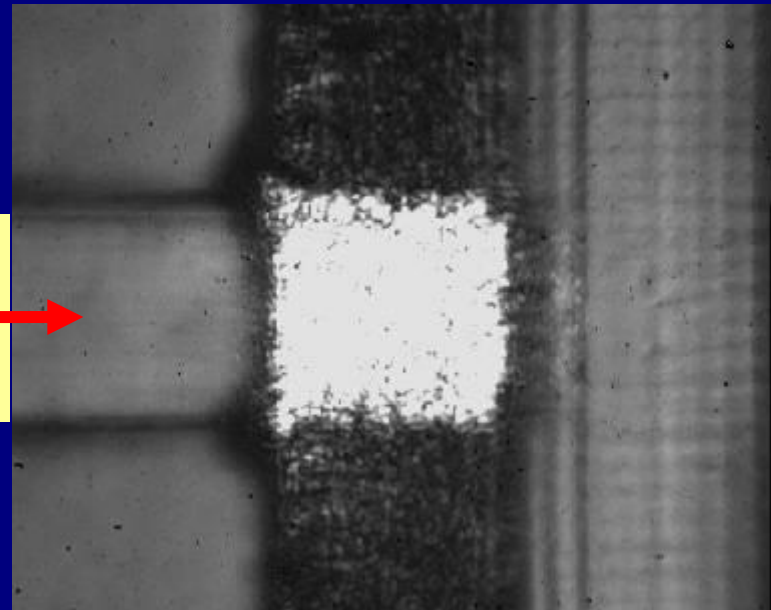

Current Results

Laser-writing Parameters:

- Intensity profile: Gaussian
- Optical power: ~8 mW
- Cores written in oil

Polymer:

- Custom multifunctional acrylate photo-polymer
- Fastest “effective” writing speed to date: 50 mm/s

(Substrate: FR4 with polymer undercladding)

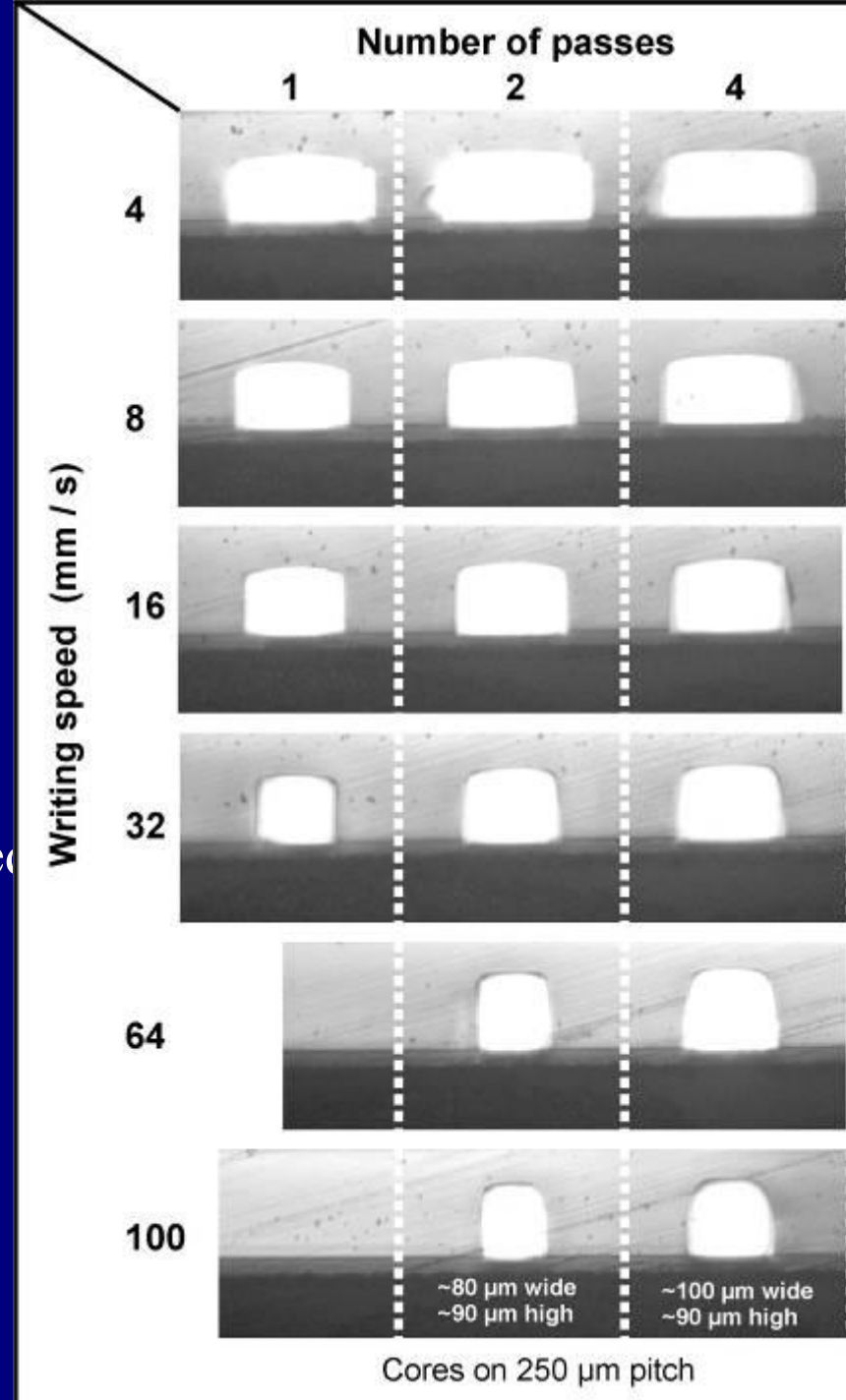

Large Board Processing: Writing

- Stationary “writing head” with board moved using Aerotech sub- μm precision stages
- Waveguide trajectories produced using CAD program

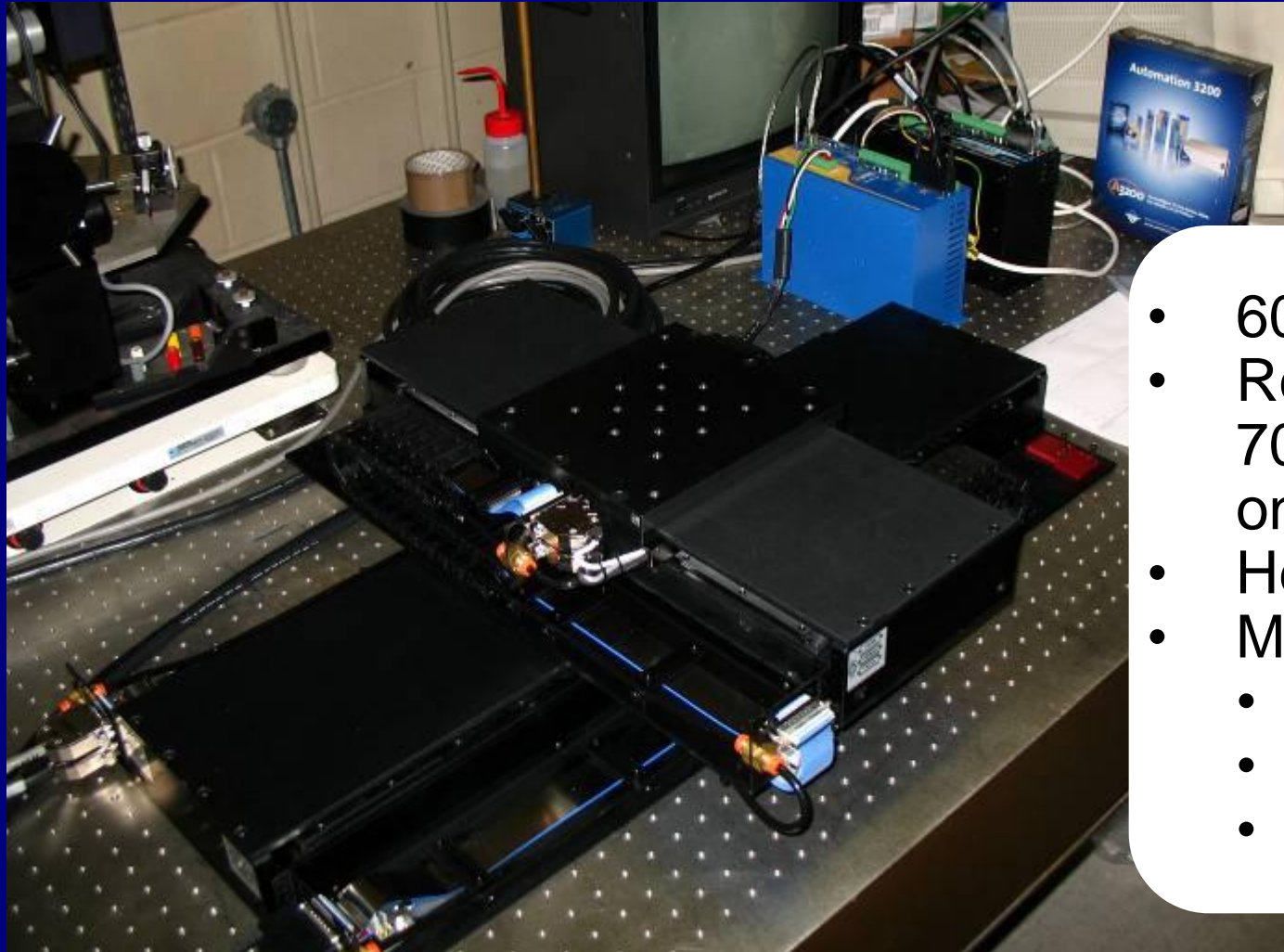

- 600 x 300 mm travel
- Requires a minimum of 700 x 1000 mm space on optical bench
- Height: ~250 mm
- Mass:
 - 300 mm: 21 kg
 - 600 mm: 33 kg
 - Vacuum tabletop

Large Board Processing: Writing

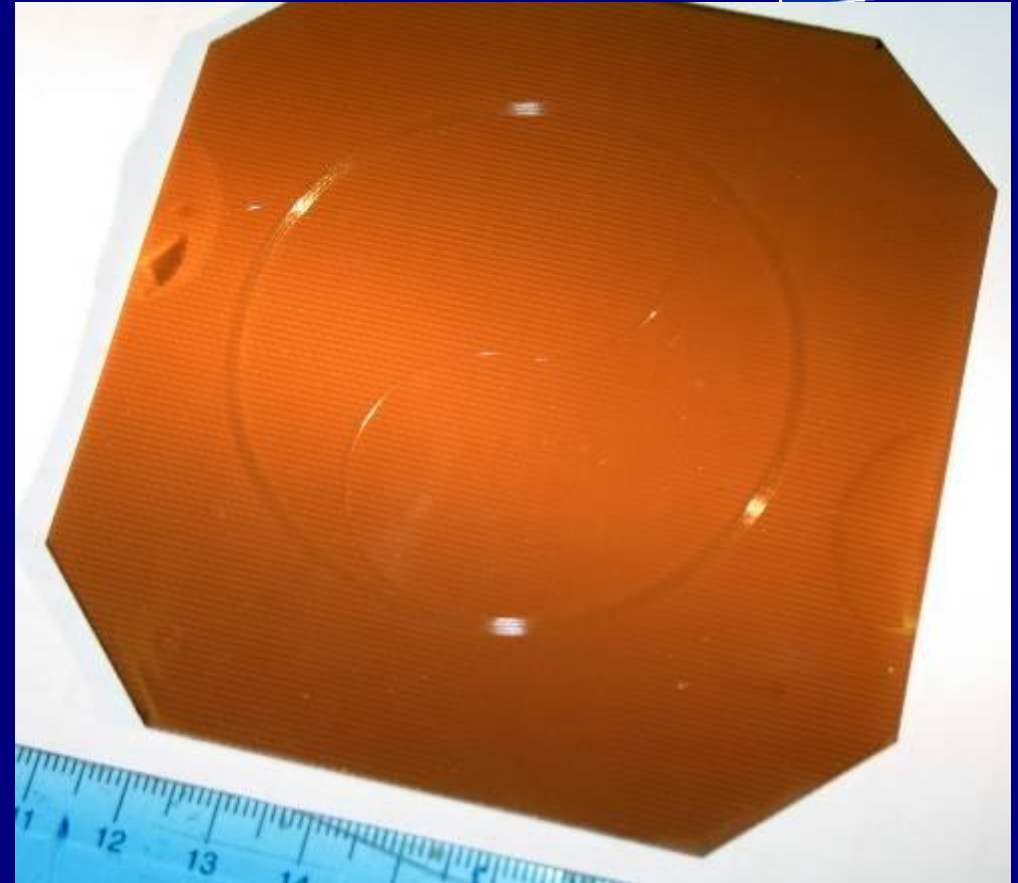
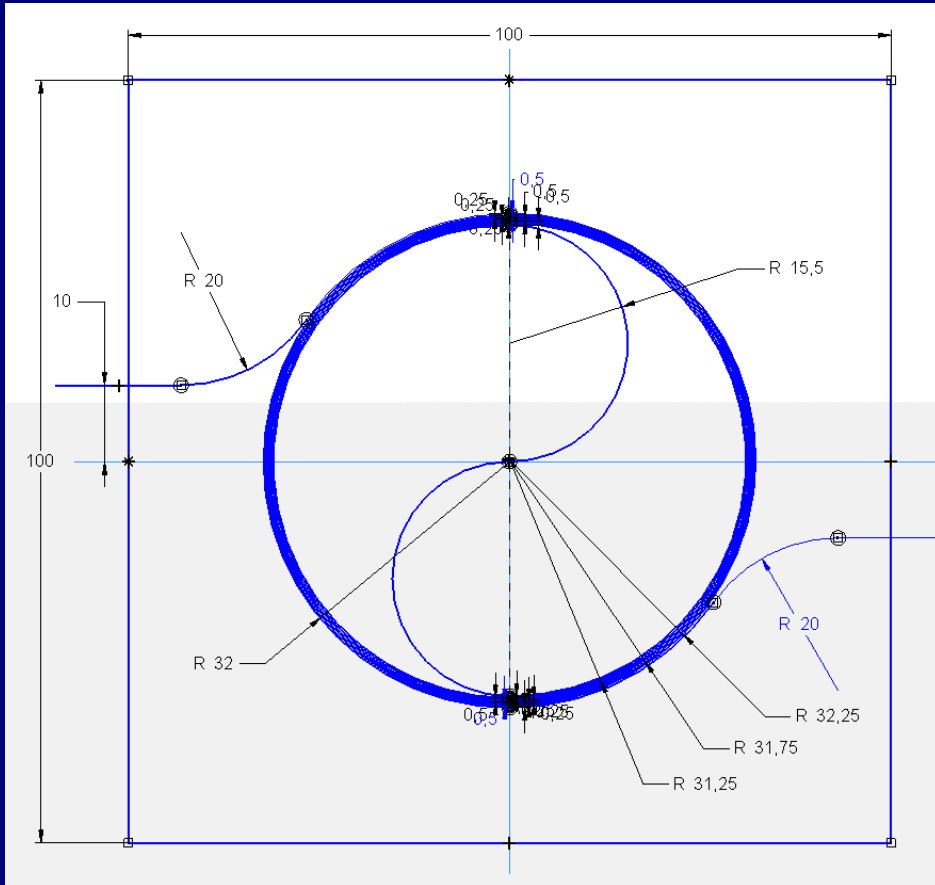

The spiral was fabricated using a Gaussian intensity profile at a writing speed of 2.5 mm/s on a 10 x 10 cm lower clad FR4 substrate. Total length of spiral waveguide is ~1.4 m. The spiral was upper cladded at both ends for cutting.

Laser Ablation for Waveguide Fabrication

- Ablation to leave waveguides
- Excimer laser – Loughborough
- Nd:YAG – Stevenage Circuits

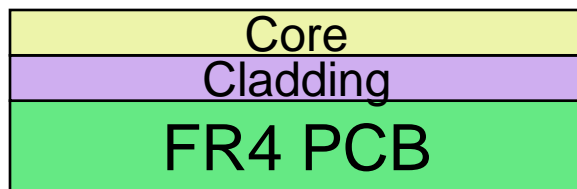

Deposit cladding and core layers on substrate

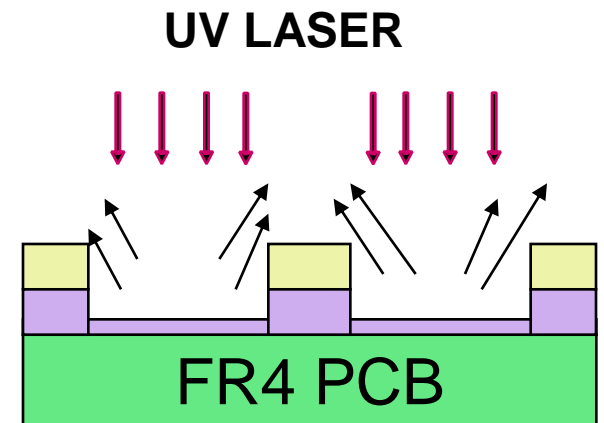

Laser ablate polymer

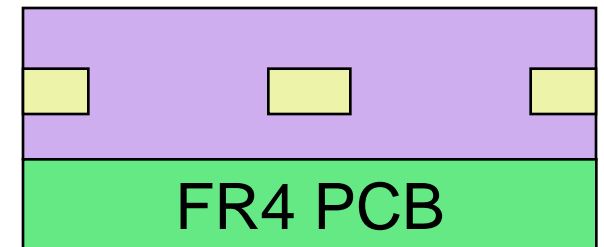

Deposit cladding layer

SIDE VIEW

Nd:YAG Ablation

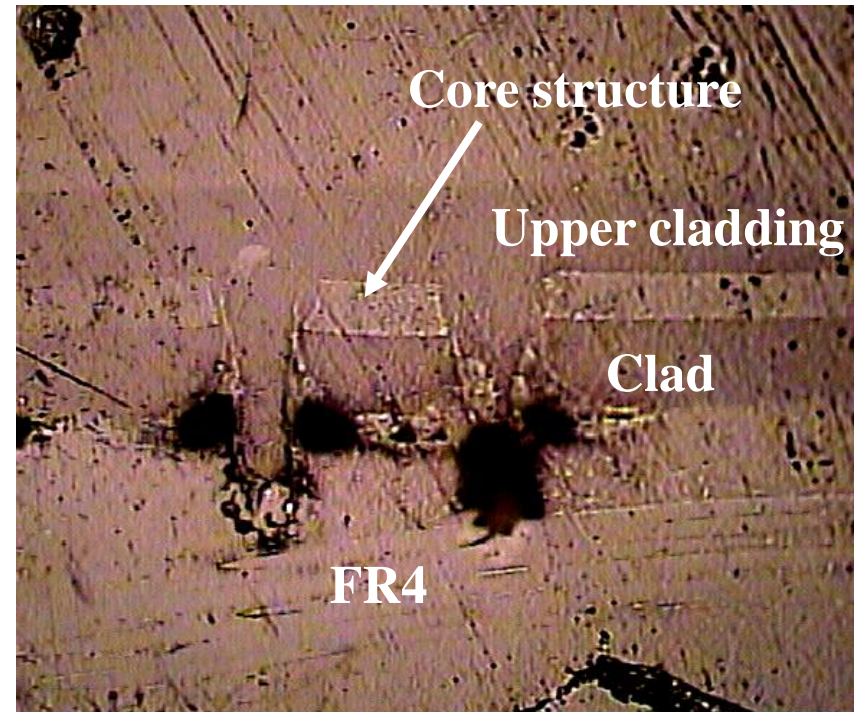
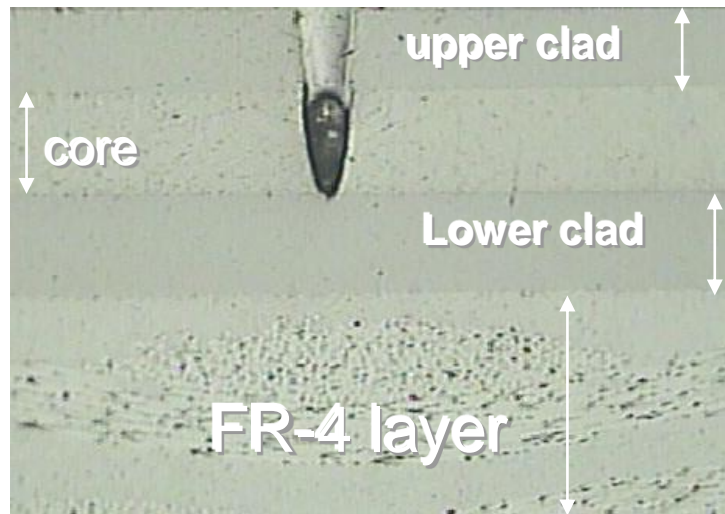

- Nd:YAG laser based at Stevenage Circuits
- Grooves machined in optical polymer and ablation depth characterised for machining parameters
- Initial waveguide structures prepared

Excimer Laser Ablation

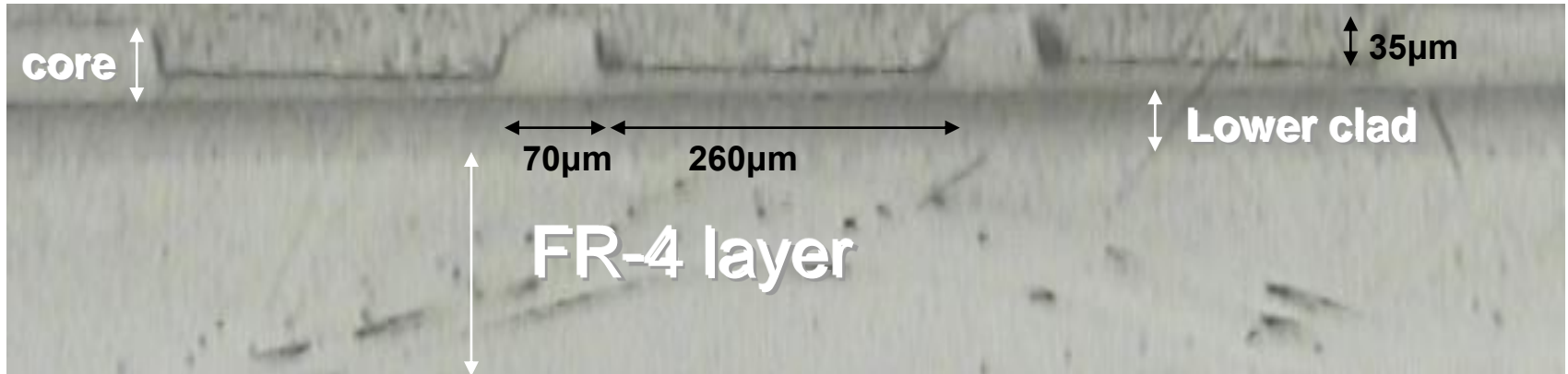

Cross-section

- Straight structures machined in polymer
- Future work to investigate preparation of curved mirrors for out of plane interconnection

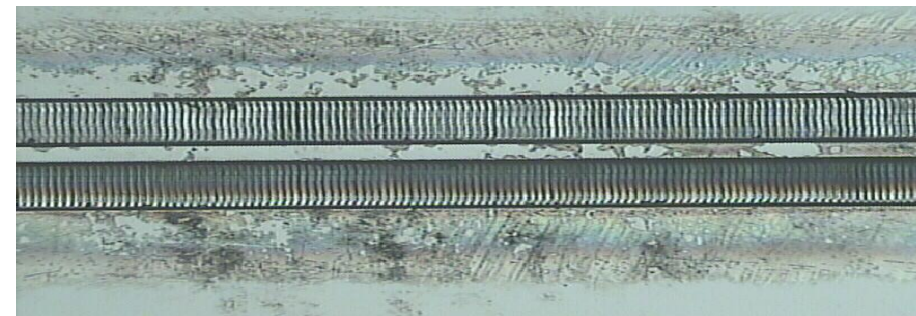

Plan View

Inkjetting as a Route to Waveguide Deposition

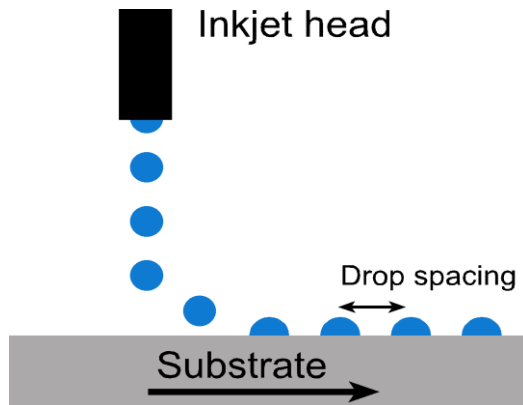

- Print polymer then UV cure
- Advantages:
 - controlled, selective deposition of core and clad
 - less wastage: picolitre volumes
 - large area printing
 - low cost

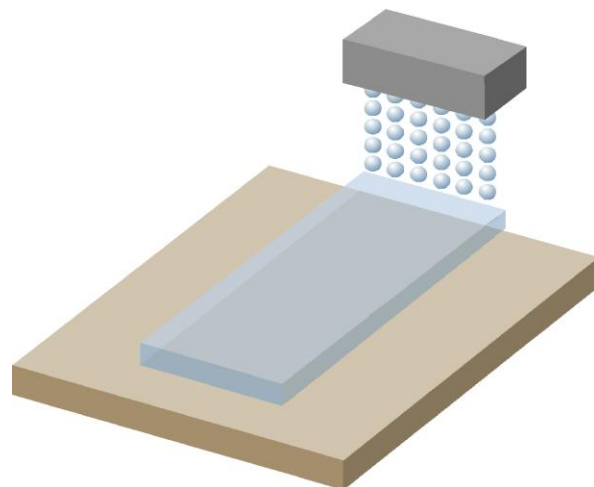

**Deposit
Lower Cladding**

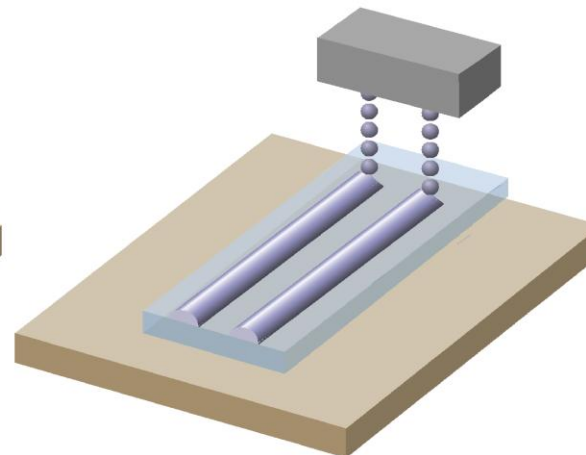

**Deposit
Core**

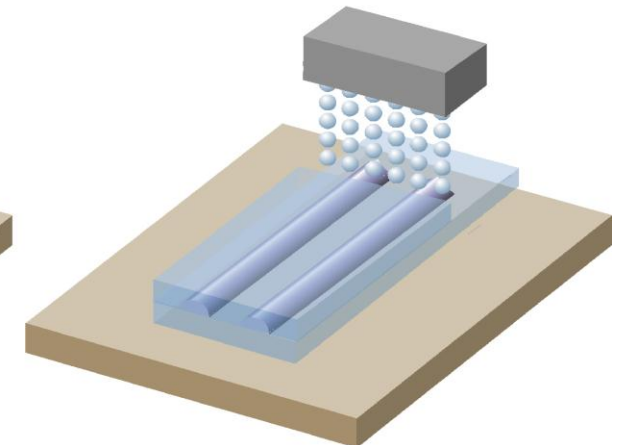

**Deposit
Upper Cladding**

Challenges of Inkjet Deposition

- Viscosity tailored to inkjet head via addition of solvent
- “Coffee stain” effects

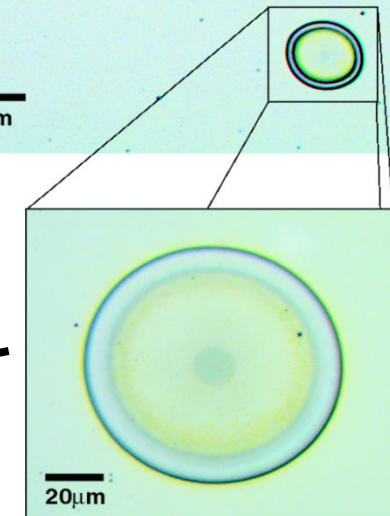
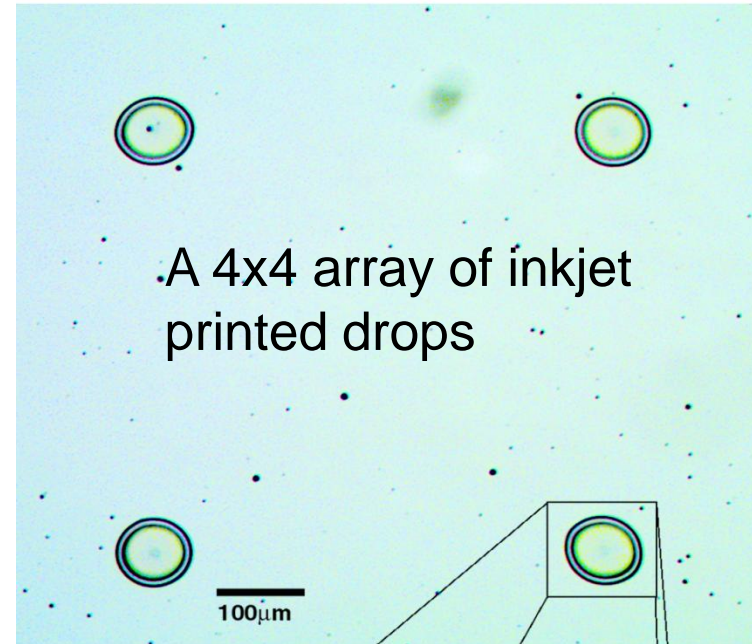
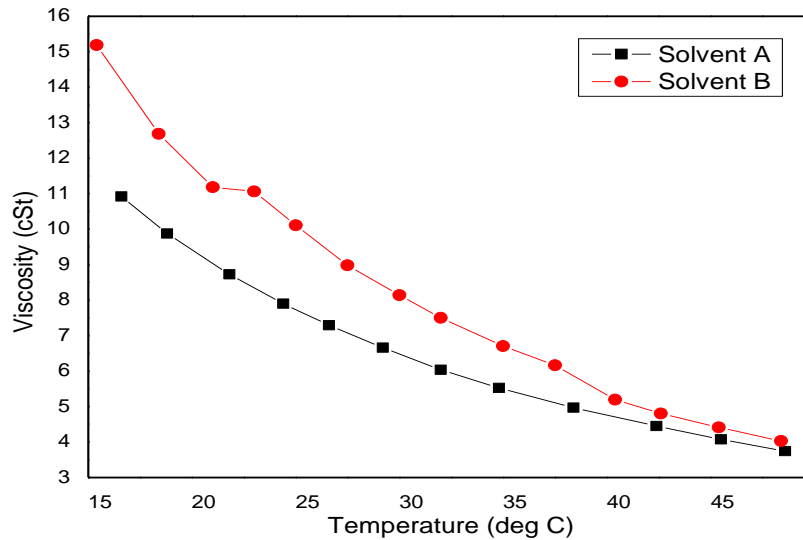

Cross-section of dried droplet
“coffee-stain” effect



Changing Surface Wettability

Contact Angles

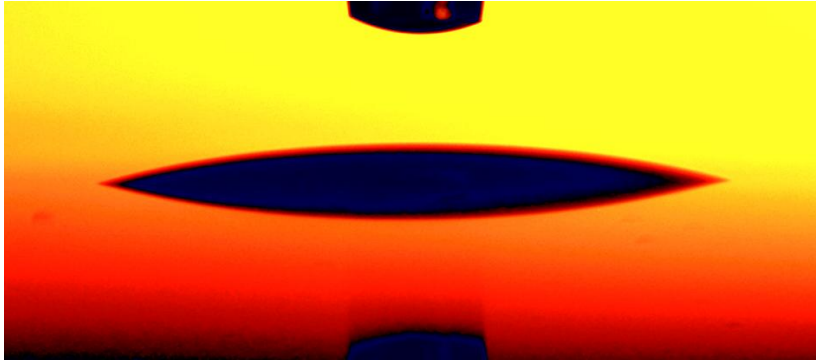

Core material on cladding

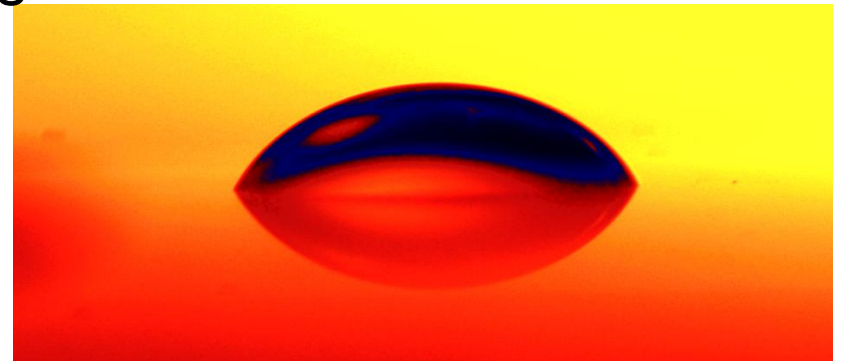

Core material on modified glass surface (hydrophobic)

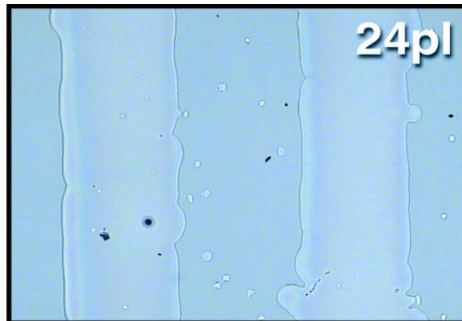
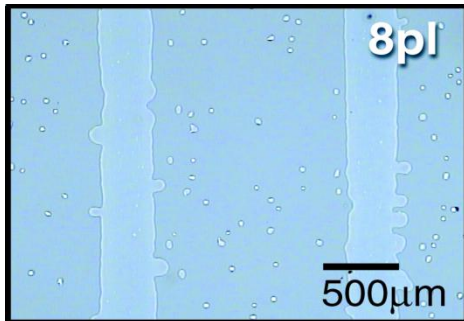

Large wetting - broad inkjetted lines

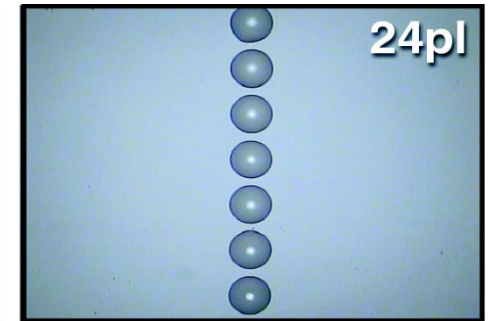
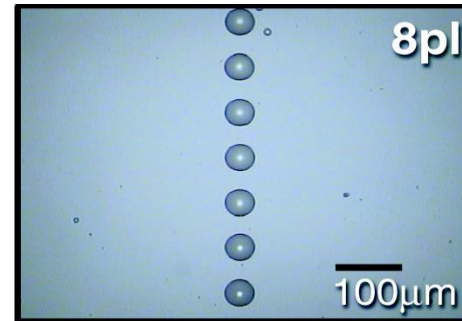

Reduced wetting – discrete droplets

Identical inkjetting conditions - spreading inhibited on modified surface

Towards Stable Structures

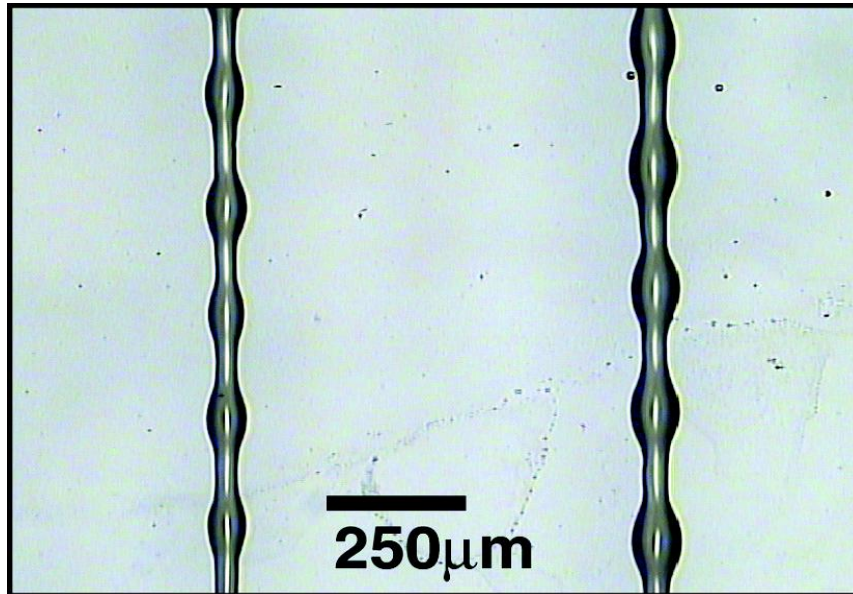

Stable line structures with periodic features

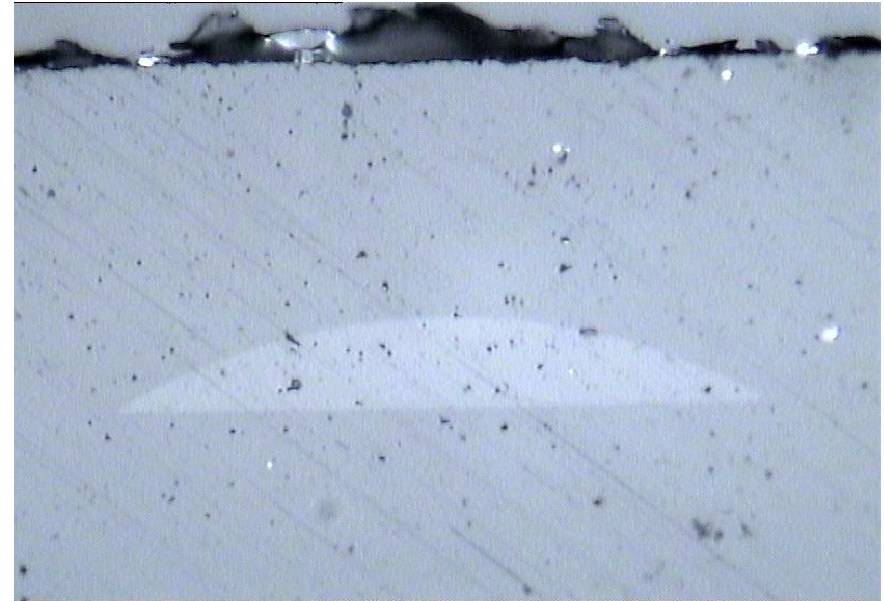

Cross section of inkjetted core material surrounded by cladding (width 80 microns)

A balance between wettability, line stability and adhesion

Waveguide components and measurements

- Straight waveguides 480 mm x 70 μm x 70 μm
- Bends with a range of radii
- Crossings
- Spiral waveguides
- Tapered waveguides
- Bent tapered waveguides
- Loss
- Crosstalk
- Misalignment tolerance
- Surface Roughness
- Bit Error Rate, Eye Diagram

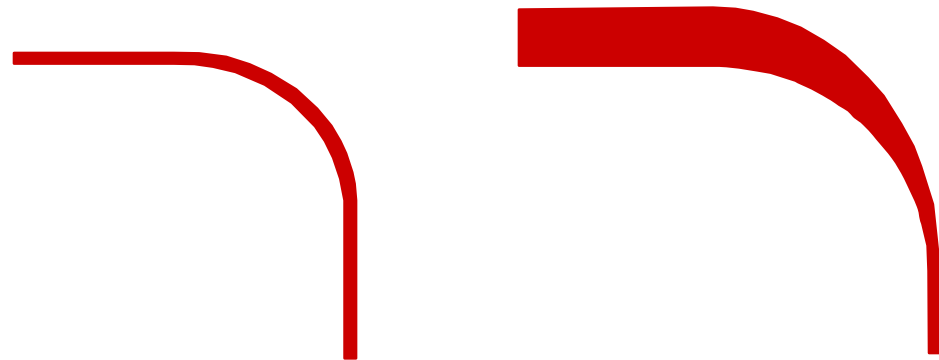
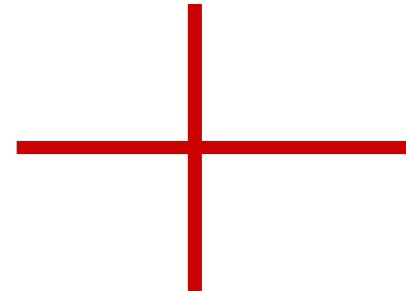

Optical Power Loss in 90° Waveguide Bends

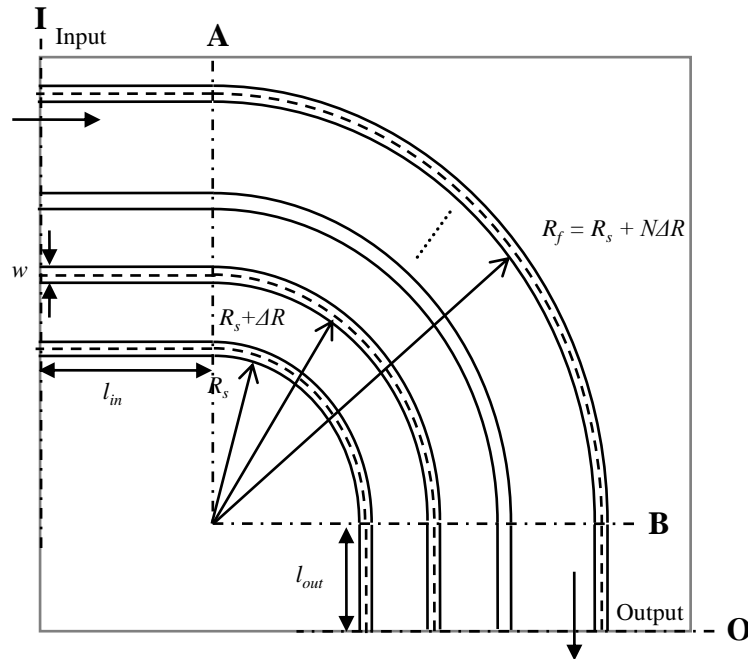

Schematic diagram of one set of curved waveguides.

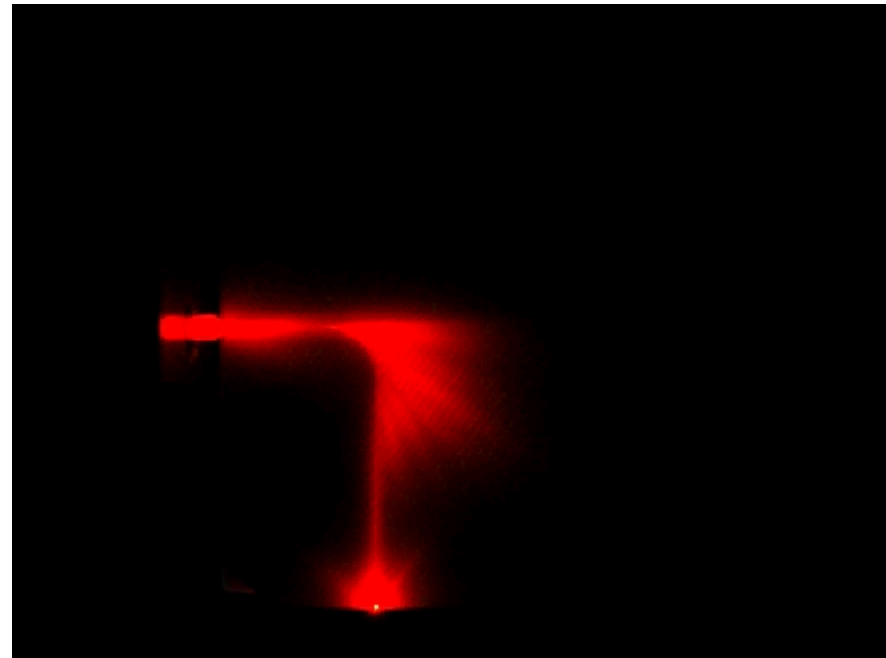

Light through a bent waveguide of $R = 5.5 \text{ mm} - 34.5 \text{ mm}$

- Radius R , varied between $5.5 \text{ mm} < R < 35 \text{ mm}$, $\Delta R = 1 \text{ mm}$
- Light lost due to scattering, transition loss, bend loss, reflection and back-scattering
- Illuminated by a MM fiber with a red-laser.

BPM, beam propagation method modeling of optical field in bend segments

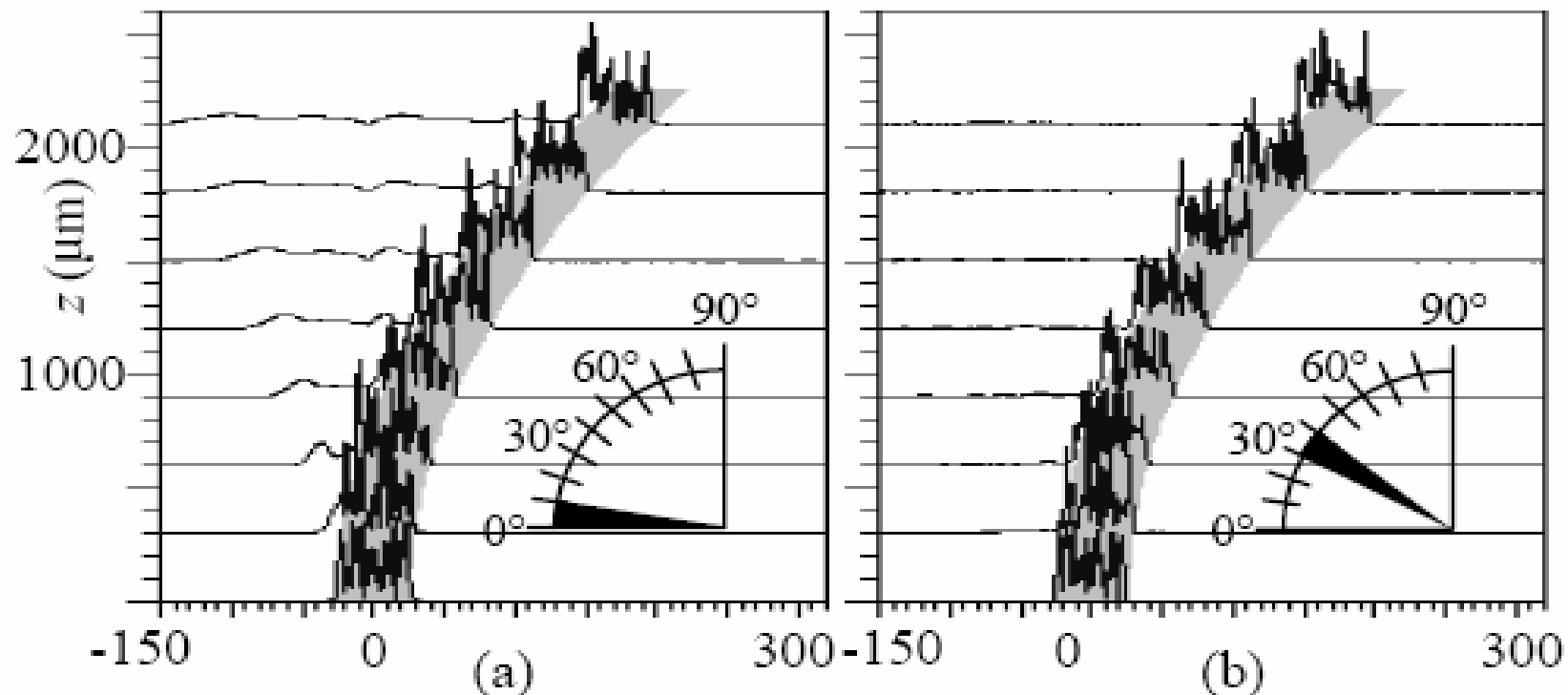

$w = 50 \mu\text{m}$, $R = 13 \text{ mm}$

(left picture) in the first segment (first 10°).

(right picture) in the 30° to 40° degree segment.

Differences in misalignment tolerance and loss as a function of taper ratio

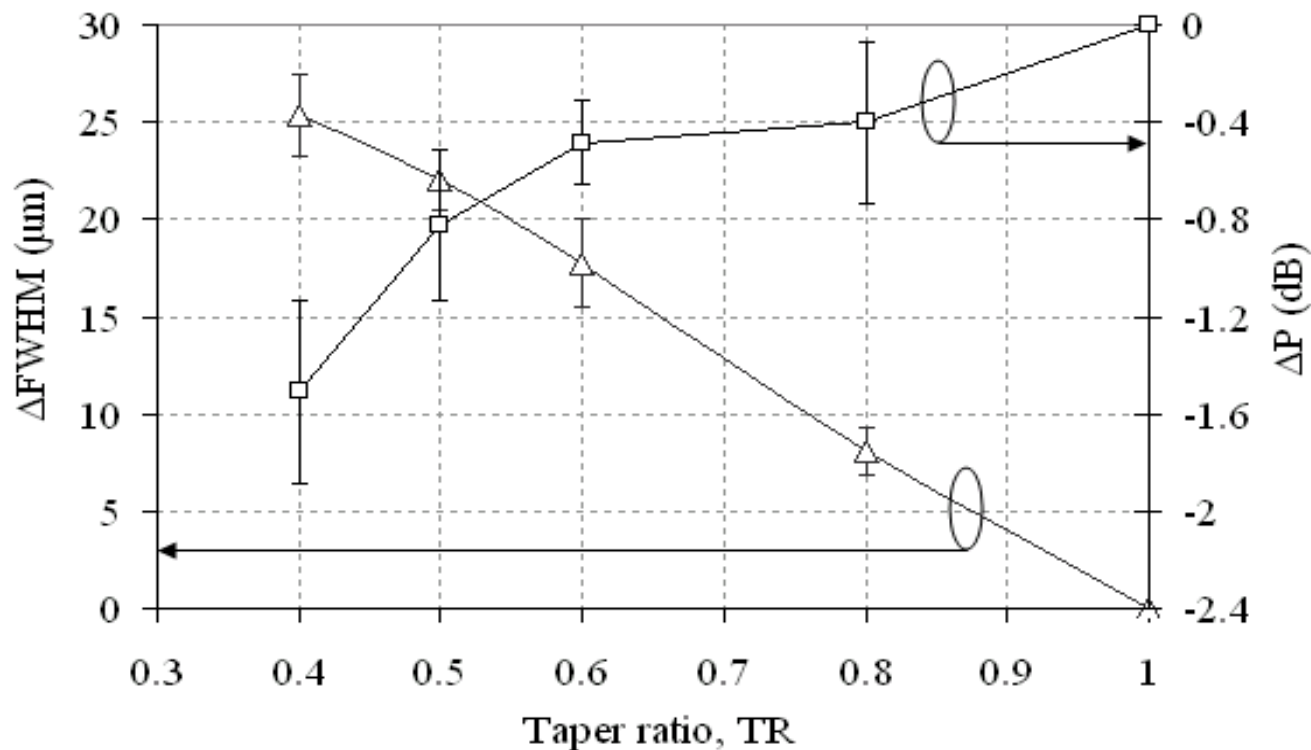

- Graph plots the differences between a tapered bend and a bend
- There is a trade off between insertion loss and misalignment tolerance

Crosstalk in Chirped Width Waveguide Array

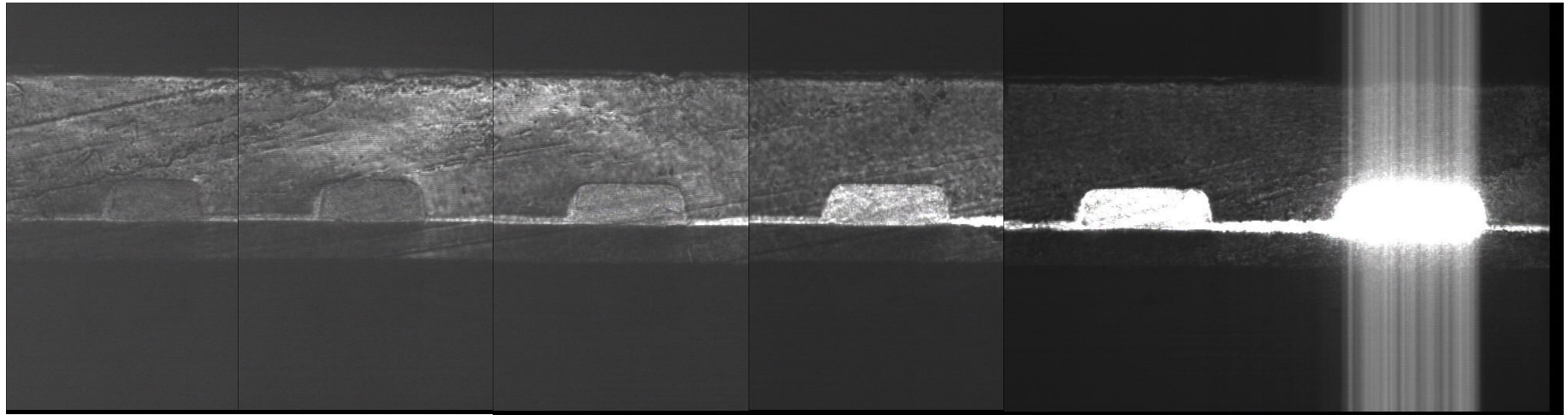

100 μm 110 μm 120 μm 130 μm 140 μm 150 μm

- Light launched from VCSEL imaged via a GRIN lens into 50 μm x 150 μm waveguide
- Photolithographically fabricated chirped with waveguide array
- Photomosaic with increased camera gain towards left

Surface roughness

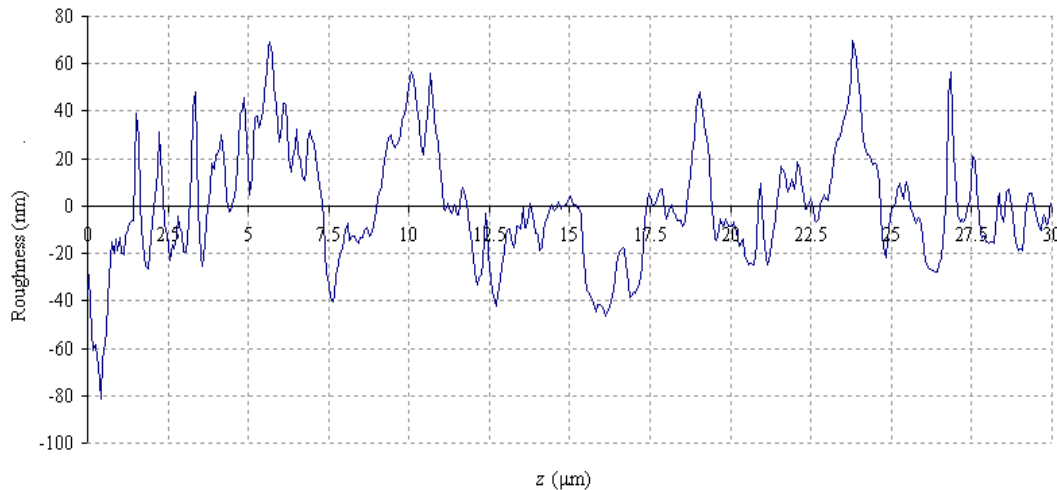

- RMS side wall roughness: 9 nm to 74 nm



- RMS polished end surface roughness: 26 nm to 192 nm.

Design rules for waveguide width depending on insertion loss and cross-talk

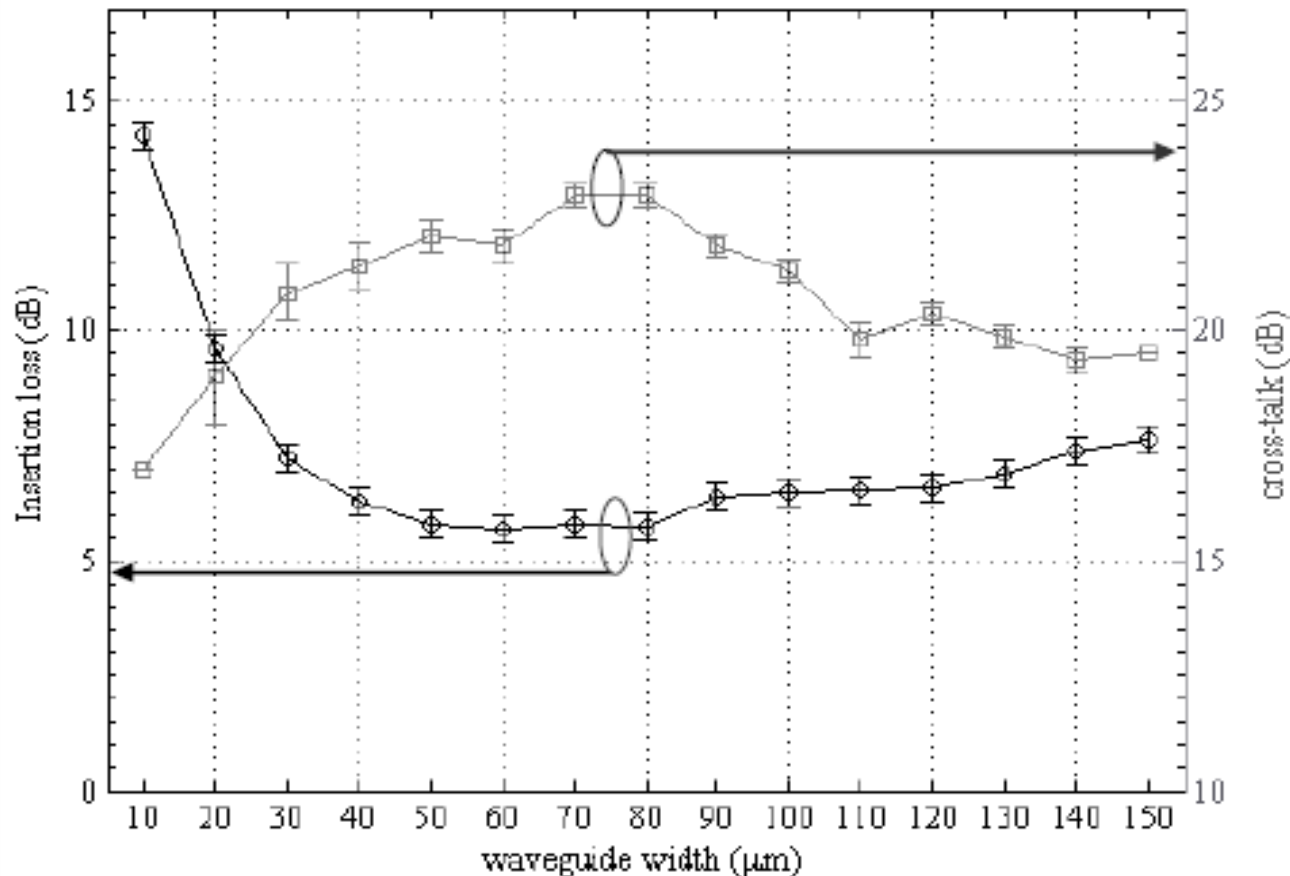

6~7dB for a 70 μm width waveguide

Bit error rate for laterally misaligned 1550 nm 2.5 Gb/s DFB laser

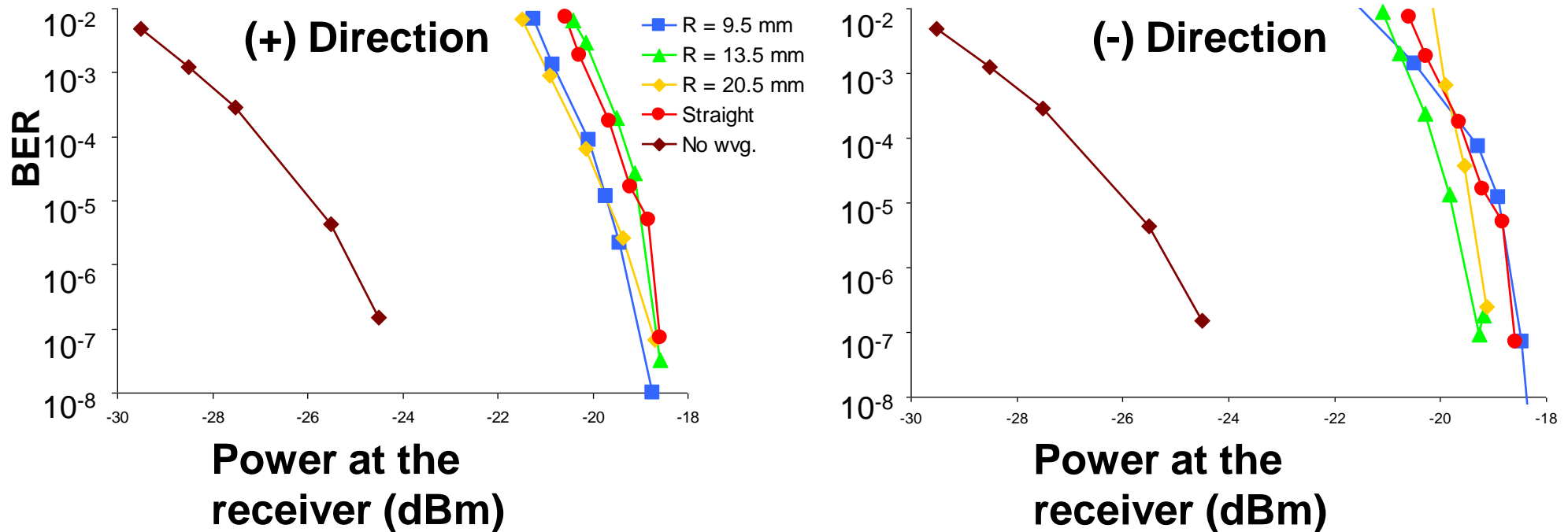

Contour map of VCSEL and PD misalignment

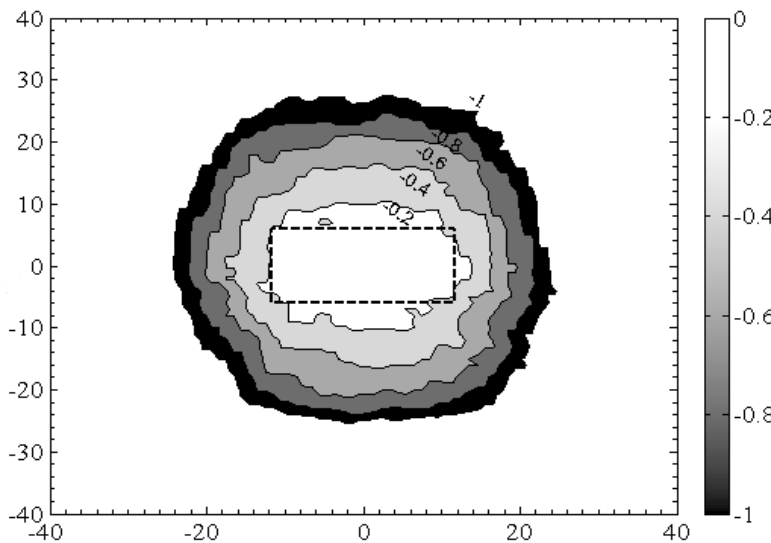

(a) Contour map of relative insertion loss compared to the maximum coupling position for VCSEL misalignment at $z = 0$.

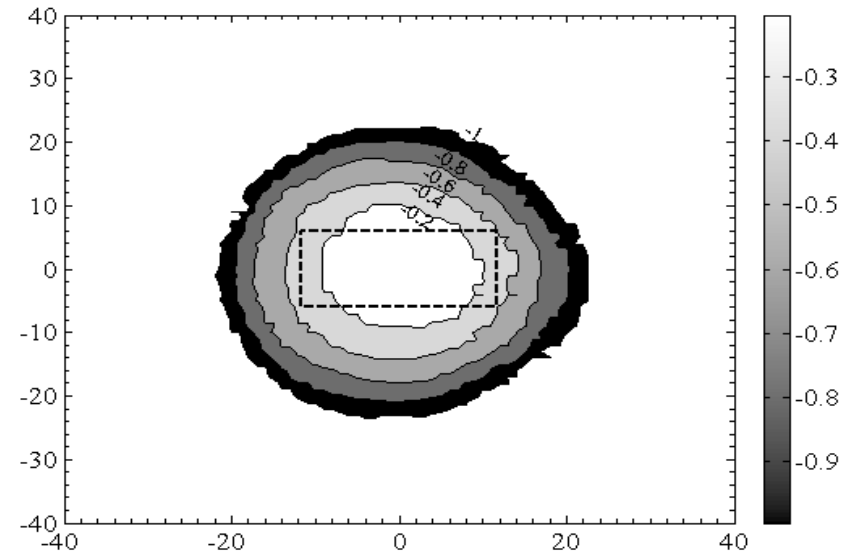

(b) Same for PD misalignment at $z = 0$. Resolution step was $\Delta x = \Delta y = 1 \mu\text{m}$.

- Dashed rectangle is the expected relative insertion loss according to the calculated misalignments along x and y .
- The minimum insertion loss was 4.4 dB, corresponded to $x = 0, y = 0, z = 0$

Coupling Loss for VCSEL and PD for misalignments along optic axis

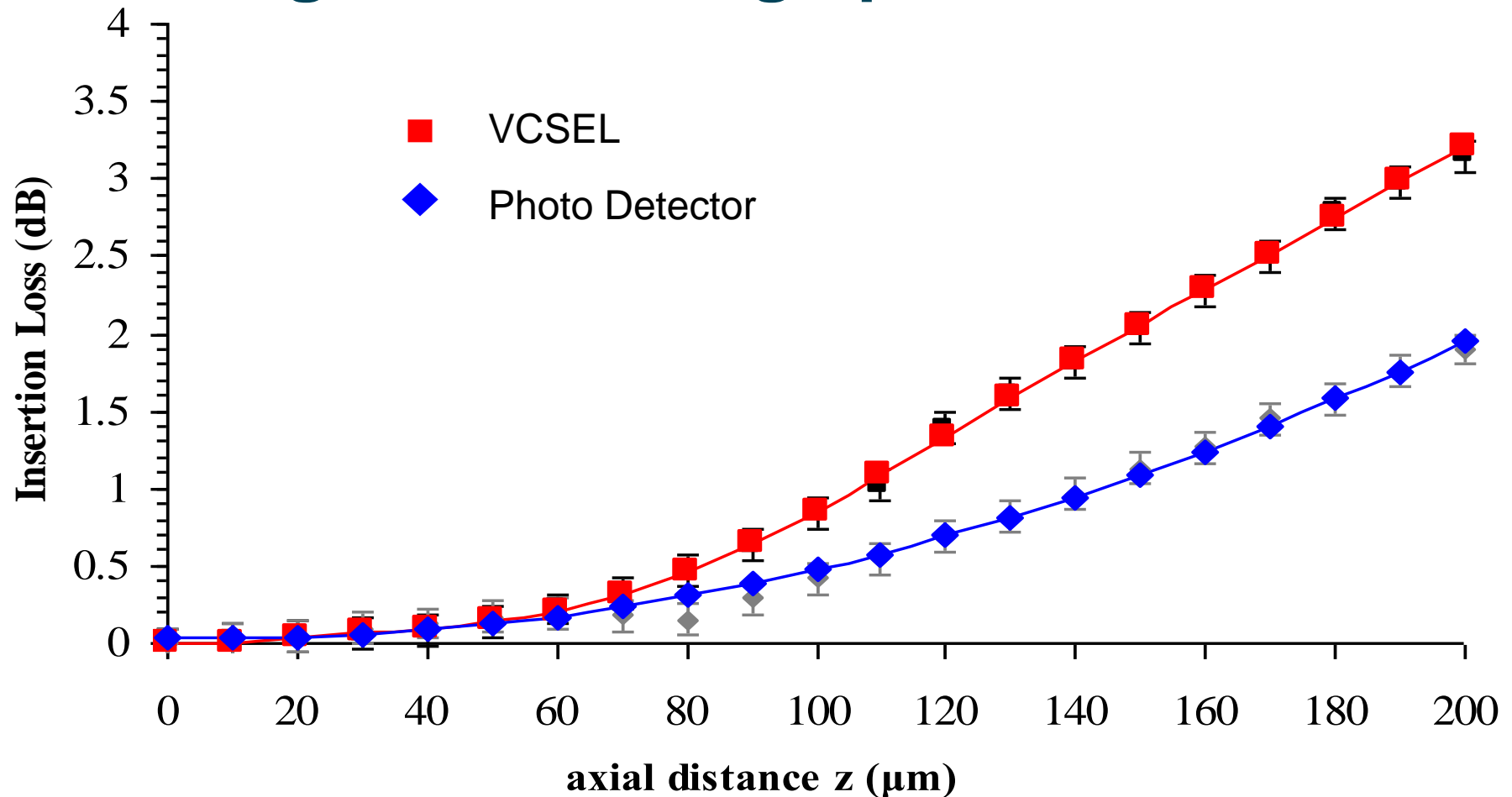

Fabrication Techniques and Waveguides Samples



Straight waveguides – Optical InterLinks

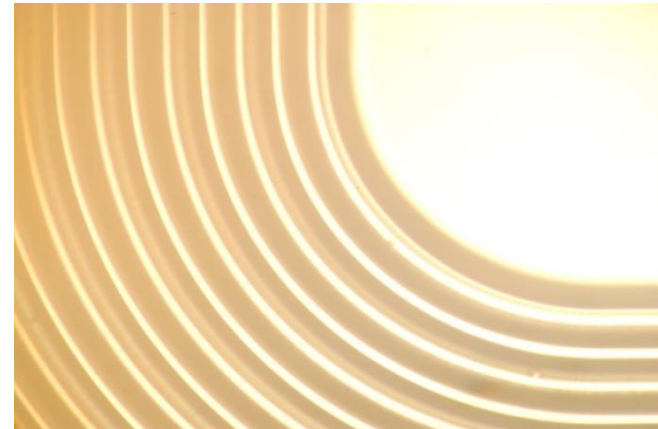

90° Crossings – Dow Corning

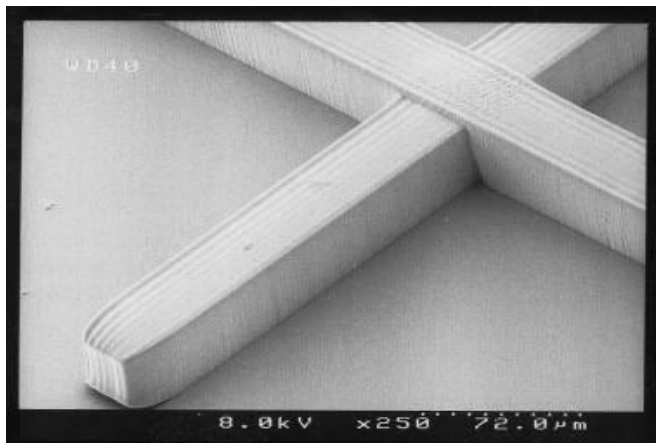

90° Crossings – Heriot Watt University

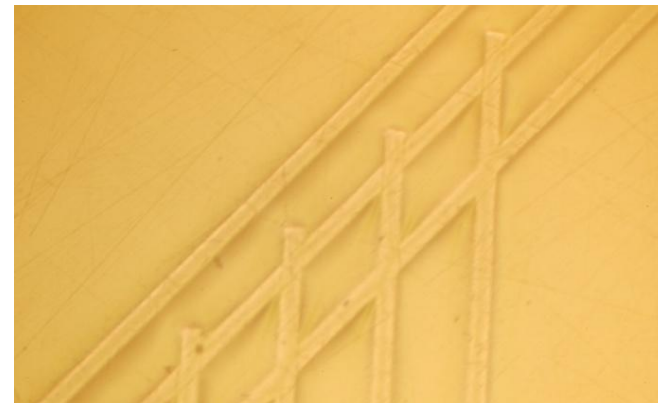

50° Crossings – Exxelis

Photolithographic Fabrication of Waveguides

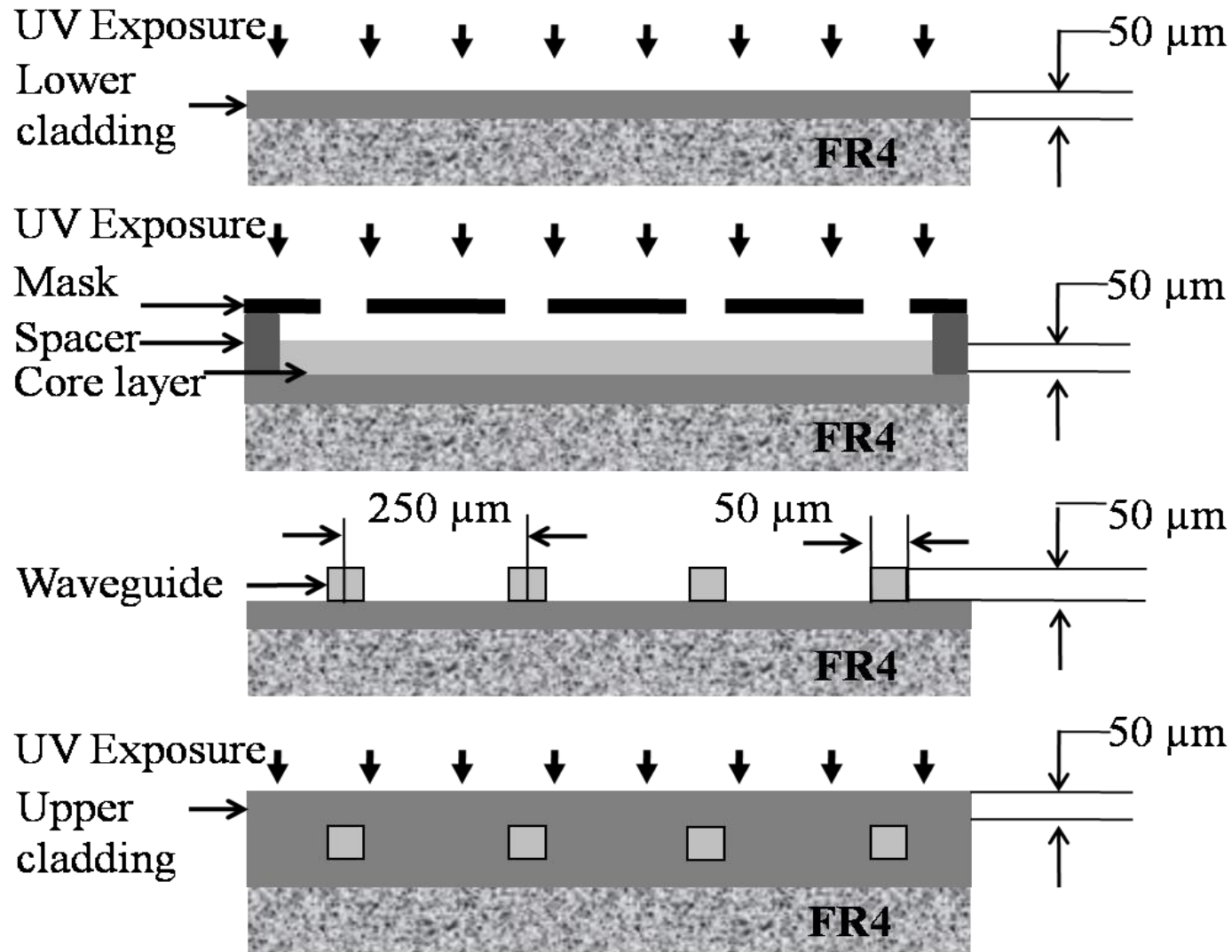

Optical Loss Measurement

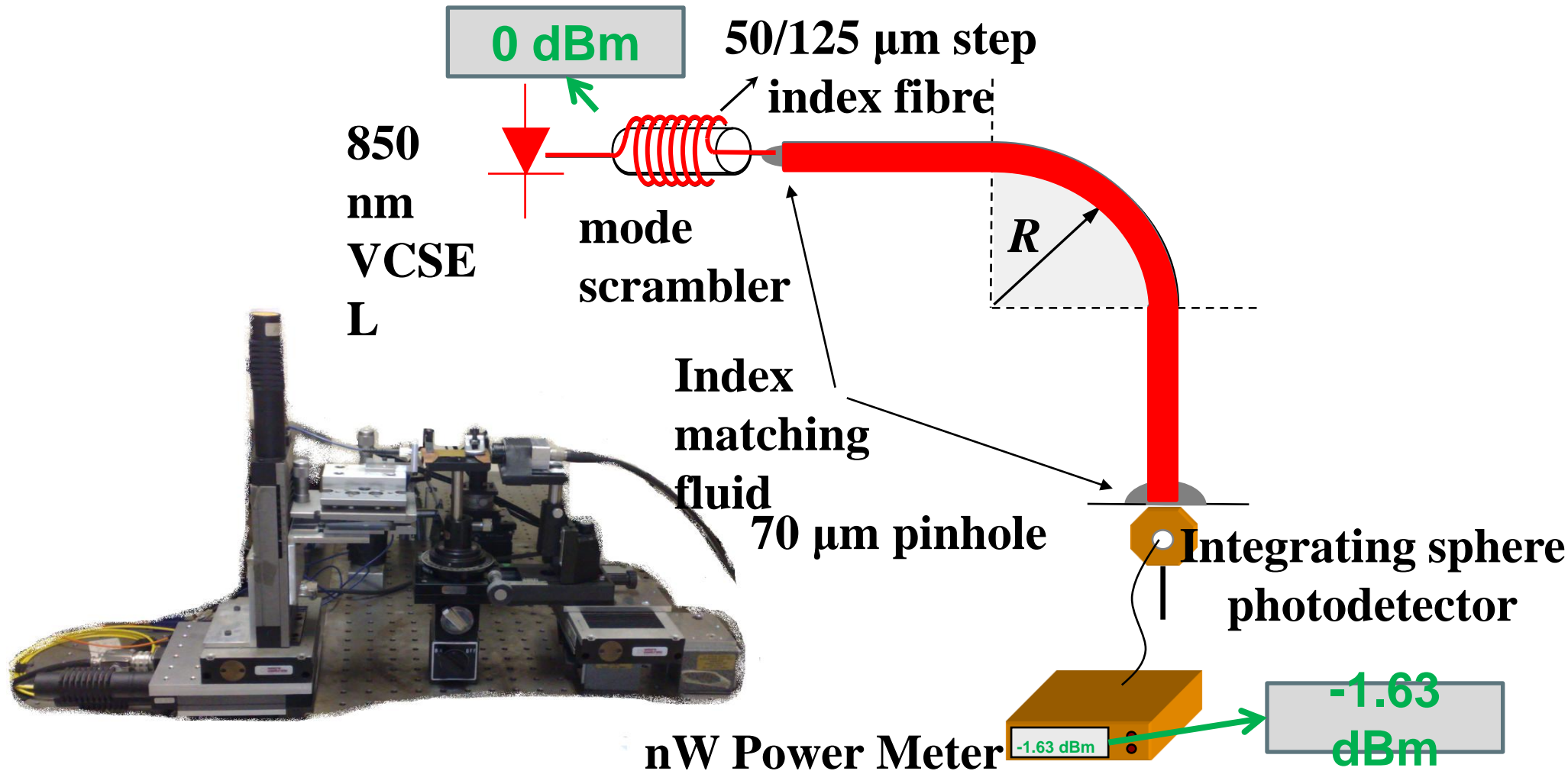

VCSEL Array for Crosstalk Measurement

PIN Array



Source: Microsemi Corporation

VCSEL Array



Source: ULM Photonics GmbH

GRIN Lens Array

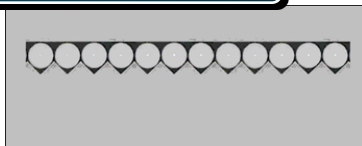

Source: GRINTech GmbH

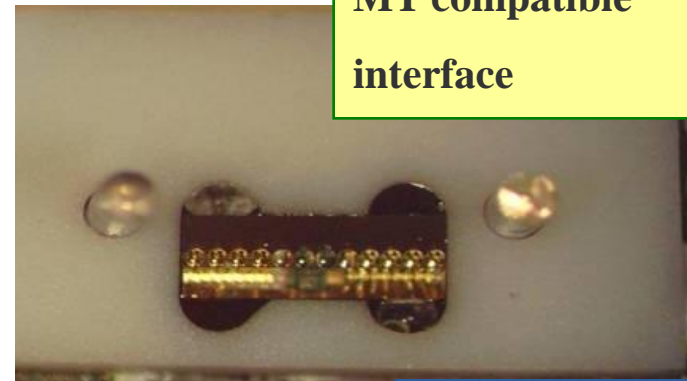
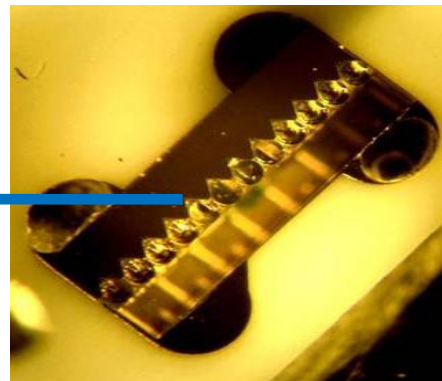

Design Rules for Inter-waveguide Cross Talk

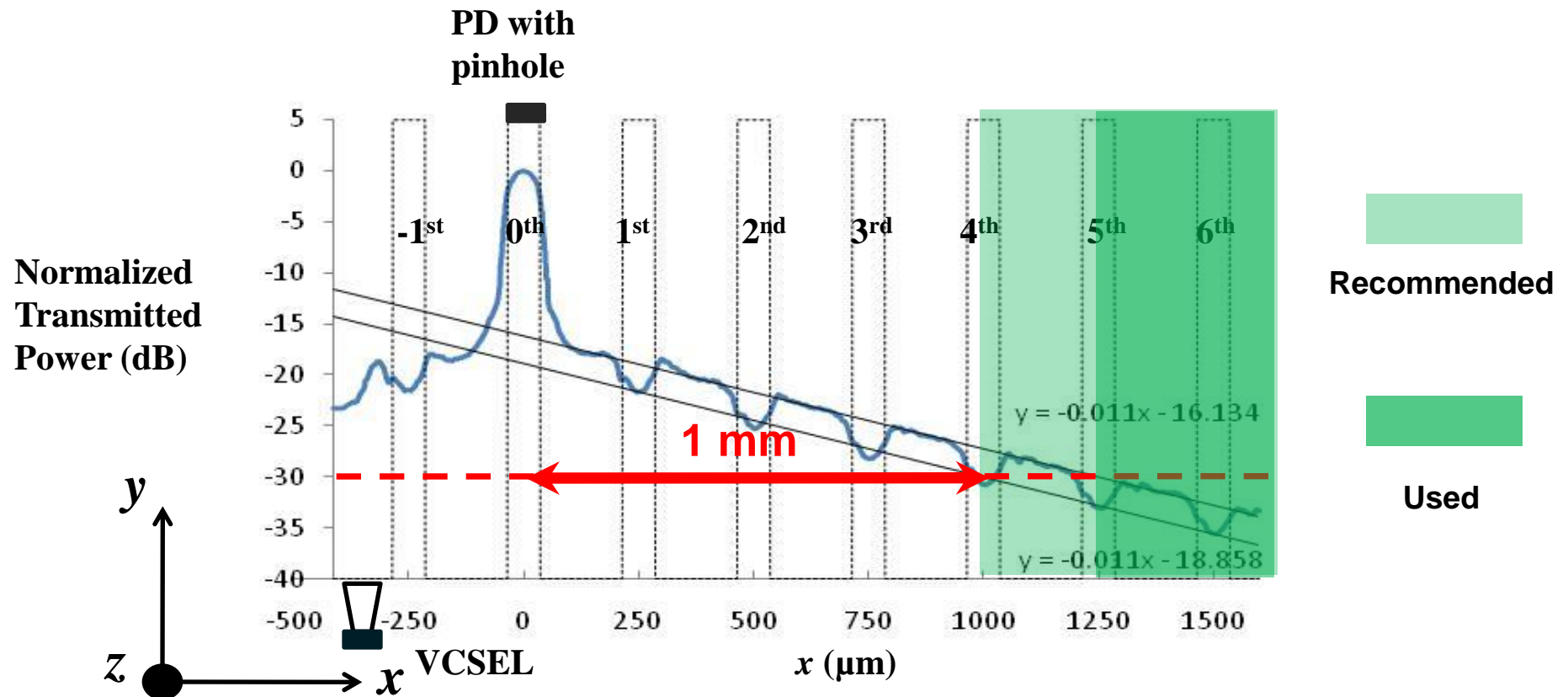

- $70 \mu\text{m} \times 70 \mu\text{m}$ waveguide cross sections and 10 cm long
- In the cladding power drops linearly at a rate of $0.011 \text{ dB}/\mu\text{m}$
- Crosstalk reduced to -30 dB for waveguides 1 mm apart

Schematic Diagram Of Waveguide Crossings at 90° and at an Arbitrary Angle, θ

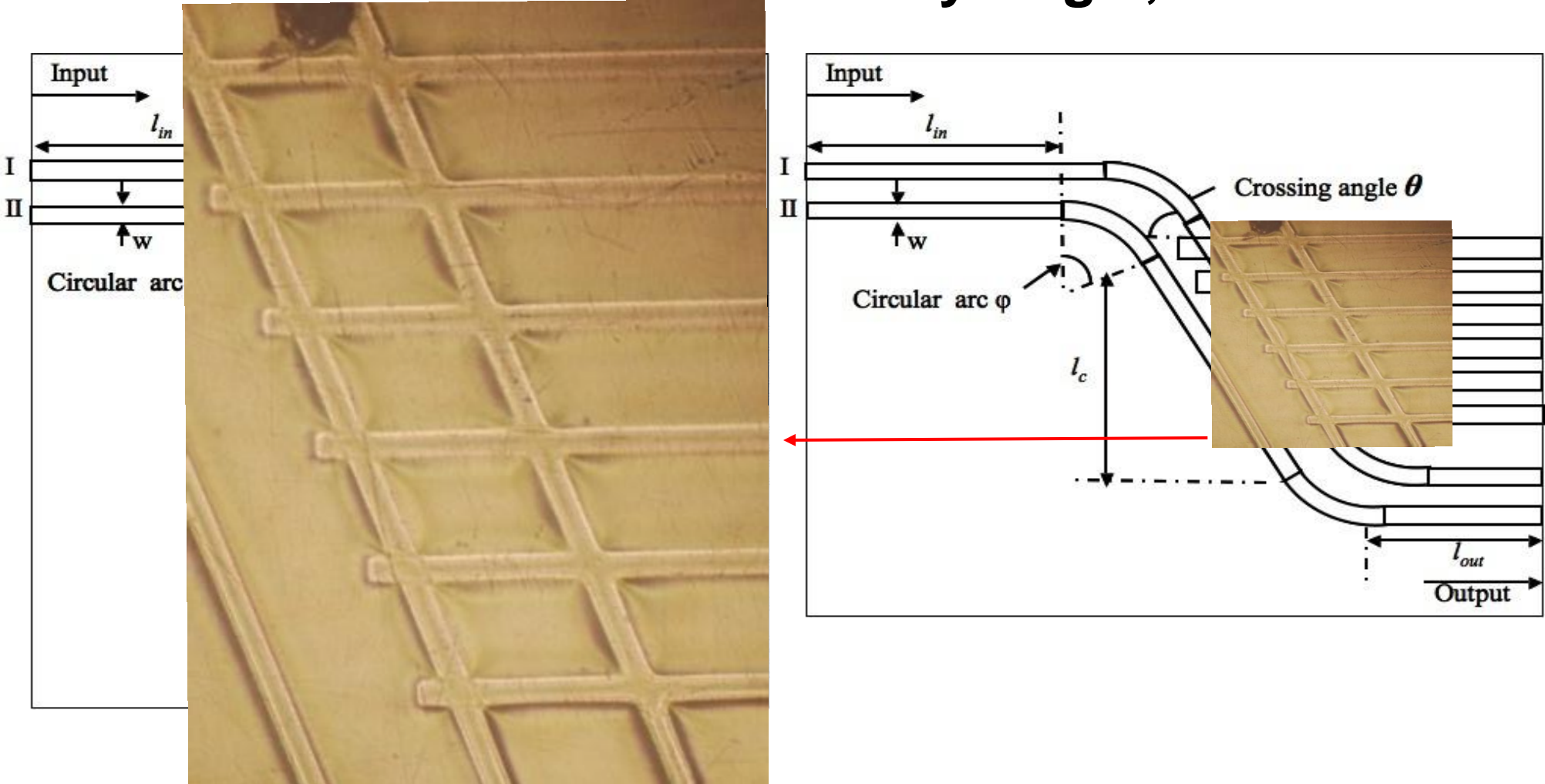

Design Rules for Arbitrary Angle Crossings

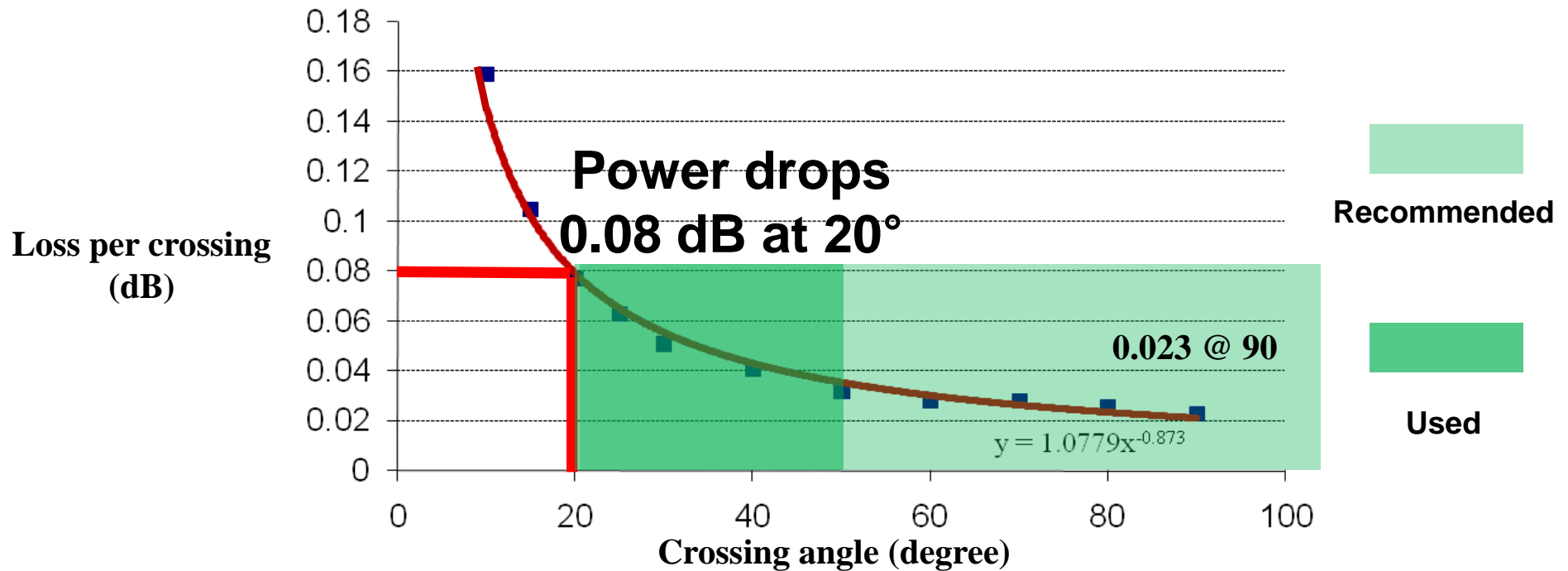

- Loss of 0.023 dB per 90° crossing consistent with other reports
- The output power dropped by 0.5% at each 90° crossing
- The loss per crossing (L_c) depends on crossing angle (θ), $L_c = 1.0779 \cdot \theta^{-0.8727}$.

Loss of Waveguide Bends

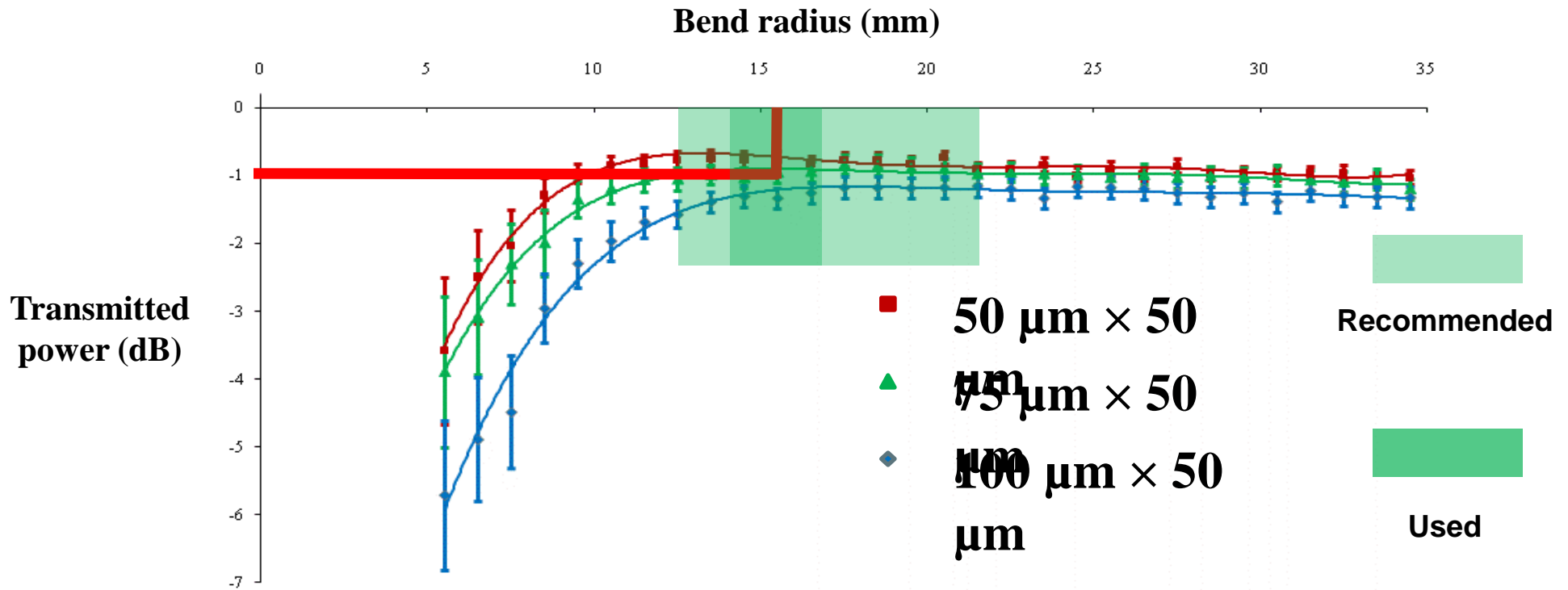

Width (μm)	Optimum Radius (mm)	Maximum Power (dB)
50	13.5	-0.74
75	15.3	-0.91
100	17.7	-1.18

System Demonstrator

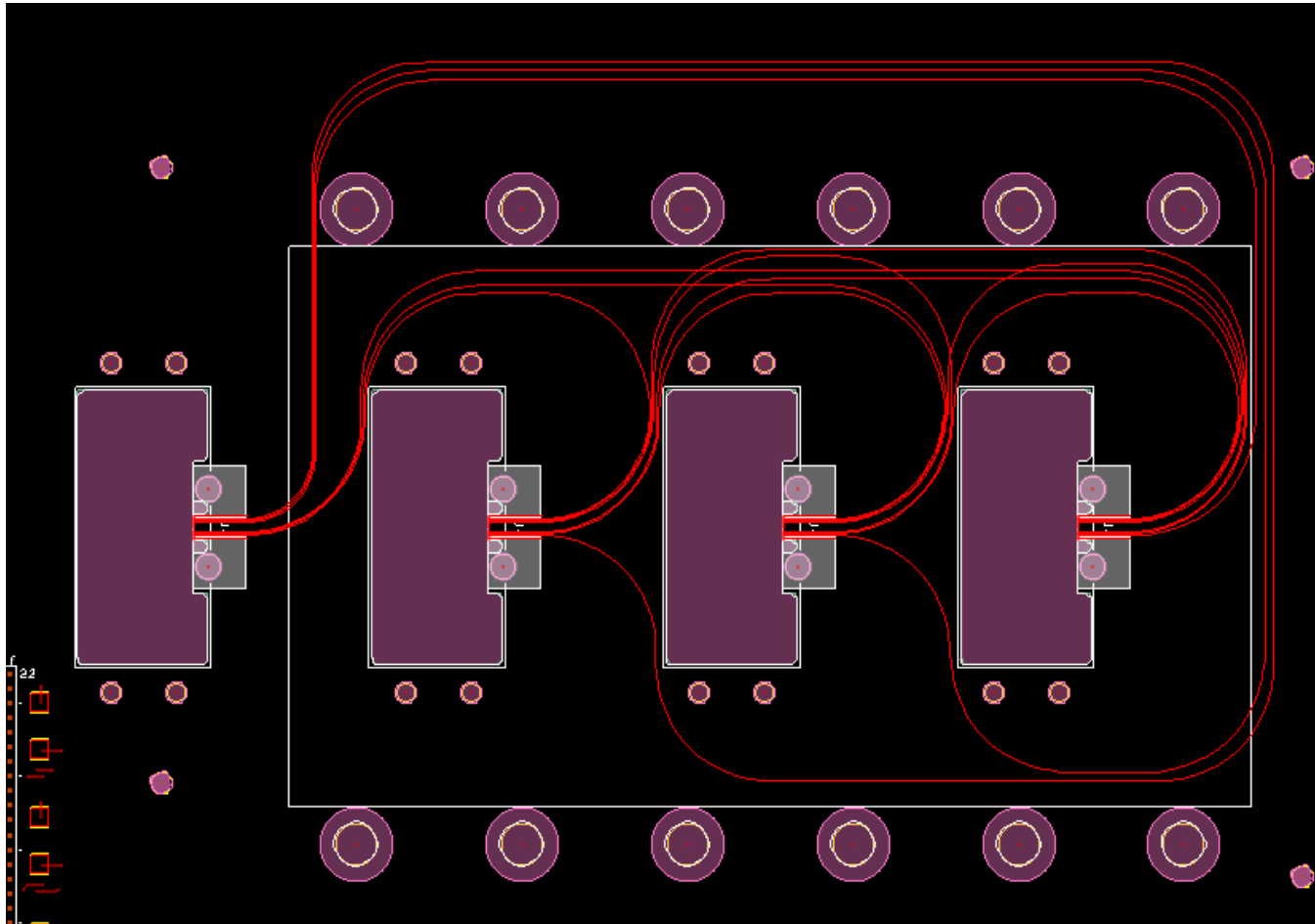

Fully connected waveguide layout using design rules

Power Budget

Input power (dBm/mW)	-2.07 / 0.62					
	Bend 90°					
Radii (mm)	15.000	15.250	15.500	15.725	16.000	16.250
Loss per bend (dB)	0.94	0.91	0.94	0.94	0.95	0.95
	Crossings					
Crossing angles (°)	22.27	29.45	36.23	42.10	47.36	
Loss per crossing (dB)	0.078	0.056	0.047	0.041	0.037	
Min. detectable power (dBm)	-15 / 0.03					
Min. power no bit error rate	-12 / 0.06					

Demonstrator Dummy Board

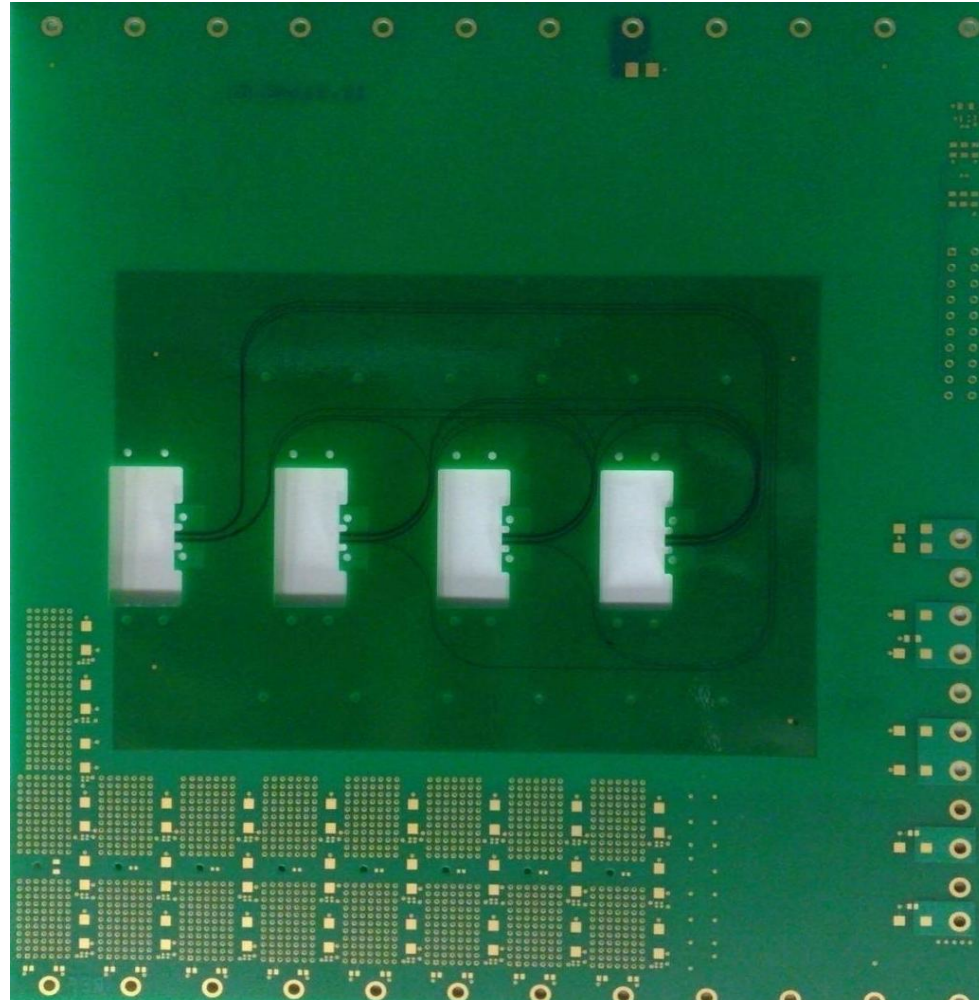

The Shortest Waveguide Illuminated by Red Laser

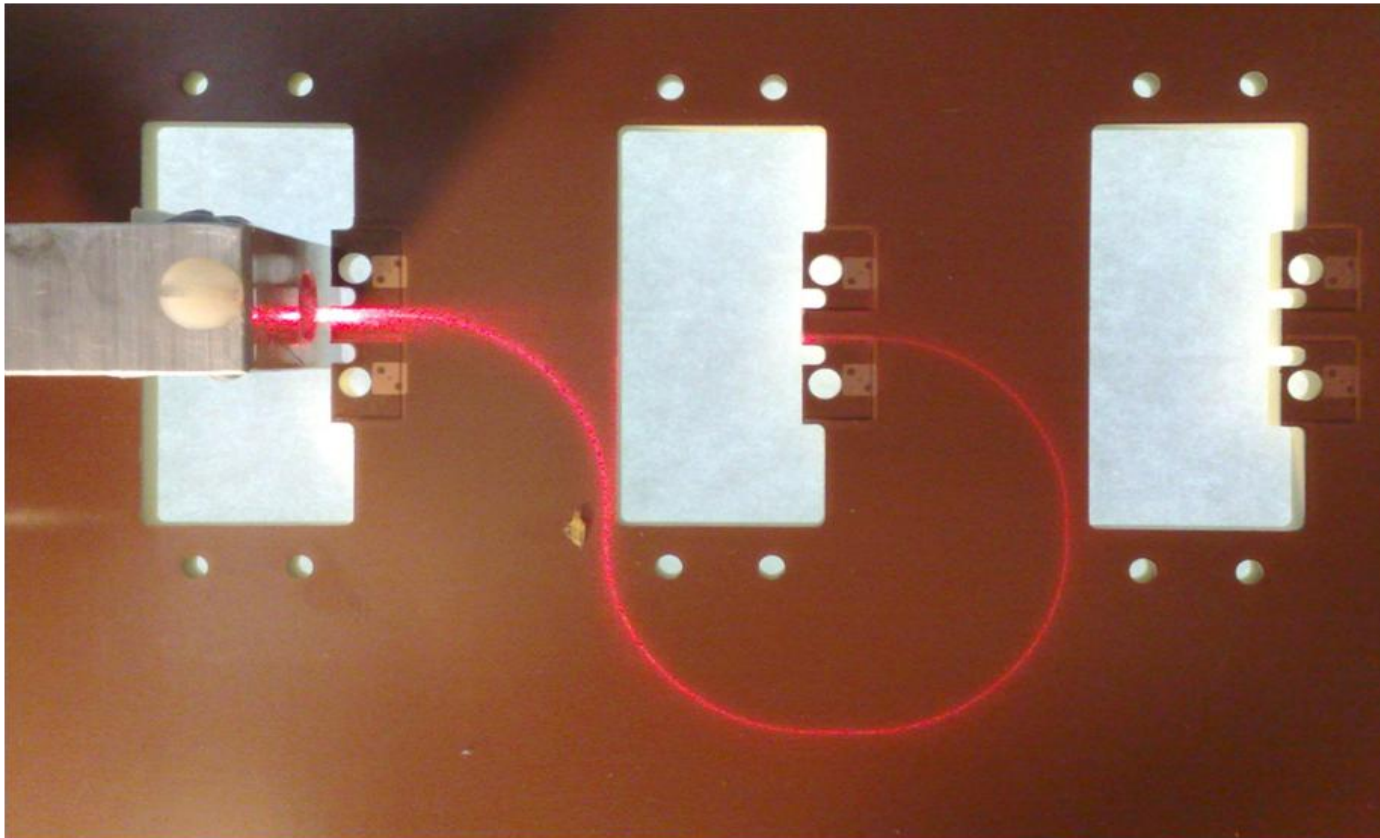

Waveguide with 2 Crossings Connected 1st to 3rd Linecard Interconnect

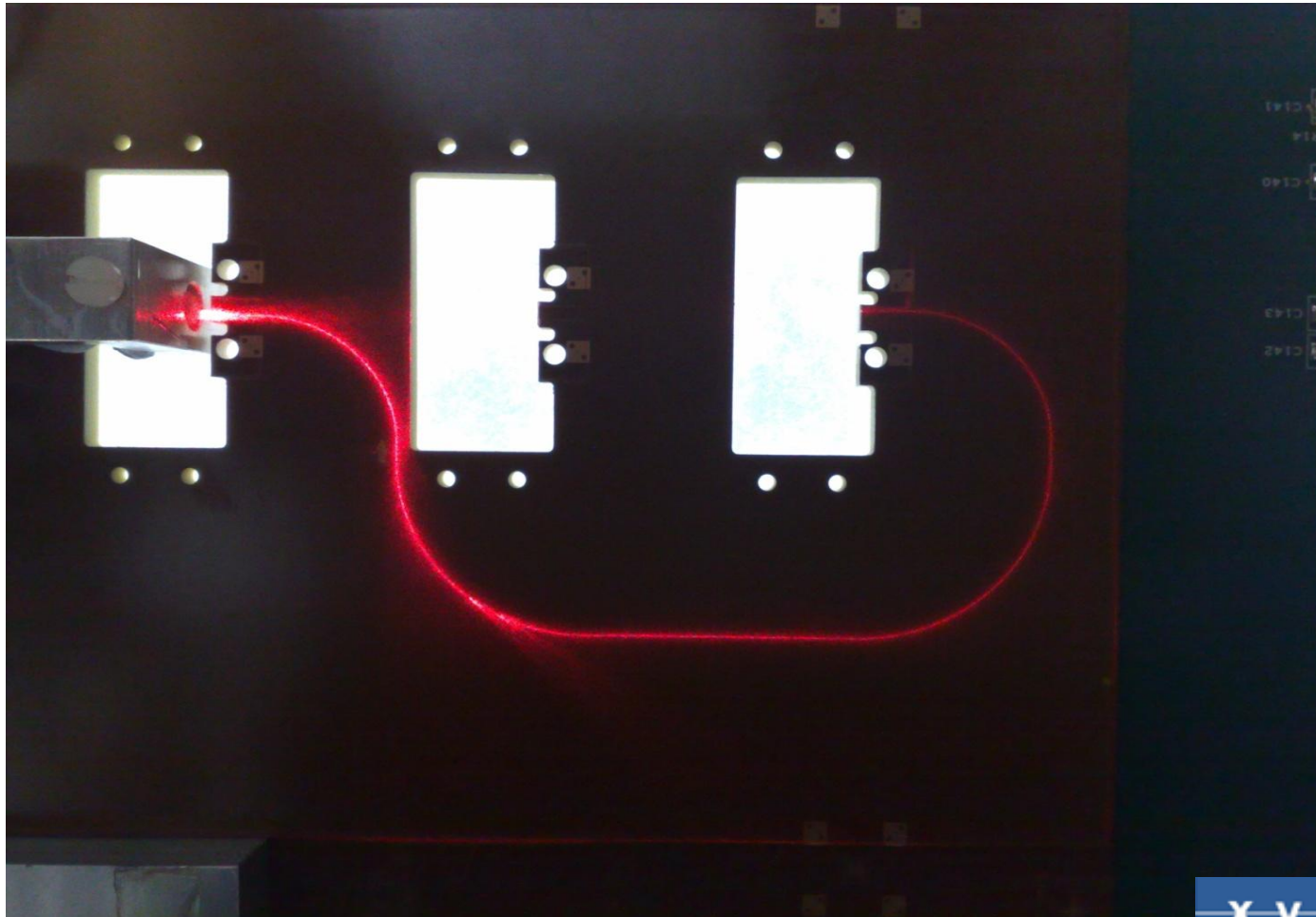

x-y-r-a-t-e-x

Output Facet of the Waveguide Interconnection

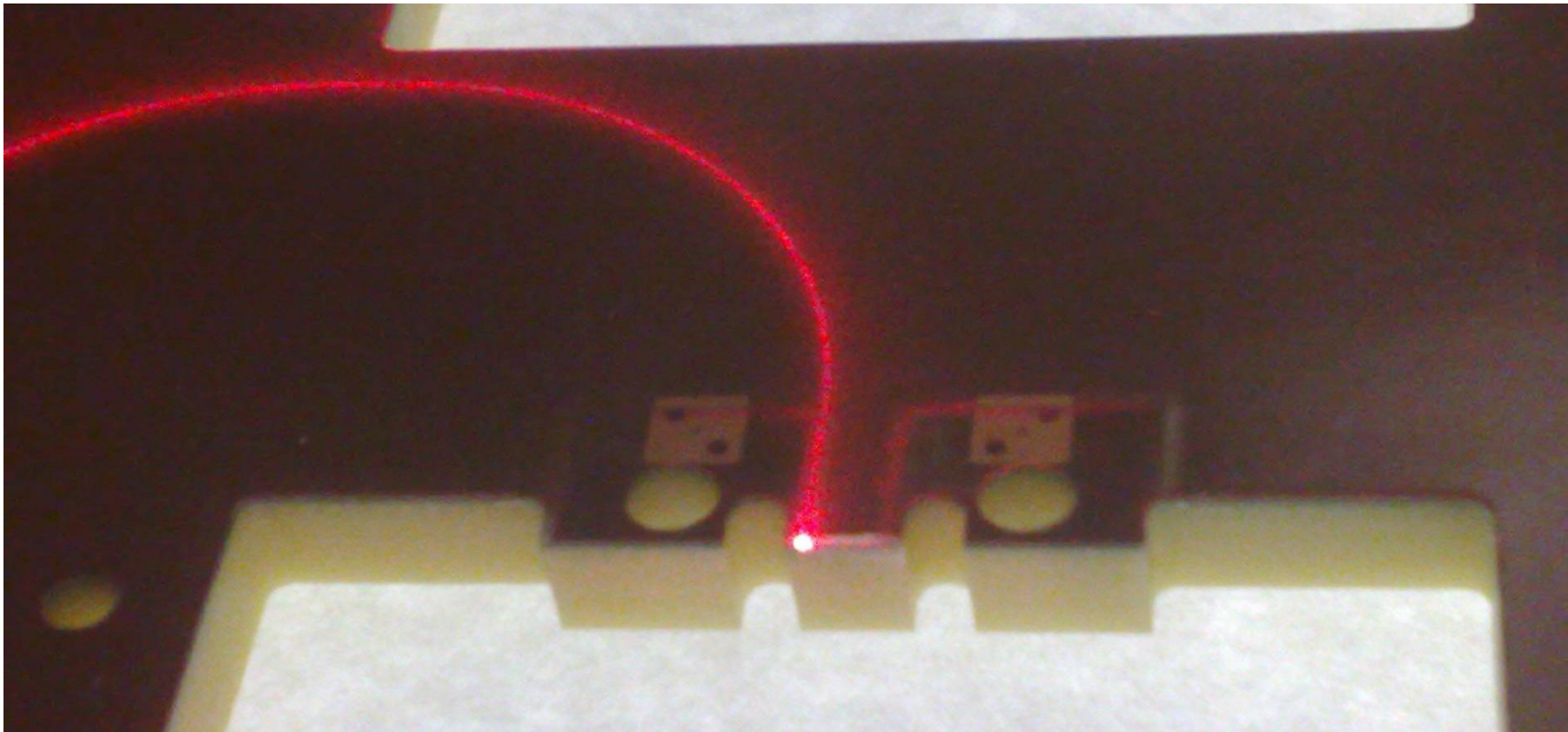

Backplane and Line Cards Orthogonal

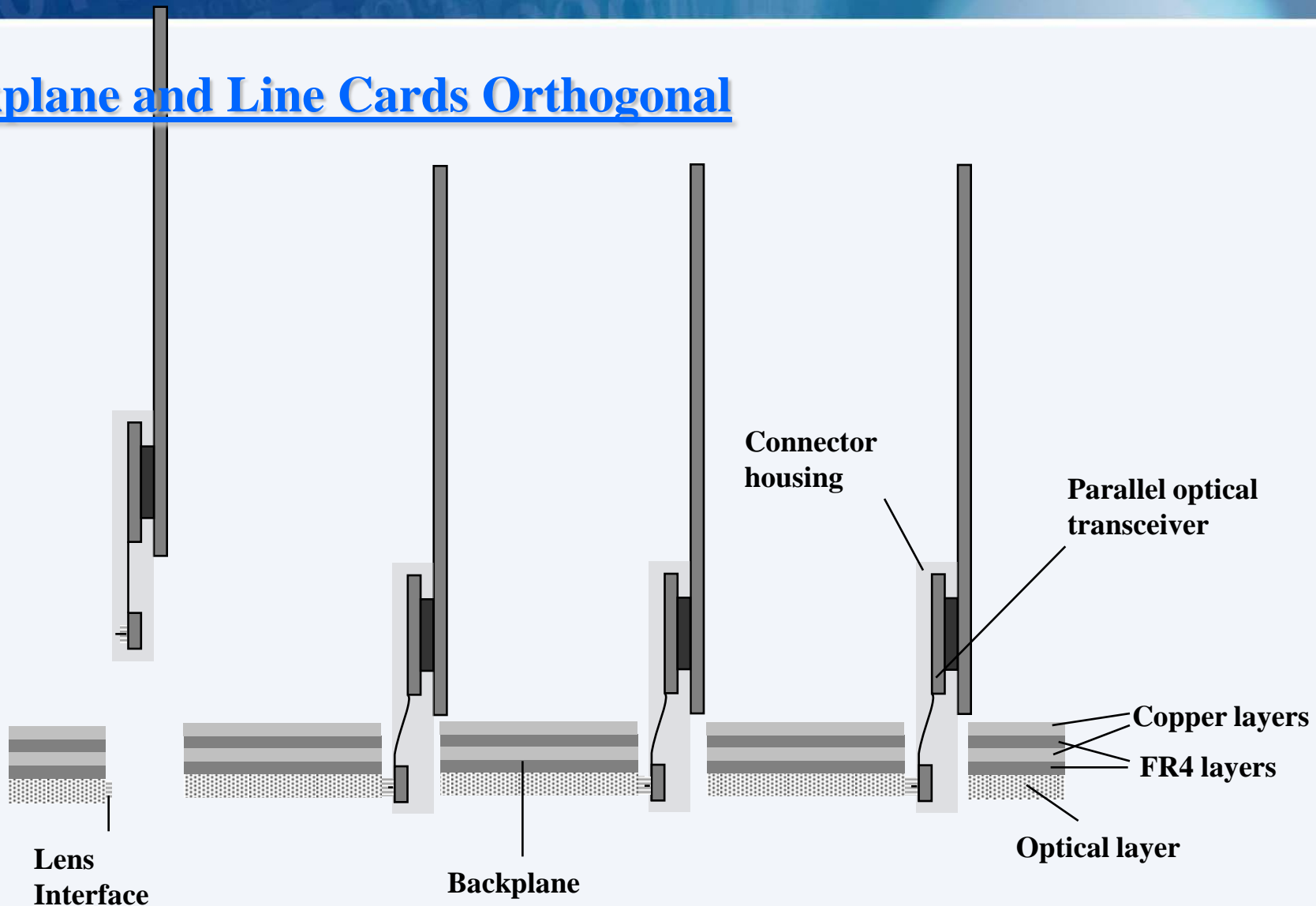

Butt-coupled connection approach without 90° deflection optics

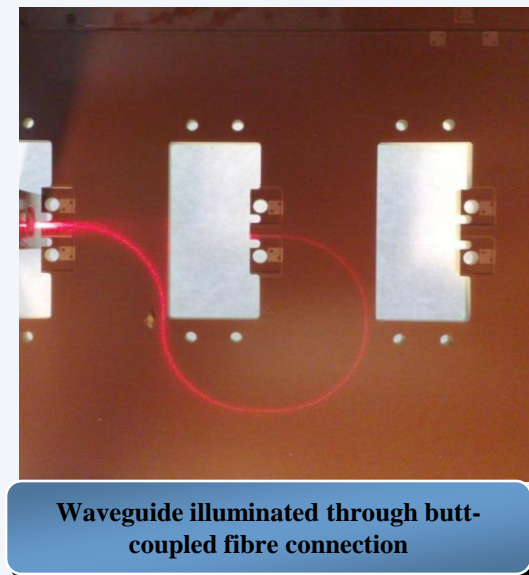
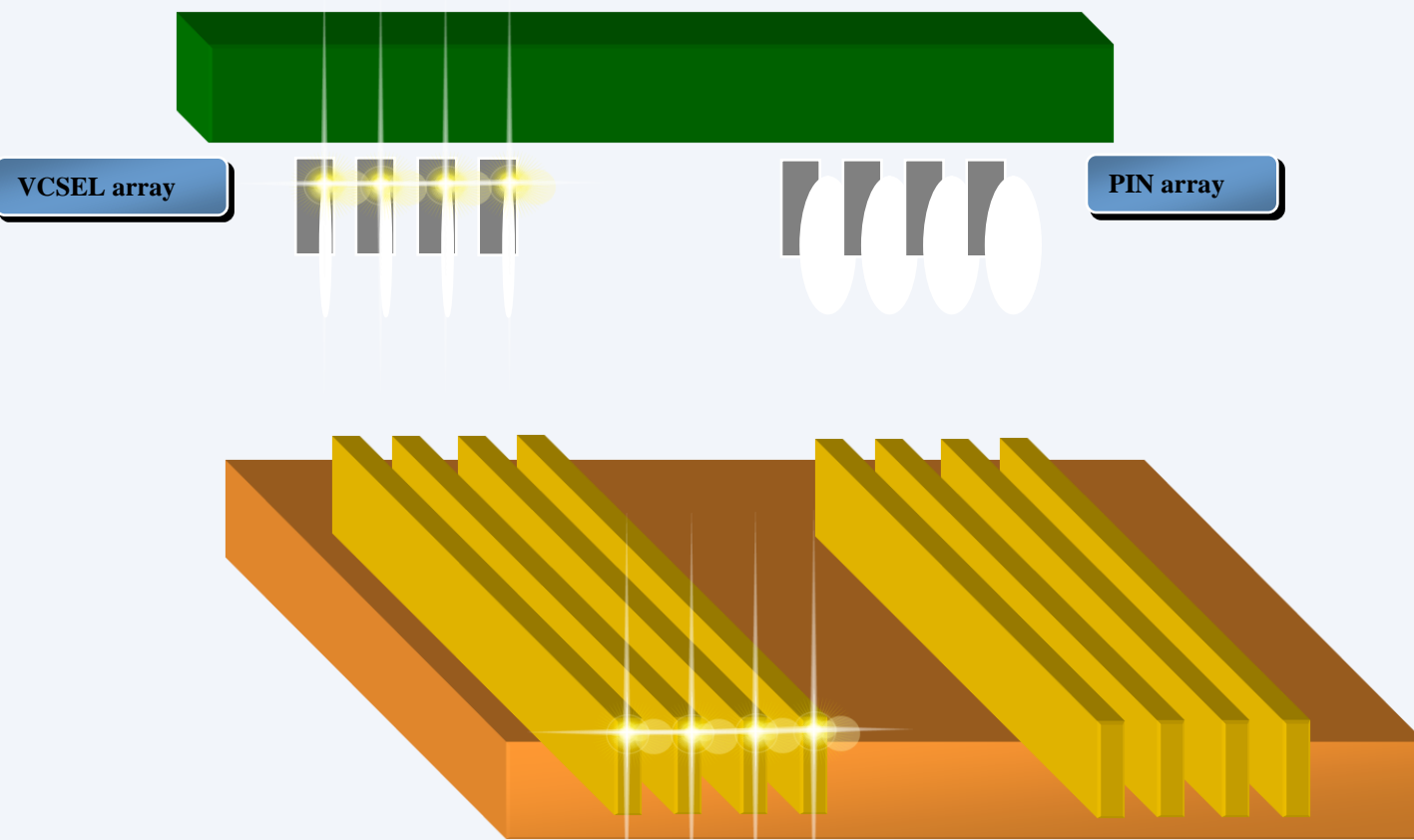

ELECTRO-OPTICAL BACKPLANE

Hybrid Electro-Optical Printed Circuit Board

- ❑ Standard Compact PCI backplane architecture
- ❑ 12 electrical layers for power and C-PCI signal bus and peripheral connections
- ❑ Electrical C-PCI connector slots for SBC and line cards
- ❑ 1 polymeric optical layer for high speed 10 GbE traffic
- ❑ 4 optical connector sites
- ❑ Dedicated point-to-point optical waveguide architecture

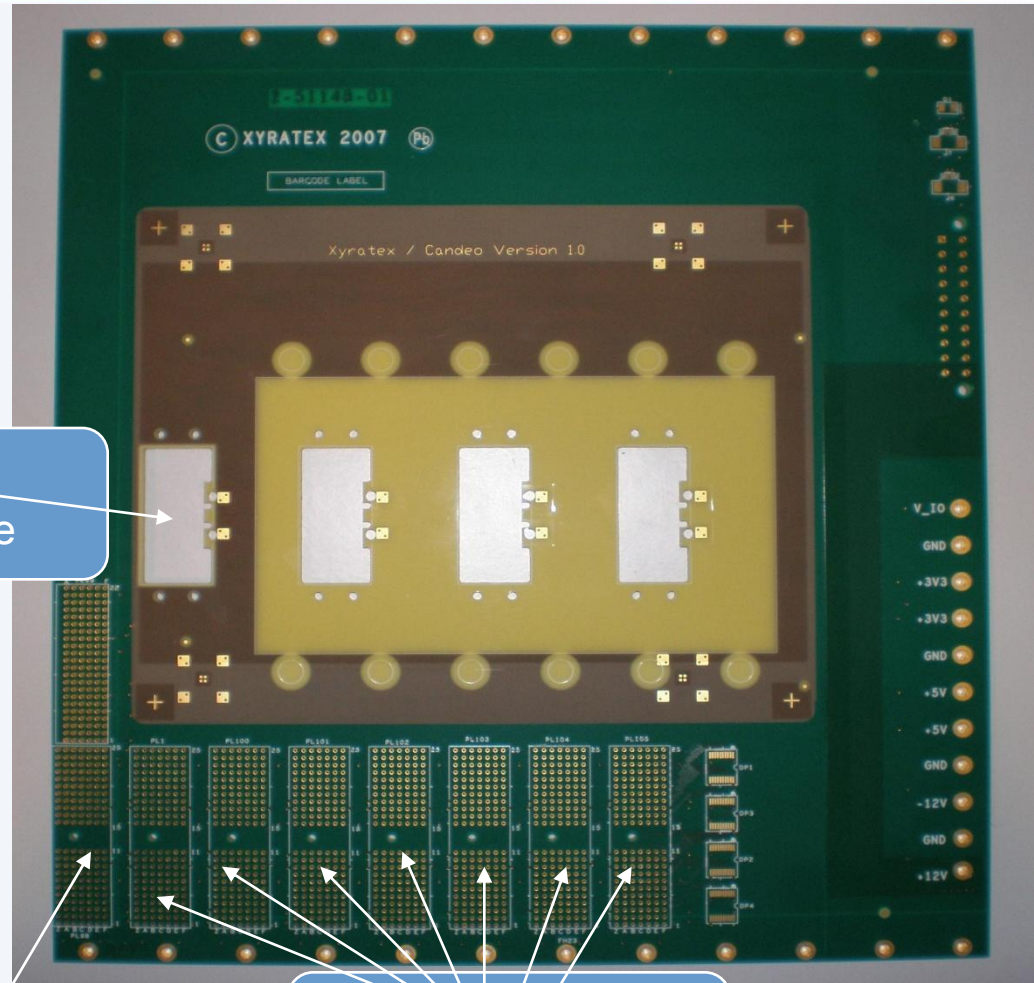

Optical connector site

Compact PCI slot for single board computer

Compact PCI slots for line cards

xyratex

ELECTRO-OPTICAL BACKPLANE

Hybrid Electro-Optical Printed Circuit Board

- ❑ Standard Compact PCI backplane architecture
- ❑ 12 electrical layers for power and C-PCI signal bus and peripheral connections
- ❑ Electrical C-PCI connector slots for SBC and line cards
- ❑ 1 polymeric optical layer for high speed 10 GbE traffic
- ❑ 4 optical connector sites
- ❑ Dedicated point-to-point optical waveguide architecture

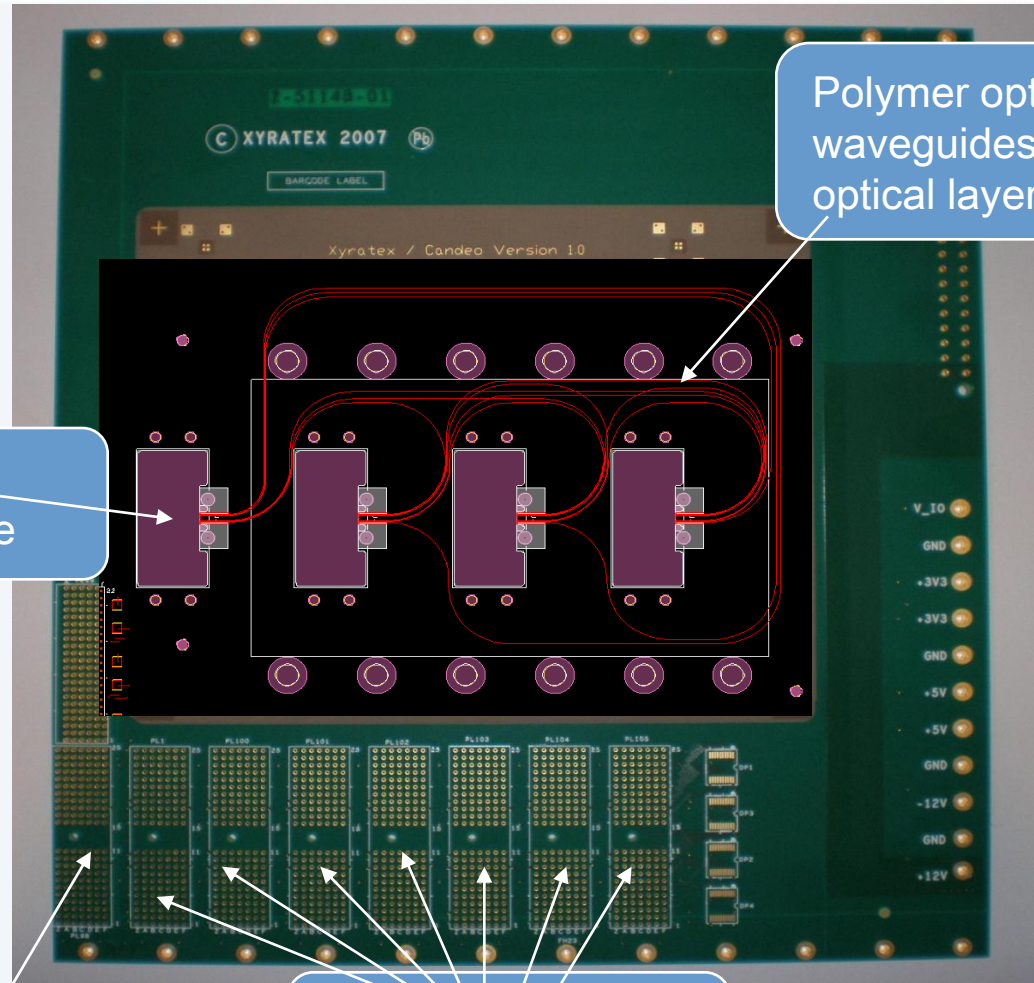

Optical connector site

Polymer optical waveguides on optical layer

Compact PCI slot for single board computer

Compact PCI slots for line cards

PARALLEL OPTICAL PCB CONNECTOR MODULE

Parallel optical transceiver circuit

- ❑ Small form factor quad parallel optical transceiver
- ❑ Microcontroller supporting I²C interface
- ❑ Samtec “SEARAY™” open pin field array connector
- ❑ Spring loaded platform for optical engagement mechanism
- ❑ Custom heatsink for photonic drivers

Spring loaded platform

Samtec field array connector

Microcontroller

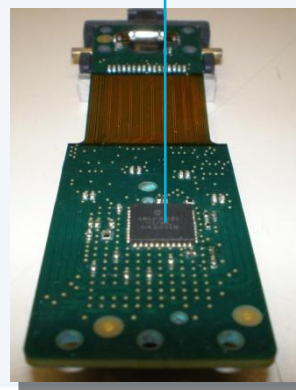
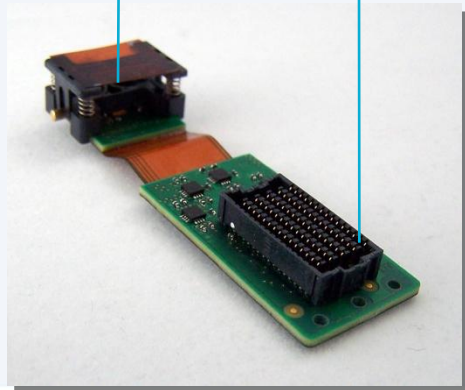

Backplane connector module

- ❑ Samtec / Xyratex collaborate to develop optical PCB connector
- ❑ 1 stage insertion engagement mechanism developed
- ❑ Xyratex transceiver integrated into connector module

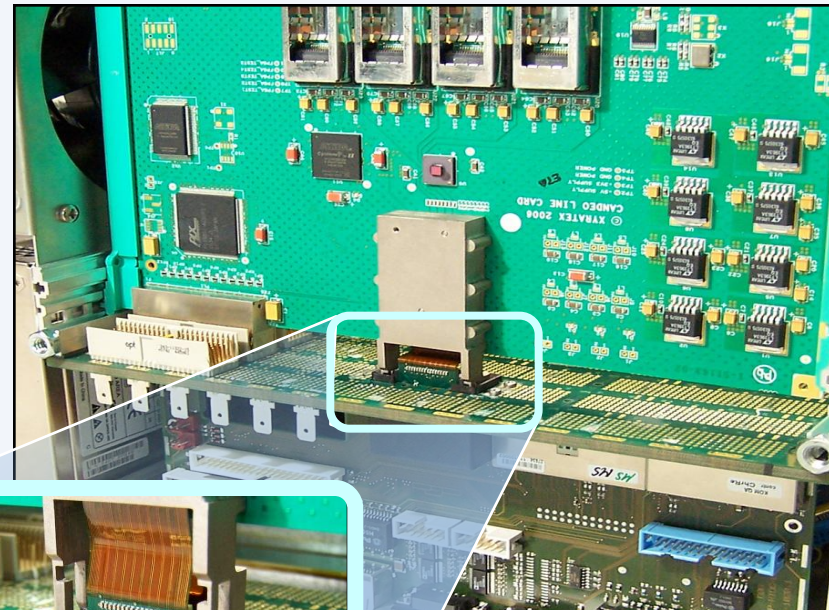

Engagement process

- ❑ Optical transceiver interface floats
- ❑ Backplane receptacle “funnels” connector
- ❑ Cam followers force optical interface up
- ❑ Optical transceiver lens butt-couples to

backplane lens

Undocked

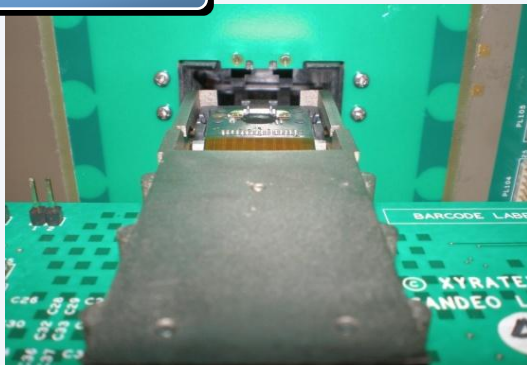

Docked



Cam followers

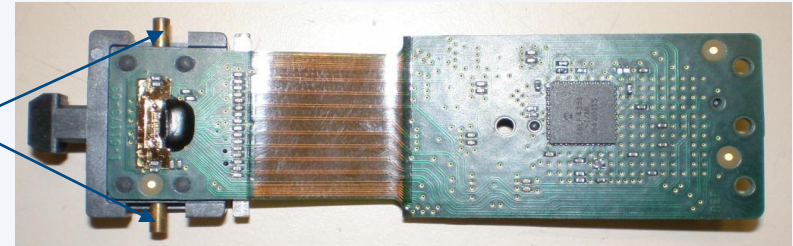

Cam track

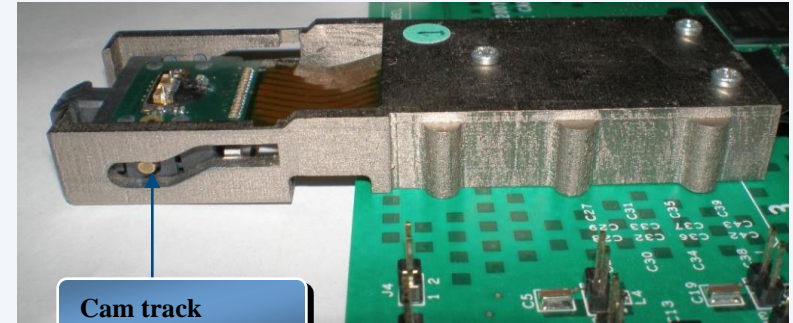

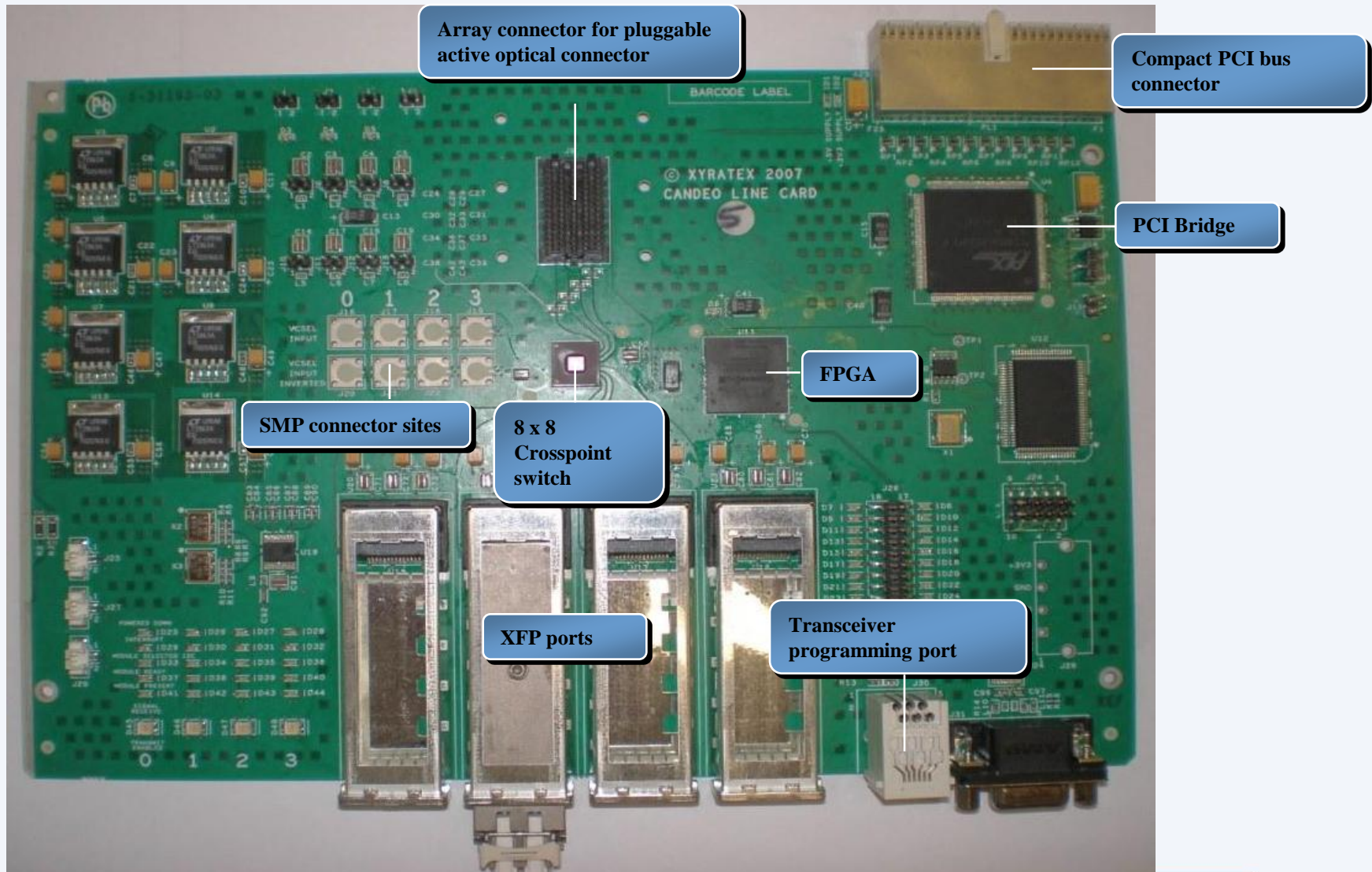

Demonstrator with Optical Interconnects

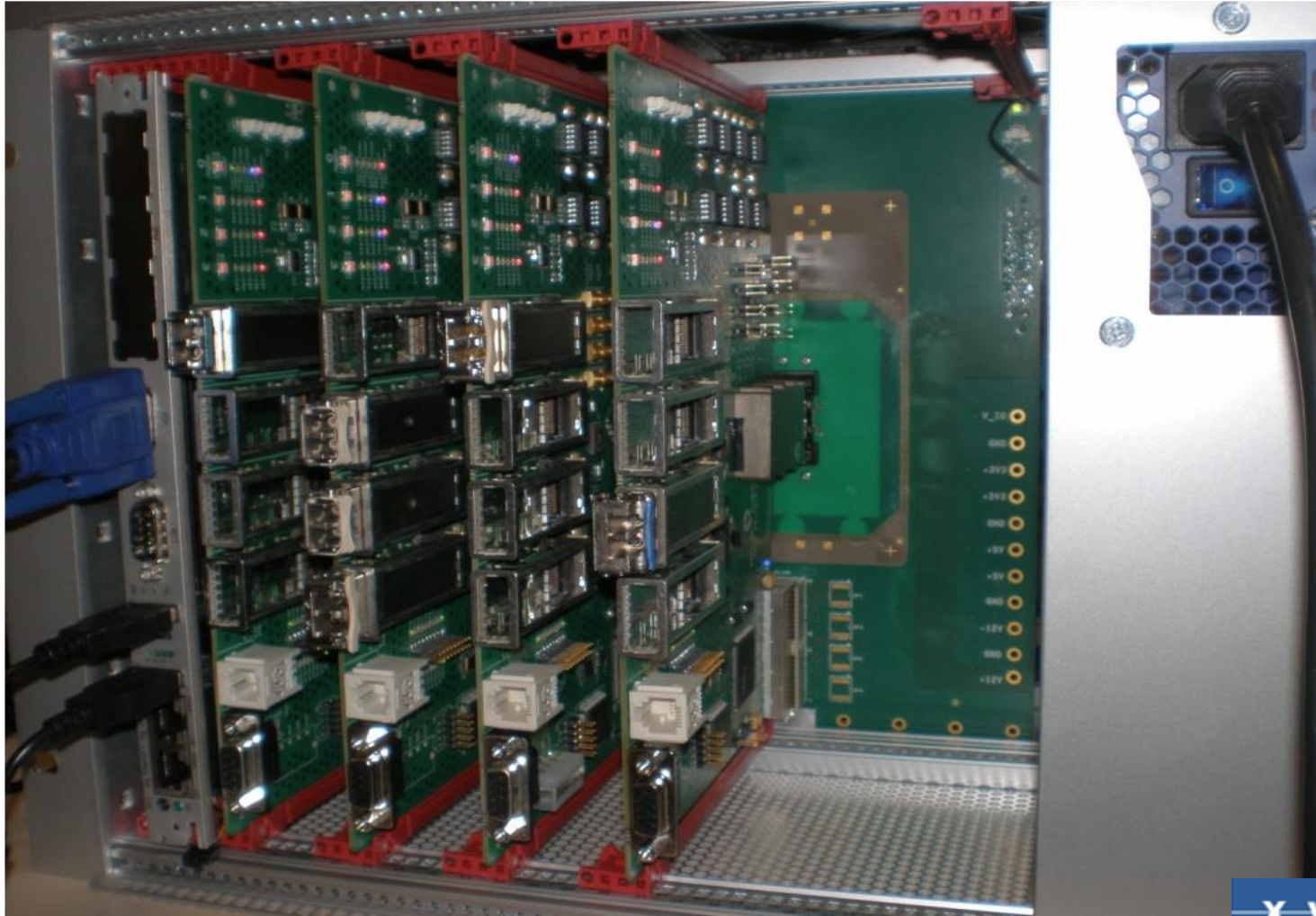

Electro-optical backplane

Pluggable optical backplane connectors

Compact PCI chassis

High speed switch line cards

XFP front end

Single board computer





Acknowledgments



- **University College London, UK**
 - Kai Wang, Hadi Baghsiahi, F. Aníbal Fernández, Ioannis Papakonstantinou (now at Sharp Labs of Europe Ltd)
- **Loughborough University, UK**
 - David A. Hutt, Paul P. Conway, John Chappell, Shefiu S. Zakariyah
- **Heriot Watt University**
 - Andy C. Walker, Aongus McCarthy, Himanshu Suyal
- **BAE Systems, UK**
 - Henry White
- **Stevenage Circuits Ltd. (SCL), UK**
 - Dougal Stewart, Jonathan Calver, Jeremy Rygate, Steve Payne
- **Xyratex Technology Ltd., UK**
 - Dave Milward, Richard Pitwon, Ken Hopkins
- **Exxelis Ltd**
 - Navin Suyal and Habib Rehman
- **Cadence**
 - Gary Hinde
- **EPSRC and all partner companies for funding**

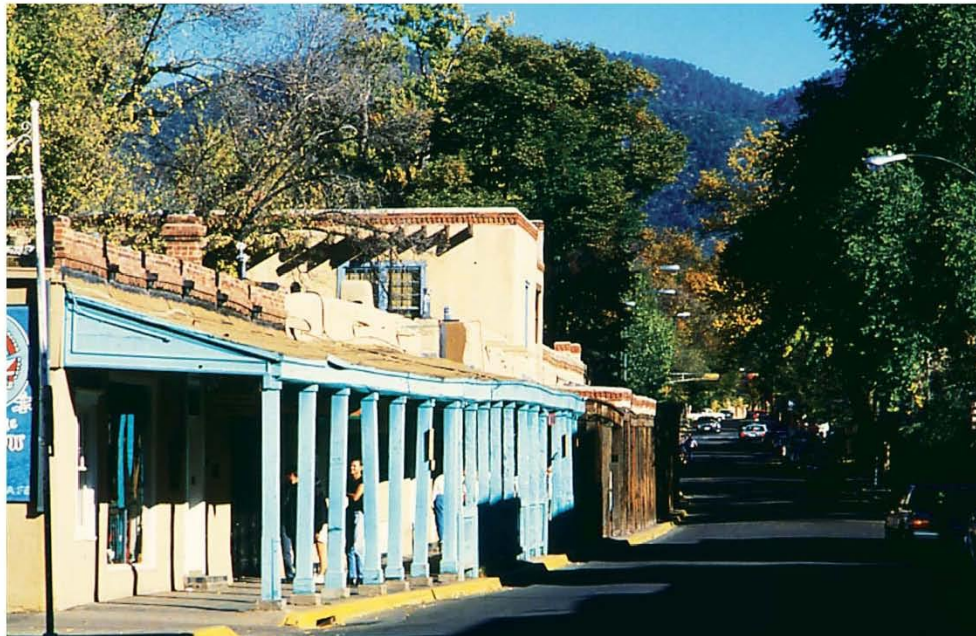

www.i-leos.org

Hilton Santa Fe Historic Plaza, Santa Fe, New Mexico

Photo: Jack Parsons

20th Annual Workshop on Interconnections Within High Speed Digital Systems

3-6 May 2009

*Sponsored by the IEEE Lasers & Electro-Optics Society
and in cooperation with the IEEE Computer Society*



REGISTRATION DEADLINE: 14 APRIL 2009