

Multi-parametric Linear Programming Under Global Uncertainty

Vassilis M. Charitopoulos, Lazaros G. Papageorgiou, and Vivek Dua 

Dept. of Chemical Engineering, Centre for Process Systems Engineering, University College London, Torrington Place, London WC1E 7JE, U.K.

DOI 10.1002/aic.15755

Published online in Wiley Online Library (wileyonlinelibrary.com)

Multi-parametric programming has proven to be an invaluable tool for optimisation under uncertainty. Despite the theoretical developments in this area, the ability to handle uncertain parameters on the left-hand side remains limited and as a result, hybrid, or approximate solution strategies have been proposed in the literature. In this work, a new algorithm is introduced for the exact solution of multi-parametric linear programming problems with simultaneous variations in the objective function's coefficients, the right-hand side and the left-hand side of the constraints. The proposed methodology is based on the analytical solution of the system of equations derived from the first order Karush–Kuhn–Tucker conditions for general linear programming problems using symbolic manipulation. Emphasis is given on the ability of the proposed methodology to handle efficiently the LHS uncertainty by computing exactly the corresponding nonconvex critical regions while numerical studies underline further the advantages of the proposed methodology, when compared to existing algorithms. © 2017 The Authors AICHE Journal published by Wiley Periodicals, Inc. on behalf of American Institute of Chemical Engineers AICHE J, 00: 000–000, 2017

Keywords: multi-parametric programming, left hand side uncertainty, linear programming, symbolic manipulation, uncertainty, Groebner bases

Introduction

Despite the constantly growing computational power decision makers have at hand, the need for systematic treatment of uncertainty has always been of paramount importance, especially under the ever-changing market conditions that the industries have to face. Uncertainty arises inevitably from the type of the models used to simulate the systems under examination; for example, variability in inputs and measurements, changes in the system's properties, fluctuations in prices, demand, availability of equipment, and so forth. Failing to take into consideration uncertainty can be crucial for the optimal operation of the system as the realisation of uncertainty can render an optimal solution or strategy into suboptimal or even infeasible. To deal with the presence of uncertainty, several methodologies such as stochastic programming, robust optimisation, fuzzy mathematical programming, chance constrained programming and so forth have been proposed throughout the years.¹ Within the stochastic programming framework,² the decision maker typically takes some actions before the realisation of uncertainty (here and now) while at subsequent steps (after the uncertainty has been revealed) takes corrective actions

to handle the uncertainty (resource/wait and see). Based on whether the uncertainty occurs in one step or multiple, that is, over a number of time periods, the stochastic program is referred to as either “two-stage stochastic” or “multi-stage stochastic,” respectively, and the cost of initial and recourse actions is minimised. The main assumption in stochastic programming is the availability of statistical data about the uncertain parameters providing either discrete or continuous probability distributions which the uncertain parameters follow. Another popular strategy to deal with uncertainty is robust optimisation^{3,4} which typically aims to make the underlying optimisation problem feasible in face of any possible realisation of the uncertain parameters. Robust optimisation, leads to more computationally tractable problems when compared to stochastic programming at the expense of generally more conservative solutions. Robust optimisation converts the original optimisation problem to its “robust-counterpart” and several methodologies have been proposed in the literature. Soyster⁵ initially proposed a worst-case formulation for linear programming problems but is considered to be too conservative as the resulting robust solution tends to overestimate the extend of uncertainty. Bertsimas and Sim⁶ proposed a more flexible formulation, while preserving the linear form of the problem, with the introduction of a “budget parameter” as a measure of conservatism. Based on their approach, any uncertain parameter can either be at its nominal or worst-case value but the total number of uncertain parameters that can take their worst value is controlled by the budget parameter. Another difference between stochastic programming and robust optimisation is that in the latter, the uncertainty is assumed to lie within a

Correspondence concerning this article should be addressed to V. Dua at v.dua@ucl.ac.uk.

This is an open access article under the terms of the Creative Commons Attribution License, which permits use, distribution and reproduction in any medium, provided the original work is properly cited.

© 2017 The Authors AICHE Journal published by Wiley Periodicals, Inc. on behalf of American Institute of Chemical Engineers

prespecified set, the so called “uncertainty-set,” and no information about probabilistic distributions is required.⁴

Apart from the aforementioned methodologies, sensitivity analysis, and multi-parametric programming (mp-P) form also two popular alternatives to study how optimal solutions depend on uncertain parameters. Despite the fact that both approaches make use of information derived by a postoptimal analysis, sensitivity analysis differs from parametric programming on the range of the uncertainty as it provides information about the effect on the optimal solution only around a specific neighborhood of the uncertain parameters. On the contrary, multi-parametric programming offers the unique advantage of explicitly providing information about the dependence of the optimal solution on the uncertain parameters throughout the entire range of variability without the need of exhaustive enumeration.^{7–9} The general notion of mp-P can be summarised as follows: given an optimisation problem with uncertain parameters compute the optimal solutions as explicit functions of the parameters together with the regions of the parametric space, also known as critical regions (CRs), where each solution remains optimal; this way the need for repetitive solution of the optimisation problem, whenever uncertainty occurs, is replaced by simple and computationally efficient function evaluations based on a precomputed “multi-parametric map”. Mathematically this can be expressed by the following general mp-P for the linear cases:

General mp-P

$$z(\theta) = \min_{\mathbf{x}, \mathbf{y}} \mathbf{c}^T(\theta)\mathbf{x} + \mathbf{d}^T(\theta)\mathbf{y}$$

$$\text{Subject to : } \mathbf{A}(\theta)\mathbf{x} + \mathbf{W}(\theta)\mathbf{y} \leq \mathbf{b} + \mathbf{F}(\theta)$$

$$\mathbf{x} \in X \triangleq \{\mathbf{x} \in \mathbb{R}^{n_x} \mid x_k^{\min} \leq x_k \leq x_k^{\max}, k=1, \dots, n_x\} \quad (1)$$

$$\mathbf{y} \in \{0, 1\}^{n_y}$$

$$\theta \in \Theta \triangleq \{\theta \in \mathbb{R}^{n_\theta} \mid \theta_l^{\min} \leq \theta_l \leq \theta_l^{\max}, l=1, \dots, n_\theta\}$$

where θ denotes the vector of uncertain parameters and belongs to the bounded set Θ , \mathbf{x} is the vector optimisation variables and belongs to the bounded set X , $\mathbf{c} \in \mathbb{R}^{n_x}$, $\mathbf{d} \in \mathbb{R}^{n_y}$, $\mathbf{A}(\theta) \in \mathbb{R}^{m \times n_x}$, $\mathbf{W}(\theta) \in \mathbb{R}^{m \times n_y}$, $\mathbf{b} \in \mathbb{R}^m$, $\mathbf{F} \in \mathbb{R}^{m \times n_\theta}$ are vector and matrices of appropriate dimensions. Problem (1), refers to the general class of linear mp-P problems where the optimisation variables are continuous and integer. According to the nature of the functions of the original optimisation problem different strategies can be used to compute the optimal parametric solutions and the corresponding CRs; in Table 3

Table 1. Abbreviations Index

OFC	Objective function's coefficient
RHS	Right-hand side
LHS	Left-hand side
mp-P	Multi-parametric programming
CR	Critical region
mp-LP	Multi-parametric linear programming
mp-QP	Multi-parametric quadratic programming
mp-NLP	Multi-parametric nonlinear programming
mp-MILP	Multi-parametric mixed integer linear programming
mp-MIQP	Multi-parametric mixed integer quadratic programming
mp-MINLP	Multi-parametric mixed integer nonlinear programming
RIM-mp-LP	Multi-parametric linear programming with OFC and RHS uncertainty
CAD	Cylindrical algebraic decomposition

Table 2. Nomenclature

Indices	
k	Optimisation variables
l	Uncertain parameters
j	Inequality constraints
Sets	
X	Set of continuous optimisation variables
Θ	Set of uncertain parameters
Symbols	
$\text{adj}(\cdot)$	Adjugate of a square matrix
$\text{det}(\cdot)$	Determinant of a square matrix
$\text{length}(\cdot)$	Operator that returns the length of a list-object
LIST	List of candidate solutions
Parameters	
n_x	Dimensionality of optimisation variables
n_θ	Dimensionality of uncertain parameters
m	Dimensionality inequality constraints
θ	Uncertain parameters
$c(\theta)$	Perturbed objective function's coefficients
$\mathbf{A}(\theta)$	Perturbed constraint matrix
$\mathbf{F}(\theta)$	Right-hand side matrix of perturbations
Decision variables	
$z(\theta)$	Explicit expression of objective value
$\mathbf{x}(\theta)$	Explicit expression of continuous variables
$\lambda(\theta)$	Explicit expression of lagrange multipliers

summary of multi-parametric programming algorithms is presented.

For the case of (multi-)parametric linear programming (mp-LP) problems, extended research work can be found in the literature that has treated systematically RHS-OFC uncertainty (see Table 1 for Abbreviations and Table 2 for Nomenclature). Early on after Dantzig presented the Simplex algorithm for the solution of LPs, Gass and Saaty^{10–12} in 1954 and 1955 presented their works on parametric programming for perturbations in the OFC. Later,¹² they generalised their approach for n -parametric perturbations in the OFC and proved that the CRs of such case are convex. Gal and Nedoma,¹³ in their seminal paper, presented for the first time a systematic way for the treatment of mp-LPs with OFC and/or RHS uncertainty based on the simplex method and finding the associated parametric optimal basis. In Gal,¹⁴ a method for simultaneous variations in the OFC and RHS (also known as “RIM”) of the constraint matrix was proposed and the resulting problem is an RIM-mp-LP. Yu and Zeleny,¹⁵ based on advances from the multicriteria simplex method, presented two algorithms for the solution of mp-LPs. The first one was an indirect algebraic method which locates the set of nondominated extreme points while the second one was a direct geometric decomposition method. An alternative procedure for mp-LPs with RHS uncertainty can be found in Schechter¹⁶ where the author dualises the LP and then enumerates all the extreme points of the dual so as to compute the “irredundant” piecewise representation of $z(\theta)$ and the corresponding CRs. Almost 20 years later, Borelli et al.¹⁷ presented a geometric based algorithm for mp-LPs with RHS uncertainty, where rather than examining different optimal bases of the mp-LP, a direct exploration of the parametric space is used and this way

Table 3. Overview of mp-P Algorithms

mp-LP	13,15–18
mp-QP	39–41
mp-NLP	42–47
mp-MILP	23,24,38,48–52
mp-MIQP	53,54
mp-MINLP	29,55–57

degenerate mp-LPs can be handled efficiently. Another approach for the approximate solution of mp-LPs with RHS uncertainty can be found in Fillipi.¹⁸ Jones and Morari¹⁹ proposed an algorithm for multi-parametric linear complementary problems, for the case that parameters appear linearly in the objective function and the RHS of the constraints. In their approach, lexicographic perturbation was used to handle degeneracy in mp-LPs while the exploration of the parametric space is done along the geometric lines. In general, all the aforementioned algorithms are closely related to the simplex method for the solution of the original LPs and their common denominator is the search for “optimal basis invariance” through one way or another. Interior point (IP) algorithms have attracted a significant amount of interest from researchers for the solution of LPs and as a result new theoretical advances emerged. For mp-LPs, IP based algorithms do not seek for “optimal basis invariance” but “support set invariance” and “optimal partition invariance.”^{20,21} A thorough introduction to multi-parametric linear programming and the issues arising from degeneracy is presented in the excellent book of Gal.²²

Despite the aforementioned research work in the field of mp-P, the case of mp-P problems with LHS uncertainty has received so far limited attention mainly because of the computational complexity of the resulting optimisation problem; this is because of the nonconvex terms that arise between the uncertain entries of the technology matrix and the optimisation variables, while solving the underlying parametric optimisation problem. A simplex based algorithm for the case of single parameter perturbations in one column or one row of the technology matrix can be found in Gal.²² Li and Ierapetritou²³ proposed a methodology for the solution of the general mp-MILPs with simultaneous LHS, RHS, and OFC uncertainty. When LHS uncertainty was considered, the authors used discretisation of the parametric space and projection algorithms. The underlying mp-LP algorithm was solved based on the optimality conditions of LP and identifying basic and nonbasic variables at every instance of the parametric space. Finally, in order to examine if they had covered the original (generally) nonconvex CR, evenly distributed points from the parametric space were sampled to check the validity of the results; it can be understood that results from this framework are heavily influenced from the level of discretisation of the parametric space as well as the choice of the projection algorithm and cannot guarantee the validity of the resulting explicit solutions. A framework for the global solutions of the general mp-MILPs, within prespecified tolerance of ϵ -optimality, was presented by Wittmann-Hohlbein and Pistikopoulos²⁴ within which the authors considered also LHS uncertainty. The authors exploited the structure of the mp-LP with LHS uncertainty subproblem, where they identified the bilinear terms from the multiplication of the uncertain parameters with the optimisation variables and used McCormick relaxations to transform the LHS into approximate RHS uncertainty. Their approach included a spatial branch and bound routine on the optimisation variables and the uncertain parameters. As noted by the authors, the quality of the results by implementing this algorithm, is depended on the partitioning scheme for the uncertain parameters but that results in higher computational times and number of CRs examined. This approach does not provide the exact solution for the case of LHS uncertainty. The same authors²⁵ proposed a two-stage approach to handle the global uncertainty in mp-MILPs in which the conventional “worst case” robust counterpart was used for the LHS uncertainty while the resulting partially robust mp-MILP was then solved in a decomposed

fashion through iterations between master MINLPs (solved to global optimality) and slave mp-LPs. Recently,²⁶ an algorithm for the systematic treatment of LHS single-parameter uncertainty in LPs was presented. The authors identified that the problem includes at its core the inversion of parametric matrices and the computational complexities arising by this fact. To handle this issue, a two stage algorithm was devised that uses the Flavell-Salkin²⁷ approximate method to find the location of breakpoints in the parametric intervals and the Woodbury formula²⁸ for the correctness of the result.

In this work, motivated by the continuously increasing demand for efficient and effective decision making we propose an algorithm for the explicit solution of general mp-LPs when global uncertainty is considered. The idea of the proposed algorithm is two-fold: at first the Karush–Kuhn–Tucker (KKT) system of the original LP problem is formulated and solved analytically using Groebner Bases theory within a computational environment that allows symbolic manipulations, resulting in the complete map of candidate solutions (including infeasible, local, and global parametric optima); next, the optimality and feasibility conditions are used so as to evaluate the candidate solutions and a comparison procedure is followed so as to keep only the global parametric optimal solutions of the problem. A salient feature of the proposed algorithm is its ability to compute the exact globally optimal parametric solutions together with the corresponding nonconvex CRs.

The remainder of the article is organised as follows: in Methodology section, the proposed general framework for global uncertainty in mp-LPs is introduced along with two theorems for the characterisation of the explicit solutions and the critical regions. In the Case Studies section, we illustrate the applicability of the proposed algorithm through a number of case studies together with comparison of already proposed methodologies. In the Discussion section, based on the case studies examined a short discussion is conducted on topics related to the computational behavior of the proposed algorithm. Finally, in the last section of the article, the main contributions of this work are summarised and future research directions are drawn.

Methodology

Global uncertainty in general mp-LPs

The main idea of the proposed algorithm is to use the KKT optimality conditions so as to create a square system of equations and solve this system analytically using symbolic manipulation software and computer algebra principles. At the core of the proposed algorithm, Groebner Bases theory is found because of its ability to solve systems of simultaneous equations analytically as shown in our latest work.²⁹

Consider the general mp-LP problem with uncertain entries on the OFC, the LHS and the RHS of the constraints, that is, global uncertainty, given by (2)

$$\text{mp-LP}_{\text{global}} \begin{cases} z(\theta) = \min_{\mathbf{x}} \mathbf{c}^T(\theta)\mathbf{x} \\ \text{subject to:} & \mathbf{A}(\theta)\mathbf{x} \leq \mathbf{b} + \mathbf{F}(\theta) \\ \mathbf{x} \in \mathbf{X} \triangleq \{\mathbf{x} \in \mathbb{R}^{n_x} \mid x_k^{\min} \leq x_k \leq x_k^{\max}, k=1, \dots, n_x\} \\ \theta \in \Theta \triangleq \{\theta \in \mathbb{R}^{n_\theta} \mid \theta_l^{\min} \leq \theta_l \leq \theta_l^{\max}, l=1, \dots, n_\theta\} \end{cases} \quad (2)$$

The solution of problem (2), over the parametric range specified by the set Θ , provides the optimisers, that is, $\mathbf{x}(\theta) = \arg$

$\min_{\mathbf{x}} \mathbf{c}^T(\boldsymbol{\theta})\mathbf{x}$ and the optimal value, that is, $z(\boldsymbol{\theta})$, as explicit functions of the uncertain parameters along with the corresponding CRs where each solution remains optimal.

The first-order KKT conditions for problem (2) are formulated as follows

$$(P_1) \begin{cases} \nabla_{\mathbf{x}} L(\mathbf{x}, \boldsymbol{\theta}) = 0 \\ \lambda_j \left(\sum_{k=1}^{n_x} a_{j,k}(\boldsymbol{\theta}) x_k - b_j - \sum_{l=1}^{n_\theta} f_{j,l}(\boldsymbol{\theta}) \right) = 0, \forall j=1, \dots, m \end{cases}$$

where $L(\mathbf{x}, \boldsymbol{\theta}) = \mathbf{c}^T(\boldsymbol{\theta})\mathbf{x} + \sum_{j=1}^m \lambda_j \left(\sum_{k=1}^{n_x} a_{j,k}(\boldsymbol{\theta}) x_k - b_j - \sum_{l=1}^{n_\theta} f_{j,l}(\boldsymbol{\theta}) \right)$ is the Lagrange function of problem (2). The total number of equation is given by: no. of equations = $n_x + m$, which is sufficient to compute analytically the Lagrange multipliers and the optimisation variables in terms of the uncertain parameters $\boldsymbol{\theta}$, using Groebner Bases theory. Solving the system of equations analytically, we compute the optimisation variables ($\mathbf{x}(\boldsymbol{\theta})$) and the Lagrange multipliers ($\boldsymbol{\lambda}(\boldsymbol{\theta})$) as functions of the problem's uncertain parameters, that is, $\boldsymbol{\theta}$. Substituting the explicit functions back in the inequality constraints given by Eq. 3 and 4 the feasibility and optimality of the candidate solutions is evaluated. Note that Eq. 3 refers to the non-negativity of the Lagrange multipliers, which are now parametric in $\boldsymbol{\theta}$. Equation 4 refers to the negativity of the inequality constraints, $g(\cdot)$, which after the substitution of the explicit expression of the optimisers ($\mathbf{x}(\boldsymbol{\theta})$) are now parametric inequalities.

$$\lambda_j(\boldsymbol{\theta}) \geq 0, j=1, \dots, m \Rightarrow \text{optimality conditions} \quad (3)$$

$$g_j(\boldsymbol{\theta}) \leq 0, j=1, \dots, m \Rightarrow \text{feasibility conditions} \quad (4)$$

DEFINITION. (Candidate solution of mp-LP global) *Within the context of this work, a solution of problem (2) is said to be candidate if it satisfies the system of equations given by (P₁). Note that the candidate solutions are composed of the optimisers ($\mathbf{x}(\boldsymbol{\theta})$) and the Lagrange multipliers ($\boldsymbol{\lambda}(\boldsymbol{\theta})$) which are explicit functions of the uncertain parameters. Some of the candidate solutions may be infeasible if the conditions (3) or (4) are violated $\forall \boldsymbol{\theta} \in \Theta$ and global/local parametric optima for some $\boldsymbol{\theta} \in \Theta$ otherwise.*

Substituting a candidate solution into Eqs. 3 and 4, results in a set of parametric inequality constraints that form the Critical Region (CR) of the candidate feasible solution.

DEFINITION. (Critical region of mp-LP under global uncertainty) *In the context of this work and given the nature of the problem and the symbolic character of the proposed algorithm, we consider as CRs the regions of the parametric space where conditions (3) and (4) are satisfied for a specific candidate solution. A CR is defined uniquely by a specific set of active/inactive constraints and may not be continuous.*

After the final feasible explicit solutions are computed along with their corresponding CRs, because of the nonconvex nature of the parametric problem under study, there might be some CRs that share the same part of the parametric space (overlapping CRs). To provide at the end the globally optimal explicit set of solutions, that is, explicit solutions that do not overlap, a comparison procedure has to be followed. The main challenge, is that the CRs involved are in general nonconvex and can be discontinuous as well. From a computational point of view, the tool employed within the comparison procedure is Cylindrical Algebraic Decomposition (CAD). Briefly, the main steps of the comparison procedure include the identification of the common

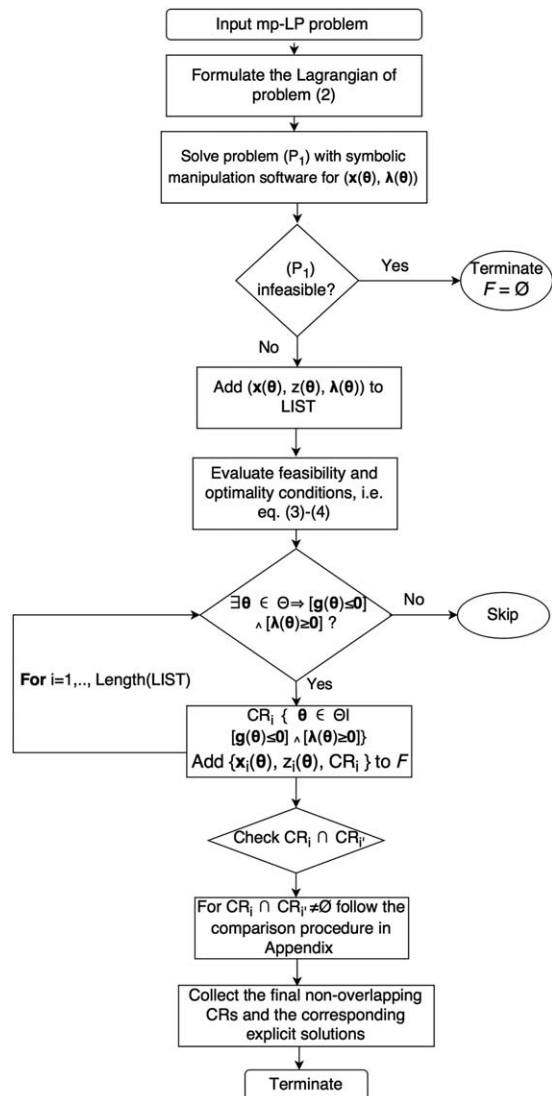

Figure 1. Outline of the proposed algorithm for mp-LP under global uncertainty.

overlap of the corresponding CRs. After the overlap is identified, the explicit solution which is dominant is kept, while from the other one the corresponding region of parametric space is removed. The comparison procedure along with the computational steps are discussed in greater detail in Appendix.

REMARK. *Another major difficulty in the global solution of general mp-LPs arises from the ability to invert parametric matrices when LHS uncertainty is considered.²⁶ This difficulty, is because typically for the solution of general mp-LPs, one would have to solve, at least for initialisation, an NLP (with the uncertain parameters treated as free variables, thus resulting in bilinear terms), locate a feasible point, perform the required sensitivity calculations and then perturb until the entire parametric space is covered. In this work, we do not visit the optimal parametric bases; on the contrary, we solve the problem analytically and the entire parametric space is explored implicitly through the proposed algorithm and thus we do not have to perform inversion of parametric matrices. Because of that we alleviate the corresponding computational burden that would otherwise be prohibitive for the application on large scale problems.*

Algorithm 1. Algorithm for global mp-LPs

```

Input:    mp-LP problem
Output:    $\mathcal{F}$ 
1:        $(x(\theta), \lambda(\theta), z(\theta)) \leftarrow (\text{void}, \text{void}, \infty)$ 
2:       LIST  $\leftarrow \emptyset$ 
3:       Formulate the Lagrangian of problem (2)
4:       Solve problem  $(P_1)$  using symbolic manipulation software for  $(x(\theta), z(\theta), \lambda(\theta))$ 
5:       if problem  $(P_1)$  is infeasible then :
6:          $\mathcal{F} = \emptyset$ 
7:       else :
8:         Add  $(x(\theta), z(\theta), \lambda(\theta))$  to LIST
9:         while  $\kappa \leq \text{length}(\text{LIST})$  do :
10:        for  $j=1, m$  :
11:          Substitute  $x_\kappa(\theta), \lambda_\kappa(\theta)$  in inequalities (3)–(4)
12:          if inequalities (3)–(4) are violated  $\forall \theta \in \Theta$  :
13:             $\text{CR}_\kappa \triangleq \emptyset$  and  $(x_\kappa(\theta), \lambda_\kappa(\theta))$  is infeasible solution
14:          else  $\text{CR}_\kappa \triangleq \{\theta \in \Theta \mid \lambda_{\kappa,j}(\theta) \geq 0 \wedge g_j(x_\kappa(\theta)) \leq 0\}$ 
15:            Add element  $(x_\kappa(\theta), z_\kappa(\theta), \text{CR}_\kappa)$  to  $\mathcal{F}$ 
16:          end if
17:        end for
18:      end while
19:      for each  $\text{CR}_\kappa$  check  $\text{CR}_\kappa \cap \text{CR}_{\kappa'} :$ 
20:        if  $\text{CR}_\kappa^\omega \cap \text{CR}_{\kappa'(\kappa' \neq \kappa)}^\omega \neq \emptyset$  then :
21:          Perform dominance criterion according to Appendix A
22:        end if
23:      end for
24:    end if
25:    return  $\mathcal{F}$ 

```

In Algorithm (3), the main steps of the proposed methodology are described. While in Figure 1, the outline of the algorithm is given.

In Algorithm 1, steps (1)–(6) account for the formulation of the problem, where an empty LIST is initiated for the storage of the candidate solutions that result from the step (4) of the algorithm. In the case that the problem is not infeasible, that is, step (7), the candidate solutions are added to the LIST. As mentioned earlier in the manuscript, each candidate solution corresponds to a triplet $\{x(\theta), z(\theta), \lambda(\theta)\}$ and so, the LIST will have a length equal to the number of candidate solutions computed from step (4) based on the Groebner Bases calculations. At steps (9)–(18), the first major loop of the algorithm initiates for each of the candidate solutions where the corresponding CAD is computed based on the primal and dual feasibility conditions; if the CAD is empty, that is, there is no $\theta \in \Theta$ such that the primal and dual feasibility conditions are met, the corresponding CR of the candidate solution is empty [steps (12) and (13)] and candidate solution is removed from further consideration; otherwise, the CAD provides the mathematical expression of the CR where the candidate solution is feasible [steps (14) and (15)]. Once the CRs for the remaining candidate feasible solutions have been computed, the second loop of the algorithm begins where overlapping CRs are identified [step (19)] and the comparison procedure as explained in Appendix is followed; note that again this step involves CAD calculations. The algorithm finally terminates and returns the final list of explicit solutions along with the corresponding CRs, that is, \mathcal{F} .

THEOREM 1. (Optimal explicit solution of global mp-LP) Let θ be a vector of uncertain parameters and $A(\theta) = A_{\text{nom}} + A_*\theta$ be affine mappings with respect to θ , where A_{nom} is the nominal part of the constraint matrix. Let also strict complementary slackness hold for each value of theta. When global uncertainty is considered in multi-parametric linear programming problems; the optimisers $(x(\theta))$ and the Lagrange multipliers $(\lambda(\theta))$, are piecewise fractional polynomial functions of the uncertain parameters, that is, θ .

Proof. The Lagrangian and its gradient for problem (2) are given in (5) and (6)

$$\mathcal{L} = c^T(\theta) \mathbf{x} + \sum_{i=1}^m \lambda_i (A_i(\theta) \mathbf{x} - b_i - F_i(\theta)) \quad (5)$$

$$\nabla_{\mathbf{x}} \mathcal{L} = c^T(\theta) + \sum_{i=1}^m \lambda_i A_i(\theta) = c^T(\theta) + \lambda^T A(\theta) \quad (6)$$

where $\lambda_i, A_i(\theta), b_i, F_i(\theta)$ correspond to the elements associated with the i th row of problem (2) and $\nabla_{\mathbf{x}}$ is the Nabla operator in the vector of optimisation variables. Because problem (2) is linear, the gradient of the Lagrange function with respect to the optimisation variables is an expression explicit in λ and θ , that is, $\nabla_{\mathbf{x}} \mathcal{L} = f(\lambda, \theta)$. The first-order KKT conditions for problem (2) are as follows

$$\nabla_{\mathbf{x}} \mathcal{L} = c^T(\theta) + \lambda^T A(\theta) = 0 \quad (7)$$

$$\lambda_i (A_i(\theta) \mathbf{x} - b_i - F_i(\theta)) = 0, \forall i = 1, \dots, m \quad (8)$$

Let $\check{\lambda}, \check{A}(\theta), \check{\mathbf{b}}, \check{F}$ denote the Lagrange multipliers, technology matrix, RHS elements respectively corresponding to active constraints, that is, the constraints for which the corresponding Lagrange multipliers are non-zero, based on the strict complementary slackness assumption.

For active constraints eq. 7 becomes

$$\mathbf{c}^T(\theta) + \check{\lambda}^T \check{A}(\theta) = 0 \quad (9)$$

Note that for the case of active constraints, $\check{A}(\theta)$ is a square matrix of n_x dimension and thus can be inverted under the assumption that the determinant of the matrix is non-zero. To this end, assume that there exist θ such that the determinant is non-zero and therefore $\check{A}(\theta)$ is invertible. Using the Cramer's rule³⁰ the inverse of the parametric matrix can be expressed as follows

$$\check{A}^{-1}(\theta) = \frac{\text{adj}(\check{A}(\theta))}{\det(\check{A}(\theta))} \quad (10)$$

where $\text{adj}(\cdot)$ and $\det(\cdot)$ denote the adjugate and the determinant of a matrix, respectively.

Solving Eq. 9 and using Cramer's rule, that is, Eq. 10, for $\check{\lambda}$ we get

$$\check{\lambda}_i = -c_i(\theta) \frac{\det(\check{A}_i(\theta))}{\det(\check{A}(\theta))} \quad (11)$$

which proves that the $\lambda(\theta)$ is a fractional polynomial function of θ . The continuity of $\lambda(\theta)$ will be commented on in Theorem 2.

Notice that in the above formula the term $\det(\check{A}_i(\theta))$ refers to the determinant of the A matrix if we substitute the i th column with the RHS of the corresponding equation [Eq. 9] which in our case is: $-\mathbf{c}^T(\theta)$. ■

COROLLARY. *The expressions of both the numerator and the denominator in Eq. 11 are polynomial in $a_{ij}(\theta)$,*

$i, j = 1, \dots, m$, where $a_{ij}(\theta)$ are the perturbed elements of the corresponding matrices. It follows that the fraction of two polynomials results in a fractional polynomial function.

From Eq. 8 and because of the assumption for strict complementary slackness for the active constraints

$$\begin{aligned} \check{A}(\theta)\mathbf{x} - \check{\mathbf{b}} - \check{F}(\theta) &= 0 \rightarrow \mathbf{x} = \check{A}^{-1}(\theta)(\check{\mathbf{b}} + \check{F}(\theta)) \\ \rightarrow x_i(\theta) &= (\check{b}_i + \check{F}_i(\theta)) \frac{\det(A_i(\theta))}{\det(\check{A}(\theta))} \end{aligned} \quad (12)$$

which proves that the optimiser $\mathbf{x}(\theta)$ is a fractional polynomial function of θ . ■

REMARK. *Within the proof of the theorem an assumption about the invertibility of the $A(\theta)$ matrix was made. For the inverse to exist, $\det(A(\theta)) \neq 0$ which practically means excluding roots of the polynomial obtained by requiring $\det(A(\theta)) = 0$.*

Before moving on to Theorem 2 it is important to provide the definition of "semi-algebraic sets."

DEFINITION. (Semi-Algebraic Sets)³¹ *Let $\mathbb{R}[X]$ denote the ring of polynomials in n_x indeterminates with real coefficients. A subset S of \mathbb{R}^{n_x} is called semi-algebraic if it can be constructed by finitely many applications of the union, intersection and complementation operations, starting from sets of the form*

$$\{\mathbf{x} \in \mathbb{R}^{n_x} \mid \mathbf{g}(\mathbf{x}) \leq 0\}, \text{ where } \mathbf{g} \in \mathbb{R}[X]$$

Alternatively, it can be said that a semi-algebraic set of \mathbb{R}^{n_x} is defined by Boolean operations (conjunctions, disjunctions, and negations) of conditional expressions involving a finite number of polynomials.

REMARK. In this work, we consider semi-algebraic sets as a generalisation of the an arbitrary set defined by a number of equations/inequalities. Notice, that for the special case that the functions $\mathbf{g}(\mathbf{x})$ are linear the aforementioned

Table 4. Candidate Solutions of Example 1

No. of Candidate Solution	x_1	x_2	x_3	x_4	λ_1	λ_2	λ_3	λ_4	λ_5	λ_6
1	0	5	-2	0	17	-5	$-8-27\theta$	0	0	-15
2	0	0	$\frac{21}{2}$	$\frac{5}{2}$	2	$\frac{5}{2}$	$\frac{(6\theta-1)}{2}$	15	0	0
3	0	$\frac{21}{5}$	0	$\frac{5}{2}$	$\frac{1}{2}$	$\frac{5}{2}$	$\frac{(9\theta-4)}{2}$	0	-3	0
4	$\frac{21}{1-\theta}$	0	0	$\frac{89\theta+16}{21\theta+4}$	$\frac{5(2\theta-1)}{2(\theta-1)}$	$\frac{5}{2}$	0	$\frac{5(9\theta-4)}{2(\theta-1)}$	$\frac{1-6\theta}{1-\theta}$	0
5	$\frac{5}{4\theta+1}$	0	$\frac{89\theta+16}{21\theta+4}$	0	$\frac{14\theta+1}{4\theta+1}$	$\frac{7\theta+3}{4\theta+1}$	0	$\frac{27\theta+8}{4\theta+1}$	0	$\frac{1-6\theta}{1-\theta}$
6	$\frac{4\theta+1}{21\theta+4}$	$\frac{89\theta+16}{21\theta+4}$	0	0	$\frac{20(3\theta-1)}{21\theta+4}$	$\frac{10(3\theta+2)}{21\theta+4}$	0	0	$-\frac{2(27\theta+8)}{21\theta+4}$	$\frac{5(9\theta-4)}{2(\theta-1)}$
7	0	0	0	$\frac{47}{2}$	0	$\frac{5}{2}$	$\frac{5(2\theta-1)}{2}$	$-\frac{5}{2}$	-4	0
8	0	$\frac{47}{11}$	0	0	0	$\frac{30}{11}$	$\frac{20(3\theta-1)}{11}$	0	$-\frac{34}{11}$	$\frac{5}{11}$
9	0	0	$\frac{47}{4}$	0	0	$\frac{7}{2}$	$\frac{11}{(14\theta+1)}$	$\frac{17}{2}$	0	$\frac{11}{2}$
10	$\frac{47}{2\theta+3}$	0	0	0	0	$\frac{10}{2\theta+3}$	0	$-\frac{20(3\theta-1)}{2\theta+3}$	$-\frac{2(14\theta+1)}{2\theta+3}$	$\frac{1-10\theta}{2\theta+3}$
11	0	$\frac{21}{5}$	0	0	6	0	$-2(3\theta+2)$	0	-2	-5
12	0	0	$\frac{21}{2}$	0	7	0	$-7\theta-3$	5	0	-5
13	0	0	0	0	0	0	-10	-30	-14	-5
14	$\frac{21}{1-\theta}$	0	0	0	$\frac{10}{1-\theta}$	0	0	$\frac{10(3\theta+2)}{1-\theta}$	$\frac{2(7\theta+3)}{1-\theta}$	-5

Table 5. Candidate Solutions of Example 3

Solution No.	x_1	x_2	λ_1	λ_2	λ_3	λ_4	λ_5
1	20833.3	$16666.7(\theta_1-0.5)$	$\frac{6.375}{\theta_1-0.153}$	0	$\frac{12.375-30\theta_1}{0.153-\theta_1}$	0	0
2	$\frac{60000(\theta_2-1.2)}{\theta_2-1.8}$	$\frac{10000}{\theta_2-1.8}$	0	-183.6	$\frac{54-81\theta_2}{1.8-\theta_2}$	0	0
3	$\frac{30000(\theta_2-0.366)}{\theta_1\theta_2-0.275}$	$15000-20000.\theta_1$	$\frac{6.75-10.125\theta_2}{0.275-\theta_1\theta_2}$	$\frac{108\theta_1-44.55}{\theta_1\theta_2-0.275}$	0	0	0
4	0	16666.7	$\frac{6.75-10.125\theta_2}{0.275-\theta_1\theta_2}$	0	30	-5.1	0
5	60000	0	0	0	81	0	18.3
6	0	0	0	0	0	-8.1	-10
7	0	$\frac{20000}{\theta_1}$	0	$\frac{108}{\theta_2}$	0	$\frac{5.4}{\theta_2}-8.1$	0
8	40000	0	0	162	0	0	-10
9	0	54545.5	24.5455	0	0	$19.64\theta_1-8.1$	0
10	$\frac{30000}{\theta_1}$	0	$\frac{10.125}{\theta_1}$	0	0	0	$\frac{4.45}{\theta_1}-10.8$

definition describes a polyhedron. The reason semi-algebraic sets are introduced thus, is the ability to describe both convex and nonconvex sets that may be discontinuous as is shown later on in the work in Example 4.

PROPOSITION. *Semi-algebraic sets of \mathbb{R}^{n_x} can be written as a finite union of semi-algebraic sets of the form³¹*
 $\{\mathbf{x} \in \mathbb{R}^{n_x} | f_1(\mathbf{x}) = \dots = f_\omega(\mathbf{x}) = 0, g_1(\mathbf{x}) > 0, \dots, g_m(\mathbf{x}) > 0\}$

where $f_1, \dots, f_\omega, g_1, \dots, g_m$ are in $\mathfrak{g} \in \mathbb{R}[X]$.

For the proof of the proposition the interested reader is referred to the book of Bochnak et al.³¹

THEOREM 2. (Critical regions of the global mp-LP) The critical regions of an multi-parametric linear programming problem, when global uncertainty is considered, are semi-algebraic sets defined by fractional polynomial functions and are not necessarily convex nor continuous. Within a CR the corresponding optimiser is continuous but not necessarily continuous in the original parametric space, Θ .

A CR is the region of parametric space where each parametric solution remains optimal. Having said that the generic definition of a CR would be as follows

$$CR = \{\theta \in \Theta | \check{\lambda}(\theta) \geq \mathbf{0} \wedge \check{\mathbf{g}}(\mathbf{x}) \leq \mathbf{0}\} \quad (13)$$

where $\check{\lambda}(\theta)$ is the vector of Lagrange multipliers of the active constraints and $\check{\mathbf{g}}(\mathbf{x})$ is the vector of inactive constraints. Substituting Eq. 11 and 12 in Eq. 13 leads to

$$CR = \{\theta \in \Theta | -c_i(\theta) \frac{\det(\check{A}_i(\theta))}{\det(\check{A}(\theta))} \geq \mathbf{0} \wedge \check{A}_i(\theta)(\check{\mathbf{b}}_i + \check{F}_i(\theta)) \frac{\det(\check{A}_i(\theta))}{\det(\check{A}(\theta))} - \check{\mathbf{b}}_i - \check{F}_i(\theta) \leq \mathbf{0}\} \quad (14)$$

Note that based on Theorem 1 the Lagrange multipliers are fractional polynomial functions of θ and the vector of inactive constraints form a set of fractional polynomial inequalities of θ and thus the CRs are semi-algebraic sets defined by fractional polynomial functions and are not necessarily convex. As mentioned in Theorem 1, for the inverse of the parametric matrix to exist, the determinant of the parametric matrix corresponding to the active constraints should be non-zero. Based on the definition of semi-algebraic sets, such condition can be expressed in the definition of a CR and thus: the optimiser and the Lagrange multipliers are continuous within the corresponding CR but not necessarily continuous over the entire parametric space Θ . ■

Case studies

In this section, six problems are presented to illustrate the generality as well as the advantages of the proposed methodology over the ones that have been proposed so far in the literature. First, two small linear parametric problems with LHS uncertainty from Gal²² and Khalipour and Karimi²⁶ are examined, then a mp-LP with LHS uncertainty is solved so as to illustrate the exact computation of the nonconvex CRs that arise from the LHS uncertainty. The fourth example is solved to illustrate the discontinuous nature of the underlying parametric optimisation problem. Next, we present an mp-LP with global uncertainty (LHS, RHS, OFC) to underline the generality of the proposed methodology and finally the proposed methodology is applied on a the optimisation of a thermal cracker under global uncertainty.

REMARK. *In this work, the analytical solution and the comparison procedure employed was performed in Mathematica 10. In general, this can be done in any symbolic*

Table 6. Final Results of Example 1

Solution No.	x_1	x_2	x_3	x_4	$z(\theta)$	CR
1	$-\frac{21}{\theta-1}$	0	0	$\frac{89\theta+16}{2(\theta-1)}$	$\frac{5(89\theta-68)}{2(\theta-1)}$	$\theta \in (-\infty, -\frac{16}{89}]$
2	$\frac{47}{2\theta+3}$	0	0	0	$\frac{470}{2\theta+3}$	$\theta \in [-\frac{16}{89}, -\frac{1}{14}]$
3	$\frac{5}{4\theta+1}$	0	$\frac{89\theta+16}{2(4\theta+1)}$	0	$\frac{623\theta+162}{4\theta+1}$	$\theta \in [-\frac{1}{14}, \frac{1}{6}]$
4	0	$\frac{21}{5}$	0	$\frac{2}{5}$	$\frac{319}{2}$	$\theta \in [\frac{1}{6}, +\infty)$

manipulation platform such as Maple, MuPAD in Matlab or SymPy using Python programming language to name a few. Because of that, the scale of the problems that the proposed algorithm can cope with is highly dependent on the platform that is used but given the current state of the art in symbolic manipulation software the proposed algorithm can solve problems of small to medium scale.

EXAMPLE 1. (Parametric linear LHS with unbounded parameter) To validate the proposed methodology the present example from Gal²² was examined which involves an unbounded single parameter in the first row of technology matrix. The corresponding parametric problem is given by Eq. 15–19

$$z(\theta) = \max_x 10x_1 + 30x_2 + 14x_3 + 5x_4 \quad (15)$$

Subject to

$$(1-\theta)x_1 + 5x_2 + 2x_3 \leq 21 \quad (16)$$

$$(3+2\theta)x_1 + 11x_2 + 4x_3 + 2x_4 \leq 47 \quad (17)$$

$$x_i \geq 0, \quad \forall i=1, \dots, 4 \quad (18)$$

$$\theta \in \mathbb{R} \quad (19)$$

Following the proposed algorithm 14 candidate solutions are computed and given in Table 4.

As shown in Table 4, from the 14 candidate solutions the first, third, seventh, eighth, 11th–14th violate the non-negativity of the Lagrange multipliers and are subsequently discarded. After the 13th step of the proposed algorithm where the evaluation of the non-negativity of the Lagrange multipliers and the negativity of the inequality constraints is performed, four solutions are feasible and as none of them overlap, they are the final explicit solutions of Example 1.

REMARK. Note that in this case study, the uncertain set is unbounded. In principle, the proposed algorithm can facilitate parametric unboundedness but for larger problems that

leads to excessive computations because of the increase in the possible CRs.

In Table 6, the parametric solutions and the corresponding CRs are listed which are the same as the ones computed following the methodology of Gal.²²

To demonstrate the computation of the CRs the steps of computing CR₂ are demonstrated. CR₂ corresponds to the 10th candidate solution and is formulated by the intersection of the parametric ranges defined by the inequalities (3 and 4) which are as given by (20)

$$\begin{cases} -\frac{89\theta+16}{2\theta+3} \leq 0 \\ -\frac{47}{2\theta+3} \leq 0 \\ \frac{10}{2\theta+3} \geq 0 \\ \frac{20-60\theta}{2\theta+3} \geq 0 \\ -\frac{28\theta+2}{2\theta+3} \geq 0 \\ \frac{5-10\theta}{2\theta+3} \geq 0 \end{cases} \rightarrow \theta \in \left[-\frac{16}{89}, -\frac{1}{14}\right] \quad (20)$$

For the sake of clarity, in Figure 2 the different parametric ranges where each constraint is satisfied are given. Note that the set of constraints that leads to the definition of the CRs are the Lagrange multipliers of the active constraints and the inactive constraints. In Figure 2, above from the parametric ranges the corresponding inequality is defined as well as the resulting parametric range where it is valid. As can be observed from the Figure 2, CR₂ is defined as the space where all the constraints are satisfied and for illustration purposes is marked with a red rectangle.

Note that in the inequalities given by Eq. 20 the point $\theta = -\frac{3}{2}$ is point where the corresponding explicit solution cannot

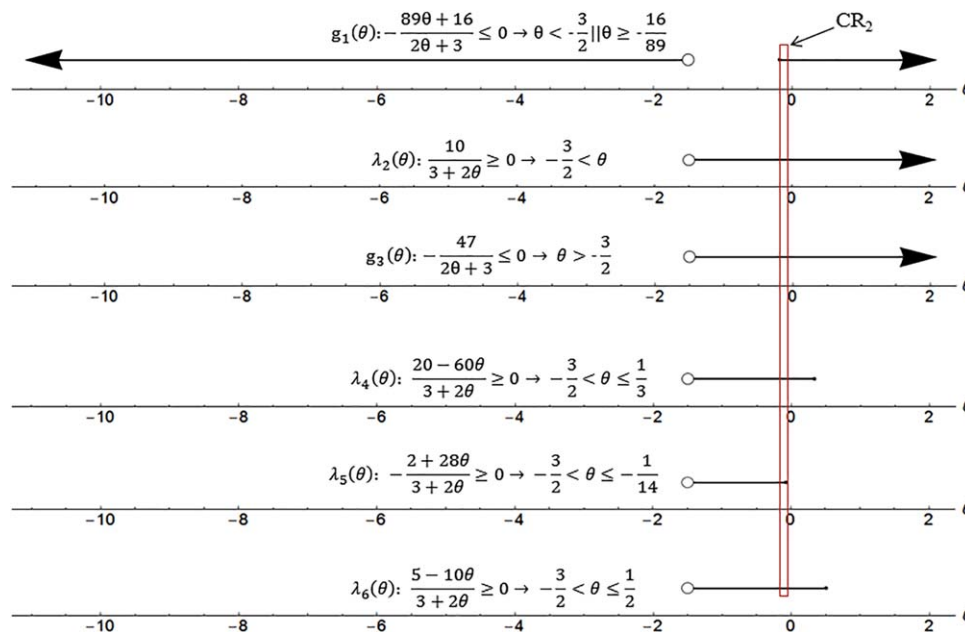

Figure 2. Graphical definition of CR₂ for Example 1.

[Color figure can be viewed at wileyonlinelibrary.com]

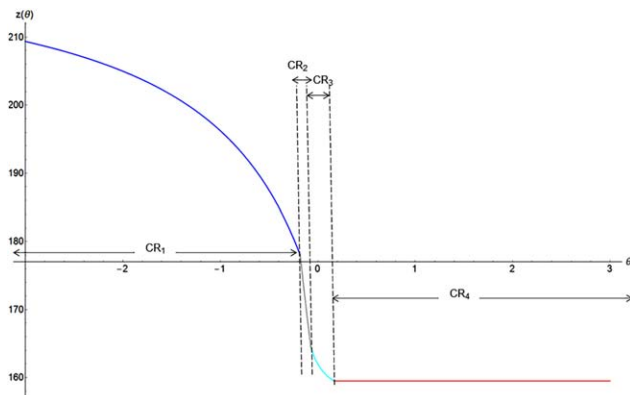

Figure 3. Plot of the explicit objective function and the CRs in the parametric space of example 1.

[Color figure can be viewed at wileyonlinelibrary.com]

be defined and is not included in CR_2 . Finally, in Figure 3 the graph of the objective function across the corresponding CRs for Example 1 is given. Notice that despite the fact that each explicit solution may not be continuous in original parametric space, each continuity is preserved within its corresponding CR.

EXAMPLE 2. (Parametric linear LHS) Next, an example from Khalilpour and Karimi²⁶ was chosen. This problem is a parametric problem with LHS uncertainty given by Eq. 21–25.

$$z(\theta) = \min_{\mathbf{x}} x_1 + 1.5x_2 + 3x_3 \quad (21)$$

Subject to:

$$x_1 + (1 + 2\theta)x_2 + 2x_3 \geq 6 \quad (22)$$

$$(1 + \theta)x_1 + 2x_2 + x_3 \geq 10 \quad (23)$$

$$-100 \leq \theta \leq 100 \quad (24)$$

$$x_i \geq 0, \forall i=1, 2, 3 \quad (25)$$

In this example, the uncertain parameter θ is found in two different rows of the technology matrix and in different columns. Following the proposed algorithm, first we formulated the Lagrangian function of the problem as shown by Eq. 26.

$$\begin{aligned} L(x_1, x_2, x_3, \lambda_1, \lambda_2, \lambda_3, \lambda_4, \lambda_5, \theta) \\ = -\lambda_3 x_1 + \lambda_1(-x_1 - (2\theta + 1)x_2 - 2x_3 + 6) \\ + \lambda_2((-\theta - 1)x_1 - 2x_2 - x_3 + 10) \\ + x_1 - \lambda_4 x_2 + 1.5x_2 - \lambda_5 x_3 + 3x_3 \end{aligned} \quad (26)$$

Next, the gradient of the Lagrangian is computed with respect to the optimisation variables as shown in Eq. 27.

$$\nabla_{x_1, x_2, x_3} L = [(-\theta - 1)\lambda_2 - \lambda_1 - \lambda_3 + 1, (-2\theta - 1)\lambda_1 - 2\lambda_2 - \lambda_4 + 1.5, -2\lambda_1 - \lambda_2 - \lambda_5 + 3]^T \quad (27)$$

Note that the components of the gradient are explicit functions of the Lagrange multipliers and the uncertain parameter because of the linearity of the original optimisation problem. Solving the system of equations derived by the corresponding first order KKT conditions results in 10 candidate solutions. Following the proposed methodology, we compute the explicit solution along with the parametric intervals, since there is only one uncertain parameter. The results of this example are given in Table 7.

As shown the parametric intervals are in total agreement with the ones computed following the algorithm of Khalilpour and Karimi.²⁶ Apart from the parametric intervals note that following the proposed algorithm the explicit form of the objective function is computed as well in contrast with the aforementioned algorithm. In Figure 4, the optimal value function can be envisaged across the range of parametric variability; note that the different colors indicate different explicit functions and consequently the range that the curve is plotted for indicates the corresponding CR.

So far, the examples examined, considered only one parameter that could vary simultaneously in one or more entries of the technology matrix. Next, we extend to the cases where more than one parameter is considered in the mp-LP and global uncertainty is treated.

EXAMPLE 3. (Multi-parametric linear LHS) A crude oil refinery example³² was chosen and slightly modified to facilitate the test of the proposed algorithm. The optimisation problem with LHS uncertainty is given by Eq. 28–32.

$$z(\theta_1, \theta_2) = \max_{\mathbf{x}} 8.1x_1 + 10.8x_2 \quad (28)$$

Subject to:

$$\theta_1 x_1 + 0.44x_2 \leq 24000 \quad (29)$$

$$0.05x_1 + 0.10\theta_2 x_2 \leq 2000 \quad (30)$$

$$0.10x_1 + 0.36x_2 \leq 6000 \quad (31)$$

Table 7. Validation of the Example 2 by Khalilpour and Karimi (2014)

i	Explicit Solution ($z_i(\theta)$)	CR_i	CR_i Computed by Khalilpour and Karimi ²⁶
1	$-\frac{10.5}{-1.5+\theta} + \frac{30(-0.1+\theta)}{-1.5+\theta}$	$-100 \leq \theta \leq -0.9340$	$-100 \leq \theta \leq -0.9340$
2	$\frac{4.5(\theta-0.666667)}{\theta^2+1.5\theta-0.5} + \frac{10(\theta-0.1)}{\theta^2+1.5\theta-0.5}$	$-0.9340 \leq \theta \leq 0.1010$	$-0.9340 \leq \theta \leq 0.1010$
3	7.5	$0.1010 \leq \theta \leq 0.3340$	$0.1010 \leq \theta \leq 0.3340$
4	$\frac{10}{\theta+1}$	$0.3340 \leq \theta \leq 0.6670$	$0.3340 \leq \theta \leq 0.6670$
5	6	$0.6670 \leq \theta \leq 100$	$0.6670 \leq \theta \leq 100$

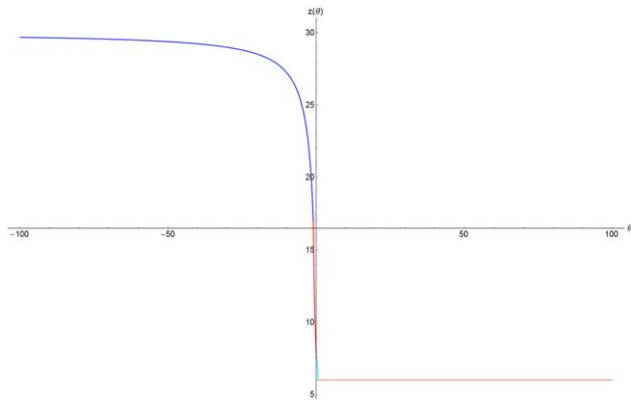

Figure 4. Graph of the optimal explicit objective value across the parametric range of variability for Example 2 (see Table 7 for the CRs intervals). [Color figure can be viewed at wileyonlinelibrary.com]

$$x_1, x_2 \geq 0 \quad (32)$$

$$-10 \leq \theta_{1,2} \leq 10 \quad (33)$$

The Lagrangian is given by Eq. 34 while the gradient of the Lagrangian is given by Eq. 35.

$$\begin{aligned} \mathcal{L}(x_1, x_2, \lambda_1, \lambda_2, \lambda_3, \lambda_4, \lambda_5, \theta_1, \theta_2) \\ = -(8.1x_1 + 10.8x_2) + \lambda_1(\theta_1x_1 + 0.44x_2 - 24000) \\ + \lambda_2(0.05x_1 + 0.10\theta_2x_2 - 2000) + \lambda_3(0.10x_1 + 0.36x_2 - 6000) \\ + \lambda_4(-x_1) + \lambda_5(-x_2) \end{aligned} \quad (34)$$

$$\begin{aligned} \nabla_{x_1, x_2} \mathcal{L} = (0.8\theta_1\lambda_1 + 0.05\lambda_2 + 0.1\lambda_3 - \lambda_4 - 8.1, 0.1\theta_2\lambda_2 \\ + 0.44\lambda_1 + 0.36\lambda_3 - \lambda_5 - 10.8)^T \end{aligned} \quad (35)$$

Note, that the gradient of the Lagrangian in Eq. 34 is a non-linear function of the Lagrange multipliers and the uncertain parameters as products of the form $\lambda \cdot \theta$ occur. With the above computed the first order KKT conditions are given by Eq. 28–32.

$$0.8\theta_1\lambda_1 + 0.05\lambda_2 + 0.1\lambda_3 - \lambda_4 - 8.1 = 0 \quad (36)$$

$$0.1\theta_2\lambda_2 + 0.44\lambda_1 + 0.36\lambda_3 - \lambda_5 - 10.8 = 0 \quad (37)$$

$$\lambda_1(\theta_1x_1 + 0.44x_2 - 24000) = 0 \quad (38)$$

$$\lambda_2(0.05x_1 + 0.10\theta_2x_2 - 2000) = 0 \quad (39)$$

$$\lambda_3(0.10x_1 + 0.36x_2 - 6000) = 0 \quad (40)$$

$$\lambda_4(-x_1) = 0 \quad (41)$$

$$\lambda_5(-x_2) = 0 \quad (42)$$

The solution of the square system of equations derived by the first-order KKT conditions is solved symbolically using Mathematica 10, with respect to the following variables: $x_1, x_2, \lambda_1, \lambda_2, \lambda_3, \lambda_4, \lambda_5$ and as a result the candidate solutions computed at this step will be parametric in θ_1 and θ_2 . Solving the system of Eq. (28)–(32), leads to the following candidate solutions as shown in Table 5.

Evaluating with the optimality and feasibility conditions, that is, Eqs. 3 and 4, from the 10 candidate solutions computed in the first step of the algorithm, only 4 solutions are qualified and thus after the comparison procedure are the final explicit solutions of the system and are given in Table 8 while the corresponding CRs are given in Table 9.

Visually the CRs of the present example are presented in Figure 5, while a 3-D plot of the objective function in the parametric space is shown in Figure 6.

To demonstrate the scalability of the proposed algorithm, we revisit the same example with more uncertain parameters as shown below

$$z(\theta_1, \theta_2, \theta_3, \theta_4, \theta_5, \theta_6, \theta_7) = \max_x \theta_1x_1 + \theta_2x_2 \quad (43)$$

Subject to

$$\theta_3x_1 + 0.44x_2 \leq 24000 + \theta_4 \quad (44)$$

$$0.05x_1 + \theta_5x_2 \leq \theta_6 \quad (45)$$

$$0.10x_1 + 0.36x_2 \leq \theta_7 \quad (46)$$

$$x_1, x_2 \geq 0 \quad (47)$$

$$\begin{aligned} 9 \leq \theta_1 \leq 12, 10 \leq \theta_2 \leq 13, 0.1 \leq \theta_3 \leq 0.3, 0 \leq \theta_4 \leq 3000, \\ 0.2 \leq \theta_5 \leq 0.5, 2000 \leq \theta_6 \leq 6000, 4000 \leq \theta_7 \leq 8000 \end{aligned} \quad (48)$$

In the augmented version, again the analytical solution returns 10 candidate solutions out of which only three are feasible. For purposes of illustration, in Table 10, the map of candidate solutions is provided where the highly nonconvex nature of the problem can be further understood. As it can be seen, despite the fact that the number of candidate

Table 8. Explicit Solutions of Example 3

Explicit Solutions	Mathematical Expressions
$[\theta_1, \theta_2] \in \text{CR}_1$	$x_1(\theta) = \frac{60000(\theta_2 - 1.2)}{\theta_2 - 1.8}, x_2(\theta) = \frac{-10000}{\theta_2 - 1.8},$ $z(\theta) = \frac{691200 - 486000\theta_2}{1.8 - \theta_2}$
$[\theta_1, \theta_2] \in \text{CR}_2$	$x_1(\theta) = \frac{30000(\theta_2 - 0.366)}{\theta_1\theta_2 - 0.275},$ $x_2(\theta) = \frac{15000 - 20000\theta_1}{0.275 - \theta_1\theta_2},$ $z(\theta) = \frac{251100 - 216000\theta_1 - 243000\theta_2}{0.275 - \theta_1\theta_2}$
$[\theta_1, \theta_2] \in \text{CR}_3$	$x_1(\theta) = 40000, x_2(\theta) = 0,$ $z(\theta) = 324,000$
$[\theta_1, \theta_2] \in \text{CR}_4$	$x_1(\theta) = \frac{20833.3}{\theta_1 - 0.153},$ $x_2(\theta) = \frac{16666.7(\theta_1 - 0.5)}{\theta_1 - 0.153},$ $z(\theta) = \frac{180000\theta_1 + 78750}{\theta_1 - 0.153}$

Table 9. Critical Regions of Example 3

Critical Regions	Mathematical Expressions
CR ₁	$\begin{cases} -10 \leq \theta_1 \leq 0.5186 \\ -10 \leq \theta_2 \leq -0.667 \end{cases} \triangleq \begin{cases} 0.5186 \leq \theta_1 \leq 0.890625 \\ \frac{-97+144\theta_1}{-60+120\theta_1} \leq \theta_2 \leq -0.667 \end{cases}$
CR ₂	$\begin{cases} \begin{cases} 0.75 \leq \theta_1 \leq 0.890625 \\ 0.667 \leq \theta_2 \leq 10 \end{cases} \\ \triangleq \begin{cases} 0.890625 \leq \theta_1 \leq 10 \\ \begin{cases} \frac{10.5553\theta_1-7.11018}{8.79609\theta_1-4.39805} \leq \theta_2 \leq \frac{24.739\theta_1^2-26.8693\theta_1+6.8741}{20.6158\theta_1^2-18.812\theta_1+4.25202} \\ \frac{16.7109\theta_1-11.2567}{13.9258\theta_1-6.96289} \leq \theta_2 \leq 10 \end{cases} \end{cases} \end{cases}$
CR ₃	$\triangleq \begin{cases} -10 \leq \theta_1 \leq 0.75 \\ -0.667 \leq \theta_2 \leq 10 \end{cases}$
CR ₄	$\triangleq -10 \leq \theta_2 \left\{ \begin{array}{l} \begin{cases} \theta_1 = 0.7293 \\ \theta_2 \leq 0.2914 \end{cases} \\ \begin{cases} 0.5186 \leq \theta_1 \leq 0.70419 \\ \theta_2 \leq 1.2 + \frac{0.933276}{2.23986 - 4.47973\theta_1} \end{cases} \\ \begin{cases} 0.70419 \leq \theta_1 \\ \theta_2 \leq 0.17974 \end{cases} \\ \begin{cases} 0.7705 \leq \theta_1 \\ (\theta_1^4(1.18059\theta_2 - 1.41671) + \theta_1^3(3.07938 - 2.36118\theta_2) \\ + \theta_1^3(1.77089\theta_2 - 2.494)) \times 10^{33} + \\ \theta_1(8.92822 - 5.90296\theta_2) \times 10^{32} + 7.3787 \times 10^{31}\theta_2 - 1.19289 \times 10^{32} \leq 0 \end{cases} \\ \begin{cases} \theta_2 \leq 1.2 - \frac{0.2083}{\theta_1 - 0.5} \\ 0.7293 \leq \theta_1 \leq 0.8906 \end{cases} \\ \begin{cases} \theta_1^2\theta_2 - 1.2\theta_1^2 - \theta_1\theta_2 + 1.4083\theta_1 + 0.25\theta_2 \leq 0.404167 \\ 0.70419 \leq \theta_1 \leq 0.7293 \end{cases} \end{array} \right.$

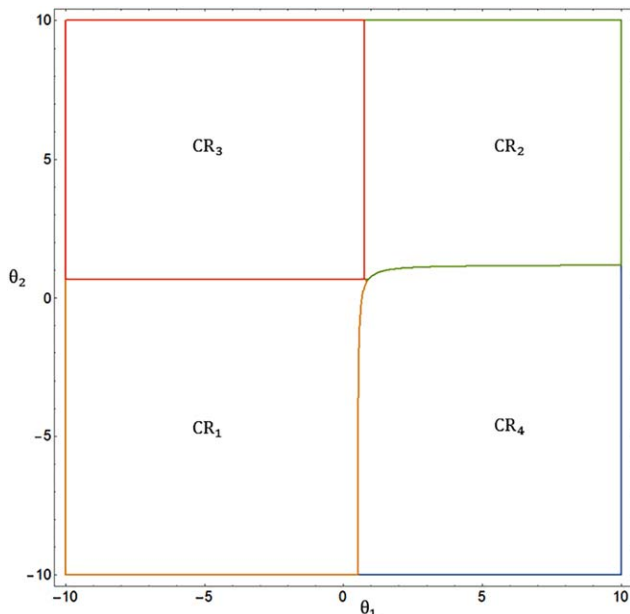

Figure 5. Critical regions of Example 3.

[Color figure can be viewed at wileyonlinelibrary.com]

solutions does not scale, the nonconvex terms that appear in the problem's solution rapidly grows.

The explicit results for the problem are given in Table 11. To identify overlapping CRs the comparison procedure was followed; a number of the overlapping CRs provide identical cost-wise solutions. In this example, we chose to keep the overlap as a new CR where two different solutions are available at the same cost and remove the overlap from the original regions. Of course, an alternative would have been to keep only one CR as dominant (when only the optimal cost is of interest and not the underlying choices) and that would reduce the computational complexity from the procedure to locate the CRs at the expense of less insight that can be valuable for the decision making.

In more detail, CR_1 was found to be overlapping with both CR_2 and CR_3 and that led to CR_1^{fin} , CR_1CR_2 , CR_1CR_3 ,

CR_2^{new} , CR_3^{new} while CR_2^{new} overlaps with the entire CR_3^{new} and thus leading to CR_2^{fin} , CR_2CR_3 , where CR_iCR_j denotes that overlap that after that step is considered as a CR and has been removed from the original ones (CR_i, CR_j) thus leading to new nonoverlapping CRs (CR_i^{new}, CR_j^{new}). The CR_2^{new} and CR_3^{new} are the intermediate CRs created during the comparison procedure and are not provided in the article for the sake of space. This example illustrates how flexible the decision-making procedure can be as with the procedure followed (keep overlapping CRs for better insight in the decision making) the number of final CRs is 5 albeit only 2 final CRs are needed when the cost-wise criteria are more important.

EXAMPLE 4. (Discontinuous mp-LP with LHS uncertainty) This example is a modified version of the one presented by Dinkelbach.³³ We chose to work on this specific example because as shown later on, the explicit solution involves fragmented CRs and a discontinuous objective function in the original parametric space

$$z(\theta_1, \theta_2) = \min_{\mathbf{x}} 2x_1 - x_2 \quad (49)$$

Subject to

$$(3 - \theta_2)x_1 + (2 - \theta_1)x_2 \leq 2 \quad (50)$$

$$-\theta_1x_1 - \theta_2x_2 \leq -1 \quad (51)$$

$$x_{1,2} \leq 0 \quad (52)$$

$$-25 \leq \theta_{1,2} \leq 25 \quad (53)$$

This example involves two uncertain parameters located in both rows and columns of the A matrix. First, the first order KKT conditions are calculated and the corresponding system of polynomial equations in $\mathbf{x}, \boldsymbol{\lambda}, \boldsymbol{\theta}$ is solved using Mathematica. In principle, the procedure followed is to compute the Groebner Bases of the polynomial system of equations and then proceed with back-substitutions so as to solve the triangular system that arises. The Groebner Bases of this example using lexicographic order for the monomials with $\mathbf{x} > \boldsymbol{\lambda}$, is given by Eq. 54.

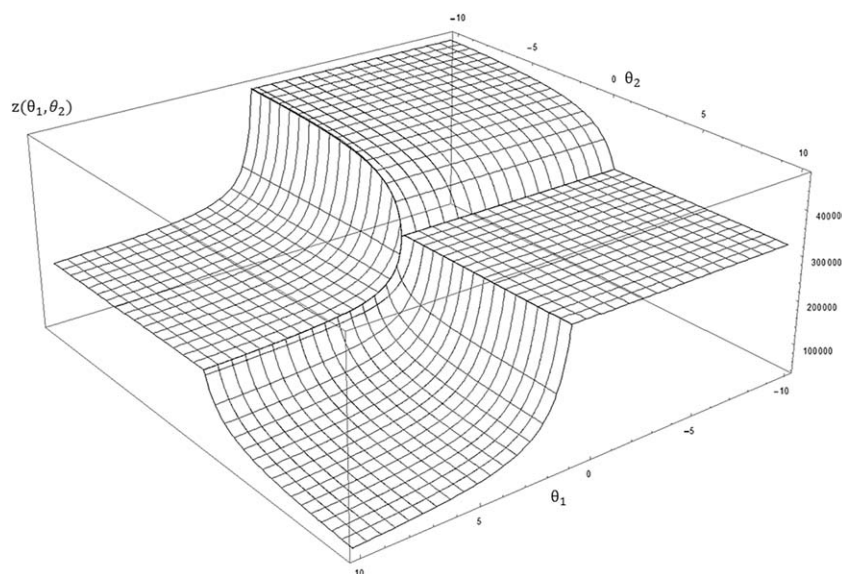

Figure 6. Three-dimensional plot of the objective function for the Example 3 in the parametric space.

(a) CRs plot; (b) Visualisation of the cost function in the parametric space.

Table 10. Candidate Solutions for Example 3, with seven Uncertain Parameters

Solution No.	x_1	x_2	λ_1	λ_2	λ_3	λ_4	λ_5
1	$\frac{\theta_4\theta_5 + 24000\theta_5 - 0.44\theta_6}{\theta_3\theta_5 - 0.022}$	$\frac{\theta_3\theta_5\theta_6 - 0.05\theta_4\theta_5 - 1200\theta_5 + 3.47 \cdot 10^{-18}\theta_6}{\theta_5(\theta_3\theta_5 - 0.022)}$	$-\frac{0.05\theta_2 - \theta_1\theta_5}{\theta_3\theta_5 - 0.022}$	$-\frac{0.44(\theta_1 - 2.27\theta_2\theta_3)}{\theta_3\theta_5 - 0.022}$	0	0	0
2	$\frac{\theta_4 - 1.22\theta_7 + 24000}{\theta_3 - 0.122}$	$\frac{2.78(\theta_3\theta_7 - 0.1\theta_4 + 4 \cdot 10^{-17}\theta_7 - 2400)}{\theta_3 - 0.122}$	$\frac{\theta_1 - 0.278\theta_2}{\theta_3 - 0.122}$	0	$\frac{2.78(\theta_2\theta_3 - 0.44\theta_1)}{\theta_3 - 0.122}$	0	0
3	$\frac{10\theta_5\theta_7 - 3.6\theta_6}{\theta_5 - 0.18}$	$-\frac{0.5\theta_7 - \theta_6}{\theta_5 - 0.18}$	0	$-\frac{3.6(\theta_1 - 0.278\theta_2)}{\theta_5 - 0.18}$	$\frac{10(\theta_1\theta_5 + 2.22 \cdot 10^{-17}\theta_1 - 0.05\theta_2)}{\theta_5 - 0.18}$	0	0
4	0	$2.78\theta_7$	0	0	$2.78\theta_2$	$0.278\theta_2 - \theta_1$	0
5	$10\theta_7$	0	0	0	$10\theta_1$	0	$3.6\theta_1 - \theta_2$
6	0	0	0	0	0	$-\frac{\theta_1}{\theta_5}$	$-\frac{\theta_2}{0}$
7	0	$\frac{\theta_6}{\theta_5}$	0	$\frac{\theta_2}{\theta_5}$	0	$-\frac{\theta_1\theta_5 - 0.05\theta_2}{\theta_5}$	0
8	$20\theta_6$	0	0	$20\theta_1$	0	0	$20\theta_1\theta_5 - \theta_2$
9	0	$5.45 \cdot 10^4 + 2.27\theta_4$	$2.27\theta_2$	0	0	$2.27\theta_2\theta_3 - \theta_1$	0
10	$\frac{\theta_4 + 24000}{\theta_3}$	0	$\frac{\theta_1}{\theta_3}$	0	0	0	$\frac{0.44\theta_1 - \theta_2\theta_3}{\theta_3}$

$$\text{GB} := \begin{cases} \lambda_2 \lambda_3 \lambda_4 \\ \lambda_1 \lambda_3 \lambda_4 \\ 2\theta_1 \lambda_1 \lambda_2 \lambda_4 + \theta_2 \lambda_1 \lambda_2 \lambda_4 - 3\lambda_1 \lambda_2 \lambda_4 \\ \theta_1 \lambda_1 \lambda_2 \lambda_3 + 2\theta_2 \lambda_1 \lambda_2 \lambda_3 - 2\lambda_1 \lambda_2 \lambda_3 \\ \lambda_4 x_2 \\ \theta_2 \lambda_2 \lambda_3 x_2 - \lambda_2 \lambda_3 \\ 2\lambda_1 \lambda_3 + \theta_1 \lambda_1 \lambda_3 x_2 - 2\lambda_1 \lambda_3 x_2 \\ -\theta_1 \lambda_1 \lambda_2 - 2\theta_2 \lambda_1 \lambda_2 + 2\lambda_1 \lambda_2 + \theta_1^2 \lambda_1 \lambda_2 x_1 \\ -2\theta_1 \lambda_1 \lambda_2 x_1 - \theta_2^2 \lambda_1 \lambda_2 x_1 + 3\theta_2 \lambda_1 \lambda_2 x_1 \\ \lambda_3 x_1 \\ -\lambda_2 + \theta_1 \lambda_2 x_1 + \theta_2 \lambda_2 x_2 \\ 2\lambda_1 + \theta_2 \lambda_1 x_1 - 3\lambda_1 x_1 + \theta_1 \lambda_1 x_2 - 2\lambda_1 x_2 \end{cases} \quad (54)$$

To illustrate how the solution of the system is computed, a candidate solution will be computed herein and following similar procedure the rest of the candidate solutions are computed. Note that this procedure is done for illustration purposes and simply to highlight the role of Groebner Bases theory in the proposed algorithm while in the implementation done in Mathematica the command ‘‘Solve’’ is used. From the last row of the bracket in (54), using λ_1 as a common factor and λ_2 for the row above the last one we factorise the system as shown in (55).

$$\text{GB}_{\text{factored}} := \begin{cases} \lambda_2 \lambda_3 \lambda_4 \\ \lambda_1 \lambda_3 \lambda_4 \\ 2\theta_1 \lambda_1 \lambda_2 \lambda_4 + \theta_2 \lambda_1 \lambda_2 \lambda_4 - 3\lambda_1 \lambda_2 \lambda_4 \\ \theta_1 \lambda_1 \lambda_2 \lambda_3 + 2\theta_2 \lambda_1 \lambda_2 \lambda_3 - 2\lambda_1 \lambda_2 \lambda_3 \\ \lambda_4 x_2 \\ \theta_2 \lambda_2 \lambda_3 x_2 - \lambda_2 \lambda_3 \\ 2\lambda_1 \lambda_3 + \theta_1 \lambda_1 \lambda_3 x_2 - 2\lambda_1 \lambda_3 x_2 \\ -\theta_1 \lambda_1 \lambda_2 - 2\theta_2 \lambda_1 \lambda_2 + 2\lambda_1 \lambda_2 + \theta_1^2 \lambda_1 \lambda_2 x_1 \\ -2\theta_1 \lambda_1 \lambda_2 x_1 - \theta_2^2 \lambda_1 \lambda_2 x_1 + 3\theta_2 \lambda_1 \lambda_2 x_1 \\ \lambda_3 x_1 \\ \lambda_2(-1 + \theta_1 x_1 + \theta_2 x_2) \\ \lambda_1(2 + \theta_2 x_1 - 3x_1 + \theta_1 x_2 - 2x_2) \end{cases} \quad (55)$$

Now, let us consider the scenario for which $x_1=0$ and $\lambda_3 \neq 0$ such that the row 3 from the bottom is always satisfied. For $x_1=0$, the system (55) allows us to compute x_2 from the last row as shown in (56).

$$\begin{cases} \lambda_2 \lambda_3 \lambda_4 \\ \lambda_1 \lambda_3 \lambda_4 \\ 2\theta_1 \lambda_1 \lambda_2 \lambda_4 + \theta_2 \lambda_1 \lambda_2 \lambda_4 - 3\lambda_1 \lambda_2 \lambda_4 \\ \theta_1 \lambda_1 \lambda_2 \lambda_3 + 2\theta_2 \lambda_1 \lambda_2 \lambda_3 - 2\lambda_1 \lambda_2 \lambda_3 \\ \lambda_4 x_2 \\ \theta_2 \lambda_2 \lambda_3 x_2 - \lambda_2 \lambda_3 \\ 2\lambda_1 \lambda_3 + \theta_1 \lambda_1 \lambda_3 x_2 - 2\lambda_1 \lambda_3 x_2 \\ -\theta_1 \lambda_1 \lambda_2 - 2\theta_2 \lambda_1 \lambda_2 + 2\lambda_1 \lambda_2 + \theta_1^2 \lambda_1 \lambda_2 x_1 - 2\theta_1 \lambda_1 \lambda_2 x_1 \\ -\theta_2^2 \lambda_1 \lambda_2 x_1 + 3\theta_2 \lambda_1 \lambda_2 x_1 \\ \lambda_3 x_1 \\ x_2 = \frac{1}{\theta_2} \\ x_1 = 0 \end{cases} \quad (56)$$

Having computed the explicit expression of $x_2=f(\theta)$, we can now compute λ_3 from the seventh row of the system (56), under the scenario that $\lambda_1=0$.

$$\begin{cases} \lambda_2 \lambda_3 \lambda_4 \\ \lambda_1 \lambda_3 \lambda_4 \\ 2\theta_1 \lambda_1 \lambda_2 \lambda_4 + \theta_2 \lambda_1 \lambda_2 \lambda_4 - 3\lambda_1 \lambda_2 \lambda_4 \\ \theta_1 \lambda_1 \lambda_2 \lambda_3 + 2\theta_2 \lambda_1 \lambda_2 \lambda_3 - 2\lambda_1 \lambda_2 \lambda_3 \\ \lambda_4 x_2 \\ \theta_2 \lambda_2 \lambda_3 x_2 - \lambda_2 \lambda_3 \\ -\theta_1 \lambda_1 \lambda_2 - 2\theta_2 \lambda_1 \lambda_2 + 2\lambda_1 \lambda_2 + \theta_1^2 \lambda_1 \lambda_2 x_1 - 2\theta_1 \lambda_1 \lambda_2 x_1 \\ -\theta_2^2 \lambda_1 \lambda_2 x_1 + 3\theta_2 \lambda_1 \lambda_2 x_1 \\ x_2 = \frac{1}{\theta_2} \\ x_1 = 0 \\ \lambda_1 = 0 \\ \lambda_3 = -\frac{\theta_1(2\theta_2+1)}{\theta_2} \end{cases} \quad (57)$$

Following similar reduction steps of factorisation, we end up with the following system of explicit expressions (58) which forms a candidate solution to the original KKT system of the example.

$$\begin{cases} x_1 = 0 \\ x_2 = \frac{1}{\theta_2} \\ \lambda_1 = 0 \\ \lambda_2 = -\frac{1}{\theta_2} \\ \lambda_3 = -\frac{\theta_1(2\theta_2+1)}{\theta_2} \\ \lambda_4 = 0 \end{cases} \quad (58)$$

The procedure given above for the computation of the candidate solutions given the Groebner basis is rather for illustration purposes and for the sake of clarity rather than implementation purposes. In fact, in the literature of Groebner basis theory, one can find rules to optimise the performance of the reduction procedure; such details are beyond the scope of the present article but the interested reader is referred to the book of Buchberger and Winkler.³⁴

Following the steps of the proposed algorithm, we compute two explicit solutions while their corresponding CRs as given in Table 12.

As shown in Figure 7, it is interesting to note that CR₁ (colored gray) is discontinuous and fragmented in two parts both involving the same explicit solution. The reason why this example was modified and solved is twofold: first, as illustrated in Figure 7a, the discontinuity poses a significant challenge on the implementation of the already existing algorithms for mp-LPs as the ‘‘neighboring’’ property does not hold in the discontinuous instance of the parametric space. Moreover, one when solving the present example might consider that there exist 3 CRs and not 2, leading thus in unnecessary increase of the dimensions of the explicit solution. This is due to the fact that, the algorithms proposed so far in the literature of mp-P are based on solution of problems with a valued parameter vector, that is, one has to first find a feasible point in the parametric space collect the postoptimal information needed and then repeat this procedure until the entire feasible parametric space is covered.

Table 11. Final Results of the Example 3, with 7 Uncertain Parameters

Explicit solutions	x_1	x_2	$z(\theta_1, \theta_2, \theta_3, \theta_4, \theta_5, \theta_6, \theta_7)$
if $[\theta_1, \theta_2] \in CR_1$ or CR_1CR_2 or CR_1CR_3	$10\theta_7$	0	$10\theta_1\theta_7$
if $[\theta_1, \theta_2] \in CR_2$ or CR_1CR_2 or CR_2CR_3	$20\theta_6$	0	$20\theta_1\theta_6$
if $[\theta_1, \theta_2] \in CR_3$ or CR_2CR_3	$\frac{\theta_4+24000}{\theta_3}$	0	$\theta_1 \frac{\theta_4+24000}{\theta_3}$

Critical Regions	Mathematical Expressions
$CR_1 \triangleq \begin{cases} 9 \leq \theta_1 \leq 12 \\ 10 \leq \theta_1 \leq 13 \\ 0.1 \leq \theta_3 \leq 0.3 \\ 0 \leq \theta_4 \leq 3000 \\ 0.2 \leq \theta_5 \leq 0.5 \\ \begin{cases} 2000 \leq \theta_6 \leq 4000 \\ 4000 \leq \theta_7 \leq 2\theta_6 \end{cases} \\ \begin{cases} 4000 \leq \theta_6 \leq 6000 \\ 4000 \leq \theta_7 \leq 8000 \end{cases} \end{cases}$	$CR_1CR_3 \triangleq \begin{cases} 9 \leq \theta_1 \leq 12 \\ 10 \leq \theta_1 \leq 13 \\ 0.1 \leq \theta_3 \leq 0.3 \\ 0 \leq \theta_4 \leq 3000 \\ 0.2 \leq \theta_5 \leq 0.5 \\ 4000 \leq \theta_6 \leq 6000 \\ \theta_7=8000 \end{cases}$
$CR_1CR_2 \triangleq \begin{cases} 9 \leq \theta_1 \leq 12 \\ 10 \leq \theta_1 \leq 13 \\ 0.1 \leq \theta_3 \leq 0.3 \\ 0 \leq \theta_4 \leq 3000 \\ 0.2 \leq \theta_5 \leq 0.5 \\ 2000 \leq \theta_6 \leq 4000 \\ \theta_7=2\theta_6 \end{cases}$	$CR_2 \triangleq \begin{cases} 9 \leq \theta_1 \leq 12 \\ 10 \leq \theta_1 \leq 13 \\ 0.1 \leq \theta_3 \leq 0.3 \\ 0 \leq \theta_4 \leq 3000 \\ 0.2 \leq \theta_5 \leq 0.5 \\ 2000 \leq \theta_6 \leq 4000 \\ 2\theta_6 \leq \theta_7 \leq 8000 \end{cases}$
	$CR_2CR_3 \triangleq \begin{cases} 9 \leq \theta_1 \leq 12 \\ 10 \leq \theta_1 \leq 13 \\ \theta_3=0.3 \\ \theta_4=0 \\ 0.2 \leq \theta_5 \leq 0.5 \\ \theta_6=4000 \\ \theta_7=8000 \end{cases}$

Following this algorithmic routine however, one would have to perform two steps for the identification of a single CR for the case of discontinuous regions.

EXAMPLE 5. (Multi-parametric global mp-LP) To illustrate the case of global uncertainty in general mp-LPs the following example is taken from Li and Ierapetritou (L&I)²³

$$z(\theta_1, \theta_2, \theta_3) = \min_x \theta_1 x_1 + x_2 \quad (59)$$

Subject to

$$-x_1 + x_2 + x_3 = \theta_2 \quad (60)$$

$$x_1 - \theta_3 x_2 + x_4 = 1 \quad (61)$$

$$x_i \geq 0, \forall i=1, \dots, 4 \quad (62)$$

$$-5 \leq \theta_q \leq 5, \forall q=1, 2, 3 \quad (63)$$

In this example, the most generic case of a multi-parametric LP problem is considered, that is, uncertainty in the RHS, LHS, and OFC simultaneously. Following Algorithm 1, the results are given in Table 13 and a comparison with results from Li and Ierapetritou²³ is presented.

As observed, the CRs computed are different from the ones computed in the work of Li and Ierapetritou,²³ this is because of the core difference between the two approaches: following the approach proposed in Li and Ierapetritou,²³ the accuracy of the approximation for the nonconvex CRs arising from the LHS uncertainty is highly dependent on the projection methodology that is employed as well as the degree of discretisation of the parametric space, while in the proposed methodology exact nonconvex CRs are computed from the analytic solution of the global mp-LP. For better understanding, in Figure 8, the different CRs are presented

Table 12. Explicit Solutions and CRs of Example 4

i	$x_1^i(\theta_1, \theta_2)$	$x_2^i(\theta_1, \theta_2)$	$z^i(\theta_1, \theta_2)$	CR _i
1	$-\frac{\theta_1 - 2\theta_2 + 2}{\theta_1^2 - 2\theta_1 - \theta_2^2 + 3\theta_2}$	$-\frac{-2\theta_1 - \theta_2 + 3}{\theta_1^2 - 2\theta_1 - \theta_2^2 + 3\theta_2}$	$\frac{4\theta_1 + 5\theta_2 - 7}{\theta_1^2 - 2\theta_1 - (\theta_2 - 3)\theta_2}$	$\left\{ \begin{array}{l} -11 < \theta_1 < 0 \\ 2\theta_1 + \theta_2 \leq 3 \\ -22.5 < \theta_1 \leq -11 \\ \theta_2 \leq 25 \end{array} \right.$
2	0	$\frac{1}{\theta_2}$	$-\frac{1}{\theta_2}$	$\left\{ \begin{array}{l} 0 < \theta_1 \leq 2 \\ \theta_2 < 0 \\ 2 < \theta_1 \leq 25 \\ \theta_1 + 2\theta_2 \leq 2 \end{array} \right.$

and their nonconvex nature is clearly shown; in Figure 9, the entire final parametric space is presented.

This example was implemented in GAMS 24.4.1 (GAMS Development Corporation. GAMS version 24.4.1. 2015) using the commercial solver CPLEX 12.6.1 for evenly distributed parametric points of the 3D space to evaluate the correctness of the proposed methodology compared to the one by L&I and it was clearly illustrated that the proposed methodology indeed computes exact nonconvex CRs; especially for CR₁ and CR₄. Note that the results computed complement the argument of Theorem 1 about the continuity of the optimiser and the CRs and this can be envisaged in Figure 10, where the discontinuous CR₄ at $\theta_3=1$ is “joined” by CR₂ and thus the optimiser of CR₄ is continuous $\forall \theta \in CR_4$ but not continuous for $\theta_3=1$.

Case study

Thermal cracker. This problem is adapted from Edgar et al.³⁵ and deals with the maximisation of profit under

uncertain cost of propane (θ_1), cracker capacity (θ_3) while LHS is involved in the stoichiometric coefficient of DNG (θ_2). The problem includes 7 optimisation variables, 13 constraints and is formulated as an LP. In Table 14, the nomenclature of the case study is available. The uncertain set Θ is defined in Table 15 while an illustration of the various flows and the final olefins of the thermal cracker is given in Figure 11. The rest of the data can be found in Edgar et al.³⁵

The corresponding multi-parametric programming problem is given by Eqs. 64–72

$$z(\theta_1, \theta_2, \theta_3) = \min_x 2.84x_1 - \theta_1x_2 - 3.33x_3 + 1.09x_4 + 9.39x_5 + 9.51x_6 \tag{64}$$

subject to

$$1.1x_1 + 0.9x_2 + 0.9x_3 + \theta_2x_4 + 1.1x_5 + 0.9x_6 \leq 200,000 \tag{65}$$

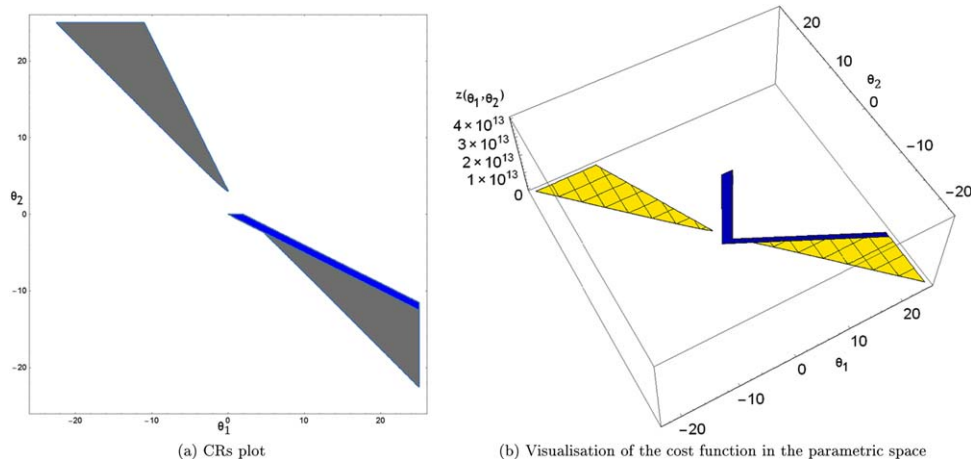

Figure 7. Visual representation of the final results for Example 4.

[Color figure can be viewed at wileyonlinelibrary.com]

Table 13. Results of Global mp-LP

i	z_i	CR_i	z_i (L&I)	CR_i (L&I)
1	0	$\begin{cases} 0 \leq \theta_1 \leq 5 \\ 0 \leq \theta_2 \leq 5 \\ -5 \leq \theta_3 \leq 5 \end{cases}$	0	$\begin{cases} -5 \leq \theta_1 \leq 0 \\ -1 \leq \theta_2 \leq 5 \\ \theta_1 \theta_3 \geq -1 \end{cases}$
2	θ_1	$\begin{cases} -5 \leq \theta_1 \leq -\frac{1}{5} \\ -1 \leq \theta_2 \leq 5 \\ -5 \leq \theta_3 \leq -\frac{1}{\theta_1} \end{cases}$	θ_1	$\begin{cases} 0 \leq \theta_1 \leq 5 \\ -1 \leq \theta_2 \leq 0 \\ -5 \leq \theta_3 \leq 5 \end{cases}$
3	$-\theta_1 \theta_2$	$\begin{cases} -\frac{1}{5} \leq \theta_1 \leq 0 \\ -1 \leq \theta_2 \leq 5 \\ -5 \leq \theta_3 \leq 5 \end{cases}$	$-\theta_1 \theta_2$	$\begin{cases} 0 \leq \theta_1 \leq 5 \\ 0 \leq \theta_2 \leq 5 \\ -5 \leq \theta_3 \leq 5 \end{cases}$
4	$\frac{1+\theta_1+\theta_2+\theta_1\theta_2\theta_3}{1-\theta_3}$	$\begin{cases} 0 \leq \theta_1 \leq 5 \\ -1 \leq \theta_2 \leq 0 \\ -5 \leq \theta_3 \leq 5 \end{cases}$	$\frac{1+\theta_1+\theta_2+\theta_1\theta_2\theta_3}{1-\theta_3}$	$\begin{cases} 0 \leq \theta_1 \leq 5 \\ -5 \leq \theta_2 \leq -1 \\ 1 \leq \theta_3 \leq 5 \end{cases}$
		$\begin{cases} -5 \leq \theta_1 \leq -1 \\ -1 \leq \theta_2 \leq 5 \\ -\frac{1}{\theta_1} \leq \theta_3 < 1 \end{cases}$		
		$\begin{cases} -1 \leq \theta_1 \leq -\frac{1}{5} \\ -5 \leq \theta_2 \leq -1 \\ 1 < \theta_3 \leq -\frac{1}{\theta_1} \end{cases}$		
		$\begin{cases} -\frac{1}{5} \leq \theta_1 \leq 5 \\ -5 \leq \theta_2 \leq -1 \\ 1 < \theta_3 \leq 5 \end{cases}$		

$$0.5x_1 + 0.35x_2 + 0.25x_3 + 0.25x_4 + 0.5x_5 + 0.35x_6 \leq 100,000 + \theta_3 \quad (66)$$

$$0.01x_1 + 0.15x_2 + 0.15x_3 + 0.18x_4 + 0.01x_5 + 0.15x_6 \leq 20,000 \quad (67)$$

$$0.4x_1 + 0.06x_2 + 0.04x_3 + 0.05x_4 - 0.6x_5 + 0.06x_6 = 0 \quad (68)$$

$$0.1x_2 + 0.01x_3 + 0.01x_4 - 0.9x_6 = 0 \quad (69)$$

$$-6857.6x_1 + 364x_2 + 2032x_3 - 1145x_4 - 6857.6x_5 + 364x_6 + 21,520x_7 = 20,000,000 \quad (70)$$

$$x_i \geq 0, \forall i=1, \dots, 7 \quad (71)$$

$$\theta_q \in \Theta, \forall q=1, \dots, 3 \quad (72)$$

The solution of the problem results initially in 220 candidate solutions. Qualifying with primal and dual feasibility conditions, from the 220 candidate solutions only seven are feasible

and for these the procedure to identify overlaps is followed so as to store at the end only the globally optimal solutions. The initial feasible CRs are given in Table 16.

Notice that CR_2 and CR_3 are CRs defined by symmetric solutions and that leads to identical CRs and identical costs; therefore, from the two only one is stored for further investigation. After the dominance test, a number of CRs were found to overlap and within the common space their associated costs are identical. This phenomenon, can be attributed to the non-convex nature of the problem. Again, it is up to the decision maker to decide in such case what should be done but in the present article for purposes of clarity we chose to keep these overlaps as extra CRs where the available information is stored while removing the overlap from the corresponding CRs. In Table 17, the final CRs of the optimal operation for the thermal cracker are presented while the notation $CR_i CR_j$ is used to denote the new CR that corresponds to the overlap of CR_i with CR_j . More specifically, $CR_1 CR_6$ denotes the overlap of CR_1 and CR_6 where $z_1(\theta) = z_6(\theta), \forall \theta \in CR_1 CR_6$, which is practically the entire original CR_1 in the present example; the

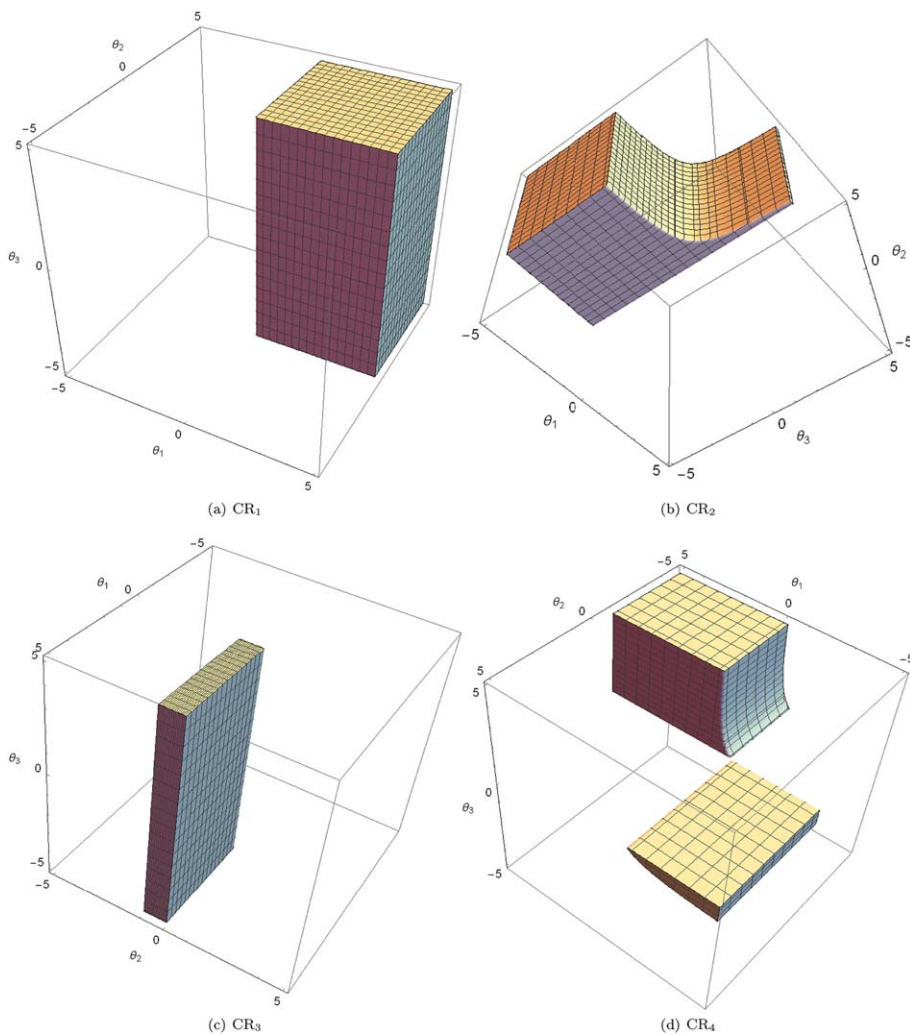

Figure 8. Separate critical regions of the global mp-LP.
 [Color figure can be viewed at wileyonlinelibrary.com]

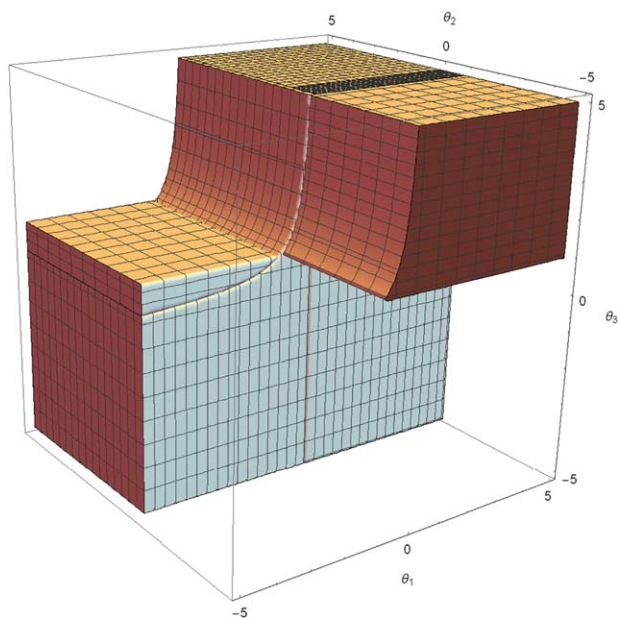

Figure 9. Critical regions of the global mp-LP (example 5).
 [Color figure can be viewed at wileyonlinelibrary.com]

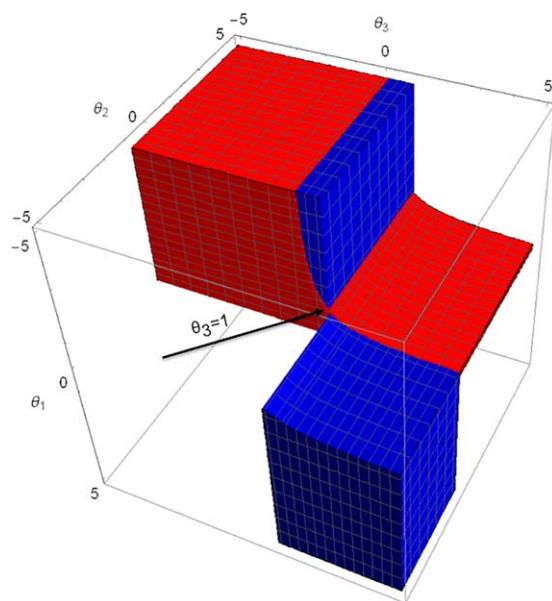

Figure 10. Discontinuous instance for Example 5.
 [Color figure can be viewed at wileyonlinelibrary.com]

Table 14. Nomenclature of the Thermal Cracker Case Study

x_1	Fresh ethane feed (lb/h)
x_2	Fresh propane feed (lb/h)
x_3	Gas-oil feed (lb/h)
x_4	DNG feed (lb/h)
x_5	Ethane recycle (lb/h)
x_6	Propane recycle (lb/h)
x_7	Fuel added (lb/h)

Table 15. Uncertain Set of Case Study

$\theta_1 \in [0, 6]$
$\theta_2 \in [0, 1.5]$
$\theta_3 \in [-50000, 50000]$

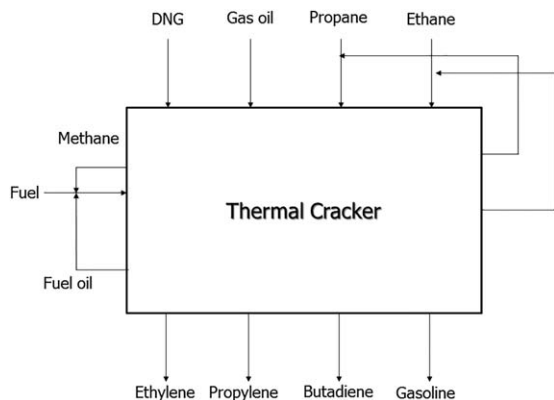

Figure 11. Thermal cracker.

Table 16. Initial Feasible CRs of Case Study

CR_1	$:= \begin{cases} 0 \leq \theta_1 \leq 6 \\ 1.37(0.27+0.0147\theta_1) \leq \theta_2 \leq 1.5 \\ -9090 \leq \theta_3 \leq 50000 \end{cases}$
CR_2	$:= \begin{cases} 0 \leq \theta_1 \leq 6 \\ 0 \leq \theta_2 \leq 1.5 \\ -50000 \leq \theta_3 \leq -9090 \end{cases}$
CR_3	$:= \begin{cases} 0 \leq \theta_1 \leq 6 \\ 0 \leq \theta_2 \leq 1.5 \\ -50000 \leq \theta_3 \leq -9090 \end{cases}$
CR_4	$:= \begin{cases} 0 \leq \theta_1 \leq 6 \\ 0.298 \leq \theta_2 \leq 2.2(0.167+0.00917\theta_1) \\ -9090 \leq \theta_3 \leq 50000 \end{cases}$
CR_5	$:= \begin{cases} 0 \leq \theta_1 \leq 6 \\ 0.298 \leq \theta_2 \leq 1.5 \\ -9090 \leq \theta_3 \leq 50000 \end{cases}$
CR_6	$:= \begin{cases} 0 \leq \theta_1 \leq 6 \\ 0 \leq \theta_2 \leq 2.61(0.141+0.00771\theta_1) \\ \theta_3 = -9090 \end{cases}$
CR_7	$:= \begin{cases} 0 \leq \theta_1 \leq 6 \\ 0 \leq \theta_2 \leq 0.2977 \\ -9090 \leq \theta_3 \leq \frac{-7.14 \times 10^7 + 2.03 \times 10^8 \theta_2}{-4.49 \times 10^3 + 225 \theta_2} \end{cases}$

same happens with CR_4CR_5 and CR_4 . Finally, as the explicit solutions for CR_4CR_5 and CR_5 and CR_1CR_6 are identical and the regions are connected, we can further reduce the number of CRs by two if we merge these two CRs into one big; the postprocessed results for the CRs are given in Table while the corresponding optimal explicit solutions in Table 18.

Discussion

Having demonstrated the applicability of the proposed algorithm for general mp-LPs with global uncertainty, in this section computational aspects and limitations will briefly be discussed.

Table 17. Critical Regions of the Thermal Cracker Case Study

(a) Final CRs of the Thermal Cracker Case Study	
CR_1CR_6	$:= \begin{cases} 0 \leq \theta_1 \leq 6 \\ 0.368+0.0201\theta_1 \leq \theta_2 \leq 1.5 \\ -9090 \leq \theta_3 \leq 50000 \end{cases}$
CR_2	$:= \begin{cases} 0 \leq \theta_1 \leq 6 \\ 0 \leq \theta_2 \leq 1.5 \\ -50000 \leq \theta_3 \leq -9090 \end{cases}$
CR_4CR_5	$:= \begin{cases} 0 \leq \theta_1 \leq 6 \\ 0.298 \leq \theta_2 \leq 0.368+0.0201\theta_1 \\ -9090 \leq \theta_3 \leq 50000 \end{cases}$
CR_5	$:= \begin{cases} 0 \leq \theta_1 \leq 6 \\ 0.368+0.0201\theta_1 \leq \theta_2 \leq 1.5 \\ -9090 \leq \theta_3 \leq 50000 \end{cases}$
CR_6	$:= \begin{cases} 0 \leq \theta_1 \leq 6 \\ 0 \leq \theta_2 \leq 0.368+0.0201\theta_1 \\ \theta_3 = -9090 \end{cases}$
CR_7	$:= \begin{cases} 0 \leq \theta_1 \leq 6 \\ 0 \leq \theta_2 \leq 0.2977 \\ -9090 \leq \theta_3 \leq \frac{-7.14 \times 10^7 + 2.03 \times 10^8 \theta_2}{-4.49 \times 10^3 + 225 \theta_2} \end{cases}$
(b) Postprocessed Results for Final CRs of the Thermal Cracker Case Study	
CR_1^{fin}	$:= \begin{cases} 0 \leq \theta_1 \leq 6 \\ 0.2977 \leq \theta_2 \leq 1.5 \\ -9090 \leq \theta_3 \leq 50000 \end{cases}$
CR_2^{fin}	$:= \begin{cases} 0 \leq \theta_1 \leq 6 \\ 0 \leq \theta_2 \leq 1.5 \\ -50000 \leq \theta_3 \leq -9090 \end{cases}$
CR_3^{fin}	$:= \begin{cases} 0 \leq \theta_1 \leq 6 \\ 0 \leq \theta_2 \leq 0.368+0.0201\theta_1 \\ \theta_3 = -9090 \end{cases}$
CR_4^{fin}	$:= \begin{cases} 0 \leq \theta_1 \leq 6 \\ 0 \leq \theta_2 \leq 0.2977 \\ -9090 \leq \theta_3 \leq \frac{-7.14 \times 10^7 + 2.03 \times 10^8 \theta_2}{-4.49 \times 10^3 + 225 \theta_2} \end{cases}$

Table 18. Explicit Solutions of the Thermal Cracker Case Study

Solution No.	x_1
if $[\theta_1, \theta_2, \theta_3] \in CR_1^{\text{fin}}$ then	$\begin{cases} x_1 = 109000 \\ x_2 = 0 \\ x_3 = 0 \\ x_4 = 0 \\ x_5 = 72700 \\ x_6 = 0 \\ x_7 = 58900 \\ z(\theta) = 993000 \end{cases}$
if $[\theta_1, \theta_2, \theta_3] \in CR_2^{\text{fin}}$ then	$\begin{cases} x_1 = 120000 + 1.2\theta_3 \\ x_2 = 0 \\ x_3 = 0 \\ x_4 = 0 \\ x_5 = 80000 + 0.8\theta_3 \\ x_6 = 0 \\ x_7 = 64700 + 0.637\theta_3 \\ z(\theta) = 109000 + 10.9\theta_3 \end{cases}$
if $[\theta_1, \theta_2, \theta_3] \in CR_3^{\text{fin}}$ then	$\begin{cases} x_1 = \frac{61520 - 1.2\theta_2\theta_3 - 120000\theta_2 + 0.0112\theta_3}{0.563 - \theta_2} \\ x_2 = \frac{0.22\theta_3 + 2000}{\theta_2 - 0.563} \\ x_3 = 0 \\ x_4 = \frac{0.22\theta_3 + 2000}{\theta_2 - 0.563} \\ x_5 = \frac{42500 - 80000\theta_2 + 0.169\theta_3 - 0.8\theta_2\theta_3}{0.563 - \theta_2} \\ x_6 = 0 \\ x_7 = \frac{34762 - 0.6373\theta_2\theta_3 - 64661.7\theta_2 + 0.1781\theta_3}{0.563 - \theta_2} \\ z(\theta) = -\frac{\theta_1(0.22\theta_3 + 2000) + \theta_2(-10.92\theta_3 - 1.092 \times 10^6) + 4.0148\theta_3 + 595404}{\theta_2 - 0.563} \end{cases}$
if $[\theta_1, \theta_2, \theta_3] \in CR_4^{\text{fin}}$ then	$\begin{cases} x_1 = \frac{58720 - 1.2\theta_2\theta_3 - 120000\theta_2 - 0.1235\theta_3}{0.54856 - \theta_2} \\ x_2 = 0 \\ x_3 = 0 \\ x_4 = \frac{2.2\theta_3 + 20000}{0.54856 - \theta_2} \\ x_5 = \frac{37457.8 - 0.8\theta_2\theta_3 - 80000\theta_2 - 0.268\theta_3}{0.54856 - \theta_2} \\ x_6 = \frac{0.0244\theta_3 + 222.22}{0.54856 - \theta_2} \\ x_7 = \frac{33294.7 - 0.6373\theta_2\theta_3 - 64661.7\theta_2 + 0.11027\theta_3}{0.54856 - \theta_2} \\ z(\theta) = -\frac{\theta_2(-10.92\theta_3 - 1.092 \times 10^6) + 3.2514\theta_3 + 574124}{\theta_2 - 0.54856} \end{cases}$

Scalability of the proposed algorithm

The case studies tested so far are of small to medium size due to limitations in terms of number of variables and constraints. The way the analytical solution of the KKT system is

calculated is based on the principles of commutative algebra and algebraic geometry, for example, Groebner Bases theory. The number of optimisation variables and equations tends to rapidly increase the initial number of candidate solutions and

Table 19. Computational Statistics for the Examples Presented

Example	No. of Variables	No. of Constraints	No. of Parameters	CPU (s)
1	4	6	1	0.835
2	3	5	1	0.687
3a	2	5	2	2.452
3b	2	5	7	2.645
4	2	4	2	1.245
5	4	6	3	5.635
6	7	13	3	69.546

thus demanding more computational effort. An interesting observation during the tests of the proposed algorithm is the symmetry involved in the initial candidate solutions and exploiting this symmetry, through an early elimination of symmetric solutions, would probably benefit the scalability of the proposed algorithm. Conversely, the algorithm does not scale at all with the number of uncertain parameters involved in the problem which is a significant feature from a multi-parametric programming point of view. This is because, when solving the problem, the uncertain parameters are treated as symbols and thus no computational power is consumed on the dimensionality of the uncertain vector. Finally, as observed from the results throughout the article, computer algebra systems tend to spend a considerable amount of memory and computational time for the precision of the results; this problem is also known in the literature of symbolic computations as the “floating point format problem.”³⁶ As the algorithm presented herein was implemented in Mathematica 10,³⁷ such decisions were beyond the scope of the article but constitute an observation that may optimise the performance of a custom-made implementation of the algorithm. Overall, in Table 19, for the examples considered their computational statistics are given.

Dimensionality of the LHS parameters

As discussed in Theorem 1, when LHS uncertain parameters are involved the global explicit optimisers, the Lagrange multipliers and the optimal parametric objective function are in principle fractional polynomial functions of the uncertain parameters. It was observed that the order of the power-products in these functions, increases linearly with the number of uncertain parameters on the LHS. The main bottleneck in that case is the computation of the corresponding CRs. As it is demonstrated in Appendix, the computation of the CRs involves the definition of redundant constraints, overlapping CRs and finally the computation of the final nonoverlapping CRs, if necessary. Identifying redundant constraints and defining CRs is in general a very challenging task especially for nonconvex problems as the one that this work deals with; a possible way to overcome this issue could be an inclusion of a postprocessing step where the parametric solutions, for which the CRs could not be defined offline, are evaluated and compared point-wise when the uncertainty occurs. Note that despite the computational burden involved in the definition of CRs, the explicit functions can be computed with relative ease and an extra step for online application could be an attractive alternative to the solution of a nonconvex NLP.

Concluding remarks and future research directions

In this work, we presented a novel algorithm for the solution of general mp-LPs that are subject to global uncertainty. Our main motivation was the extended existence of uncertainty in

optimisation problems either in the extrinsic data of the system, for example, demands, resources availability, prices, and so forth. that lead mostly to RHS and OFC uncertainty but also intrinsic data of the system such as stoichiometric coefficients or transition times in a scheduling problem. Multi-parametric programming can handle, nowadays, uncertainty on the RHS and OFC but the main bottleneck is when uncertainty is present on the LHS and to address this was the main aim of this article.

We presented through a number of case studies the applicability and generality of the proposed framework as well as some instances that the proposed framework outperforms in accuracy and/or computational complexity than other proposed algorithms in the literature. Using symbolic manipulation software to analytically solve the square system of equations derived by the KKT conditions, the exact solution of the general mp-LPs was computed together with the corresponding nonconvex CRs.

Nonetheless, we should report that despite the merits of this work, its applicability at the moment is highly dependent upon the mathematical software used to conduct the calculations and as a result the size of problems that can be solved are of small to medium scale; note that for the case of LHS in mp-P problems only small size problems have been solved because of the computational complexity involved. As next steps, we aim to further improve the performance of the proposed algorithm so it can facilitate large-scale problems.

Acknowledgments

The authors gratefully acknowledge financial support from EPSRC grants EP/M027856/1 and EP/M028240/1.

Literature Cited

- Sahinidis N. Optimization under uncertainty: state-of-the-art and opportunities. *Comput Chem Eng.* 2004;28(6):971–983.
- Birge J, Louveaux F. *Introduction to Stochastic Programming.* New York: Springer-Verlag, 2011.
- Ben-Tal A, Nemirovski A. Robust solutions of uncertain linear programs. *Oper Res Lett.* 1999;25(1):1–13.
- Ben-Tal A, Nemirovski A. Robust optimization—methodology and applications. *Math Prog.* 2002;92(3):453–480.
- Soyster A. Convex programming with set-inclusive constraints and applications to inexact linear programming. *Oper Res.* 1973;21(5):1154–1157.
- Bertsimas D, Sim M. The price of robustness. *Oper Res.* 2004;52(1):35–53.
- Pistikopoulos EN. Perspectives in multi-parametric programming and explicit model predictive control. *AIChE J.* 2009;55(8):1918–1925.
- Charitopoulos VM, Dua V. A unified framework for model-based multi-objective linear process and energy optimisation under uncertainty. *Appl Energy.* 2017;186:539–548.
- Patrinos P, Sarimveis H. A new algorithm for solving convex parametric quadratic programs based on graphical derivatives of solution mappings. *Automatica.* 2010;46(9):1405–1418.
- Saaty TL, Gass SI. Parametric objective function (Part 1). *J Oper Res.* 1954;2(3):316–319.
- Gass SI, Saaty TL. The computational algorithm for the parametric objective function. *Nav Res Logist Q.* 1955;2(1-2):39–45.
- Gass SI, Saaty TL. Parametric objective function (Part 2) - generalization. *J Oper Res.* 1955;3(4):395–401.
- Gal T, Nedoma J. Multi-parametric linear programming. *Manag Sci.* 1972;18(7):406–422.
- Gal T. RIM multi-parametric linear programming. *Manag Sci.* 1975;21(5):567–575.
- Yuf P, Zeleny M. Linear multi-parametric programming by multicriteria simplex method. *Manag Sci.* 1976;23(2):159–170.
- Schechter M. Polyhedral functions and multi-parametric linear programming. *J Optim Theory Appl.* 1987;53(2):269–280.
- Borrelli F, Bemporad A, Morari M. Geometric algorithm for multi-parametric linear programming. *J Optim Theory Appl.* 2003;118(3):515–540.

18. Filippi C. An algorithm for approximate multi-parametric linear programming. *J Optim Theory Appl.* 2004;120(1):73–95.
19. Jones CN, Morrari M. Multi-parametric linear complementarity problems. In: *45th IEEE Conference on Decision and Control*. San Diego, CA, USA: IEEE, 2006:5687–5692.
20. Greenberg HJ. The use of the optimal partition in a linear programming solution for postoptimal analysis. *Oper Res Lett.* 1994;15(4):179–185.
21. Hladík M. Multi-parametric linear programming: support set and optimal partition invariance. *Eur J Oper Res.* 2010;202(1):25–31.
22. Gal T. *Postoptimal Analyses, Parametric Programming and Related Topics*. Berlin: Walter de Gruyter, 1995.
23. Li Z, Ierapetritou MG. A new methodology for the general multi-parametric mixed-integer linear programming (MILP) problems. *Ind Eng Chem Res.* 2007;46(15):5141–5151.
24. Wittmann-Hohlbein M, Pistikopoulos EN. On the global solution of multi-parametric mixed integer linear programming problems. *J Global Optim.* 2012;57(1):51–73.
25. Wittmann-Hohlbein M, Pistikopoulos EN. A two-stage method for the approximate solution of general multi-parametric mixed-integer linear programming problems. *Ind Eng Chem Res.* 2012;51(23):8095–8107.
26. Khalilpour R, Karimi I. Parametric optimization with uncertainty on the left hand side of linear programs. *Comput Chem Eng.* 2014;60:31–40.
27. Flavell R, Salkin GR. An approach to sensitivity analysis. *Oper Res Q.* 1975;26(4):857–866.
28. Henderson HV, Searle SR. On deriving the inverse of a sum of matrices. *SIAM Rev.* 1981;23(1):53–60.
29. Charitopoulos VM, Dua V. Explicit model predictive control of hybrid systems and multi-parametric mixed integer polynomial programming. *AIChE J.* 2016;62(9):3441–3460.
30. Bellman R. *Introduction to Matrix Analysis*, Vol. 19. SIAM, 1997.
31. Bochnak J, Coste M, Roy MF. *Real Algebraic Geometry*, Vol. 36. New York: Springer-Verlag, 2013.
32. Pistikopoulos EN, Georgiadis MC, Dua V. *Multi-Parametric Programming*. Weinheim, Germany: Wiley-VCH, 2007.
33. Dinkelbach W. Sensitivitätsanalysen und parametrische Programmierung. *J Appl Math Mech.* 1970;50(6):434–435.
34. Buchberger B, Winkler F. *Gröbner Bases and Applications*, Vol. 251. Cambridge, United Kingdom: Cambridge University Press, 1998.
35. Edgar TF, Himmelblau DM, Lasdon LS. *Optimization of Chemical Processes*. New York: McGraw-Hill, 2001.
36. Fousse L, Hanrot G, Lefèvre V, Pélissier P, Zimmermann P. MPFR: a multiple-precision binary floating-point library with correct rounding. *ACM Trans Math Softw.* 2007;33(2):13.
37. Wolfram Research, Inc. *Mathematica*, Version 10.0. Champaign, Illinois: Wolfram Research, Inc., 2014.
38. Acevedo J, Pistikopoulos EN. An algorithm for multi-parametric mixed-integer linear programming problems. *Oper Res Lett.* 1999;24(3):139–148.
39. Bemporad A, Morari M, Dua V, Pistikopoulos EN. The explicit linear quadratic regulator for constrained systems. *Automatica.* 2002;38(1):3–20.
40. Tøndel P, Johansen T, Bemporad A. An algorithm for multi-parametric quadratic programming and explicit MPC solutions. *Automatica.* 2003;39(3):489–497.
41. Gupta A, Bhartiya S, Nataraj P. A novel approach to multi-parametric quadratic programming. *Automatica.* 2011;47(9):2112–2117.
42. Benson H. Algorithms for parametric nonconvex programming. *J Optim Theory Appl.* 1982;38(3):319–340.
43. Johansen T. On multi-parametric nonlinear programming and explicit nonlinear model predictive control. In: *IEEE conference on decision and control*, Vol. 3. IEEE, 2002:2768–2773.
44. Acevedo J, Salgueiro M. An efficient algorithm for convex multi-parametric nonlinear programming problems. *Ind Eng Chem Res.* 2003;42(23):5883–5890.
45. Johansen T. Approximate explicit receding horizon control of constrained nonlinear systems. *Automatica.* 2004;40(2):293–300.
46. Fotiou IA, Rostalski P, Parrilo PA, Morari M. Parametric optimization and optimal control using algebraic geometry methods. *Int J Control.* 2006;79(11):1340–1358.
47. Dominguez LF, Narciso DA, Pistikopoulos EN. Recent advances in multi-parametric nonlinear programming. *Comput Chem Eng.* 2010;34(5):707–716.
48. Pertsinidis A, Grossmann IE, McRae G. Parametric optimization of MILP programs and a framework for the parametric optimization of MINLPs. *Comput Chem Eng.* 1998;22:205–212.
49. Dua V, Pistikopoulos EN. An algorithm for the solution of multi-parametric mixed integer linear programming problems. *Ann Oper Res.* 2000;99(1-4):123–139.
50. Jia Z, Ierapetritou MG. Uncertainty analysis on the righthand side for MILP problems. *AIChE J.* 2006;52(7):2486–2495.
51. Mitsos A, Barton PI. Parametric mixed-integer 0-1 linear programming: the general case for a single parameter. *Eur J Oper Res.* 2009;194(3):663–686.
52. Oberdieck R, Wittmann-Hohlbein M, Pistikopoulos EN. A branch and bound method for the solution of multi-parametric mixed integer linear programming problems. *J Global Optim.* 2014;59(2-3):527–543.
53. Dua V, Bozinis N, Pistikopoulos EN. A multi-parametric programming approach for mixed-integer quadratic engineering problems. *Comput Chem Eng.* 2002;26(4):715–733.
54. Oberdieck R, Pistikopoulos EN. Explicit hybrid model-predictive control: the exact solution. *Automatica.* 2015;58:152–159.
55. Dua V, Pistikopoulos EN. An outer-approximation algorithm for the solution of multi-parametric MINLP problems. *Comput Chem Eng.* 1998;22:955–958.
56. Dua V, Pistikopoulos EN. Algorithms for the solution of multi-parametric mixed-integer nonlinear optimization problems. *Ind Eng Chem Res.* 1999;38(10):3976–3987.
57. Dua V, Papalexandri K, Pistikopoulos EN. Global optimization issues in multi-parametric continuous and mixed-integer optimization problems. *J Global Optim.* 2004;30(1):59–89.

Appendix

Comparison Procedure for the Dominance Criterion

Defining redundant constraints and computing the new CRs within the comparison procedure is a nontrivial task, especially for nonconvex problems. A comparison procedure for parametric solutions valid in the same parametric space can be found in Acevedo and Pistikopoulos,³⁸ so as to keep only the one that provides the better solution (dominance criterion). For the case of convex CRs, that is, when the CRs are defined as a set of linear inequality constraints. In general, while solving a mp-LP problem under global uncertainty it can happen that two different parametric solutions, that is, $z_1(\theta)$ and $z_2(\theta)$ to be feasible in the same parametric space. The comparison procedure aims to identify the regions were

$$z_1(\theta) - z_2(\theta) \leq 0 \quad (\text{A1})$$

and

$$z_2(\theta) - z_1(\theta) \leq 0 \quad (\text{A2})$$

given that $z_1(\theta)$ is valid in CR_1 and $z_2(\theta)$ is valid in CR_2 . The first step is to compute $\text{CR}_{\text{INT}} = \text{CR}_1 \cap \text{CR}_2$.

Computation of CR_{INT} and Redundant Constraints

Excluding the case that $\text{CR}_{\text{INT}} = \emptyset$ there are three possible outcomes in the definition of the CR_{INT} which are described in Table A1

In Figure A1, the different cases for the definition of the CR_{INT} can be envisaged.

For illustration purposes assume that the following two randomly generated CRs, given by Eqs. A3–A4, are under examination. We have chosen to illustrate a case that two nonconvex CRs overlap and the CR_{INT} is nonconvex as well, to underline the salient feature of the proposed algorithm, that is, computing exact nonconvex CRs.

Table A1. Possible Outcomes in the Definition of CR_{INT}

Case 1	$\text{CR}_1 \subseteq \text{CR}_2$ which means that all constraints of CR_2 are redundant and $\text{CR}_{\text{INT}} = \text{CR}_1$
Case 2	$\text{CR}_1 \supseteq \text{CR}_2$ which means that all constraints of CR_1 are redundant and $\text{CR}_{\text{INT}} = \text{CR}_2$
Case 3	The CR_{INT} is defined by a set of active constraints from both CR_1 and CR_2 as both CRs have some nonredundant constraints

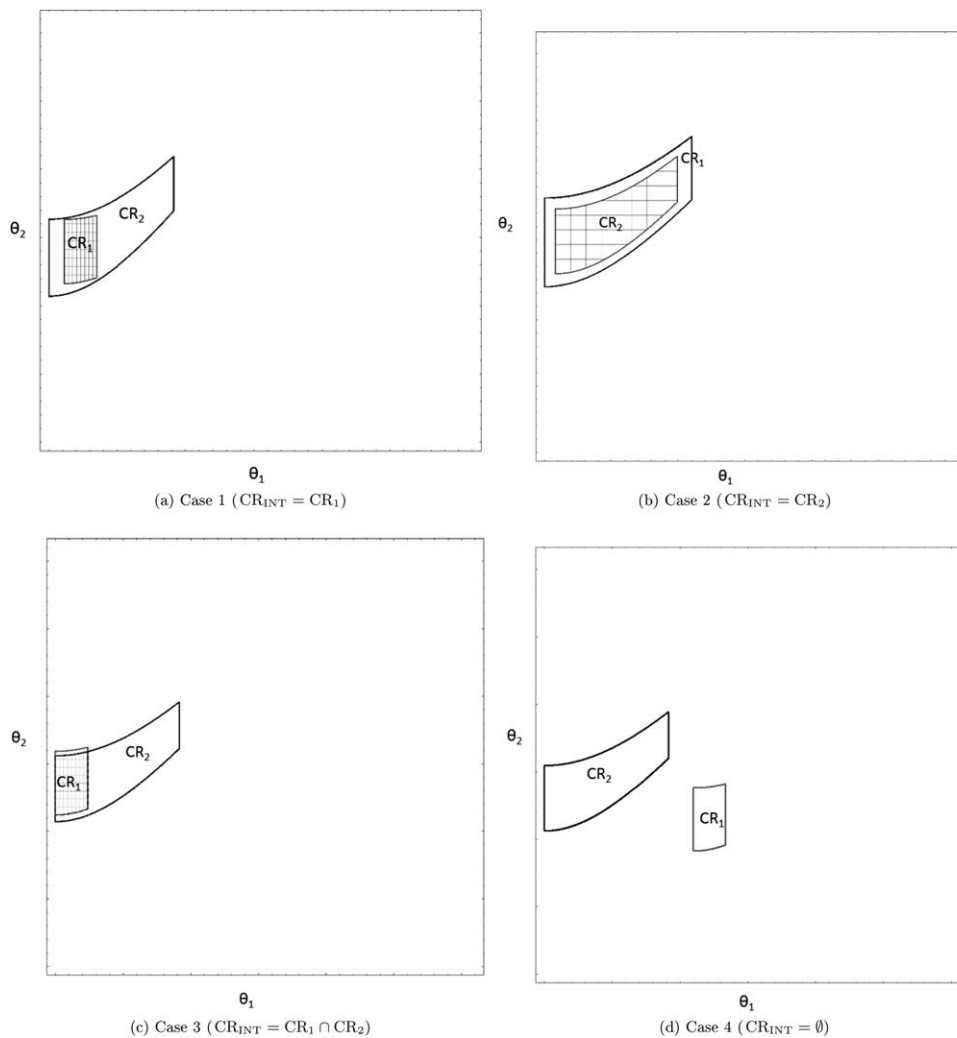

Figure A1. Definition of CR_{INT} .

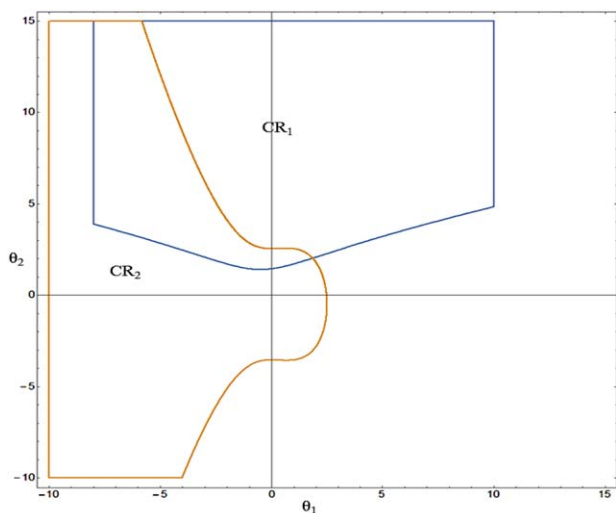

Figure A2. CR_1 and CR_2 in the parametric space.

[Color figure can be viewed at wileyonlinelibrary.com]

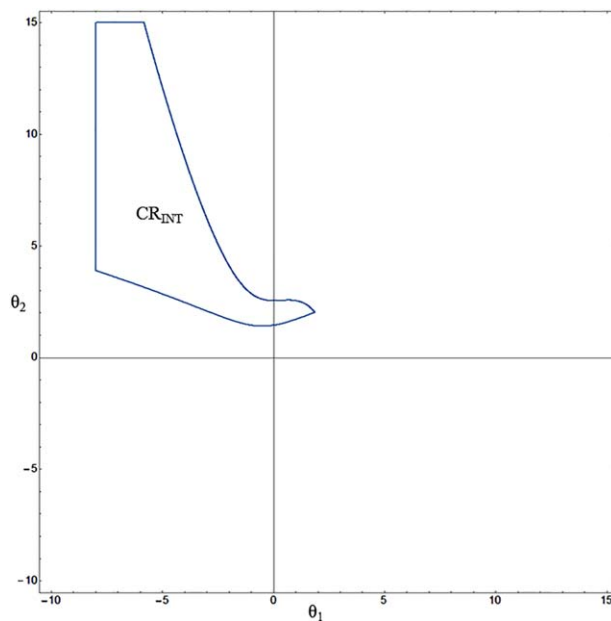

Figure A3. CR_{INT} in the parametric space.

[Color figure can be viewed at wileyonlinelibrary.com]

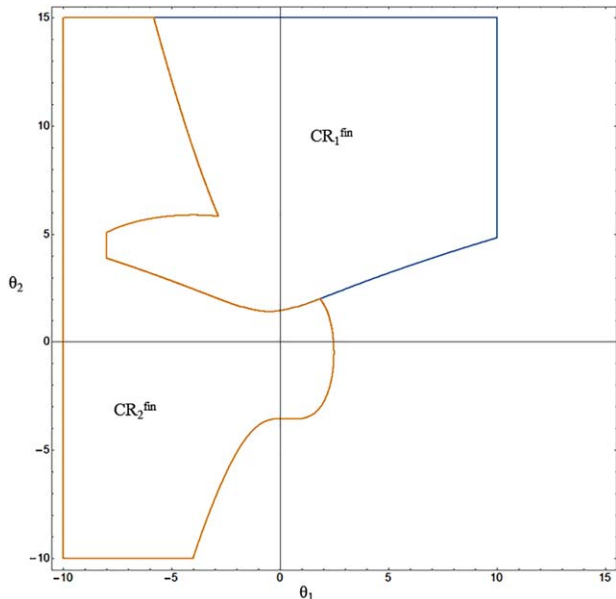

Figure A4. Final nonoverlapping CRs in the parametric space.

[Color figure can be viewed at wileyonlinelibrary.com]

$$CR_1 = \begin{cases} -8 \leq \theta_1 \leq 10 \\ \theta_2^3 > \theta_1 + \theta_1^2 + 3 \end{cases} \quad (A3)$$

$$CR_2 = \begin{cases} -10 \leq \theta_1 \leq 5 \\ \theta_2^2 + \theta_2 < 9 - \theta_1^3 + \theta_1^2 \end{cases} \quad (A4)$$

Graphically, in the parametric space CR_1 and CR_2 are presented in Figure A2. These two CRs are nonpolyhedral and the inequalities defining the CRs are polynomial. As mentioned above, in this work Mathematica was used for the analytic solution of the mp-LP under global uncertainty. Specifically, for the comparison procedure the command “Reduce” was used. “Reduce” is a command in Mathematica that qualifies sets of conditional arguments within a given set of parameters and computes a new set within which these conditional statements are satisfied. For example, in the definition of the intersection of two CRs (CR_{INT}), “Reduce” identifies the redundant constraints of both CRs and computes the region of parametric space where both CRs exists; for the case that the CRs

do not overlap the output of “Reduce” is a “False” statement equivalent to the argument $CR_{INT} = \emptyset$.

In this illustrative case using “Reduce” the CR_{INT} is computed and the redundant inequalities from the two CRs are automatically removed from the set of inequalities forming the CR_{INT} , which is given mathematically by condition (A5) and graphically presented in Figure A3; the CR_{INT} as expected is nonpolyhedral.

$$CR_{INT} = \begin{cases} -8 \leq \theta_1 \leq 1.84742 \\ \theta_2 \geq -\theta_1 - \theta_1^2 + \theta_1^3 - 3 \\ \theta_2 \leq -0.5 + 0.5\sqrt{37 + 4\theta_1^2 - 4\theta_1^3} \end{cases} \quad (A5)$$

The redundant constraints from each CR can be computed as

$$RC_{CR_i} = \{\theta \mid \theta \in (CR_i \wedge (-CR_{INT}))\}, \forall i=1, 2 \quad (A6)$$

using Mathematica.

Computation of CR_{REST} and the Final Nonoverlapping CRs

After the definition of the CR_{INT} dominance criterion can be expressed by the conditional inequality (A7).

$$z_1(\theta) - z_2(\theta) \leq 0, \theta \in CR_{INT} \quad (A7)$$

As a next step, excluding the case that $CR_{INT} = \emptyset$, the comparison procedure is continued and a new set of conditional statements is qualified, given by Eq. A7. The output of this step is used so as to define the CR_{REST_1} , given by Eqs. A8–A9, and the two new CRs that satisfy the comparison procedure and no longer overlap.

$$CR_{REST_1} = \{\theta \mid \theta \in (CR_{INT} \wedge (z_1(\theta) \leq z_2(\theta)))\} \quad (A8)$$

$$CR_{REST_2} = \{\theta \mid \theta \in (CR_{INT} \wedge (z_1(\theta) \geq z_2(\theta)))\} \quad (A9)$$

Following the comparison procedure for the previous illustrative case, assume that

$$z_1(\theta) - z_2(\theta) = 0.03\theta_2^4 + \theta_1^2 + 8\theta_1 - 20 \quad (A10)$$

To compute the dominant solution for the illustrative case the “Reduce” command is again used to qualify Eq. A7. The output of the “Reduce” in this case a new set of polynomial inequalities given by Eq. A11, namely CR_{REST_1} ; this is the fraction of CR_{INT} in which $z_1(\theta) \leq z_2(\theta)$

$$CR_{REST_1} = \begin{cases} -8 \leq \theta_1 \leq -2.83459 \\ -2.83459 \leq \theta_1 \leq 2.49087 \end{cases} \quad \begin{cases} \theta_2 \geq -\theta_1 - \theta_1^2 + \theta_1^3 - 3 \\ \theta_2 \leq \sqrt{-2000 + 800\theta_1 + 100\theta_1^2 + \theta_1^4} \end{cases} \quad (A11)$$

Given the mathematical expression of CR_{REST_1} , the fraction of the CR_{INT} where $z_1(\theta) \geq z_2(\theta)$ can be computed evaluating two equivalent conditional expressions given by Eqs. A12–A13. The output of “Reduce” for this evaluation is given mathematically, for the present illustrative case by Eq. A14

$$CR_{REST_2} = \{\theta \mid \theta \in (CR_{INT} \wedge (-CR_{REST_1}))\} \quad (A12)$$

$$CR_{REST_2} = \{\theta \mid \theta \in (CR_{INT} \wedge (z_1(\theta) \geq z_2(\theta)))\} \quad (A13)$$

$$\text{CR}_{\text{REST}_2} = \begin{cases} -8 \leq \theta_1 \leq -2.83459 \\ \theta_2 \geq \sqrt{-2000 + 800\theta_1 + 100\theta_1^2 + \theta_1^4} \\ \theta_2 \leq -0.5 + 0.5\sqrt{37 + 4\theta_1^2 - 4\theta_1^3} \end{cases} \quad (\text{A14})$$

After the CR_{REST} regions are computed the final CRs can be computed as follows

$$\text{CR}_1^{\text{fin}} = \{\theta \mid \theta \in (\text{CR}_1 \wedge (\neg \text{CR}_{\text{REST}_2}))\} \quad (\text{A15})$$

$$\text{CR}_2^{\text{fin}} = \{\theta \mid \theta \in (\text{CR}_2 \wedge (\neg \text{CR}_{\text{REST}_1}))\} \quad (\text{A16})$$

Notice that in the previous step $\text{CR}_{\text{REST}_2}$ could be implicitly computed employing the negative Boolean expressions and not explicitly as done here, alleviating thus the computational effort. Finally, the two CRs that no longer overlap are presented graphically in Figure A4, while their mathematical expression is given by Eqs. A17–A18. Notice that $z_1(\theta)$ is optimal in CR_1^{fin} and $z_2(\theta)$ is optimal in CR_2^{fin}

$$\text{CR}_1^{\text{fin}} = \begin{cases} \begin{cases} -8 \leq \theta_1 \leq -2.83459 \\ \begin{cases} \theta_2 \geq -\theta_1 - \theta_1^2 + \theta_1^3 - 3 \\ \theta_2 \leq \sqrt{-2000 + 800\theta_1 + 100\theta_1^2 + \theta_1^4} \\ \theta_2 \geq -0.5 + 0.5\sqrt{37 + 4\theta_1^2 - 4\theta_1^3} \end{cases} \end{cases} \\ \begin{cases} -2.83459 \leq \theta_1 \leq 10 \\ \theta_2 \geq -\theta_1 - \theta_1^2 + \theta_1^3 - 3 \end{cases} \end{cases} \quad (\text{A17})$$

$$\text{CR}_2^{\text{fin}} = \begin{cases} \begin{cases} -10 \leq \theta_1 \leq -8 \\ \begin{cases} \theta_2 \geq -0.5 + 0.5\sqrt{37 + 4\theta_1^2 - 4\theta_1^3} \\ \theta_2 \leq -0.5 + 0.5\sqrt{37 + 4\theta_1^2 - 4\theta_1^3} \end{cases} \end{cases} \\ \begin{cases} -8 \leq \theta_1 \leq -2.83459 \\ \begin{cases} \begin{cases} \theta_2 \geq -0.5 + 0.5\sqrt{37 + 4\theta_1^2 - 4\theta_1^3} \\ \theta_2 \leq -\theta_1 - \theta_1^2 + \theta_1^3 - 3 \end{cases} \\ \begin{cases} \theta_2 \geq \sqrt{-2000 + 800\theta_1 + 100\theta_1^2 + \theta_1^4} \\ \theta_2 \leq -0.5 + 0.5\sqrt{37 + 4\theta_1^2 - 4\theta_1^3} \end{cases} \end{cases} \end{cases} \\ \begin{cases} -2.83459 \leq \theta_1 \leq 1.84742 \\ \begin{cases} \theta_2 \geq -0.5 + 0.5\sqrt{37 + 4\theta_1^2 - 4\theta_1^3} \\ \theta_2 \leq -\theta_1 - \theta_1^2 + \theta_1^3 - 3 \end{cases} \end{cases} \\ \begin{cases} 1.84742 \leq \theta_1 \leq 2.49087 \\ \begin{cases} \theta_2 \geq -0.5 + 0.5\sqrt{37 + 4\theta_1^2 - 4\theta_1^3} \\ \theta_2 \leq -0.5 + 0.5\sqrt{37 + 4\theta_1^2 - 4\theta_1^3} \end{cases} \end{cases} \end{cases} \quad (\text{A18})$$

Manuscript received Dec. 13, 2016, and revision received Mar. 23, 2017.