

DOI: 10.1002/

Article type: Full Paper

**Quantifying Recombination Losses during Charge Extraction in Bulk Heterojunction
Solar Cells using a Modified Charge Extraction Technique**

*Brendan Wright, Yukihiro Nakajima, Tracey M. Clarke, Kouichi Okuda, Heikki Paananen,
Attila J. Mozer*, Shogo Mori**

B. Wright, Dr. T. M. Clarke, Assoc. Prof. A. J. Mozer
ARC Centre of Excellence for Electromaterials Science
Intelligent Polymer Research Institute
University of Wollongong, Wollongong, NSW 2522
Australia.
Email: attila@uow.edu.au

Y. Nakajima, K. Okuda, Assoc. Prof. S. Mori
Division of Chemistry and Materials, Faculty of Textile Science and Technology, Shinshu
University, Ueda, Nagano 386-8567
Japan
Email: shogmori@shinshu-u.ac.jp

Dr. T. M. Clarke
Department of Chemistry
University College London
London WC1H 0AJ
United Kingdom

H. Paananen

Asamalab

1-29-8 Nakagomi Saku, Nagano, 385-0051

Japan

Keywords: recombination coefficient, lifetime, energy levels, charge transport, mobility

Abstract

A variety of charge extraction (CE) techniques have been developed to measure charge density and recombination coefficients in bulk heterojunction (BHJ) solar cells. Charge recombination during charge extraction as a major limitation of this method has not been systematically quantified. Herein, we report CE measurements using a newly designed fast switch, which enables the application of a reverse bias to the solar cells facilitating charge extraction. With applied reverse bias, more than 40 % increase in the extracted charge was obtained in solar cells with thicker active layers or with fast recombination. The measured charge carrier lifetime increased by up to a factor of three at sufficiently high applied biases (up to 8 V), suggesting significant errors in CE measurements without applied bias. The increased extracted charges with increasing applied bias are attributed to a combination of three cases: i) slightly faster charge extraction due to the larger electric field; ii) increased charge extraction rate at high light intensities when the transients are space charge disturbed; iii) increased charge separated lifetime during charge extraction attributed to the spatial separation of the electron and hole density due to the applied electric field.

1. Introduction

Bulk heterojunction (BHJ) solar cells fabricated from organic materials have been the subject of intensive studies from both academic and commercialisation points of view. Typical organic BHJ solar cells are made from conjugated polymer as electron donor materials and fullerene derivatives as electron acceptor materials. Under light irradiation, excitons are generated and diffuse to electron donor and acceptor materials interface where the electrons or holes are transferred to the electron acceptor or the donor materials, respectively, forming a charge-transfer state. Then the electrons and holes are dissociated and collected at metal and transparent conducting electrodes, respectively. The typical time scale required for the charges to escape geminate recombination is nanosecond to hundreds of nanoseconds.^[1] To obtain high charge collection efficiency, thus, high short circuit current (J_{sc}) and fill factor, charge drift/diffusion length should be longer than the thickness of the active layer.^[2, 3] However, many materials are suffering from slow charge transport and/or fast recombination after surviving from the geminate recombination. Thus, evaluation of charge mobility and recombination lifetime of free charges coupled with understanding the transport and recombination mechanism is important for the development of new materials. The origin of the open circuit voltage (V_{oc}) of BHJ solar cells had been interpreted mostly with the HOMO and LUMO levels of the organic materials.^[4] In addition, the Fermi levels of the donor and acceptor materials under illumination, thus free carrier recombination lifetime, should also influence the V_{oc} . Indeed, Murano et al, reported that charge carrier lifetime was also important parameter determining the V_{oc} .^[5] To study recombination kinetics and material energy levels for dye-sensitized solar cells (DSSCs), a charge extraction technique using a switch was developed by N. W. Duffy et al, and reported in 2000.^[6] In 2008, the technique was applied for organic BHJ solar cells by Shuttle et al.^[7] The measurement is as follows: a solar cell is connected with a switch in series and the

switch is left at open circuit condition under steady light irradiation. The light is turned off and *simultaneously* the switch is turned on resulting in a transient current. The charge density under steady state illumination and open circuit conditions is obtained by integrating the current transient. The measurement can be repeated at various steady state illumination intensities corresponding to various V_{oc} , thus obtaining the charge density as a function of the V_{oc} . The dependency of V_{oc} on charge density can be used to infer the energy levels of the donor / acceptor materials as well as the density and energetics of charge traps. Charge extraction measurements can also be performed by applying a *delay time* between turning off the light and turning on the switch.^[6, 8] In this case, charges recombine during the delay time in the time period between the light is turned off and the switch is turned on. Therefore, ideally, the extracted charge represents charge carriers that survived charge recombination during the delay time. By plotting the extracted charges as a function of delay time, charge recombination lifetime and recombination coefficients can be obtained.

A crucial requirement for the above charge extraction measurement is that no charge recombination should occur during extraction, i.e. after the switch is turned on. For DSSCs, typically such recombination during extraction has not been observed. For a P3HT:PCBM solar cell, the fraction of charges lost due to recombination during charge extraction was estimated to be less than 10 percent.^[7] However, for other BHJ solar cells exhibiting faster recombination, slow transport, or using thick active layers, charge extraction time could be comparable or longer than the recombination lifetime leading to a much more significant underestimation of charge density. Furthermore, space charge limited charge extraction transients as well as RC time constant of the circuit could limit the rate of carrier sweep out and lead to recombination during extraction. Recombination during charge extraction introduces an error to charge density

versus V_{oc} plots and charge carrier lifetime measurements. However, it is not trivial to quantify charge recombination losses in typical CE measurements.

Charge extraction techniques using an externally applied reverse bias have been used for more than three decades to determine charge carrier transport and recombination.^[9] For example, photo-induced charge extraction by linearly increasing voltage (Photo-CELIV) applies a triangular shape reverse bias pulse to facilitate charge extraction.^[10] The application of a linearly increasing voltage ramp helps to subtract the capacitive charging current from the device, but the rate of charge extraction is not as high as using a voltage step. In addition, since the bias voltage increases with time, extraction time is limited by the maximum voltage and voltage increase rate. Indeed, the amount of extracted charges by Photo-CELIV was compared to that by normal CE, that extracts charges at short circuit, showing larger amount by CE.^[8]

____ Typically, a forward bias corresponding to the open circuit voltage of the solar cell is applied in the dark before a short laser pulse hits the sample.^[10] For mobility and lifetime measurements, the forward bias is left on during the delay time until the application of the reverse bias voltage ramp. Neher et al introduced a bias amplified charge extraction (BACE) method, which also generates the open circuit condition by applying a forward bias, but it extracts charges under an applied constant reverse bias.^[11] Facilitated by the larger initial applied electric field during the extraction phase, charge transport was accelerated and the extraction time became faster than the recombination lifetime. The BACE method was therefore better to obtain the charge density versus V_{oc} relationship compared to charge extraction under short circuit conditions. However, this technique, similarly to photo-CELIV described above, has a major limitation for charge carrier lifetime measurements employing a variable time delay between turning off the light and switching from forward to reverse bias. Due to charge

recombination, the open circuit voltage constantly decays, but the forward bias is constant, resulting in charge injection from the contacts to the solar cells' active layer. The charge injection makes it complicate to analyze the lifetime of photo-generated charges.^[12] Furthermore, recent publications claim that photo-generated charge distribution in BHJ solar cells at open circuit condition is not homogeneous and changes with charge density.^[13, 14] The application of a constant forward bias during delay time may change the charge distribution and therefore it could alter the recombination kinetics in comparison to that under open circuit conditions.

Dyakonov et al proposed a technique called open circuit corrected charge carrier extraction (OTRACE) to overcome the problem of constant forward bias during the delay time in photo-CELIV and BACE.^[15] In this measurement, the open circuit voltage decay is first measured and then the same voltage signal is applied as forward bias during the delay time to maintain the open circuit condition for certain time, followed by the application of a reverse bias voltage ramp to extract charges. This technique seems good but experimentally complicated, e.g. matching impedance for measuring Voc decay and applying the bias. In addition, the application of a linearly increasing voltage ramp as opposed to a voltage pulse may lead to long charge extraction time as explained above.

In order to overcome the experimental difficulties of obtaining open circuit condition during delay time *and* to accelerate charge extraction to minimize charge recombination during extraction, here we introduce a modified charge extraction (mCE) measurement by applying reverse bias through a fast switch during charge extraction. Figure 1 shows the experimental setup. We demonstrate the utility of the modified charge extraction method by measuring charge recombination and charge density relationship versus V_{oc} in various BHJ solar cells at different

light intensities and applied bias conditions. We systematically ~~studied~~ tested the ~~benefits~~ effects of charge recombination during extraction on the analysis of recombination kinetics by using the mCE method for BHJ solar cells with thick active layers, and with slow transport and/or fast recombination by changing the morphology by the well-established thermal annealing of P3HT/PCBM solar cells. If the impedance of the switch is not high enough, charges may “leak” to the external circuit. Thus we also examined the effect of different switch off resistance on charge carrier lifetime measurements. We also compare the lifetime and bimolecular recombination coefficient obtained under different reverse bias potentials.

2. Results

The I-V characteristics of all the solar cells are summarized in Figure S1 and Table S1 in the Supporting Information. The cell area was 4.0 mm² and the thickness was between 94 and 207 nm. The highest energy conversion efficiencies of the annealed and as-prepared P3HT/PCBM solar cells under 1 sun conditions were 2.6 and 1.6 %, respectively, using the thinnest active layers (94 nm). Experimentally obtained geometrical capacitances were 1.6, 0.95, and 0.75 nF for 94, 150, 207 nm thick cells, respectively. Figure 2 shows typical current transients obtained by mCE for annealed P3HT:PCBM solar cells. The laser intensity was 100 mW. A reverse bias of 1 V was applied simultaneously when the laser was turned off and the switch was turned on. The same measurement was performed without laser illumination to obtain the capacitive charging current (blue line). In comparison, the black line shows the displacement current due to the switch closing without laser irradiation and without applied bias. The amount of photo-generated charges was obtained by integrating the transient current (green line), obtained by subtracting the dark capacitive charging current (blue) from the extraction current (red line).

Figure 3 shows the effect of applying a reverse bias on the transient current for both annealed and as-prepared P3HT:PCBM solar cells with 94 nm active layer thickness. These transients were obtained by subtracting the capacitive charging current without laser illumination from the current transient with laser illumination. For the annealed P3HT:PCBM solar cells, with increasing bias potential (0 to 8 V), the peak current increased in magnitude, and the time to reach the peak current and the decay time were both shortened. For as-prepared solar cells, the peak current slightly increased in magnitude with increasing applied bias, but not as prominently as for annealed cells. Furthermore, the transient decay time did not change with increasing applied bias.

Figure 4 shows the extracted transient current measured at different laser light intensities and bias potentials for annealed P3HT:PCBM with 94 nm active layer thickness. At lower laser intensity (5 mW), the current peak was almost instantaneous. The integrated photogenerated charge at this laser intensity was 2.1 nC, while the capacitive charge at 2 V applied bias was 3.3 nC. At higher laser intensities (20 mW and 100 mW), the transient current showed an initial rise when bias was applied, whereas it continuously decayed when no external bias was applied. When 2 V was applied, the integrated charges at these laser intensities were 2.8 nC and 4.7 nC respectively, which is 84 % and 139 % of the capacitive charge.

The current transients in Figure 3 and 4 were measured through a 50 Ω R_2 resistor. Based on the impedance of the measured solar cells at 1 MHz, we estimated the solar cell impedance to be approximately 50 Ω . Adding the impedance of the function generator and switch, the total circuit resistance was about 150 Ω . Thus, the RC time constant of the circuit was about 230 ns. To check the effect of the RC time constant on the charge extraction transients, R_2 was changed to 10 Ω , corresponding to an RC time constant of 170 ns. Figure 5 compares the charge

extraction transients using the two different values of R_2 with different applied biases and at 100 mW laser power measured for as prepared P3HT:PCBM solar cells with two different active layer thicknesses (94 nm and 207 nm). Using a 10 Ω resistor led to slightly faster transients, especially for thicker active layer devices. However, faster transients did not lead to increased extracted charge.

The mCE measurements without delay time are expected to result in the same transients as the BACE method described in the introduction. We compared mCE and BACE measurements, confirming that nearly identical transients were obtained using the two techniques. (Figure S2, S.I.).

The amount of extracted charges in Figure 3 and 4 increased with applied bias potential. Figure 6 shows the extracted charge as a function of applied reverse bias for P3HT:PCBM solar cells with various active layer thicknesses and with and without thermal annealing. To extract all charges (extracted charge reaches a plateau), a bias potential of 2 to 3 V was required for thinner (94 nm and 150 nm) annealed active layer P3HT:PCBM solar cells, while 5 V was needed for thicker active layer (207 nm) devices. In the case of as-prepared cells, voltage reaching a plateau was not as obvious as for the case of annealed cells, and 5 to 10 V bias potential was needed to collect most of photo-charges, independent of the active layer thickness of the devices. For annealed thin active layer solar cells, the fraction of charge lost during charge extraction without an applied external bias (short circuit condition) was less than 10%. In the case of solar cells using the thickest active layer, 40% of photogenerated charges were lost. For as-prepared samples, 20 to 45 % of charges were not collected, depending on the film thickness.

Figure 7 shows extracted charge density versus open circuit voltage obtained by charge extraction and open circuit voltage measurements without delay time. The open circuit voltage

was measured under the same light irradiation immediately prior to turning on the switch. With the application of a reverse bias in the case of P3HT:PCBM solar cells using thick active layers, the charge density versus V_{oc} plots appear to shift downward by a maximum of 20 mV (annealed, 4 V applied) to 40 mV (non-annealed, 8 V applied). For 94 nm annealed solar cells, the changes with applied bias were negligible. For as prepared solar cells, on the other hand, a slight downward shift was observed even for the 94 nm active layer devices. The apparent downward shift is due to the increased extracted charge density with applied bias as evident from Figure 6. The slope of the charge density versus V_{oc} plots did not change with applied bias.

Figure 8 shows the effect of bias potential on the integrated charge density as a function of delay times for both the annealed and as-prepared P3HT:PCBM solar cells. Figure 9 shows the charge recombination lifetime (τ) obtained from Figure 8 using equation 2. Figure S3 shows the same data as in Figure 7, 8, and 9, but for a wider range of the bottom axis. These figures reveal two different slopes of n versus t and τ versus n . The measured lifetimes were not significantly affected by an applied bias for P3HT:PCBM solar cells using thinner (94 and 150 nm) annealed active layers. However, the lifetime increased by a factor of two when thick (207 nm) active layers were used. Importantly, with applied bias, the measured lifetime for thick active layer devices matched the values measured for thin films at the same high charge density (1.1×10^{-5} s at 7×10^{16} cm $^{-3}$). At lower charge densities ($< 7 \times 10^{16}$ cm $^{-3}$) the lifetime versus charge density plots showed an apparent thickness dependence, with 94 nm active layer devices showing longer lifetime. For as prepared P3HT:PCBM solar cells, with reverse bias, the lifetime was increased by up to a factor of three (Figure 9(b)) for thicker active layer devices showing larger changes. At higher charge densities ($> 1.5 \times 10^{16}$ cm $^{-3}$), as-prepared P3HT:PCBM solar cells showed shorter recombination lifetime than annealed solar cells. When charge density was

less than $1.5 \times 10^{16} \text{ cm}^{-3}$, annealed and as prepared solar cells showed comparable lifetime values (Figure S3 S.I.).

One concern of a CE measurement using a switch is possible current leakage in the off condition through resistance R_1 . At long delay times when the recombination (parallel) resistance of the solar cell becomes comparable to or lower than the R_1 resistance of the switch ($2.2 \text{ M}\Omega$), the charge density will decay due to recombination and charge leakage, hence charge extraction measurements will no longer be accurate. To check the effect of leakage current through the switch, we measured the open circuit voltage decay of annealed P3HT:PCBM solar cells (94 nm) with various series resistances (Figure S4). As the resistance decreased, faster decays were recorded at times longer than 0.5 ms. This suggests that current leakage to the external circuit was not negligible for long delay times at these lower $< 10 \text{ M}\Omega$ resistances. No change in the decay was observed when larger than $10 \text{ M}\Omega$ was used. We therefore replaced the $2.2 \text{ M}\Omega$ R_1 resistance in the switch box to $10 \text{ M}\Omega$ and measured mCE for the annealed P3HT:PCBM solar cells with 94 nm active layer thickness (Figure S5, S.I.). The extracted charge did not change depending on R_2 up to a 1 ms delay time, which corresponded to the charge density of 10^{16} cm^{-3} . Beyond 1 ms, however, the measurements using the $10 \text{ M}\Omega$ resistor yielded higher charge densities.

The bimolecular recombination coefficient (k) obtained using equation 1 showed a gradual increase with increasing charge density (Figure 10). Furthermore, as-prepared P3HT:PCBM solar cells showed approximately an order of magnitude higher k values at the matched charge density. The slope of the bimolecular recombination coefficient versus charge density was similar for most devices, except for thinner (94 nm and 150 nm) annealed P3HT:PCBM devices showing a smaller slope.

3. Discussion

If charge extraction time t_{extr} is comparable to or slower than the recombination lifetime τ , charge recombination during extraction limit the extracted charge. Applying external bias may speed up charge extraction up to the RC limit t_{RC} , increasing the amount of extracted charge. At high light intensities when the photo-generated charge density in the devices exceed the capacitive charge, the rate of charge extraction may also be limited not by charge carrier transport but the driving force for charge extraction due to the screening of the electric field. As the external bias is increased, the capacitive charge stored on the electrodes is increased, the electric field in the devices at the same level of photo-generated charge concentration increases and the amount of extracted charge per unit time is increased. To understand which of the above mechanisms are responsible for the increased extracted charge using the mCE measurement, the shape of the current transients are analyzed and discussed below.

3.1 Faster charge extraction due to applied bias ($t_{extr} < \tau$)

A larger applied bias could lead to faster charge extraction due to larger electric field. This explanation seems consistent with the observed trends in Figure 6 showing that a larger applied bias was needed for the thicker active layer devices (slower extraction due to larger distance as well as lower electric field at the same applied voltage) and for the devices with faster inherent recombination (as prepared solar cells). Figures 3 and 4 indeed show slightly faster transient current decays by applying a reverse bias, but only for the annealed cell. The transient current decays for the annealed cell in Figure 3 were fitted with an exponential function, yielding time constants of 740 ns to 257 ns as the bias was increased from 0 to 8 V. The time constant of the

dark current response was 195 ns, which is close to the estimated 230 ns RC time constant. Thus, the smaller time constant with higher bias potential can be interpreted with faster charge transport, limited by the RC time constant at the highest applied bias ($\tau_{RC} \approx t_{extr}$). On the other hand, for as-prepared P3HT:PCBM solar cells, the time constant of the transient currents in Figure 3(b) decreased only marginally from 350 ns to 308 ns as the bias increased from 0 to 8 V. With 8 V bias potential, the time constant of the dark current transient was 192 ns. The smaller time constant values measured for as-prepared cells could be due to faster charge transport in the non-annealed solar cells compared to the annealed cells. This explanation is, however, inconsistent with photo-CELIV measurements, showing two times faster mobility for annealed solar cells compared to as prepared ones (Figure S6, S.I.). Another explanation for the observed faster current transients of the as-prepared solar cells is that the transient decay is limited by fast charge recombination, and not charge extraction, i.e. ($\tau < t_{extr}$). The longer current transients expected due to lower mobility were not observed, probably because significant charge recombination occurred during charge extraction limiting the transient decays. This explanation is consistent with the measured shorter lifetimes and larger bimolecular recombination coefficients for as prepared cells in Figure 9 and 10. If the charge recombination lifetime is close to or faster than the RC time constant ($\tau \approx \tau_{RC}$), the transients are RC influenced. As the voltage bias was increased, charge extraction was facilitated and became also comparable to RC ($\tau_{RC} \approx t_{extr} \approx \tau$). The observed time constant for current transient did not change, but the underlying process is shifted from recombination influenced to charge extraction influenced, both close to the RC limit. There is, however, an inconsistency with the above explanation in Figure 5. While faster current transient is obtained using smaller R_2 resistance due to faster RC time constant, the integrated charge did not increase ($\tau_{RC} < t_{extr} \approx \tau$).

This leads us to conclude that faster charge transport competing with recombination is not the main reason for the increased extracted charge for the devices with thin active layers.

3.2 Space charge limited extraction current transients

Figure 3 and 4 clearly show that the main effect of applied bias on the current transient for both annealed and as-prepared P3HT:PCBM solar cells is the increased *magnitude* of the extracted current with applied bias, and not the faster extraction time. The integrated photogenerated charge was comparable or exceeded the amount of capacitive charge at the higher laser intensities (20 mW and 100 mW), suggesting the screening of the applied electric field by the photogenerated charge stored in the devices during charge extraction. The current rise at high laser intensities is consistent with space charge disturbed current transients to an applied voltage step.^[17] Charge mobility calculated using equation 3 from the characteristic time to reach the current peak yielded mobility values of $10^{-4} \text{ cm}^2 \text{ V}^{-1}\text{s}^{-1}$, which is comparable to the values obtained by photo-CELIV ($0.5 \times 10^{-4} \text{ cm}^2 \text{ V}^{-1}\text{s}^{-1}$, Figure S6, S.I.) and from literature reports for similar devices.^[14, 18] Such space charge disturbed extraction is expected at high laser intensities (large photogenerated charge density), thicker active layers (lower capacitance hence smaller capacitive charge), low voltages and longer lifetime (increased charge density surviving recombination during the delay time). In case of space charge limited extraction, only a fraction of the charge (CV_{appl}) is extracted at any given time. The remaining charges remain in an electric field-free region of the device. If the lifetime within this reservoir of charges is longer than the extraction time, charge density larger than CV_{appl} can be extracted.^[19] Otherwise, the charges in the “reservoir” recombine and do not contribute to the extraction transient. The interesting feature of the mCE transients is the appearance of a rise time in the current transient, which is

typically observed in case of surface charge generation. Given that the charge generation profile can be assumed to be uniform (optical density at laser excitation wavelength comparable to active layer thickness), these results imply the redistribution of the charges to near the contacts before charge extraction began, i.e. switch is turned on.

To summarize the effect of external bias for the case of space charge disturbed transient, as the electric field is increased, the rate of charge extraction dQ/dt is increased leading to less recombination of the remaining charges in the reservoir. Due to the longer charge carrier lifetime caused by decreased carrier density due to increased extraction rate, the amount of extracted charge is increased with applied bias.

3.3 Increased lifetime due to spatial separation of charges (even at low light intensity)

A slight increase in extracted charge density with applied bias was observed even at low light intensities, when the transients did not show any signs of space charge limitation, and the extracted charge was much less than the capacitive charge, for example, the case using 5 mW laser power in Figure 4. We interpret the increased extracted charge in this case to arise from prolonged recombination lifetime under the externally applied electric field during charge extraction, caused by the increased spatial separation of the electrons and holes in the solar cells by the applied electric field. Recent publications suggest higher hole concentrations near the ITO and higher electron concentration near the metal contact at open circuit condition.^[7, 8] When reverse bias is applied, more holes (electrons) will be attracted at the ITO (metal contact), decreasing recombination probability. The higher concentration of electrons and holes near contacts results in higher initial current. The requirement of higher applied potential for thicker film is consistent with the electric field dependence on film thickness, that is, when the

thickness is doubled, the potential difference needs to be doubled to obtain the same electric field.

Further support for the above explanation is found in Figure 9 showing an apparent thickness dependent lifetime at lower charge density, converging to a thickness independent lifetime at higher charge densities. This observation can be interpreted by the spatial distribution of charges in the active layer.^[13, 14] The re-distribution of electron and hole densities caused by the electric field at the ITO and metal electrodes due to the work function difference (no external applied field) resulted in higher hole concentration at ITO side and higher electron concentration at metal electrode side. The distribution became more homogeneous for thicker active layers due to the weaker electric field, resulting in lower extent of spatial charge separation. The apparent longer recombination lifetime in thin solar cells is therefore attributed to a larger extent of spatial charge separation caused by stronger internal electric field. The convergence of the apparent lifetime at high charge densities among the different thickness solar cells is due to a more uniform charge distribution, regardless of the thickness, with the increase of charge density. Less prominent thickness dependence at high charge density was also observed in the V_{oc} versus charge density in Figure 7, consistent with the explanation based on a charge density dependent charge distribution in the film.

Note that the convergence of the V_{oc} and lifetime in Figure 7 and 9 is more prominent for annealed solar cells. It has been reported that the ratio of P3HT to PCBM is homogeneous through the thickness of the film when the cells were prepared with 40% PCBM and annealing process.^[20] The prominent convergence for the annealed cells in Figure 7 and 9 seems to suggest the homogeneous distribution of PCBM and P3HT regardless of the thickness.

3.4 The effect of switch-off resistance on charge extraction and charge recombination lifetime measurements

Smaller slopes in Figure S3 (plots of charge density versus t and τ versus charge density) at the lower charge density region were observed. This could be due to charge leakage through the switch to the external circuit, causing charge density decay in addition to charge recombination in the switch off state.^[21] The 2.2 M Ω switch-off resistance R_2 in combination with a 1.5 nF solar cell capacitance yields an RC time constant on the order of 10^{-3} s, which is shorter than the measured lifetime of 2 to 10 ms obtained at the lower charge densities. Higher charge densities and longer charge carrier lifetimes were obtained when the R_2 resistance was increased to 10 M Ω (Figure S5(a) and (b) in S.I.), confirming that the effect of charge leakage through the switch caused the apparent shortening of the charge carrier lifetime. The dependency of recombination lifetime on charge density (the recombination order) does not appear to be affected. The effect of charge leakage through the switch on V_{oc} versus charge density plot is less clear from Figure S5(c). In principle, charge leakage should not change the plot as long as the resistance used in the photovoltage measurements and the charge extraction measurements is the same.

4. Conclusions

We introduced a modified the charge extraction technique mCE by designing a new switch with the added capability of applying an external bias to facilitate charge extraction in BHJ solar cells. This new capability allowed us to quantify charge extraction losses in solar cells with thick active layers, slow mobility or fast recombination, by performing mCE measurements on P3HT:PCBM solar cells with as-prepared and annealed active layers. Up to 40% increase in the

amount of extracted charge was obtained with externally applied bias. Up to 8 V applied bias was needed to reach saturation of the extracted charge when active layers with fast recombination or larger thicknesses were used. The increase in extracted charge was explained based on three cases of enhancement of charge extraction with applied bias: i) faster charge extraction time due to higher electric field; ii) enhanced charge extraction rate due to larger external electric field in case of space charge disturbed extraction transients; iii) increased charge carrier lifetime during charge extraction due to the spatial separation of electron and hole distribution in the devices due to applied electric field. The latter effect also explained the apparent thickness and charge density dependence of the measured charge carrier lifetimes for solar cells with three different active layer thicknesses. The extracted charges at various thicknesses converged to similar values at high applied biases, consistent with lesser extent of spatial separation in thicker active layer devices. At high charge densities, the distribution was more uniform due to better screening electric field. The results also suggest that the recombination lifetime and V_{oc} versus charge density relationship can be more reliably obtained from thicker solar cells, provided there were no recombination losses during extraction. Compared to conventional charge extraction techniques, the modified CE technique reported here provides a significant improvement to measure charge density and lifetime for BHJ solar cells with thick active layers, low charge mobility or fast recombination.

5. Experimental Section

Solar cells were fabricated as described in Supporting Information. Charge extraction was performed using the setup shown in Figure 1. A solar cell was connected to a fast FET switch (SR-05, Asama Lab), a function generator (WF1973, NF Corporation, Japan), and an

oscilloscope (TDS3012C, Tektronix) in series. The measurement used a diode laser ($\lambda = 641$ nm, CUBE, Coherent) as the illumination source. The timing to i) control the laser intensity, ii) to turn on the switch and iii) to apply a reverse bias was controlled by a delay generator (DG645, Stanford Research Systems). No bias was applied while the switch was in the high impedance off state. The rise time of current transient was about 100 ns when the voltage bias was applied through the switch while it was simultaneously turned on, which is the time resolution of the mCE setup. The laser beam from the CUBE laser was expanded by a lens to achieve a 5 mm diameter beam on the sample. The internal resistance of the oscilloscope was 1 M Ω . The purpose of R_1 in the switch box is to protect the FET switch and the purpose of R_2 is to measure the current by the oscilloscope. The R_2 was set as 50 Ω , except for the measurements shown in Figure 3. The solar cells were irradiated by the laser for 30 ms at open circuit conditions, which was sufficiently long to obtain a steady state condition. Then the laser was turned off, and the time to turn on the switch, referred to as delay time, was varied. The charge extraction transients were measured 32 times under each experimental condition and were averaged. The amount of extracted charge was obtained by integrating the averaged current transient. The open circuit voltage of the solar cells was measured under the same laser irradiation using the 1 M Ω internal resistance setting of the oscilloscope. The V_{oc} values measured by the oscilloscope were a few millivolts lower than the values measured by a high impedance multimeter (> 10 M Ω) under the same high light intensity. The deviation between the two V_{oc} values was larger at a lower light intensity (corresponding to less than 450 mV open circuit voltage) of the P3HT:PCBM annealed solar cells. The amount of photogenerated charge and the magnitude of the V_{oc} were varied by changing the laser intensity. The V_{oc} versus charge density (n) plot was obtained by repeating the V_{oc} and charge extraction measurements at different laser intensities. The charge

density versus delay time (t) plot was obtained by repeating the charge extraction measurement with different delay times at the same laser intensity. The bimolecular recombination coefficient, k , was obtained from equation 1,

$$\frac{\Delta n}{\Delta t} = -kn^2 \quad (1)$$

and charge recombination lifetime (τ) was obtained from the equation 2,

$$\tau = \frac{1}{kn} \quad (2)$$

, where Δn and Δt were obtained from the two adjacent points in the charge density versus time plots.

Charge mobility was estimated as

$$\mu = 0.786 \times \frac{d^2}{t_{max} \times V_{app}} \quad (3)$$

, where d is the film thickness, t_{max} is the time to reach the current maximum and V_{app} is the applied voltage.^[16]

The capacitive charge was calculated as CV_{app} , where C is the geometric capacitance measured by integrating the current transient without laser illumination. The obtained values closely matched the geometric capacitance values calculated based on the dielectric constant of the polymer:PCBM blends, the active area and the film thickness.

Supporting Information

Supporting Information is available from the Wiley Online Library

Received: ((will be filled in by the editorial staff))

Revised: ((will be filled in by the editorial staff))

Published online: ((will be filled in by the editorial staff))

- [1] S. K. Pal, T. Kesti, M. Maiti, F. Zhang, O. Inganäs, S. Hellström, M. R. Andersson, F. Oswald, F. Langa, T. Österman, T. Pascher, A. Yartsev, V. Sundström, *J. Am. Chem. Soc.* **2010**, *132*, 12440.
- [2] A. Maurano, C. G. Shuttle, R. Hamilton, A. M. Ballantyne, J. Nelson, W. Zhang, M. Heeney, J. R. Durrant, *J. Phys. Chem. C.* **2011**, *115*, 5947.
- [3] J. A. Bartelt, D. Lam, T. M. Burke, S. M. Sweetnam, M. D. McGehee, *Adv. Energy Mater.* **2015**, *5*, 1500577.
- [4] M. C. Scharber, D. Wuhlbacher, M. Koppe, P. Denk, C. Waldauf, A. J. Heeger, C. L. Brabec, *Adv. Mater.* **2006**, *18*, 789.
- [5] A. Maurano, R. Hamilton, C. G. Shuttle, A. M. Ballantyne, J. Nelson, B. O'Regan, W. Zhang, I. McCulloch, H. Azimi, M. Morana, C. J. Brabec, J. R. Durrant, *Adv. Mater.* **2010**, *22*, 4987.
- [6] N. W. Duffy, L. M. Peter, R. M. G. Rajapakse, K. G. U. Wijayantha, *Electrochem. Commun.* **2000**, *2*, 658.
- [7] C. G. Shuttle, A. Maurano, R. Hamilton, B. O'Regan, J. C. de Mello, J. R. Durrant, *Appl. Phys. Lett.* **2008**, *93*, 183501.

- [8] T. M. Clarke, C. Lungenschmied, J. Peet, N. Drolet, A. J. Mozer, *Adv. Energy Mater.* **2015**, *5*, 1401345.
- [9] J. Mort, I. Chen, A. Troup, M. Morgan, J. Knights, and R. Lujan, *Phys. Rev. Lett.* **1980**, *45*, 1348.
- [10] A. J. Mozer, N. S. Sariciftci, A. Pivrikas, R. Österbacka, G. Juška, L. Brassat, H. Bässler, *Phys. Rev. B* **2005**, *71*, 035214.
- [11] I. Lange, J. Kniepert, P. Pingel, I. Dumsch, S. Allard, S. Janietz, U. Scherf, D. Neher, *J. Phys. Chem. Lett.* **2013**, *4*, 3865.
- [12] J. Kniepert, I. Lange, N. J. van der Kaap, L. J. A. Koster, D. Neher, *Adv. Energy Mater.* **2014**, *4*, 1301401.
- [13] C. Deibel, A. Wagenpfahl, *Phys. Rev. B* **2009**, *80*, 075203.
- [14] F. Deledalle, P. S. Tuladhar, J. Nelson, J. R. Durrant, T. Kircharz, *J. Phys. Chem. C* **2014**, *118*, 8837.
- [15] A. Baumann, J. Lorrmann, D. Rauh, C. Deibel, V. Dyakonov, *Adv. Mater.* **2012**, *24*, 4381.
- [16] M. A. Lampert, P. Mark, *Current Injection in Solids*, Academic Press, NY, USA **1970**.
- [17] A. Pivrikas, N. S. Sariciftci, G. Juška, R. Österbacka, *Prog. Photovolt: Res. Appl.* **2007**, *15*, 677.
- [18] V. D. Mihailetschi, H. X. Xie, B. de Bore, L. J. A. Koster, P. W. M. Blom, *Adv. Funct. Mater.* **2006**, *16*, 699.
- [19] A. Pivrikas, G. Juška, A. J. Mozer, M. Scharber, K. Arlauskas, N. S. Sariciftci, *Phys. Rev. Lett.* **2005**, *94*, 176806.
- [20] S. S. van Bavel, M. Barenklau, G. de With, H. Hoppe, J. Loos, *Adv. Funct. Mater.* **2010**, *20*, 1458.

[21] L. C. C. Elliott, J. I. Basham, K. P. Pernstich, P. R. Shrestha, L. J. Richter, D. M. DeLongchamp, D. J. Gundlach, *Adv. Energy, Mater.* **2014**, *4*, 1400356.

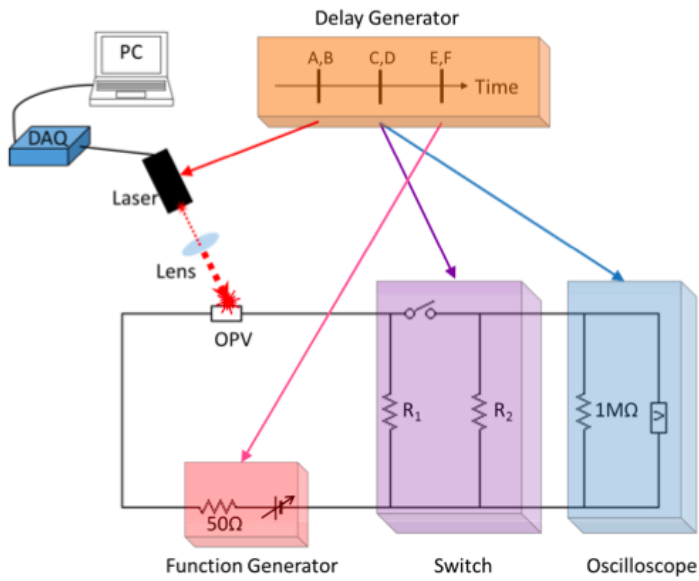

Figure 1. Experimental setup for modified charge extraction.

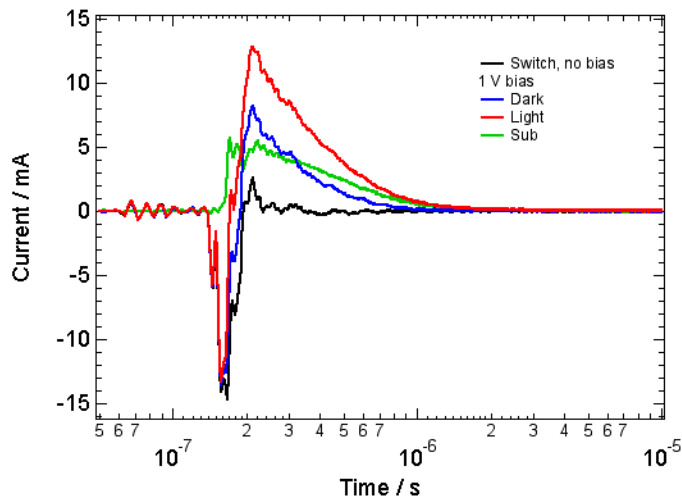

Figure 2. Typical transient current for BHJ solar cells. A reverse bias of 1 V was applied during charge extraction.

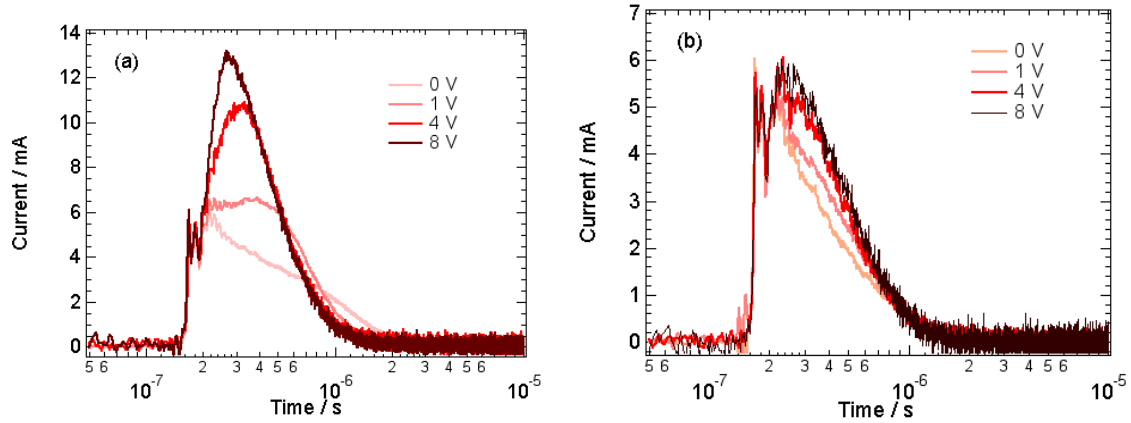

Figure 3. Transient currents from annealed (a) and as-prepared (b) solar cells with different reverse bias potentials. Thickness of solar cell is 94 nm.

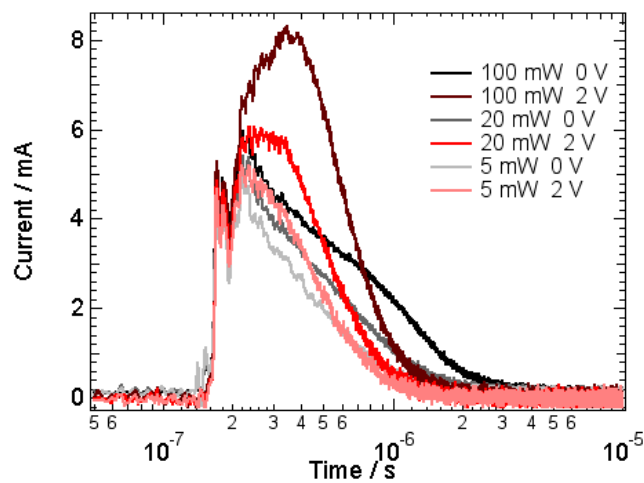

Figure 4. Transient currents from annealed solar cells irradiated by different laser powers. Thickness of solar cell is 94 nm. The current was obtained with and without reverse bias.

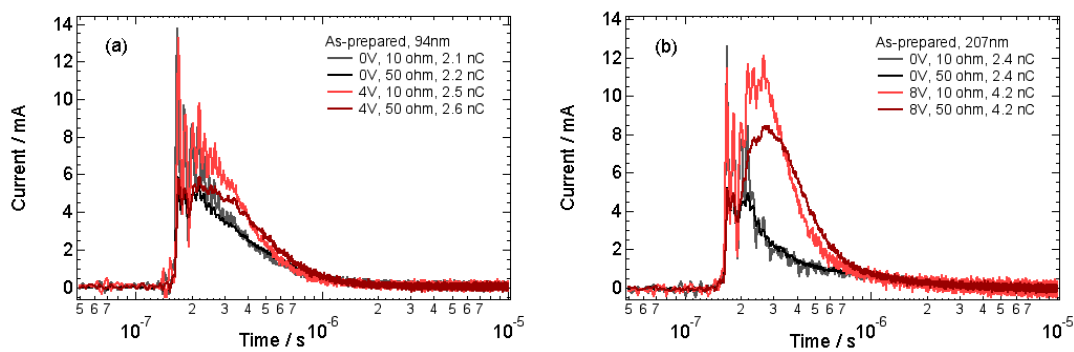

Figure 5. Transient currents from as-prepared solar cells with 94 nm (a) and 207 nm (b) active layer thickness measured with two different resistors connected with the solar cell in series. Applied voltage and integrated charges are shown in the Figure. Laser power was 100 mW.

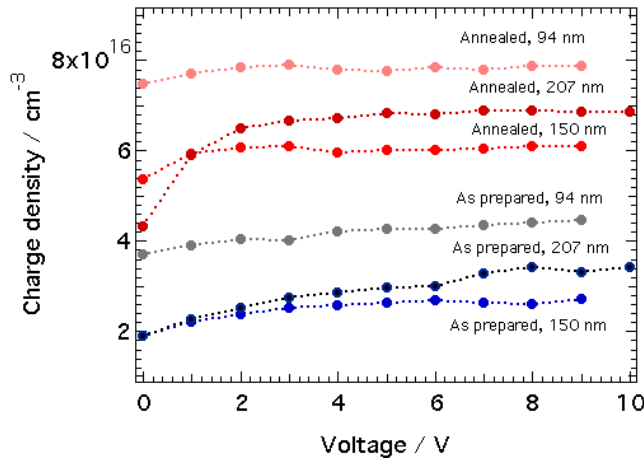

Figure 6. The extracted charge density of the solar cells under different reverse bias potentials.

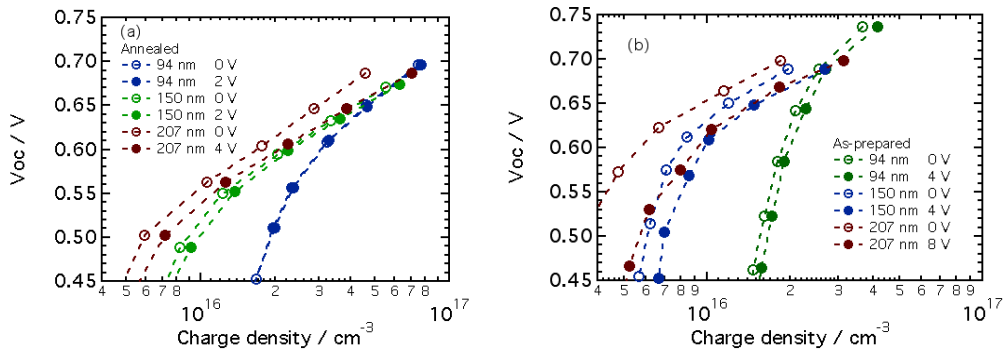

Figure 7. Open circuit voltage as a function of extracted charge density in the solar cells. Data was obtained from solar cells prepared with (a) and without (b) annealing process.

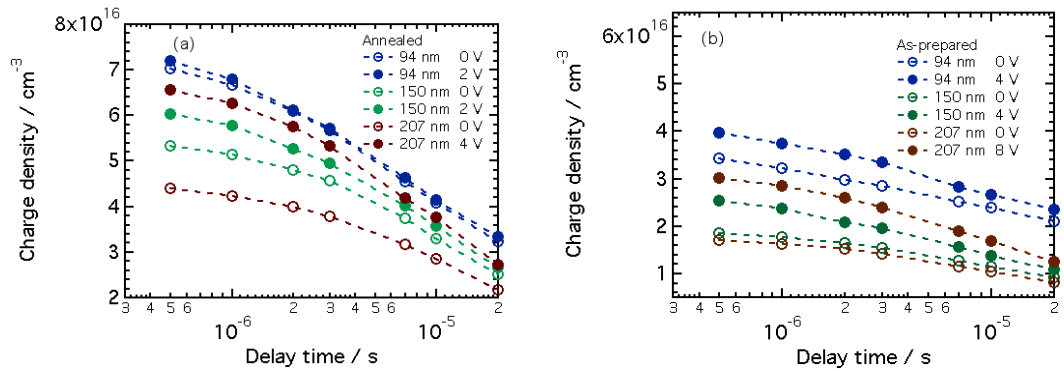

Figure 8. Extracted charge density as a function of delay time. Data was obtained from solar cells prepared with (a) and without (b) annealing process.

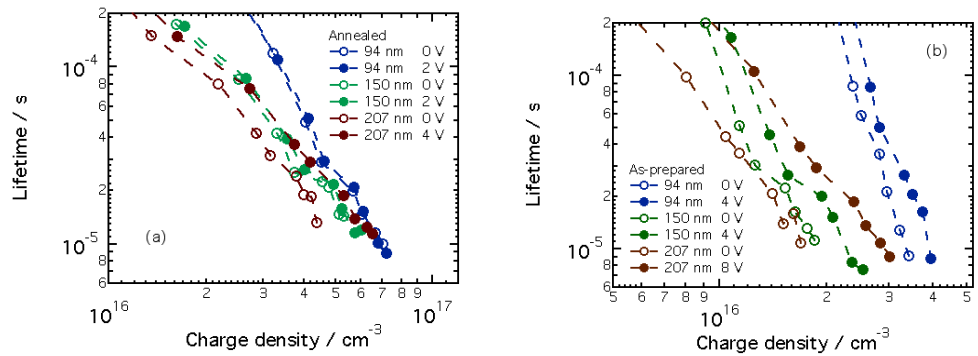

Figure 9. Charge recombination lifetime obtained from the slope in Figure 8. Data was obtained from solar cells prepared with (a) and without (b) annealing process.

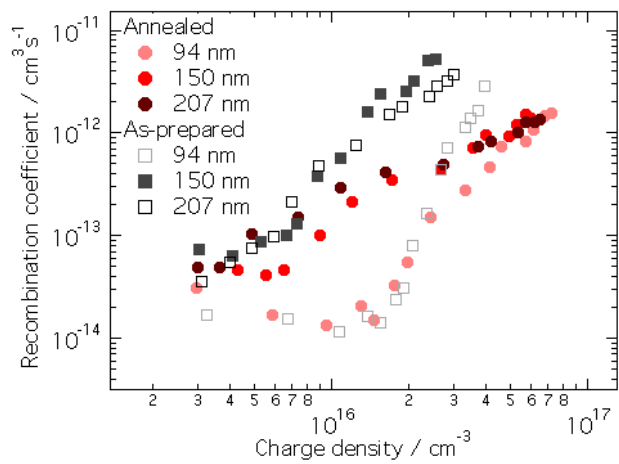
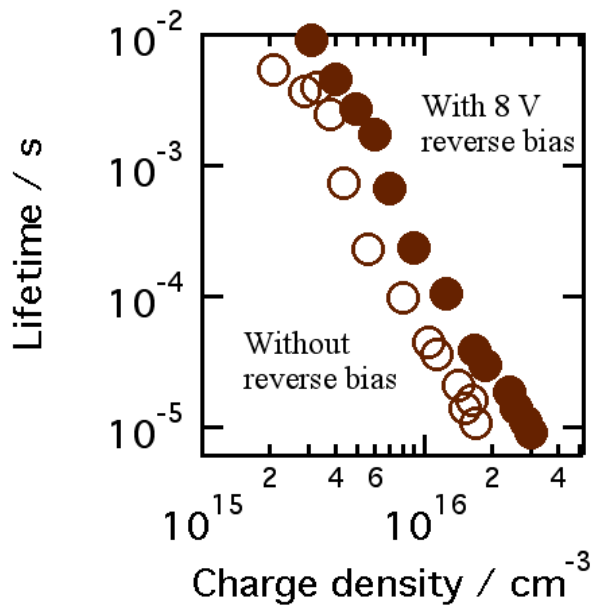

Figure 10. Bimolecular recombination coefficients obtained from Figure 9.

Keyword: recombination coefficient, lifetime, energy levels, charge transport, mobility

Brendan Wright, Yukihiro Nakajima, Tracey M. Clarke, Kouichi Okuda, Heikki Paananen, Attila J. Mozer*, Shogo Mori*

Title: Quantifying Recombination Losses during Charge Extraction in Bulk Heterojunction Solar Cells using a Modified Charge Extraction Technique



Reverse bias during charge extraction is applied through a fast switch to BHJ solar cells.

More than 40 % increase in the extracted charge is seen and the recombination lifetime obtained from the relation between the extracted charge and switching delay time is increased up to three times, showing the importance of reverse bias to measure lifetime.