

SUPPLEMENTARY MATERIAL

Cross-talk between *invariant* natural killer T cells and monocytes triggers an atheroprotective immune response in SLE patients with asymptomatic plaque

Supplementary Materials and Methods

Fig. S1: Analysis of iNKT cell phenotype in SLE patients and HCs

Fig. S2. *i*NKT cells from SLE-P patients had an activated phenotype compared to SLE-NP patients and healthy donors

Fig. S3. Serum cytokine and metabolite expression levels in SLE patients with and without plaque

Fig. S4: Hierarchical clustering of metabolites with most significant differences between SLE-NP and SLE-P patients

Fig. S5: Monocyte/macrophage phenotype in SLE-P, SLE-NP patients and healthy donors

Fig. S6: *i*NKT cell frequency and IL4 production correlates with plaque stability measured by Grey Scale Median (GSM)

Fig S7: Comparison of serum lipid profiles in SLE-P and SLE-CV patients.

Table S1: SLE patient and Healthy donor characteristics

Table S2: Plasma cytokine levels measured by proteomic analysis in in SLE patients with pre-clinical plaque compared to those without plaque.

Table S3: Serum metabolites significantly altered in SLE patients with pre-clinical plaque compared to those without plaque

Table S4: SLE patient serum lipids and biomarkers

Table S5: Correlation of serum metabolites with *i*NKT cell frequency and IL-4 production in SLE-P and SLE-NP patients

Table S6: SLE cardiovascular event (SLE-CV) patient clinical characteristics

SUPPLEMENTARY METHODS

Vascular ultrasound scans of patients

Ultrasound scans and blood donation were carried out subject to informed written consent which was obtained from all participants under the guidelines of University College Hospital London. Vascular ultrasound scans of the common carotid artery, carotid bulb, carotid bifurcation, common femoral artery and femoral bifurcation were performed bilaterally using the Philips IU22 ultrasound computer and the L9-3 MHz probe. IMT measurements were performed using QLAB Advanced Quantification Software® version 7.1 (Philips Ultrasound, Bothell, USA).

Plaque was defined as “*a focal thickening >1.2 mm that encroaches into the arterial lumen as measured from the media-adventitia interface to the lumen interface*” (1). Patients who had at least one region fulfilling this description were included in the group with plaque (SLE-P). Of the 100 patients, 36 had plaque in at least one of the four arteries (two carotid and two femoral) scanned. There were 84 plaques in total and 15 patients had plaque in at least three sites (5 in all four sites). Plaque was confined to the femoral arteries in 7 patients. Table S1 shows clinical, demographic, serological, therapy and disease activity characteristics of patients in the plaque and no plaque groups.

At the end of this assessment, while supine, BP was measured in the left upper arm using an automated BP reader (Omron M6 HEM-700-E). Three measurements were taken and the first discarded. Peripheral blood samples (serum and PBMC) were also collected at the time of the scan and at subsequent clinic visits. SLE disease activity was determined by the British Isles Lupus Assessment Group (BILAG) Index . Patients with persistently active disease were identified as having a Global BILAG score >5 in at least two consecutive visits from the previous four visits.

Grey Scale Median: Plaque echogenicity was characterized by automated software (Plaque texture analysis software – image analysis program for ultrasonic arterial wall changes and atherosclerotic plaques - version 4.5 (LifeQ Ltd: www.lifeqmedical.com). Plaque echogenicity measured by the latter method was made after image normalisation using linear scaling with blood (Gray scale=0) and adventitia (Gray scale=190) as 2 reference points. It was expressed numerically by the Grey Scale Median (GSM) value (2). The median GSM value for plaque in the 36 plaque-positive patients was 48.9 (IQR 34.3-59.0) with a range of 1-128. Lower GSM values signify more echolucent plaque(3).

Cytometric bead array (CBA)

Cell culture supernatants were assessed for cytokines using CBA Flex kits (BD Bioscience) for IL2, IL4, IL6, IL10, IL12, IL13, IL17a, IFN- α , IFN- γ and TNF- α according to manufacturer's instructions before acquisition and analysis using BD FACS Array.

Proteomic analysis of plasma

Plasma was analysed by SOMAscan™ (Slow Off-rate Modified Aptamer) Proteomic Assay (Somologic, INC) by UCL Institute of Cardiovascular Science(4). Analysis of the data was carried out by Dr. Engmann (UCL Institute of Cardiovascular Science).

SUPPLEMENTARY FIGURES

Figure S1

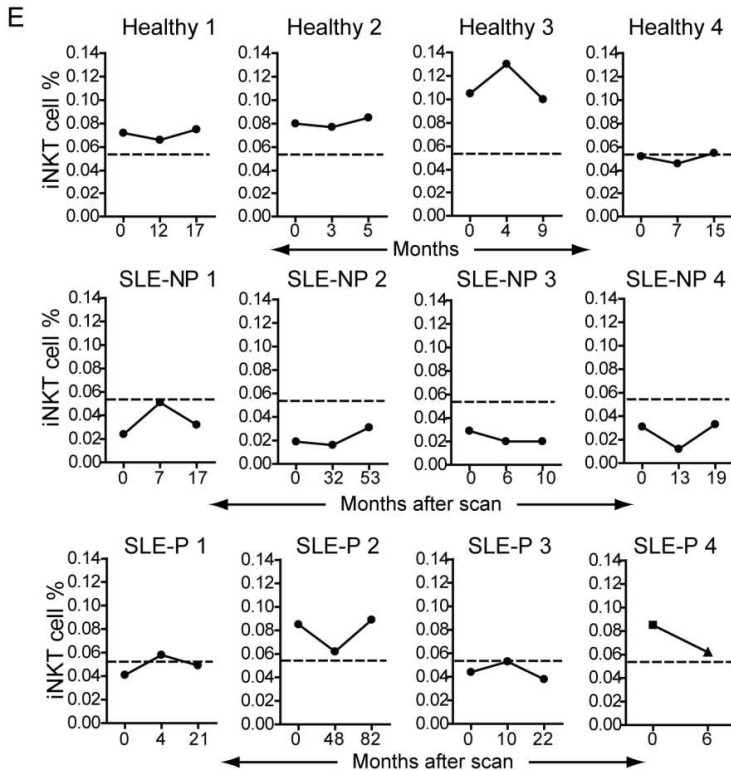
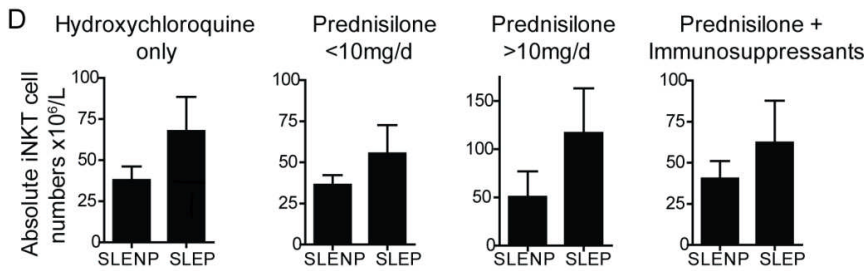
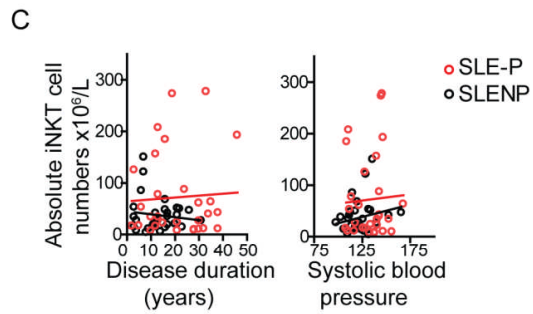
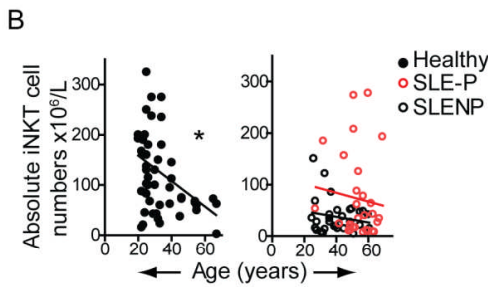
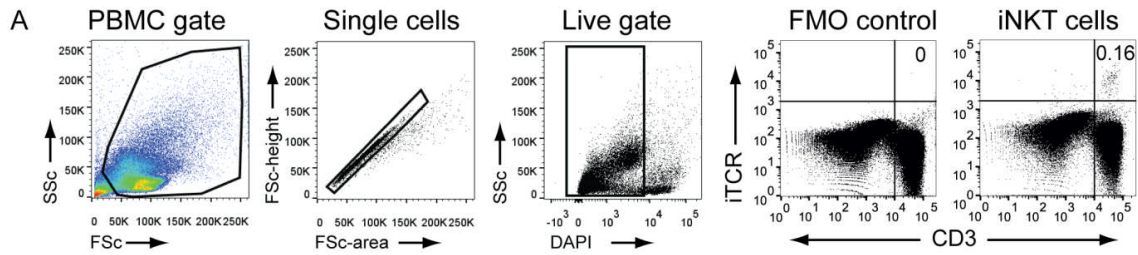

Fig. S1: Analysis of iNKT cell phenotype in SLE patients and HCs

Fig. S1A: Gating strategy for the detection of iNKT cells in peripheral blood

Gating strategy used for detection of iNKT cells by flow cytometry. Cells within the PBMC gate were assessed for single cells (to exclude conjugated/clumped cells) and cell viability using a live/dead stain (DAPI, to exclude dead cells) before gating for CD3 and *i*TCR (clone 6B11) to determine iNKT cell frequency. Gates were set using fluorescence minus one (FMO) controls.

Figure S1B-D: Correlation of iNKT cell numbers with cardiovascular risk factors and treatment

PBMC from SLE patients with plaque (SLE-P, n=22-27) and SLE patients without plaque (SLE-NP, n=26-37) and healthy donors (n= 50) were assessed for iNKT cell frequency using antibodies to CD3 and *i*TCR.

(B) iNKT cell frequency in healthy donors, SLE-P and SLE-NP patients were correlated with age. Interestingly, when considering healthy donors there was a significant negative correlation between iNKT cell frequency and age confirming previous observations (5).

However, this correlation was lost in SLE patients supporting our findings that iNKT cell phenotype is dysregulated in SLE. Pearson's correlation; Healthy donors: $p=0.002$, $r=-0.393$, SLE-NP and SLE-P: $p=ns$.

(C) Correlation of iNKT cell numbers with disease duration and systolic and pulse pressure, characteristics that showed significant differences between the patient groups (table S1).

Pearson's correlation $p=ns$ for all comparisons.

(D) iNKT cell frequency in the SLEP and SLENP groups was compared according to patient therapy. The data supports our previous findings that therapy alone does not significantly influence iNKT cell frequency. In this study, table S1 also shows that there was no significant difference in treatment between patient groups. Mean \pm SE.

Figure S1E: iNKT cell frequencies remained stable over time in healthy donors and SLE patient groups

iNKT cell frequency was assessed in PBMCs collected at different time points in healthy donors or SLE patients after the original scan. Graphs showing longitudinal differences in the frequency of iNKT cells in 4 representative healthy donors, SLE patients with plaque (SLE-P) and SLE patients without plaque (SLE-NP). Dotted line indicates the mean iNKT cell frequency of healthy donors.

Figure S2

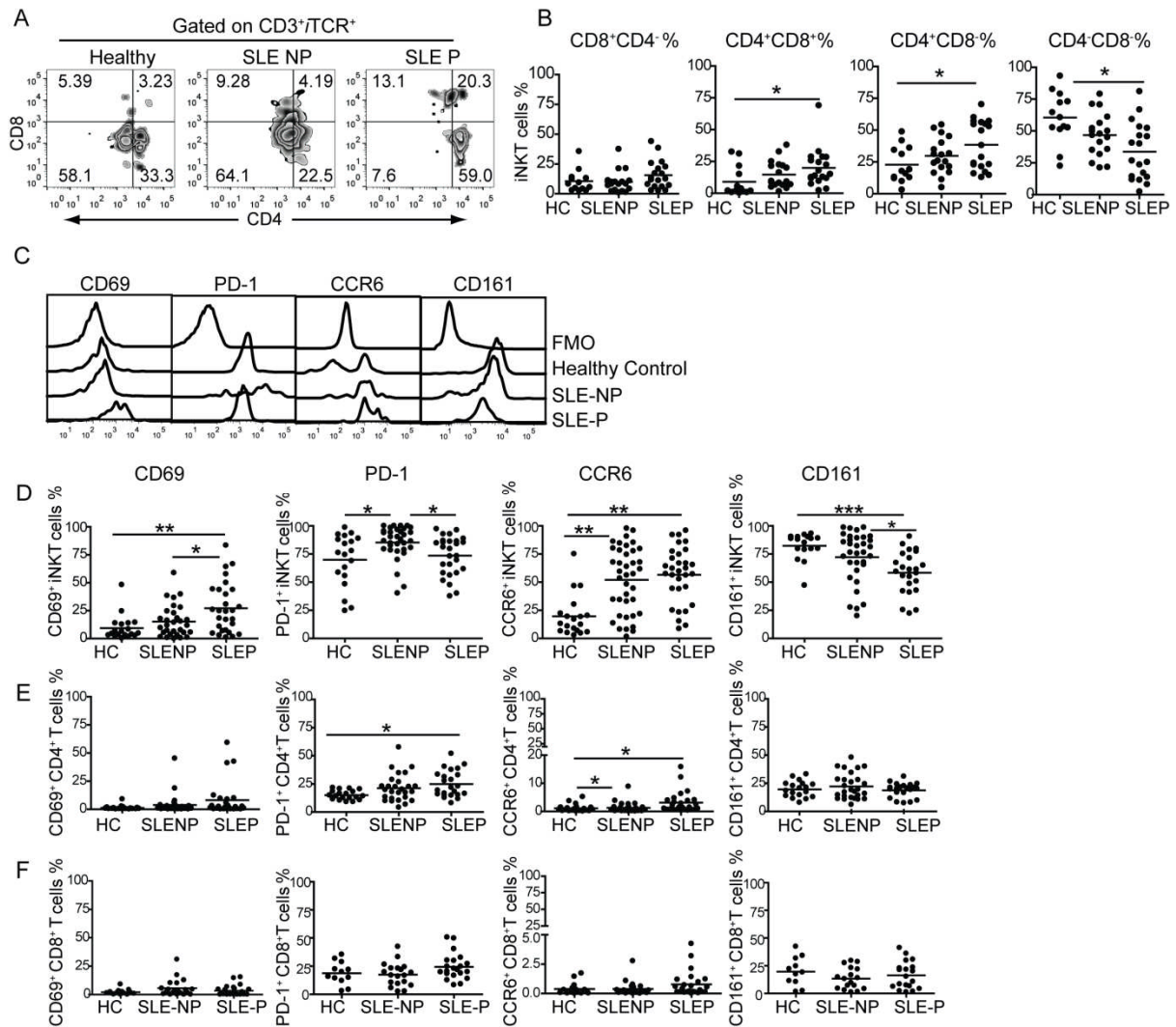

Fig. S2: *i*NKT cells from SLE-P patients had an activated phenotype compared to SLE-NP patients and healthy donors

Analysis of *i*NKT cell phenotype was performed using polychromatic flow cytometry in healthy (n=13), SLE-NP (n=18) and SLE-P (n=19) populations. CD3, *i*TCR, CD4 and CD8 labelling was used to identify *i*NKT cell subsets. (A) Representative dotplots and (B) cumulative data. Shown as mean % expression on *i*NKT cells (HC vs SLE-P in CD4⁺CD8⁺ and CD4⁺CD8⁻, *p=0.05 and CD4⁻CD8⁻, *p=0.01; One-Way Anova and post T-test).

*i*NKT cell phenotype was examined by flow cytometry in healthy (n=19), SLE-NP (n=33) and SLE-P (n=27) using antibodies to CD3, *i*TCR, CD69, PD-1, CCR6 and CD161 (***p=0.0001; **p<0.001, *p<0.05; One-Way Anova and post T-test). (C) Representative histograms and (D) cumulative data showing mean % expression on *i*NKT cells.

Cumulative data showing mean expression of markers examined in (C and D) on (E) CD3⁺CD4⁺*i*TCR⁻ T cells (*p=0.05, One-Way Anova and Tukey's post T-test) and (F) CD3⁺CD8⁺*i*TCR⁻ T cells. FMO= fluorescence minus one control.

Figure S3

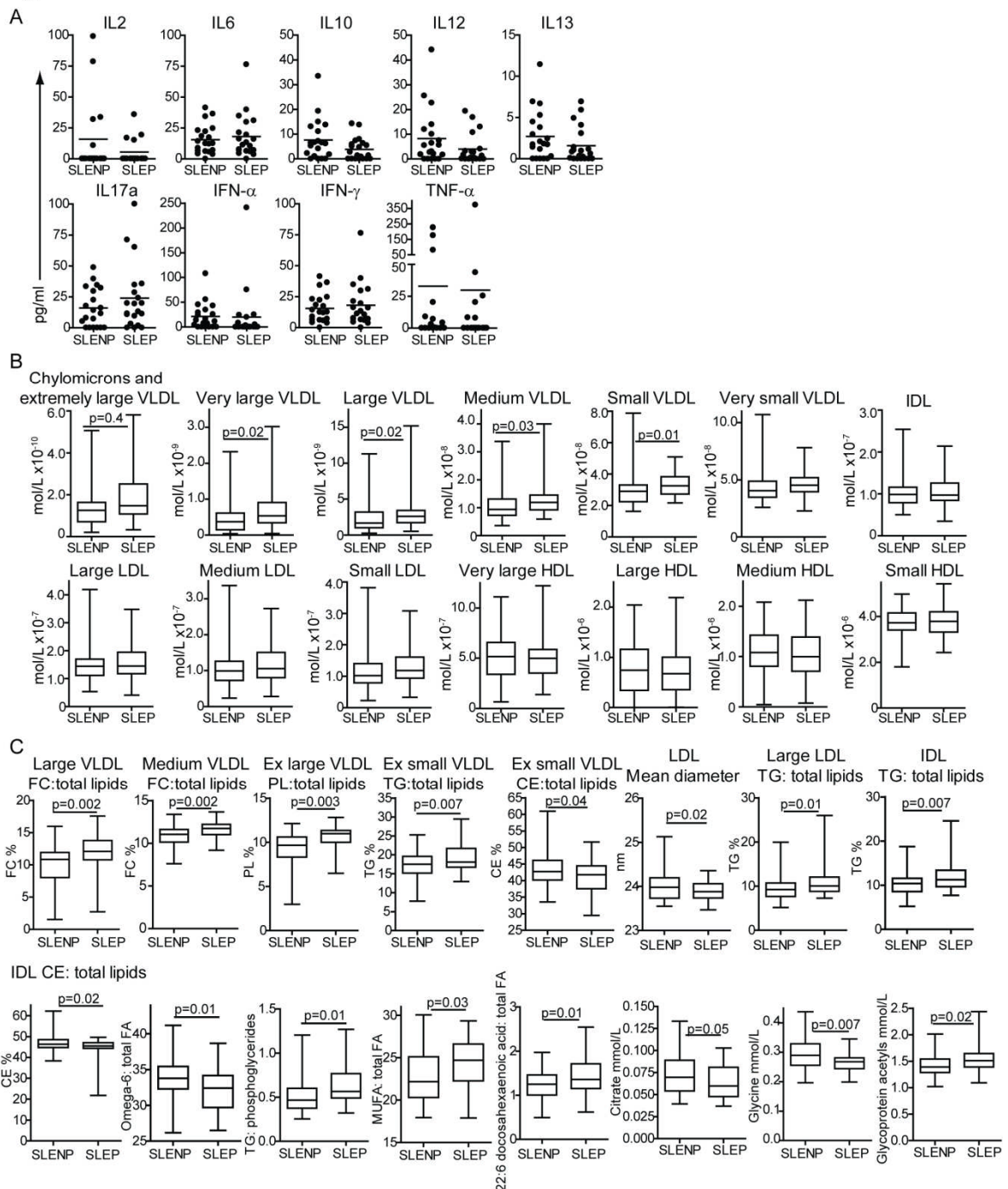

Fig. S3. Serum cytokine and metabolite expression levels in SLE patients with and without plaque

Fig. S3A: Serum cytokine expression levels are similar in SLE patients with and without plaque. (A) Serum from 20 SLE-NP and 20 SLE-P patients taken at the time of the carotid/femoral ultrasound scan were analysed by Cytometric Bead Array (CBA, BD Bioscience) for the following cytokines: IL2, IL4, IL6, IL10, IL12, IL13, IL17a, IFN- α , IFN- γ and TNF- α according to manufacturer's instructions. No signal was detected for the presence of IL4 using this method (data not shown). Scatterplot showing mean. No significant differences in cytokine expression levels were detected between SLE-NP and SLE-P patients using a Mann Whitney test.

Fig. S3B and C: Serum metabolomics analysis in SLE patients with and without plaque.

Serum samples taken at the time of femoral and carotid ultrasound scan from 33 SLE patients with carotid or femoral plaque (SLE-P) and 53 patients with no plaque (SLE-NP) were assessed by proton nuclear magnetic resonance spectroscopy for 230 serum lipid metabolites. Comparison of lipoprotein particle levels (**B**) and proportions of total serum cholesterol, phospholipids and triglycerides carried by each lipoprotein subclass were determined(6) (**C**). Box and whisker plot showing the markers with significant differences between SLE patients with and without plaque using multiple Students T tests, a 95% confidence interval (no significance was seen using the Bonferoni correction).

HDL, high density lipoprotein; LDL, low density lipoprotein; IDL intermediate density lipoprotein; VLDL, very low density lipoprotein; SLE-P, SLE patients with plaque; SLE-NP, SLE patients without plaque. TG, triglycerides; FA, fatty acid; PL, phospholipid; CE, cholesterol esters; FC, free cholesterol; MUFA, monounsaturated FA. Mann Whitney test.

Figure S4

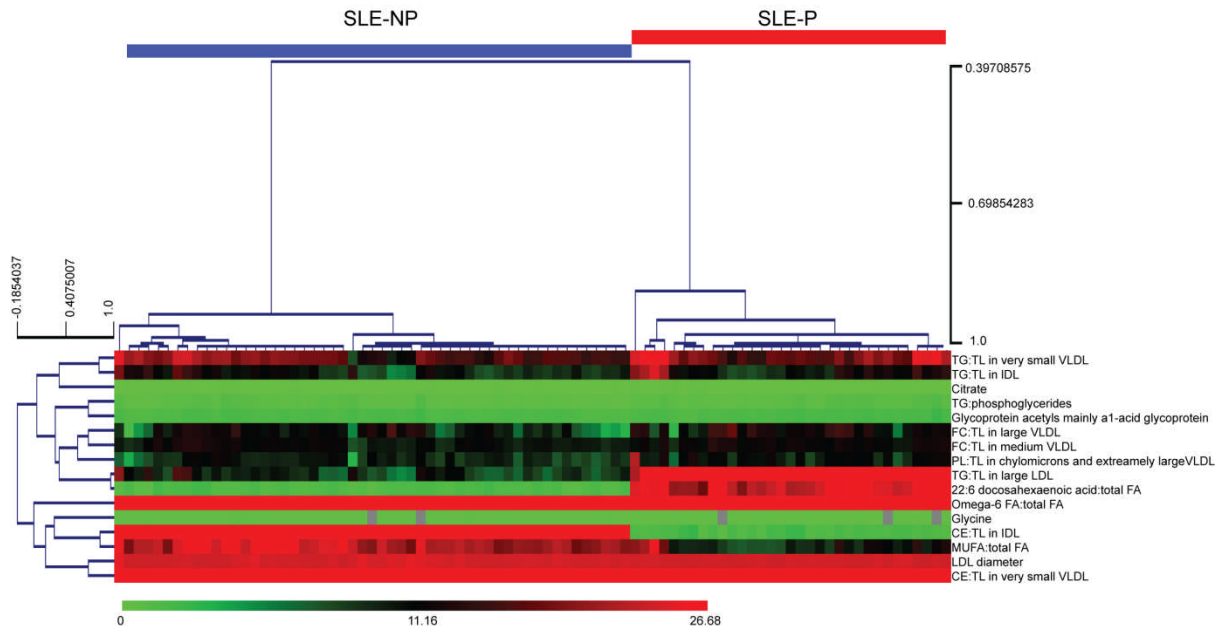

Figure S4: Hierarchical clustering of metabolites with most significant differences between SLE-NP and SLE-P patients. Serum samples taken at the time of femoral and carotid ultrasound scan from 33 SLE patients with plaque (SLE-P) and 53 patients with no plaque (SLE-NP) were assessed by proton nuclear magnetic resonance spectroscopy for 230 serum lipid metabolites. Hierarchical clustering was performed using Multiexperiment Viewer 4.9 (TM4). Dendrogram showing clustering of metabolites with significantly altered expression in serum from SLE-NP and SLE-P patients ($p < 0.05$ as determined by student's t test. Red= high expression; green=low expression).

Figure S5

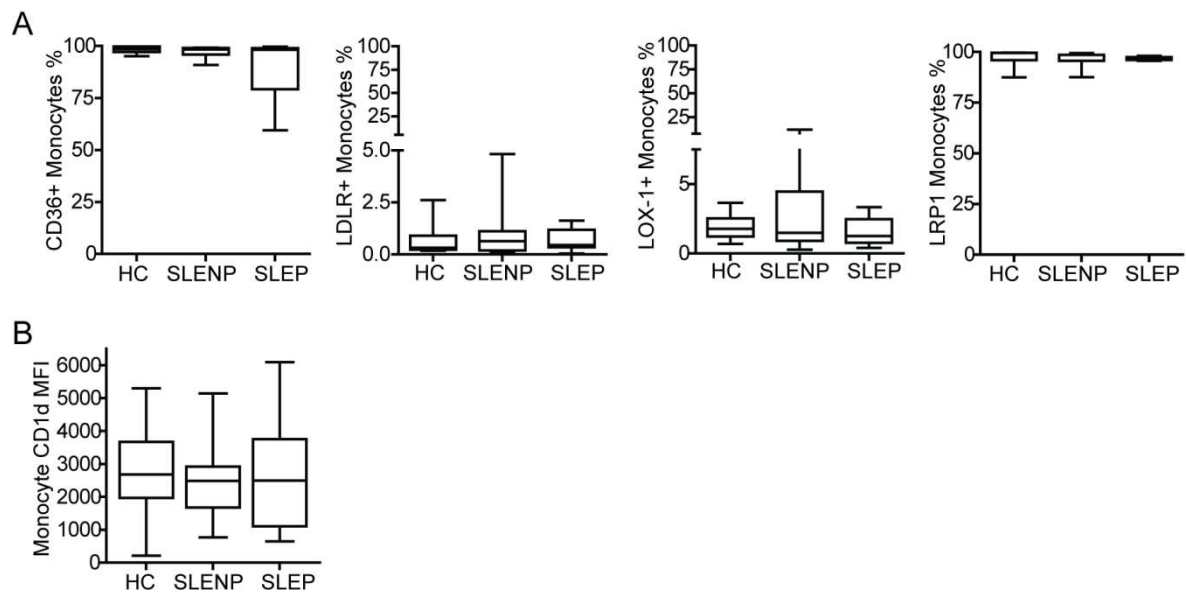

Fig. S5: Monocyte/macrophage phenotype in SLE-P, SLE-NP patients and healthy donors. 10^6 PBMCs from 14 healthy donors, 15 SLE-NP and 10 SLE-P patients were surface stained *ex vivo* for CD14, CD36, LDLR, LOX-1, LRP-1 and CD1d and analysed by flow cytometry. **(A)** Percentage of monocytes positive for CD36, LDLR, LOX-1 and LRP-1. **(B)** Expression of CD1d on monocytes (MFI). Box and whisker plots. No significant differences detected between groups.

Figure S6

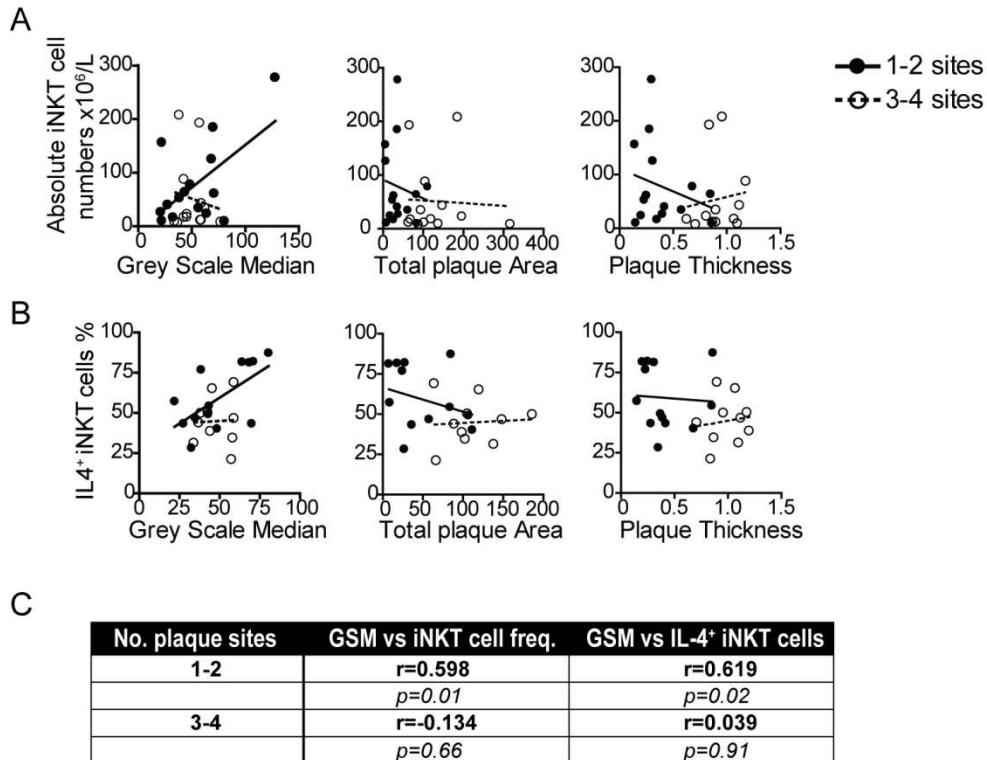

Figure S6: iNKT cell frequency and IL4 production correlates with plaque stability measured by Grey Scale Median (GSM).

Plaque echogenicity was expressed numerically by the Grey Scale Median (GSM) value (see supplemental methods). Echolucent plaques have a low GSM score and are unstable and lipid rich (7), less echolucent plaques have a higher GSM score and are more stable. 28 SLE-P patients were stratified according to number of plaque sites; 1-2 plaque sites (n=15) and >3 plaque sites (n=13). iNKT cell frequency (**A**) and frequency of iNKT cells producing IL-4 (**B**) were correlated with GSM (assessing plaque echolucency), total plaque area and plaque thickness. (**C**) Pearsons correlation (r) and significance (p) of the correlation for GSM is shown. No other significant correlations were observed.

Figure S7

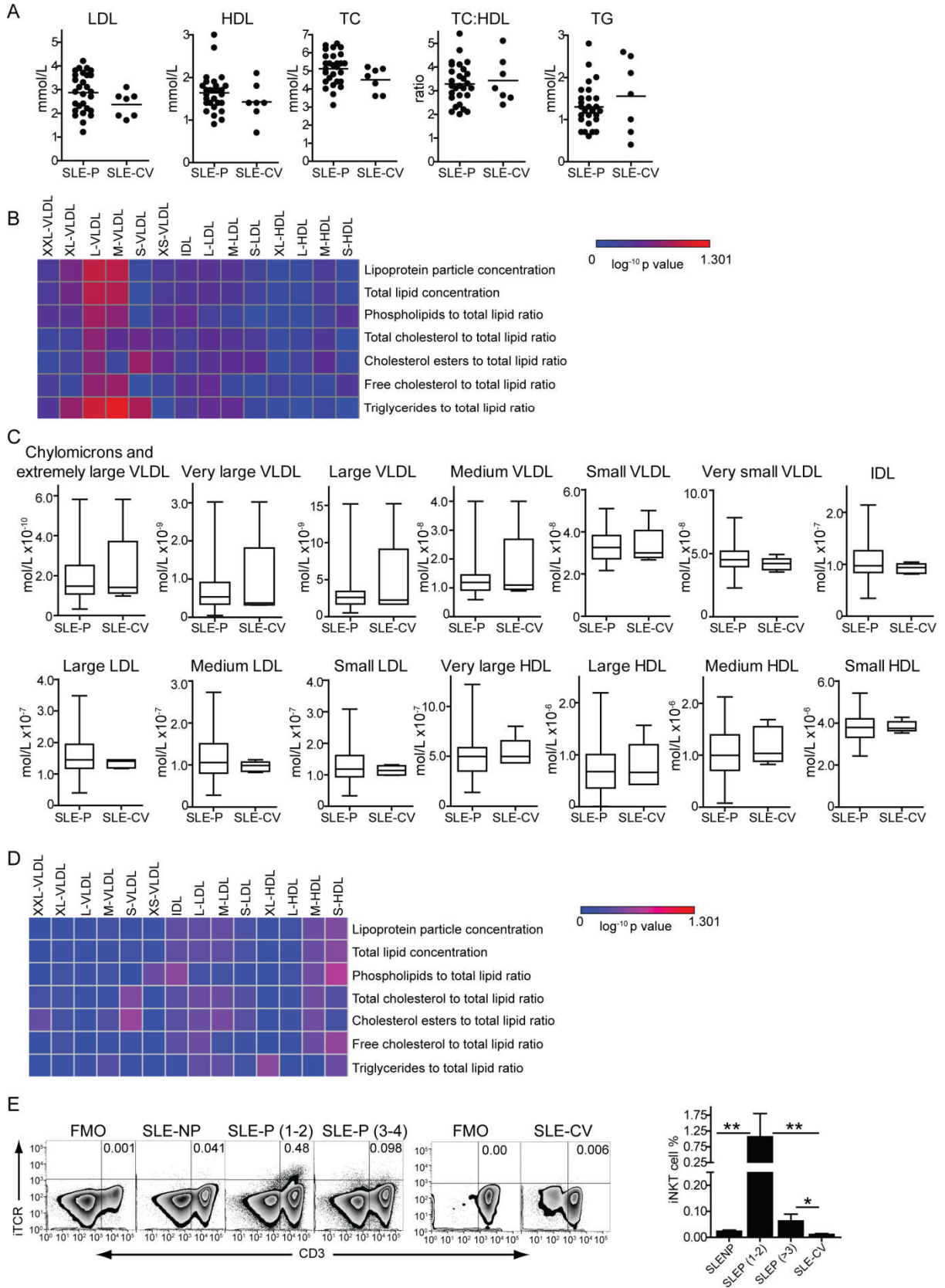

Figure S7: A-D Stratification of serum lipid profiles in SLE-P and SLE-CV patients.

(A). SLE patients who had previously suffered a cardiovascular event were identified from a cohort of over 500 SLE patients who fulfilled the revised classification criteria for SLE (refer to table S6). Standard serum lipid measurements were compared between the SLE-P (n=33) and SLE-CV (n=7) groups. Scatterplots showing mean. Unpaired t tests show no significant differences between the groups.

Serum samples from 33 SLE-P and 5 SLE-CV patients were assessed by proton nuclear magnetic resonance spectroscopy for 230 serum lipid metabolites. (B) Lipoprotein size and composition between SLE-P and SLE-CV patients compared using a Students T test, converted into \log^{-10} p values and plotted as a heat map. Maximum red colour on scale bar represents $p=0.05$. (C) Box and whisker plots show a comparison of lipoprotein particle levels. Multiple unpaired t tests show no significant differences between the groups. HDL, high density lipoprotein; LDL, low density lipoprotein; IDL intermediate density lipoprotein; VLDL, very low density lipoprotein; SLE-P, SLE patients with plaque; SLE-NP, SLE patients without plaque; TG, triglycerides; TC, total cholesterol.

(D) Metabolomics data from 33 SLE-P patients was stratified according to number of plaque sites; 1&2 sites vs. 3&4 sites. Data were compared using a Students T test, converted into \log^{-10} p values and plotted as a heat map. Maximum red colour on scale bar represents $p=0.05$. No significant differences were identified.

Figure S7E: Stratification of *i*NKT cell response to *in vitro* α -GalCer stimulation in SLE-P and SLE-CV patients. PBMCs from six SLE-NP, five SLE-P patients with 1-2 plaque sites (SLE-P (1-2)), four SLE-P patients with over 3 plaque sites (SLE-P>3) and five SLE-CV patients were stimulated for 7d with α -GalCer and IL-2. Representative dotplots (including FMO control for iTCR staining) and cumulative data are shown. Data analyzed using Kruskal-Wallis test ($p=0.002$) and multiple T-tests: SLE-NP vs SLE-P (1-2), $*=0.004$; SLE-P (1-2) vs SLE-CV, $*p=0.007$; SLE-P (3-4) vs SLE-CV, $*p=0.015$.

SUPPLEMENTARY TABLES

Table S1: SLE patient and Healthy donor characteristics

	Healthy donors (n=50)	SLE-NP (n=64)	SLE-P (n=36)	ANOVA
Mean Age (range)	39 (22-67)	40 (20-66)	54 (27-69)	¹ HC vs SLEP p<0.001* ¹ SLENP vs SLEP p<0.001*
Years since diagnosis (range)	NA	13 (2-32)	21 (2-46)	¹ P=0.0008*
Sex: female: male	47:3	62:2	33:3	¹ NS
Ethnicity: C/A/AC/O (%)	40/4/6/0 (80: 7: 13: 0)	33/9/17/5 (51.6/14.1/26.6/7.8)	24/2/7/3 (66.6/5.5/19.4/4.7)	¹ H vs SLE-NP p<0.05* ¹ H vs SLE-P p<0.05*
Smoking (%)	4 (8)	5 (7.8)	6 (16.7)	¹ NS
Personal history of CVD (%)	0	0	0	¹ NS
Mean Right CCA IMT (range)	ND	0.510 (0.04-0.08)	0.057 (0.04-0.08)	² 0.002*
Mean Right Bulb IMT (range)	ND	0.080 (0.05-0.12)	0.178 (0.07-0.42)	² <0.0001*
Mean Left CCA (range)	ND	0.061 (0.04-0.06)	0.061 (0.05-0.10)	² <0.0001*
Mean Left Bulb (range)	ND	0.078 (0.05-0.13)	0.196 (0.07-0.35)	² <0.0001*
Mean total arterial score (range)	ND	3.59 (0-8)	16.97 (6-26)	² <0.0001*
Systolic blood pressure/mmHg (range)	ND	122.9 (94-166)	132.3 (108-168)	² p=0.0045*
Diastolic blood pressure/mmHg (range)	ND	76.1 (57-109)	75.1 (55-96)	² p=0.651
Pulse Pressure/mmHg (range)	ND	46.8 (25-72)	57.1 (30-81)	² p<0.0001*
Mean blood pressure/mmHg (range)	ND	91.7 (70-125)	94.1 (77-115)	² p=0.288
Statins (%)	0 (0)	6 (9.4)	7 (18.9)	² p=0.394
ACE Inhibitor (%)	0 (0)	23 (35.9)	12 (33.3)	² p=0.830
Aspirin (%)	0 (0)	7 (10.9)	7 (19.4)	² p=0.483
Hydroxychloroquine (HCQ) (%)	0 (0)	42 (65.6)	23 (63.8)	² p=0.863
Pred ≥10mg/day (%)	0 (0)	9 (14.1)	5 (13.9)	² p=0.991
Pred <10mg/day (%)	0 (0)	33 (51.5)	17 (47.2)	² p=0.885
HCQ + disease modifying agents (%)	0 (0)	22 (34.2)	6 (16.7)	² p=0.060
Pred + disease modifying agents (%)	0 (0)	26 (40.6)	13 (36.1)	² p=0.707
Rituximab (%)	0(0)	18 (28.1)	9 (25.0)	² P=0.737
Global BILAG score at time of scan (range)	NA	4.46 (0 – 17)	3.94 (0 – 32)	² p=0.655
Persistently active (%)	NA	26 (40.6)	22 (61.1)	² P=0.112
Median anti-dsDNA antibodies (range)	NA	89.97 (1-688)	109.0 (1-712)	² p=0.192
Median C3 (range) g/L	NA	0.99 (0.49-1.42)	1.026 (0.69-1.46)	² p=0.643

Table S1: SLE patient and healthy donor characteristics: 100 SLE patients fulfilling the revised classification criteria for SLE and who had not previously suffered a cardiovascular event were scanned to determine the presence of plaque. Vascular ultrasound of the common carotid artery (CCA), carotid bulb, carotid bifurcation, common femoral artery (CFA) and femoral bifurcation were performed bilaterally by Dr Sara Croca and Prof Andrew Nicolaides and using the Philips IU22 ultrasound computer and the L9-3 MHz probe. IMT measurements were performed using QLAB Advanced Quantification Software® version 7.1 (Philips Ultrasound, Bothell, USA). Each plaque site was scored (0-8) and combined to give a total arterial score. At the time of the scan patients were assessed for smoking, blood pressure, medication and serum concentrations of anti-double stranded (ds)DNA antibodies and complement protein C3. Disease activity was assessed using the British Isles Lupus Assessment Group index (BILAG). The BILAG activity index distinguishes activity in 9 organs/systems. Patients with active SLE disease have a BILAG global score >6. Patients with persistently active disease were identified as having a Global BILAG score >5 in at least two consecutive visits from the last four visits. Data expressed as mean except for anti-double stranded (ds)-DNA antibody and C3 levels. 50 healthy donors were also recruited to the study. Healthy donors were not scanned for plaque but demographic information was collected. Data were analysed using either a One-way ANOVA¹ or Mann Whitney² test for significance using a 95% confidence interval. *denotes significant results. ACE, angiotensin-converting-enzyme; C/A/AC/O, Caucasian/Asian/Afro-Caribbean/Other; CCA, common carotid artery; CFA, common femoral artery; CVD, cardiovascular disease; HCQ, hydroxychloroquine;. IMT, intima-media thickness; NA= not applicable; ND= not done; NS=not significant; Pred, prednisolone; SLE-P; SLE patients with plaque; SLE-NP; SLE patients without plaque.

Table S2: Plasma cytokine levels measured by proteomic analysis in in SLE patients with pre-clinical plaque compared to those without plaque

	SLE-NP (n=8)	SLE-P (n=8)	P-value	q value
	<i>Relative fluorescence units</i>			
IL-1a	1633 (651-3888)	1155 (895-1346)	0.334	0.799
IL-1b	6282 (1167-15879)	4001 (1333-17372)	0.416	0.799
IL-1F6	3000 (1117-6321)	3161 (1635-7001)	0.869	0.968
IL-1F8	1468 (401-5601)	456 (291-1050)	0.121	0.762
IL-1F7	2311 (1827-2861)	2545 (1881-4556)	0.500	0.799
IL-2	1370 (1040-1801)	1578 (1122-2433)	0.286	0.799
IL-3	1223 (811-1609)	1477 (823-2114)	0.156	0.762
IL-4	954 (729-1425)	909 (778-1081)	0.600	0.868
IL-5	230 (162-407)	235 (152-551)	0.926	0.972
IL-6	2035 (1470-3112)	1620 (915-2698)	0.123	0.762
IL-7	173 (81-284)	204 (78-825)	0.750	0.920
IL-8	1134 (690-1751)	1319 (688-2037)	0.396	0.799
IL-9	373 (247-618)	404 (177-935)	0.776	0.920
IL-10	234 (123-444)	377 (112-1594)	0.449	0.799
IL-11	2127 (847-4180)	1324 (672-3188)	0.168	0.762
IL-12	450 (141-737)	240 (135-364)	0.031	0.716
IL-13	1716 (1053-2487)	1429 (969-2961)	0.360	0.799
IL-16	339 (250-461)	288 (239-374)	0.139	0.762
IL-17	1022 (491-2334)	702 (398-1403)	0.217	0.762
IL-17B	171 (72-430)	201 (61-984)	0.808	0.927
IL-17D	590 (179-1806)	443 (160-1447)	0.561	0.858
IL-17E	518 (373-740)	561 (289-1034)	0.698	0.920
IL-17F	401 (225-865)	590 (329-1425)	0.228	0.762
IL-18 Ra	9965 (3199-20931)	11279 (5156-17446)	0.614	0.868
IL-18 Rb	603 (414-859)	534 (335-859)	0.482	0.799

IL-18 BPa	7614 (1711-19535)	9874 (4068-23367)	0.478	0.799
IL-19	4045 (2263-6212)	4859 (3321-7178)	0.198	0.762
IL-20	677 (444-970)	690 (304-1126)	0.901	0.972
IL-22	1328 (748-1688)	7040 (1100-45776)	0.320	0.799
IL-23	1220 (757-2530)	816 (450-1086)	0.084	0.762
IL-24	1036 (629-1548)	743 (502-875)	0.039	0.716
IL-27	786 (628-936)	885 (649-1394)	0.303	0.799
IL-34	481 (390-642)	506 (414-983)	0.749	0.920
TNF-a	601 (364-1235)	850 (346-2246)	0.442	0.799
BAFF	1789 (949-4755)	1652 (1230-2459)	0.772	0.920

Table S2: Plasma cytokine levels measured by proteomic analysis in in SLE patients with pre-clinical plaque compared to those without plaque. Plasma from 8 SLE-P and 8 SLE-NP patients were analysed by Somologic proteomic analysis (see supplemental methods). Of 1322 proteins tested, cytokines, and IL-18 associated proteins were selected for analysis. P-values were adjusted for a false discovery rate (FDR) of 5% using the two-stage linear step-up procedure of Benjamini, Krieger and Yekutieli in GraphPad Prism 7.01. No results were significant after adjusting for false discovery.

Table S3: Serum metabolites significantly altered in SLE patients with pre-clinical plaque compared to those without plaque

Metabolite	SLE-NP mean (range)	SLE-P mean (range)	<i>p</i> value
Free cholesterol to total lipids ratio in medium VLDL	10.89 (7.61-13.38)	11.61 (9.18-13.67)	0.00113
Glycine	0.297 (0.196-0.438)	0.265 (0.198-0.347)	0.0027
Free cholesterol to total lipids ratio in large VLDL	9.82 (1.54-15.98)	12.01 (2.72-17.58)	0.00231
Phospholipids to total lipids ratio in chylomicrons and extremely large VLDL	9.31 (2.96-12.12)	10.87 (6.48-22.33)	0.00403
Triglycerides to total lipids ratio in very small VLDL	17.37 (7.75-25.29)	19.44 (12.96-29.48)	0.0103
Mean diameter for LDL particles	24.06 (23.55-25.13)	23.89 (23.47-24.46)	0.0129
Ratio of omega-6 fatty acids to total fatty acids	33.65 (26.17-41.2)	32.15 (26.49-38.67)	0.0162
Triglycerides to total lipids ratio in IDL	17.37 (5.22-18.73)	12.24 (7.61-24.59)	0.0165
Ratio of triglycerides to phosphoglycerides	0.51 (0.25-1.21)	0.61 (0.32-1.27)	0.0183
Ratio of 22:6 docosahexaenoic acid to total fatty acids	1.24 (0.54-1.97)	1.42 (0.49-2.54)	0.0217
Glycoprotein acetyls (mainly a1-acid glycoprotein)	0.074 (0.039-0.1332)	1.52 (1.09-2.43)	0.029
Ratio of monounsaturated fatty acids to total fatty acids	22.9 (17.92-30.05)	24.2 (17.9-29.3)	0.0307
Triglycerides to total lipids ratio in large LDL	9.54 (5.18-19.92)	11.23 (7.25-26.01)	0.0317
Cholesterol esters to total lipids ratio in IDL	46.66 (38.18-62.11)	44.54 (21.71-49.66)	0.0338
Cholesterol esters to total lipids ratio in very small VLDL	43.6 (33.5-61.0)	41.4 (21.5-51.7)	0.0358
Citrate	1.42 (1.02-2.01)	0.05 (0.036-0.103)	0.045

Table S3: Serum metabolites significantly altered in SLE patients with pre-clinical plaque compared to those without plaque. Serum samples taken at the time of femoral and carotid ultrasound scan from 33 SLE patients with carotid or femoral plaque (SLE-P) and 53 patients with no plaque (SLE-NP) were assessed for 230 metabolomics by proton nuclear magnetic resonance (NMR) spectroscopy. Proportions of total serum cholesterol, phospholipids and triglycerides carried by each lipoprotein subclass and other serum metabolites were determined (6). Table lists the markers showing significant differences between SLE patients with and without plaque using Students T test a 95% confidence interval (no significance was seen using the Bonferoni correction). HDL, high density lipoprotein; LDL, low density lipoprotein; IDL intermediate density lipoprotein; VLDL, very low density lipoprotein; SLE-P, SLE patients with plaque; SLE-NP, SLE patients without plaque.

Table S4: SLE patient serum lipids and biomarkers

	SLE-NP (n=64)	SLE-P (n=36)	P value
Mean CRP mg/dL (range) NR <5	6 (0.6-7.7)	3.44 (0-15.5)	p=0.261
Mean Homocysteine μmol/L (range) NR 6-15	13.98 (9-17.5)	16.92 (9-38)	p=0.055
Mean Creatinine μmol/L (range) NR 53-115	71.28 (42-227)	55.79 (40-184)	p=0.311
Mean Vitamin D nmol/L (range) NR 25-137	63.06 (14-228)	55.79 (7-114)	p=0.619
Mean Total Cholesterol mmol/L (range) NR<5.2	4.67 (2.5 – 7.3)	5.04 (2.9 – 6.5)	p=0.067
Mean Triglycerides mmol/L (range) NR<2.2	1.01 (0.4 – 2.3)	1.31 (0.6 – 2.8)	p=0.002*
Mean HDL mmol/L (range) NR >1.0	1.71 (0.8 – 2.7)	1.60 (0.8 – 3.0)	p=0.289
Mean LDL mmol/L (range) NR <2.0	2.49 (0.8 – 4.8)	2.84 (1.2 – 4.2)	p=0.084
Cholesterol: HDL ratio (range) NR <3.5	2.87 (1.6 – 5.2)	3.38 (1.8 – 5.6)	p=0.008*

Table S4: SLE patient serum lipids and biomarkers: 100 SLE patients fulfilling the revised classification criteria for SLE were scanned to determine the presence of plaque. Patient blood samples from the time of the scan were assessed for a range of biomarkers including C reactive protein (CRP), homocysteine, creatinine, vitamin D and serum lipids. For creatinine, only 11 patients (5/64 SLE-NP and 6/36 SLE-P) had creatinine levels outside the normal range for our hospital. Data were analysed by a two-tailed T test for significance using a 95% confidence interval. *denotes significant results. HDL, high density lipoprotein, LDL, low density lipoprotein, SLE-P, SLE patients with plaque; SLE-NP, SLE patients without plaque.

Table S5: Correlation of serum metabolites with *i*NKT cell frequency and IL-4 production in SLE-P and SLE-NP patients

Metabolite	Correlation with <i>i</i> NKT cell absolute number: Pearson's correlation coefficient <i>r</i> and (p value)		Correlation with <i>i</i> NKT cell intracellular IL-4: Pearson's correlation coefficient <i>r</i> and (p value)	
	SLE-NP	SLE-P	SLE-NP	SLE-P
Free cholesterol to total lipids ratio in medium VLDL	0.0729 (0.7350)	-0.4950 (0.0087)*	-0.3646 (0.1502)	0.1873 (0.4039)
Glycine	0.2747 (0.1940)	0.7005 (0.0053)*	-0.1342 (0.5956)	-0.2539 (0.2543)
Free cholesterol to total lipids ratio in large VLDL	-0.1169 (0.5684)	-0.5135 (0.0350)*	-0.05266 (0.8356)	0.3801 (0.0810)
Phospholipids to total lipids ratio in chylomicrons and extremely large VLDL	-0.1275 (0.5528)	-0.5948 (0.0092)*	-0.1193 (0.6485)	-0.05080 (0.8137)
Triglycerides to total lipids ratio in very small VLDL	0.01406 (0.9480)	-0.3285 (0.1832)	-0.2211 (0.3779)	-0.01551 (0.9426)
Mean diameter for LDL particles	0.07357 (0.7326)	-0.2659 (0.2862)	0.2961 (0.2328)	-0.1291 (0.5477)
Ratio of omega-6 fatty acids to total fatty acids	0.2004 (0.3478)	0.5610 (0.0154)*	0.1217 (0.6305)	-0.3340 (0.1288)
Triglycerides to total lipids ratio in IDL	0.06820 (0.7515)	-0.2858 (0.2661)	-0.3136 (0.2051)	-0.01551 (0.9426)
Ratio of triglycerides to phosphoglycerides	-0.04249 (0.8437)	-0.3621 (0.1398)	-0.3255 (0.2023)	0.7954 (<0.0001)*
Ratio of 22:6 docosahexaenoic acid to total fatty acids	0.2976 (0.1578)	0.3857 (0.1139)	-0.00268 (0.9916)	-0.5275 (0.0116)*
Glycoprotein acetyls (mainly a1-acid glycoprotein)	-0.1798 (0.4005)	0.1861 (0.3628)	-0.0944 (0.7095)	0.3720 (0.0734)
Ratio of monounsaturated fatty acids to total fatty acids	-0.03111 (0.8853)	-0.5570 (0.0163)*	-0.3282 (0.1837)	0.4555 (0.0332)*

Triglycerides to total lipids ratio in large LDL	0.02350 (0.9132)	-0.2727 (0.2896)	-0.3136 (0.2051)	-0.1364 (0.5252)
Cholesterol esters to total lipids ratio in IDL	-0.1044 (0.6274)	0.005076 (0.9841)	0.3029 (0.2373)	0.2659 (0.2092)
Cholesterol esters to total lipids ratio in very small VLDL	-0.04726 (0.8264)	-0.2168 (0.3874)	0.3486 (0.1562)	0.3179 (0.1393)
Citrate	0.3126 (0.1370)	-0.0478 (0.8054)	-0.5179 (0.0277)*	-0.1229 (0.5672)

Table S5: Correlation of serum metabolites with *i*NKT cell frequency and IL-4 production in SLE-P and SLE-NP patients. Correlations between serum metabolites found statistically significantly different between SLE-NP and SLE-P patients shown in Table S2 and *i*NKT cell frequency and IL4 production. Correlations were calculated using Pearson's correlation coefficient (r) and significance was determined using a 95% confidence interval. * denotes statistically significant result. SLE-P= SLE patients with plaque; SLE-NP=SLE patients without plaque.

Table S6: SLE cardiovascular event (SLE-CV) patient clinical characteristics

	SLE-CV patients (n=11)
Mean Age (range)	50 (20-78)
Years since SLE diagnosis (range)	18 (1-34)
Sex: female: male (%)	9: 2 (82/18)
Ethnicity: C/A/AC/O (%)	8/1/1/1 (73/9/9/9)
Smoking (%)	1 (9.09)
Statins (%)	3 (27.27)
Anti-hypertensives (%)	6 (54.54)
Aspirin (%)	1 (9.09)
Hydroxychloroquine (%)	5 (45.45)
Pred \geq 10mg/day (%)	1 (9.09)
Pred <10mg/day (%)	7 (63.63)
HCQ + disease modifying agents (%)	3 (27.27)
Pred + disease modifying agents (%)	7 (63.63)
Rituximab (%)	0 (0)
Global BILAG score (range)	4.17 (0-10)
Mean Total Cholesterol mmol/L (range) NR<5.2	4.50 (3.6-5.2)
Mean Triglycerides mmol/L (range) NR<2.2	1.56 (0.4-2.6)
Mean HDL mmol/L (range) NR >1.0	1.43 (0.7-2.1)
Mean LDL mmol/L (range) NR <2.0	2.37 (1.7-3.1)
Cholesterol: HDL ratio (range) NR <3.5	3.43 (2.4-5.1)

Table S6: SLE cardiovascular event (SLE-CV) patient clinical characteristics: SLE patients who had previously suffered a cardiovascular event (myocardial infarction confirmed by ECG and enzyme rise, ischaemic stroke confirmed by imaging of the brain or coronary artery disease confirmed by angiography) were identified from a cohort of over 500 SLE patients who fulfilled the revised classification criteria for SLE. Of these 11 patients, six had coronary events, and five had ischaemic strokes. For 7 patients the sample tested had been taken within five years of the CV event. Patients donated blood at the time of the visit where they were assessed for smoking, medication, serum lipids and disease activity, measured by BILAG score. Patients with active SLE disease have a BILAG global score >6. Unlike SLE-NP and SLE-P patients, SLE-CV patients were not scanned for plaque.

Experimental data

Experimental data

Figure 1

1 G Transcription factors														
GATA3 MFI	Healthy		SLENP		SLEP		T-Bet MFI		Healthy		SLENP		SLEP	
		31.5	731	848					2266	8874	9096			
	3.77	264	469					925	2781	4393				
	5.67	1	789					1045	3834	975				
			679							2197				
			47.7							2195				

1H a-GalCer stimulation							1I a-GalCer stimulation			1J a-GalCer stimulation			iNKT frequency fold change			
Ki-67 MFI	HC		SLE-NP		SLE-P		Ki-67	HC		SLE-NP		SLE-P		HC	SLENP	SLEP
		d0	d7	d0	d7	d0		d7								
								11399	10785	48636				16.92308	0.018881	11.47541
	75391	11399	9734	10785	4202	48636		145223	10701	3562				10.85714	0.182353	1.149254
	6733	145223	95578	10701	34918	3562			3932	10869				1.833333	0.032394	0.64045
	85060	182159	214622	3932	17639	10869			12011	8450				3.488372	6	2.298851
	60873	235549	41918	12011	56093	101347		182159	9732	101347					2.827586	44.46154
	51951	163343	14336	9732	57942	257571		235549	6219	257571					5	2.594594
	20278	80661	8356	6219	61551	141677		163343	69901	9852					5.543478	9.375
			53760	69901	27370	63851		80661	5596	141677						1.76087
			32715	5596	1626	9852				63851						

1K Co-stimulatory molecules												
------------------------------------	--	--	--	--	--	--	--	--	--	--	--	--

ICOS-MFI	Healthy	SLE-NP	SLE-P	CD40-L MFI	Healthy	SLE-NP	SLE-P
	819	536	772		543	13.2	784
	664	384	855		264	291	962
	696	611	711		127	404	345
		380	1077			1879	589
		693	1015			320	327

Figure2B	HC 1							HD2						
	d0	HC d4	HC d7	SLE NP d4	SLE NP d7	SLE P d4	SLE P d7	d0	HC d4	HC d7	SLE NP d4	SLE NP d7	SLE P d4	SLE P d7
	0.033	0.033	0.092	0.057	0.1	0.047	0.41	0.11	0.14	0.12	0.13	0.12	0.21	0.25
		0.11	0.1	0.044	0.09	0.048	0.18		0.14	0.1	0.072	0.054	0.13	0.14
		0.078	0.11	0.039	0.17	0.074	0.25		0.13	0.12	0.15	0.094	0.11	0.14
		0.055	0.11	0.021	0.14	0.055	0.17		0.16	0.11		0.079		0.21
		0.057	0.083	0.064	0.071	0.038	0.13		0.19	0.11	0.083	0.066		0.17
Mean	0.033	0.0666	0.099	0.045	0.1142	0.0524	0.228	0.11	0.152	0.112	0.10875	0.0826	0.15	0.182

HD3							HD4						
d0	HC d4	HC d7	SLE NP d4	SLE NP d7	SLE P d4	SLE P d7	d0	HC d4	HC d7	SLE NP d4	SLE NP d7	SLE P d4	SLE P d7
0.035	0.032	0.00899	0.024	0.04	0.032	0.083	0.064	0.11	0.064	0.085	0.034	0.091	0.085
	0.04	0.016	0.02	0.052	0.02			0.11	0.089	0.11	0.098	0.087	0.075
	0.023	0.011	0.031	0.023	0.0093	0.032		0.097	0.087	0.093	0.067	0.072	0.087
	0.023	0.00944	0.016	0.016	0.034	0.03			0.084	0.044	0.05	0.12	0.15
			0.017	0.00483	0.029	0.11							
0.035	0.0295	0.01136	0.0216	0.02717	0.02486	0.06375	0.064	0.10567	0.081	0.083	0.06225	0.0925	0.09925

Figure 2C	HC	SLE-NP	SLE-P
	233.3333	115.1515	293.9394

233.3333	9.090909	127.2727	
151.5152	-50.9091	27.27273	
9.090909	-14.5455	27.27273	
-9.09091	-28.1818	90.90909	
9.090909	-40	54.54546	
0	-46.875	32.8125	
0	53.125	17.1875	
71.875	4.6875	35.9375	
39.0625	-21.875	134.375	
35.9375	14.28571	137.1429	
31.25	48.57143	-8.57143	
-74.3143	-34.2857	-14.2857	
-54.2857	-54.2857	214.2857	
-68.5714	-86.2	91.42857	
-73.0286	-75.7429		
mean	33.4499	-12.9993	84.1016

Figure 2D	iNKT+IL-4+ %			Figure 2E	anti-CD1d					
	HC	SLE-NP	SLE-P		HC	HC + 1D	SLENP	SLENP + 1D	SLEP	SLEP +1D
	22.94	18.8	17.41	0.01	0.00874	0.04	0.026	0.083	0.07	
	21.4	0	31.3	0.016	0.014	0.052	0.00821	0.49	0.011	
	20.7	0	68.2	0.011	0.013	0.023	0.025	0.182	0.01	
	48.4	15.8	21.99			0.024	0.015	0.053	0.032	
	22.58	27.3	33.3			0.02	0.014	0.02	0.00729	
	19.56	11.1	22.7			0.031	0.00541	0.093	0.026	
	57.14	33.3	29.55	mean	0.01233	0.01191	0.03167	0.0156	0.1535	0.02605
	33.45	14.6	34.09							
	43.9	12.59	45.1							
	29.06	45.5	63.6							
mean	31.913	17.899	36.724							

Figure 2K	Monocytes						B cells					
	serum			VLDL/LDL			serum			VLDL/LDL		
	HC	SLE-NP	SLE-P	HC	SLE-NP	SLE-P	HC	SLE-NP	SLE-P	HC	SLE-NP	SLE-P
	1243	5162	1.24E+03	5173	13594	6276	1023	1060	1084	1164	1268	1160
	1065	5127	1412	5901	15692	6674	1060	1392	1116	1228	1390	1178
	996	3882	1453	5618	11949	7258	1085	1004	1025	1107	1255	1147

Figure 3B	iNKT cell frequency %													
B cells	Fraction 1			Fraction 2		Fraction 3		Fraction 4		Fraction 5		Fraction 6		
	Day 0	Day 4	Day 7	Day 4	Day 7	Day 4	Day 7	Day 4	Day 7	Day 4	Day 7	Day 4	Day 7	
	0.03	0.085	0.072	0.016	0.005	0.033	0.012	0.015	0.015	0.068	0.061	0.089	0.021	
		0.054	0.076	0.016	0.01	0.003	0.011	0.055	0.094	0.018	0.34	0.018	0.047	
		0.047	0.061	0.018	0.11	0.018	0.09	N/A	0.062	0.00322	0.17	0.056	0.025	
		0.06	0.066	0.058	0.068	0.08	0.039	0.035	0.042	0.058	0.041	N/A	0.12	
										0.089			0.08	
mean	0.03	0.0615	0.06875	0.027	0.04825	0.0335	0.038	0.035	0.05325	0.03681	0.1402	0.05433	0.0586	

iNKT cell frequency %														
Monocytes	Fraction 1			Fraction 2		Fraction 3		Fraction 4		Fraction 5		Fraction 6		
	Day 0	Day 4	Day 7	Day 4	Day 7	Day 4	Day 7	Day 4	Day 7	Day 4	Day 7	Day 4	Day 7	
	0.03	0.065	0.067	0.016	0.006	0.044	0.019	0.016	0.016	0.037	0.11	0.054	0.022	
		0.097	0.016	0.008	0.013	0.005	0.012	0.05	0.097	0.021	0.15	0.051	0.082	
		0.061	0.082	0.013	0.12	0.019	0.087	N/A	0.07	0.00463	0.23	0.064	0.046	
		0.06	0.045	0.067	0.073	0.055	0.058	N/A	0.049	0.063	0.15	N/A	0.086	
													0.057	
Mean	0.03	0.07075	0.0525	0.026	0.053	0.03075	0.044	0.033	0.058	0.03141	0.16	0.05633	0.0586	

Figure 3D Fraction 5 lipids isolated from:

	DMSO	a-GalCer	Healthy monocytes	SLE-NP monocytes	SLE-P monocytes	Healthy B cells	SLE-NP B cells	SLE-P B cells
	0.17	0.091	0.15	0.067	0.13	0.061	0.053	0.08
		0.021	0.15	0.099	0.15	0.17	0.1	0.13
	0.075	0.058	0.13	0.059	0.074	0.051	0.071	0.065
	0.13	0.084	0.15	0.12	0.14	0.089	0.084	0.09
	0.31	0.026	0.15	0.077	0.096	0.061	0.039	0.065
			0.11			0.34		
			0.13			0.17		
						0.13		
						0.089		
mean	0.17125	0.056	0.1385714	0.0844	0.118	0.129	0.0694	0.086

Figure 3 E Cytokines in 7d tissue culture supernatants

IL-4 pg/ml	HC	SLE-NP	SLE-P	IL-13pg/ml	HC	SLE-NP	SLE-P
1	2.13	0.69	2.42	1	314.34	272.7	288.84
2	1.66	0.97	2.06	2	21.61	16.02	230.83
3	0	0	2.35	3	107.85	50.28	630.81
4				4	32.41	60.72	246.19
5				5	120.98	120.5	175.69
mean	1.263	0.5533	2.277	mean	119.4	104	314.5
SE	0.6461	0.2882	0.1102	SE	52.57	45.4	81.13

IFN-g pg/ml

1	203.55	2135.15	192.98
2	3485.16	6650.06	1602.34
3	2149.15	12930.38	663.9
4	1097.91	10272.01	251.71
5	1070.89	2192.29	1077.54

<i>mean</i>	1601.33	6835.98	757.694
<i>SE</i>	562.9	2152	264.5

Figure 3G

IL-4 pg/ml	F5 lipid +isotype ab	F5 lipid +anti-CD1d	IL-13 pg/ml	F5 lipid +isotype ab	F5 lipid +anti-CD1d	IFN-g pg/ml	F5 lipid +isotype ab	F5 lipid +anti-CD1d
1	1.23	0	1	428.45	15.04	1	531.4	3760.36
2	2.13	0	2	314.34	12.2	2	203.55	6767.22
3	2.03	0	3	120.5	9.79	3	643.55	606.61
4	0.69	0	4	272.7	11.11	4	2135.15	1997.55
5	1.23	0	5	120.98	8.61	5	251.71	1663.91
6	2.42	1.1	6	248.84	50.86	6	192.98	7554.73
<i>mean</i>	1.62167	0.18333	<i>mean</i>	250.968	17.935	<i>mean</i>	659.723	3725.06

Figure 4H

CD206MFI			CD206%		
Healthy	SLENP	SLEP	Healthy	SLENP	SLEP
20615	10570	19776	33.2	14.6	29.4
40064	21503	20663	66.7	33.5	30.5
45641	25697	60035	56.1	45.1	73.7
11951	16305	14432	14.6	25	23.9
19038	25067	24703	28.5	38.9	43.9
19910	24753	17955	44.6	35.9	23

Figure 4J M2 macrophage %: T cell/monocyte co-culture with HC, SLE-NP and SLE-P serum

HC	SLE-NP	SLE-P
14.3	22.4	38.5
15.4	29.5	36.9
7.79	17.3	37.07

Mean	12.5	23.07	37.49
SEM	2.375	3.538	0.5074

Figure 4K qPCR gene expression: T cell/monocyte co-culture with HC, SLE-NP and SLE-P serum

CD206	SLE-NP	SLE-P
	1.453972	1.68179
	1.385109	1.89212
	0.779165	0.8932
	0.742262	0.96264
Mean	1.09	1.357
SEM	0.1909	0.2521

STAT-1	SLE-NP	SLE-P
	4.773343	2.10672
	3.877159	1.93858
	0.9	0.7
	0.98	0.6
Mean	1.16	0.9
SEM	0.8246	0.3206

Figure 4M qPCR data for Thp-1 co-culture

CD206	HC	SLE-NP	SLE-P
	0.619	0.426	1.15
	0.681	0.41	0.819
	0.973	0.625	0.72
Mean	0.7577	0.487	0.8963
SEM	0.1091	0.06915	0.13

CD200R	HC	SLE-NP	SLE-P
	1.992058	2.05411	4.242907
	2.77404	2.40509	1.290429
	1.689537	1.41191	3.503563
Mean	2.152	1.957	3.012
SEM	0.3231	0.2908	0.887
PPBP	HC	SLE-NP	SLE-P
	7.213766	7.59742	5.78096
	3.12593	4.76303	9.311646
	6.946827	10.5163	7.482185
Mean	5.762	7.626	7.525
SEM	1.32	1.661	1.019
CD80	HC	SLE-NP	SLE-P
	0.479	0.937	0.858
	0.585	0.552	1.71
	1.08	1.27	1.405
Mean	0.7147	0.9197	1.324
SEM	0.1852	0.2074	0.2492
STAT1	HC	SLE-NP	SLE-P
	1.08	0.9	0.7
	1.15	0.88	0.64
	0.97	1.06	0.83
Mean	1.067	0.9467	0.7233
SEM	0.05239	0.05696	0.05608
Figure 4N	Blocking IL-4 antibody experiment		

STAT-1	isotype	anti-IL4 blocking antibody
HC	1	1.23971
	0.959264	0.92019
	0.358489	1.29235
HC	1	1.33869
	1.385109	1.66864
	0.716978	0.97266
mean	0.9033	1.239
SEM	0.1397	0.111
CD80		
	isotype	anti-IL4 blocking antibody
	1	1.49485
	0.817902	1.01396
	0.386891	0.97942
	1	0.90125
	1.197479	1.49485
	0.550953	0.73714
mean	0.8255	1.104
SEM	0.1248	0.1297
CD206		
	isotype	anti-IL4 blocking antibody
	1	1.12506
	1	0.84675
	1.536875	1.29235
	1.197479	0.80107
	0.277392	0.34628
	1.443929	1.19748
mean	1.076	0.9348
SEM	0.1837	0.142

Figure 5B	iNKT cell frequencies %				absolute number				iNKT cell CD69+			
	SLENP	SLE-P (1-2)	SLE-P (>3)	SLE-CVD	SLENP	SLE-P (1-2)	SLE-P (>3)	SLE-CVD	SLENP	SLE-P (1-2)	SLE-P (>3)	SLE-CVD
		0.012	0.025	0.011	5.64	23.64	42.5	14.4	0	30.5	25.9	
	0.0077	0.08	0.0039	0.03	46.76	156	8.697	70.4	29.3	64.3	28.2	23
	0.0175	0.19	0.025	0.023	27.28	184.3	11	4.9059	6.3	44.2	1.43	10.4
	0.028	0.011	0.0053	0.042	26.29	7.049	22.1778		6.52	4.63	7.29	5.41
	0.031	0.052	0.026	0.00328	22.36	64.5	63		36.5	57.7	5.1	6.39
	0.023	0.057	0.013	0.025	14.64	16.51	34		5.17	3.51	10.8	14.6
	0.0135	0.041	0.13	0.96	37.8	52.89	87.4		3.05	25	2.86	13
	0.048	0.025	0.068	0.22	41.63	61	17.04			43.6	24.8	22.6
	0.019	0.14	0.012	0.00711	41.63	277.2	207.4		91.4	18.1		18.4
	0.01	0.085	0.00999		67.62	16.4	7.8			13	39.5	
	0.05	0.028			51.1	77.5	11.2		17.2	16.9		
	0.018	0.015			19.08	9.36			24.3			
	0.038	0.0056			14.52	63.46			17.7			
	0.087	0.024			18.673	125.28			91.4	43.7		
	0.023	0.0062			34.71	39.84			0.81			
	0.016				34.08	10.106			3.53	83.4		
	0.21				273				92.4			
	0.066				47.97				24.5			
	0.044				20.88				58.8			
	0.042				3.969				16.1			
	0.018				52.8				15			
	0.0084				49.92				7.14			
	0.011				150.245				81.1			
	0.00822				121.41				11.8			
	0.0545				7.59				18.2			
	0.0165				15.18				1.03			
	0.033				27.36				0.44			

0.025	14.56	5.32
0.0215	22.05	5.56
0.01255	13.26	17.6
0.027	85.2	1.36
0.0395		80.8
0.064		38.4
0.0995		27.9
0.057		22.7
0.017		15.4
0.0135		7.56
0.018		9.55
0.01146		39.7
0.0655		14.4
0.012		75.4

Figure 5C	CD8+ iNKT cells				DN iNKT cells			
	SLE-NP	SLE-P1-2	SLE-P3-4	SLE-CV	SLE-NP	SLE-P1-2	SLE-P3-4	SLE-CV
	7.04	25.7	2.74	34.6		66.8		
	1.39	17.2	12.5	54	61.1	40.7	53.4	9.71
	8.31	44	13.3	38	79.1	26.7	17	5.13
	4.17	6.11	21	77.3	50	11.5	8	3.93
	10	8.04	11.8	59.3	45	46.4	23.5	2.98
	2.22	22.7	11.2		46.7	52.3	11.9	
	2.17	16.9	7.14		21.7	40	2.38	
	11.4		2.86		47.8	59.3	14.3	
	10	38.5	2.86		31.7	13.8	45.7	
	1.01		6		70.7	25.5	81.1	
	11				56.2			
	8.16				24.5			

21.4

37.5

21.2

3.2

8.39

9.94

iNKT cell IL-4+

iNKT cell IFNg

SLENP	SLE-P (1-2)	SLE-P (>3)	SLE-CVD	SLENP	SLE-P (1-2)	SLE-P (>3)	SLE-CVD
34.9	81.5	77.4	42.4	15			21.8
46.5	42.6		10	66.7	90.1	6.67	19.7
31.1	12.2		18.9	34.3	8.76	14.6	23.5
43.2	68.9	47.3	32.1	13.6	55.1	86.3	19.8
83.3	43.7	2.7	34.7	28.6	37.4	18.8	8.11
4.91	46.7			25.6	23.6	22.1	27.8
50	49.1	98.1		41.4	44.4	63	5
53.2	76.7	65		40.7	15	52.1	2.7
15.5	81.8	49.7		82.3	54.2	38.9	28.3
70.9		38.5		25.2		25	24.5
28.1	34.3			16.1	8.76	86.4	
40	21			2.13	6.52	43.1	
87.1	50				4.8	38	
54.2				25.3	26.1	34.3	
39.2	43.2						
78.9	57.1			13.2			
71.1	81.2			50.8			
35.2				90.1			
15.6							
54				45.3			
8.96				47.6			

76.9	56.2
43.9	
18.7	61.5
27.1	71.3
52.2	2.21
18.5	1.09
38.3	60
53.3	78.9
67.6	80.8
38.6	21.7
12.3	29.1
	31.2
	42.5
	26.4
	51.9
	52.6
	27.1
	58.1
	59
	23.8
	31.2
	48.1
	39.5
	83.3
	19.5
	82
	84.8
	17.5
	81.3

Supplementary data

Figure S2B	CD8+CD4-			DP			CD8-CD4+			DN		
	HC	SLE-NP	SLE-P	HC	SLE-NP	SLE-P	Healthy	SLE-NP	SLE-P	Healthy	SLE-NP	SLE-P
	2.98	7.04	2.74	2.01	38	3.42	34.4	45.1	13	60.7	9.86	46.4
	14	1.39	8.04	32.6	6.94	28.6	48.8	30.6	17	64.65	61.1	53.4
	4.17	8.31	12.5	0.83	1.43	24.4	15.8	11.2	24.1	79.2	79.1	66.8
	2.74	4.17	25.7	0.78	25	17.9	3.13	20.8	54.5	93.3	50	40.7
	9.44	10	17.2	21.5	5	22.4	17.8	40	57	51.3	45	11.9
	20.7	2.22	11.2	15	20	12.6	41.8	31.1	15.9	22.5	46.7	17
	13.2	2.17	13.3	1.52	21.7	2.27	12.1	54.3	23.1	73.1	21.7	52.3
	35.7	11.4	22.7	0.28	9.17	13.8	9.91	31.7	14.7	53.5	47.8	40
	8.38	10	16.9	31.1	6.67	12.9	31.1	51.7	21.4	29.3	31.7	26.7
	5.56	1.01	44	5.56	4.04	69	36.1	24.2	56	52.8	70.7	2.38
	12.6	11	7.14	1.87	16.4	15	13.2	16.4	57.1	72.3	56.2	8
	2.83	8.16	21	1.31	32.7	25.7	12.9	34.7	52.9	82.9	24.5	14.3
	4.76	21.4	2.86	3.64	21.4	11.8	19.1	21.4	28.8	52.7	35.7	23.5
		37.5	11.8		22.5	11.9		5	38.1		35	59.3
		21.2	38.5		9.62	9.62		48.1	22.9		21.2	13.8
		3.2	2.86		8.8	28.6		16.8	49.6		71.2	45.7
		8.39	6.11		8.11	32.8		25.9	70.2		50	11.5
		9.94	6		6.45	28.4		25.3	60		52.1	81.1
			26.9			32.9			54.8			25.5
Mean	10.5431	9.91667	15.6553	9.07692	14.6628	21.2637	22.78	29.6833	38.4789	60.6346	44.9756	33.6989

Figure S5A	monocyte CD36%			Monocyte LDLR			Monocyte LOX-1			Monocyte LRP-1		
	HC	SLENP	SLEP	HC	SLENP	SLEP	HC	SLENP	SLEP	HC	SLE-NP	SLE-P
	98.6	96.9	90.9	0.41	1.03	0.41	1.93	0.28	0.4	95.95	97.75	95.66
	95.1	98.6	59.5	2.61	0.6	0.95	1.68	0.47	0.77	99.63	87.58	96.79
	96.3	95.6	98.6	1.32	1.2	1.62	0.94	7.33	3.3	99.55	96.06	96.44

97.98	98.4	72.7	0.47	1.71	1.41	0.69	1.23	1.65	99.45	98.32	98.11	
99.84	98.7	85.9	0.27	4.83	0.45	1.93	2.15	0.78	99.42	99.39		
99.68	99.13	98.22	0.28	0.9	0.43	1.64	0.9	1.27	87.49	95.23		
99.61	90.85	99.7	0.3	0.13	0.27	1.89	0.94	1.6	97.24	96.02		
99.86	98.87	99.25	0.19	0.21	0.04	1.51	1.03	1.16		98.69		
98.07	96.85	98.29	0.17	0.16	0.64	3.66	1.75	3.35				
98.43	93.82		0.35	0.07		3.13	11.9					
	99.24			0.72			5.79					
	96.23			0.64			3.13					
	99.22			0.28								
Mean	98.347	97.1085	89.2289	0.637	0.96	0.69111	1.9	3.075	1.58667	96.9614	96.13	96.75

Figure S5B Monocyte CD1d

	Healthy	SLE-NP	SLE-P
	3389	1545	4031
	5119	2816	3526
	902	885	1679
	967	3133	945
	4500	3406	645
	4735	1043	2416
	1939	1240	832
	1621	4943	4140
	3506	2304	1110
	3481	2291	5660
	2308	4531	1853
	4029	5435	3581
	1256	2669	1121
	772	4291	2723
		1262	1169
		1777	3464

4641	1959
748	1240
1762	6094
2006	1099
1981	4627
1988	2198
4668	1186
2569	895
1248	
2563	
1781	
1062	
1415	
825	
2978	
1251	
721	

Figure S6	iNKT cells vs GSM			iNKT+ IL-4+ cells vs GSM			iNKT cells vs TPA			iNKT+ IL-4+ cells vs TPA			iNKT cells vs Plaque thickness		
	GSM	1-2 sites	3-4 sites	GSM	1-2 sites	3-4 sites	TPA	1-2 sites	3-4 sites	TPA	1-2 sites	3-4 sites	Plaque thickness	1-2 sites	3-4 sites
	64	23.64		64	81.5		18.12	23.64		18.12	81.5		0.2	23.64	
	22	156		70	43.2		6.89	156		36.21	43.2		0.14	156	
	70	184.3		21	83.3		36.21	184.3		38.74	83.3		0.28	184.3	
	21	26.29		35	46.7		38.74	26.29		57.89	46.7		0.4	26.29	
	38.5	52.89		43	49.1		24.54	52.89		106.92	49.1		0.23	52.89	
	71	61		38.5	76.7		27.54	61		24.54	76.7		0.25	61	
	128	277.2		71	81.8		37.61	277.2		27.54	81.8		0.3	277.2	
	32.5	16.4		128	4.3		26.9	16.4		37.61	4.3		0.35	16.4	
	48.5	77.5		32.5	28.1		111.68	77.5		26.9	28.1		0.68	77.5	
	80.5	9.36		48.5	40		85.12	9.36		111.68	40		0.86	9.36	

43.5	63.46		80.5	87.1	83.69	63.46	85.12	87.1	0.85	63.46	
68.5	125.28		43.5	54.2	7.77	125.28	83.69	54.2	0.31	125.28	
27.5	39.84		68.5	81.2	36.39	39.84	7.77	81.2	0.42	39.84	
56.5	34.08		27.5	43.2	62.57	34.08	36.39	43.2	0.58	34.08	
30.5	273		56.5	5.8	8.88	10.106	62.57	5.8	0.65	273	
22	10.106		22	57.1	148.67		42.5	8.88	57.1	0.15	10.106
59		42.5	59		46.5	138.48	8.697	148.67	46.5	1.12	42.5
34		8.697	34		31.1	64.3	11	138.48	31.1	1.1	8.697
59		11	59		68.9	89.05	7.049	64.3	68.9	0.9	11
37		7.049	37		43.7	197	22.36	89.05	43.7	0.71	7.049
45.67		22.36	57.5		21	69.38	16.51	66.69	21	0.81	22.36
42.67		16.51	42.75		50	66.69	192.4	105.72	50	0.63	16.51
57.5		192.4	45.5		65	95.1	34	120.08	65	0.84	192.4
62.5		34	38.25		49.7	105.72	87.4	186.48	49.7	0.9	34
42.75		87.4	44.25		38.5	120.08	17.04	99.16	38.5	1.18	87.4
45.5		17.04	58.25		34.3	186.48	207.4	102.78	34.3	1.07	17.04
38.25		207.4				317.93		7.8			
76.88		7.8				102.78		11.2			
58.25		11.2									

Figure S7E

	HC	SLE-NP	SLE-P 1-2	SLE-P 3-4	SLE-CV
	0.31	0.029	1.14	0.038	0.00478
	0.46	0.038	0.047	0.022	0.02
	0.42	0.029	0.17	0.14	0.013
	0.13	0.026	3.88	0.052	0.0078
		0.00719	0.096		0.00374
		0.011			
mean	0.33	0.02337	1.0666	0.063	0.00986

