

Generalised phase kick-back: the structure of computational algorithms from physical principles

This content has been downloaded from IOPscience. Please scroll down to see the full text.

2016 New J. Phys. 18 033023

(<http://iopscience.iop.org/1367-2630/18/3/033023>)

View [the table of contents for this issue](#), or go to the [journal homepage](#) for more

Download details:

IP Address: 128.41.61.18

This content was downloaded on 17/01/2017 at 11:15

Please note that [terms and conditions apply](#).

You may also be interested in:

[Discrete Quantum Mechanics: Entanglement](#)

H T Williams

[Deriving Grover's lower bound from simple physical principles](#)

Ciarán M Lee and John H Selby

[Computation in generalised probabilistic theories](#)

Ciarán M Lee and Jonathan Barrett

[Entanglement and thermodynamics in general probabilistic theories](#)

Giulio Chiribella and Carlo Maria Scandolo

[Higher-order interference and single-system postulates characterizing quantum theory](#)

Howard Barnum, Markus P Müller and Cozmin Ududec

[Density cubes and higher-order interference theories](#)

B Daki

, T Paterek and Brukner

[A framework for phase and interference in generalized probabilistic theories](#)

Andrew J P Garner, Oscar C O Dahlsten, Yoshifumi Nakata et al.

[Theory-independent limits on correlations from generalized Bayesian networks](#)

Joe Henson, Raymond Lal and Matthew F Pusey

[Interference of identical particles from entanglement to boson-sampling](#)

Malte C Tichy



PAPER

Generalised phase kick-back: the structure of computational algorithms from physical principles

OPEN ACCESS

RECEIVED

2 December 2015

REVISED

5 February 2016

ACCEPTED FOR PUBLICATION

22 February 2016

PUBLISHED

11 March 2016

Original content from this work may be used under the terms of the [Creative Commons Attribution 3.0 licence](#).

Any further distribution of this work must maintain attribution to the author(s) and the title of the work, journal citation and DOI.

Ciarán M Lee^{1,3} and John H Selby^{1,2,3}¹ University of Oxford, Department of Computer Science, Wolfson Building, Parks Road, Oxford OX1 3QD, UK² Imperial College London, London SW7 2AZ, UK³ These authors contributed equally to this work.E-mail: ciaran.lee@cs.ox.ac.uk and john.selby08@imperial.ac.uk**Keywords:** quantum computation, generalised probabilistic theories, quantum algorithms, higher-order interference**Abstract**

The advent of quantum computing has challenged classical conceptions of which problems are efficiently solvable in our physical world. This motivates the general study of how physical principles bound computational power. In this paper we show that some of the essential machinery of quantum computation—namely reversible controlled transformations and the phase kick-back mechanism—exist in any operational-defined theory with a consistent notion of information. These results provide the tools for an exploration of the physics underpinning the structure of computational algorithms. We investigate the relationship between interference behaviour and computational power, demonstrating that non-trivial interference behaviour is a general resource for post-classical computation. In proving the above, we connect higher-order interference to the existence of post-quantum particle types, potentially providing a novel experimental test for higher-order interference. Finally, we conjecture that theories with post-quantum interference—the higher-order interference of Sorkin—can solve problems intractable even on a quantum computer.

1. Introduction

One of the major conceptual breakthroughs in physics over the past 30 years was the realisation that quantum theory offers dramatic advantages [4] for various information-processing tasks—computation in particular [1, 2, 4]. This raises the general question of how physical principles bound computational power. Moreover, what broad relationships exist between such principles and computation? A major roadblock to such an investigation is that quantum computation is phrased in the language of Hilbert spaces, which lacks direct physical or operational significance.

In contrast, the framework of operationally defined theories [5–9] provides a clear-cut operational language in which to investigate this problem. Theories within this framework can differ [7] from classical and quantum theories. While many of them may not correspond to descriptions of our physical world, they make good operational sense and allow one to assess how computational power depends on the physical principles underlying them in a systematic manner.

Previous investigations into computation within this framework have taken a high-level approach using the language of complexity classes to derive general bounds on the power of computation [9]. However, much of quantum computing is concerned not so much with this high-level view, but instead with the construction of concrete algorithms to solve specific problems. A deeper understanding of the general structure of computational algorithms in this framework has so far remained illusive. Here we take this low-level algorithmic view and ask which physical principles are required to allow for some of the common machinery of quantum computation in this context.

In this paper we show that three physical principles, *causality* (which roughly states that information propagates from present to future), *purification* (roughly, that information is fundamentally conserved) and *strong symmetry* (all information carriers of the same size are equivalent)—which are necessary for a well defined

notion of information—are sufficient for the existence of reversible controlled transformations (theorem (2), section 3) and a generalised *phase kick-back mechanism* (theorem (3), section 3). In the quantum case, the phase kick-back mechanism [3] plays a vital role in almost all algorithms—notably the Deutsch–Jozsa algorithm, Grover’s search algorithm and Simon’s algorithm—while reversible controlled transformations are central components of most well-studied universal gate sets and fundamental for the definition of computational oracles.

One might ask how the computational power of theories with these crucial algorithmic components depends on their underlying physical properties. One such property—currently under both theoretical [11–14] and experimental [15, 16] investigation—is the existence of *higher-order interference*.

Sorkin [17, 18] has introduced a hierarchy of mathematically conceivable *higher-order* interference behaviours and shown that quantum theory is limited to having only second-order interference. Informally, this means that the interference pattern created in a three-or more-slit experiment can be written in terms of the two and one slit interference patterns obtained by blocking some of the slits; no genuinely new features result from considering three slits instead of two. This is in contrast to the existence of second-order interference where the two slit interference cannot be reproduced from that of single slits. Informally, theories are said to have higher-order interference if irreducible interference patterns can be created in multi-slit experiments.

Second-order interference between quantum computational paths appears to be a resource for non-classical computation [4, 19]. It therefore seems prudent to investigate how different interference behaviour is related to computation in general. In quantum theory there is an intimate connection between phase transformations—such as those used in the kick-back mechanism—and interference. Motivated by this, in section (2.2.2), we introduce a framework that relates higher-order interference to *phase transformations* in operationally defined theories.

We show that the generalised phase kick-back mechanism allows one to access any ‘higher-order phase’ in a controlled manner. Using this, in section (3.2), we show that the existence of non-trivial interference behaviour allows for the solution of problems intractable on a classical computer. We also conjecture that these higher-order phase kick-backs allow for the solution of computational problems intractable even on a *quantum* computer. Additionally, in section (3.1), we show that higher-order phases lead to new particle types that exhibit both qualitatively and quantitatively different behaviour to fermions, bosons and anyons. Thus potentially providing a new experimental test of higher-order interference.

2. The framework

2.1. Operational physical theories

We work in the circuit framework for operationally defined theories developed in [5, 6, 8]. An operational theory specifies a set of physical processes that can be connected together to form experiments and assigns probabilities to different experimental outcomes. A process has input ports, output ports, and a classical pointer. When a process is used in an experiment, the pointer comes to rest in one of a number of positions, indicating an outcome has occurred. Intuitively, one can think of *physical systems* as passing between the ports of these processes. These systems come in different types, denoted $A, B \dots$. In an experiment these processes can be composed both sequentially and in parallel, and when composed sequentially, types must match.

In this framework, closed circuits define probabilities. Processes that yield the same probabilities in all closed circuits are identified. The set of equivalence classes of processes with no input ports are called *states*, no output ports *effects* and both input and output ports *transformations*. The set of all states of system A is denoted Ω_A , the set of all effects on B is denoted \mathcal{E}_B and the set of *reversible* transformations between systems A and B is denoted \mathcal{R}_A^B ⁴. Note that \mathcal{R}_B^A has a group structure. A state is *pure* if it does not arise as a *coarse-graining* of other states⁵; a pure state is one for which we have maximal information. A state is *mixed* if it is not pure. Similarly, one says a transformation is pure if it does not arise as a coarse-graining of other transformations. It can be shown that reversible transformations are pure.

The ‘Dirac-like’ notation ${}_A|s\rangle$ is used to represent a state of system A , and $\langle e_r|_B$ to represent an effect on B . Here r is the position of the classical pointer, which can be thought of as the outcome of the measurement defined by $\{\langle e_r|\}_r$. States, effects and transformations can be represented diagrammatically:

⁴ The set of states, effects and transformations each give rise to a vector space and transformations and effects act linearly on the vector space of states. We assume in this work that all vector spaces are finite dimensional.

⁵ The process $\{\mathcal{U}_j\}_{j \in Y}$, where j index the positions of the classical pointer, is a coarse-graining of the process $\{\mathcal{E}_i\}_{i \in X}$ if there is a disjoint partition $\{X_j\}_{j \in Y}$ of X such that $\mathcal{U}_j = \sum_{i \in X_j} \mathcal{E}_i$.

$$\langle s | \text{---} A \text{---} T \text{---} B \text{---} | e_r \rangle = (e_r | {}_B T_A | s)$$

This diagrammatic approach was inspired by the categorical formalism of quantum mechanics [30, 31].

Definition 1 (Causality [5]). A theory is said to be *causal* if there exists a unique deterministic effect $(\mathbb{1}|$ for every system, such that $\sum_r (e_r | = (\mathbb{1}|$ for all measurements, $\{(e_r |)_r\}$.

Mathematically, causality is equivalent to the statement: ‘Probabilities of present experiments are independent of future measurement choices’. In causal theories, all states are *normalised* [5]. That is, $(\mathbb{1}|s) = 1$ for all $|s)$. The deterministic effect allows one to define a notion of *marginalisation* for multi-partite states.

Definition 2 (Purification [5]). Given a state ${}_A |s)$ there exists a system B and a pure state ${}_{AB} |\psi)$ on AB such that ${}_A |s)$ is the marginalisation of ${}_{AB} |\psi)$:

$$\langle \psi | \text{---} A \text{---} B \text{---} | \mathbb{1} \rangle = \langle s | \text{---} A$$

Moreover, the purification ${}_{AB} |\psi)$ is unique up to reversible transformations⁶ on the purifying system, B .

While the purification principle appears to only concern states, it can be leveraged to prove somewhat analogous results about transformations ([5], theorem 15): let T, T' be reversible transformations. If

$$\langle s | \text{---} T \text{---} | \mathbb{1} \rangle = \langle s' | \text{---} T' \text{---} | \mathbb{1} \rangle,$$

then there exists a reversible transformation G such that

$$\langle \sigma | \text{---} T \text{---} | \mathbb{1} \rangle = \langle \sigma | \text{---} T' \text{---} G \text{---} | \mathbb{1} \rangle \quad \forall |\sigma)$$
(1)

Equation (1), above, depicts the equivalence of purifications of a transformation up to a local reversible transformation, as opposed to the purification of states mentioned in definition (2). These can in fact been shown to be equivalent [5, 6], and so we will use the term *purification* when referring to either notion.

Pure states $\{|s_i)\}_{i=1}^n$ are *perfectly distinguishable* if there exists a measurement, corresponding to effects $\{(e_j |)_{j=1}^n$, such that $(e_j |s_i) = \delta_{ij}$ for all i, j . Note that an n -tuple of pure and perfectly distinguishable states can reliably encode an n -level classical system.

Definition 3 (Strong symmetry [11]). A theory satisfies *strong symmetry* if for any two n -tuples of pure and perfectly distinguishable states $\{|\rho_i)\}, \{|\sigma_i)\}$, there exists a reversible transformation T such that $T|\rho_i) = |\sigma_i)$ for $i = 1, \dots, n$.

Informally, the purification principle says that information is fundamentally conserved, strong symmetry states that all information carriers of the same size are equivalent and causality implies that information propagates from present to future. Note that standard quantum theory, real vector space quantum theory and the classical theory of pure states satisfy all of the above principles. These principles will be shown to be a primer for interesting and consistent computation. In section (3.2), we shall investigate the change in computational power as one varies the interference behaviour in theories satisfying causality, purification and strong symmetry.

2.2. Higher-order interference via phase transformations

2.2.1. A quantum example

Perhaps the cleanest example of interference in quantum theory is exhibited by the Mach–Zehnder interferometer, illustrated below:

⁶ That is if two states $|\psi\rangle_{AB}$ and $|\psi'\rangle_{AB}$ purify $|s\rangle_A$, then there exists a reversible transformation T_B on system B such that $|\psi\rangle_{AB} = (\mathbb{1} \otimes T_B)|\psi'\rangle_{AB}$.

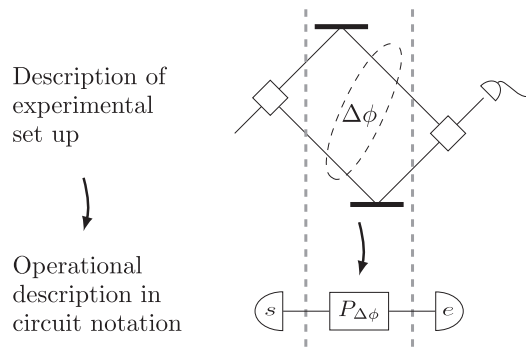

There are three parts to this:

(1) Prepare a state as a superposition of paths:

$$|s\rangle = |+\rangle\langle +| := \rho_+$$

(2) Apply a ‘phase transformation’:

$$P_{\Delta\phi}|s\rangle = R_z^{\Delta\phi} \rho_+ R_z^{\Delta\phi\dagger},$$

with $R_z^{\Delta\phi}$ a rotation by $\Delta\phi$ about the z-axis of the Bloch ball.

(3) Measure in a superposition of paths:

$$\langle e|P_{\Delta\phi}|s\rangle = \text{Tr}(\rho_+ R_z^{\Delta\phi} \rho_+ R_z^{\Delta\phi\dagger}) = \cos^2\left(\frac{\Delta\phi}{2}\right).$$

The observed interference pattern is therefore a map from the group of ‘phase transformations’, parametrised by $\Delta\phi$, to the unit interval (i.e. probabilities),

$$P_{\Delta\phi} \mapsto \cos^2\left(\frac{\Delta\phi}{2}\right). \quad (2)$$

The existence of interference in quantum theory is encapsulated in the statement: “the interference pattern observed for a particular superposition measurement cannot be reproduced by the statistics generated by ‘which path’ measurements”. In the above example this translates to:

$$\cos^2\left(\frac{\Delta\phi}{2}\right) \neq \sum_{i=0}^1 q_i \text{Tr}(|i\rangle\langle i| R_z^{\Delta\phi} \rho_+ R_z^{\Delta\phi\dagger}), \quad (3)$$

where q_i is an arbitrary constant. Equation (3) is to be interpreted as an inequality of the functions defined on the right- and left-hand side. That is, these functions do not coincide on all phase transformations. This follows from the fact that:

$$R_z^{\Delta\phi\dagger} |i\rangle\langle i| R_z^{\Delta\phi} = |i\rangle\langle i|, \quad \forall i \in \{0, 1\}. \quad (4)$$

That is, the left-hand side of equation (3) depends on $\Delta\phi$ while the right-hand side does not.

2.2.2. Operational theories

The quantum example from section (2.2.1) illustrates the key components necessary to discuss interference:

- (i) a notion of ‘path’,
- (ii) a notion of ‘superposition of paths’,
- (iii) transformations that leave the statistics of ‘which path’ measurements invariant, i.e. ‘phase transformations’,
- (iv) a notion of ‘interference pattern’, i.e. a way of associating phase transformations with probabilities.

These points will now be discussed in the context of arbitrary operationally defined theories. We then use this framework to link higher-order interference and phase transformations. Our approach is similar in spirit to that of Garner *et al* [20], with the caveat that they have not considered higher-order interference.

(i) *Paths*: a path is defined by a state and effect pair, where we view the state as ‘preparing a state which belongs to the path’ and the effect as ‘measuring whether the state belongs to the path’ and so we demand the probability of the state-effect pair to be one.

Definition 4. *Paths, p :*

$$p := (|s\rangle, |e\rangle \text{ s.t. } \langle e|s\rangle = 1.$$

In our quantum example, the paths were $p_0 = (|0\rangle\langle 0|, |0\rangle\langle 0|)$ and $p_1 = (|1\rangle\langle 1|, |1\rangle\langle 1|)$.

Paths are disjoint if the state defining one path has zero probability of belonging to the other, and vice versa.

Definition 5. *Disjoint paths, $p_1 \perp p_2$:*

$$p_1 \perp p_2 \iff \langle e_i|s_j\rangle = \delta_{ij}.$$

An n -path experiment is defined by n mutually disjoint paths such that the set consisting of the effects from each path forms a measurement.

Definition 6. *n -path experiment, \mathbb{P} :*

$$\mathbb{P} := \{p_i\} \text{ s.t. } p_i \perp p_j \ \forall i \neq j, \text{ and } \sum_i \langle e_i| = \langle \mathbb{1}|.$$

In the quantum case, an n -path experiment would correspond to a multi-arm interferometer.

(ii) *Superposition of paths:* a superposition of paths will be defined relative to some n -path experiment \mathbb{P} via the notion of *support*. We say that a state (or effect) has support on a path if the effect (or state) associated to that path gives a non-zero probability.

Definition 7. *Support of a state or effect, $\text{Supp}[|s\rangle]$ or $\text{Supp}[|e\rangle]$:*

$$\begin{aligned} \text{Supp}[|s\rangle] &:= \{p_i \in \mathbb{P} \mid \langle e_i|s\rangle \neq 0\}, \\ \text{Supp}[|e\rangle] &:= \{p_i \in \mathbb{P} \mid \langle e|s_i\rangle \neq 0\}. \end{aligned}$$

If the support of a state consists of more than one path this does not guarantee that it is a superposition of paths—it could equally well be a classical mixture of paths. A superposition state must therefore lie outside the convex hull of the states which have support only on a single path. In our quantum example, the state $|+\rangle\langle +|$ —introduced in point (1) of section (2.2.1)—was a superposition of paths.

We can define set of states (or effects) with support on some subset of paths $I \subseteq \mathbb{P}$ as:

$$\begin{aligned} \Omega_I &:= \{|s\rangle \in \Omega \mid \text{Supp}[|s\rangle] = I\}, \\ \mathcal{E}_I &:= \{|e\rangle \in \mathcal{E} \mid \text{Supp}[|e\rangle] = I\}. \end{aligned}$$

(iii) *Phase transformations:* a phase transformation—relative to some \mathbb{P} —is any transformation that leaves the statistics of ‘which path’ measurements invariant.

Definition 8. *Phase group, \mathcal{P} :*

$$\mathcal{P} := \{T \in \mathcal{R} \mid \langle e_i|T = \langle e_i, \forall i \in \mathbb{P}\}.$$

In the quantum example, the phase transformation was the rotation $R_z^{\Delta\phi}$ introduced in point (2) of section (2.2.1).

(iv) *Interference patterns:* we now generalise the quantum interference pattern of equation (2) to arbitrary operational theories.

Definition 9. *Interference pattern, $\mathcal{C}_{s,e}$:*

$$\mathcal{C}_{s,e} : \mathcal{P} \rightarrow [0, 1] :: T \mapsto \langle e|T|s\rangle$$

Given this definition, equation (3) translates into the existence of $|e\rangle \in \mathcal{E}_{\{0,1\}}$ —that is, an effect with support on path 0 and path 1—and $|s\rangle \in \Omega_{\{0,1\}}$ such that

$$\mathcal{C}_{s,e} \neq \sum_{i=0}^1 \mathcal{C}_{s,e_i} \quad (5)$$

for all possible choices of $|e_i\rangle \in \mathcal{E}_{\{i\}}$ including subnormalised effects, this is the analogue of the q_i ’s in equation (3). In other words, there is some choice of superposition state and effect such that their interference pattern cannot be reproduced by the statistics generated by effects with support on a single path.

Other approaches to defining higher-order interference in operational theories (for example [11]) have additional structure such that one can define a set of ‘filters’, $\{F_I\}$, for the theory. These are transformations that represent the action of leaving open some subset of paths I while blocking the others. In this case one can define $(e_I) = (e|F_I$ giving a specific set of effects. However, arbitrary theories do not have sufficient structure to define filters and so one must consider all possible choices $(e_I|$ with the correct support. Otherwise [25, 26] one can—even in quantum and classical theory—choose a specific set of $(e_I|$ to give the artificial appearance of higher-order interference.

It follows that the existence of a non-trivial phase group implies the existence of interference in a general theory. Indeed, the left-hand side of equation (5) depends on the phase group element, while the right-hand side does not—the analogue of equation (4) from the quantum example. We now use our framework to discuss higher-order interference.

2.2.3. Higher-order interference and phase

Adapting Sorkin’s original definition of higher-order interference [17] to our framework results in: the existence of n th-order interference in an n -path experiment corresponds to the existence of an effect $|e\rangle$ and a state $\langle s|$ such that

$$C_{s,e} \neq \sum_{I \subset \mathbb{P}} (-1)^{n-|I|+1} C_{s,e_I}, \tag{6}$$

for all $|e_I\rangle \in \mathcal{E}_I$. As in equations (3) and (6) is to be interpreted as an inequality of the functions defined on the right and left. See appendix D for an in-depth discussion of equation (6).

Motivated by equation (6), we wish to determine if particular phase transformations give rise to higher-order interference. The defining feature of phase transformations is that they leave the statistics of effects with support on single paths—that is, effects in $\bigcup_i \mathcal{E}_{\{i\}}$ —invariant. The natural generalisation of this is to consider transformations that not only leave the statistics of effects on single paths invariant, but also superposition effects. This motivates the following definition.

Definition 10. A transformation T is n -undetectable

if: $\langle e|T = \langle e|, \forall \langle e| \in \bigcup_{I:|I|\leq n} \mathcal{E}_I$.

Together with its natural converse.

Definition 11. A transformation T is m -detectable

if there exists $\langle e| \in \bigcup_{I:|I|\leq m} \mathcal{E}_I$, such that $\langle e|T \neq \langle e|$.

We can now link higher-order interference to certain types of phase transformations, which we call higher-order phases.

Theorem 1. A transformation T that is n detectable and $n - 1$ undetectable implies the existence of n th-order interference.

Proof. Choose $\langle s|$ and $\langle e|$ such that T is detected. It is then clear that the left-hand side of equation (6) is dependent on T , while—due to undetectability—the right-hand side is not. They are thus distinct functions. \square

In our quantum example, the phase transformation was two-detectable, but one-undetectable.

3. Controlled transformations and a generalised phase kick-back

Definition 12. Given a set of pure and perfectly distinguishable states $\{|i\rangle\}$ and a set of transformations $\{T_i\}$, we define a controlled transformation $C\{T_i\}$ as:

$$\begin{array}{c} \text{---} i \text{---} \\ \text{---} \sigma \text{---} \end{array} \boxed{C \{T_i\}} \text{---} = \begin{array}{c} \text{---} i \text{---} \\ \text{---} \sigma \text{---} \end{array} \boxed{T_i} \text{---} \quad \forall i, |\sigma\rangle \tag{7}$$

The top system and lower systems are referred to as the control and target respectively.

Note that classical controlled transformations—where the control is measured and conditioned on the outcome a transformation is applied to the target—exist in any causal theory [5] with sufficient distinguishable states. However, such transformations are in general not reversible and do not offer an advantage over classical

phases arise via the generalised mechanism. Consider the set of pure and perfectly distinguishable states $\{|s_i\rangle\}$ and let $\{T_i\}$ be elements of their phase group, i.e. $T_i|s_j\rangle = |s_j\rangle, \forall i, j$. Construct the controlled transformation $C\{\{T_i\}\}$. The designation of control and target for $C\{\{T_i\}\}$ is symmetric:

$$\begin{array}{c} \sigma \\ \hline \text{---} \\ \hline C \\ \hline s_i \\ \hline \text{---} \\ \hline \{T_i\} \end{array} = \begin{array}{c} \sigma \\ \hline \text{---} \\ \hline Q_i \\ \hline s_i \\ \hline \text{---} \\ \hline \end{array} := \begin{array}{c} \sigma \\ \hline \text{---} \\ \hline \{Q_i\} \\ \hline s_i \\ \hline \text{---} \\ \hline C \end{array} \quad \forall |\sigma\rangle$$

Thus any $C\{\{T_i\}\}$ is control-target symmetric if the T_i are elements of a phase group. The transformations on the target are given by the kicked-back phases, $\{Q_i\}$. Given an arbitrary W_i , construct the transformation $\{W_i\}C$ and note that via control-target symmetry it is equivalent to $C\{G_i\}$, for some $\{G_i\}$. The controlled transformation $C\{G_i\}$ thus gives rise to the kicked-back phase W_i and we have:

Theorem 3. *Every phase transformation can arise via a generalised phase kick-back mechanism.*

3.1. Particle exchange experiments

Dahlsten *et al* [23] have shown that there is a close connection between particle exchange statistics and the phase group in operational theories. We use the framework and results presented in this paper to expand upon and formalise these connections. Motivated by the quantum case, place a pair of indistinguishable particles in superposition by inputting them to an interferometer, as shown in the following diagram.

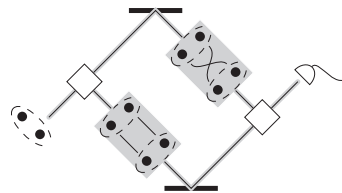

On the upper path the two particles are swapped using some operation ‘S’, while on the lower path they are left invariant—that is, the identity operation I is applied. The entire physical set-up is described by a bipartite state, one partition of which corresponds to the state of the particles, $|s\rangle \in \Omega_{P'cle}$, and the other to the ‘which path’ information embodied in the interferometer, $|s'\rangle \in \Omega_{Path}$. The entire scenario thus takes place in the state space $\Omega_{Path} \otimes \Omega_{P'cle}$. In the quantum case, the phase transformation generated by this procedure corresponds to the type of indistinguishable particle employed in the experiment.

The whole experiment can be described via a controlled transformation, with path information as the control and particle state as the target. Via theorem (2), such an experiment exists in theories satisfying our assumptions. Applying operation S to the particle state corresponds to swapping a pair of indistinguishable particles and so must leave the statistics of any measurement invariant. Therefore $S|s\rangle = |s\rangle$, where $|s\rangle$ is the initial particle state

$$\begin{array}{c} \Omega_{Path} \\ \hline \text{---} \\ \hline C \\ \hline s \\ \hline \text{---} \\ \hline \{I, S\} \end{array} \quad \text{where} \quad \begin{array}{c} s \\ \hline \text{---} \\ \hline S \\ \hline \end{array} = \begin{array}{c} s \\ \hline \text{---} \\ \hline \end{array}$$

Theorem (2) tells us that the above diagram corresponds to a kicked-back phase on the control system, as in equation (9). Thus, to every particle type, there exists a corresponding phase transformation, which was the connection discussed in [23]. But, in an arbitrary theory, the converse is not necessarily true. The quantum phase group is $U(1)$ and, fixing its representation to be $\{e^{i\theta}\}$, bosons kick-back the transformation corresponding to $\theta = 0$, fermions $\theta = \pi$ and anyons any arbitrary θ . Thus, to every particle type in quantum theory there is an associated phase, and vice versa.

To generalise this to theories satisfying our three assumptions, we must connect the operational description of these theories to the more physical notion of particles. Towards this end, we make the following two assumptions:

- (1) Every operational state $|s\rangle$ corresponds to the state of some collection of indistinguishable particles.
- (2) Every transformation that leaves the operational state $|s\rangle$ invariant corresponds to a (possibly trivial) permutation of the collection of indistinguishable particles.

Given the above, theorem (3) tells us that to every phase transformation there exists a corresponding particle type. Therefore, to each higher—order phase—described in theorem (1)—there is associated a particle type that should be observable through a generalisation of the above experiment.

Consider $|s\rangle$, which corresponds to the state of some collection of indistinguishable particles, and a permutation operation π which leaves $|s\rangle$ invariant. Note that, for a given permutation, there may be multiple topologically distinct ways of performing it, particularly in two-dimensions or topologically non-trivial spaces. Now consider the n -path experiment, illustrated below, where on each path some distinct permutation operation π_i , $i = 1, \dots, n$, takes place.

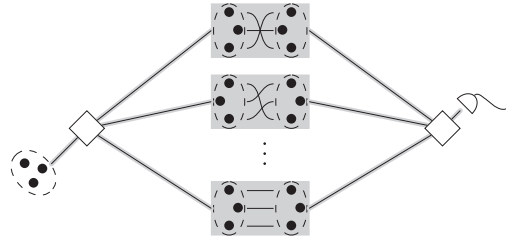

This can be described by a controlled transformation $C\{\pi_i\}$. Given the above two assumptions, any n th-order phase—if they exist in the operational theory—can be kicked-back by such an experiment.

Recall that n th-order phases are n -detectable, but $n - 1$ -undetectable. That is, the action of such phases cannot be detected by any effect with support on less than n paths. Which is in stark contrast to quantum, or 2nd-order, phases, which can always be detected by an effect with support on two paths. Thus, permutations of particles, whose type all correspond to an n th-order phase, can only be detected by recombining *all* paths in an n -path experiment. In some sense then, n th-order phases encode holistic information about all paths in an n -path experiment.

3.2. Computational oracles

Oracles play a vital role in quantum computing, forming the basis of most known speed-ups over classical computation [4]. Despite their importance, defining a general notion of oracle—that reduces to the standard notion in the quantum case—in operationally defined theories has proven difficult [9]. A particular example of a quantum oracle is the following controlled unitary:

$$U_f = |0\rangle\langle 0| \otimes Z^{f(0)} + |1\rangle\langle 1| \otimes Z^{f(1)}, \quad (10)$$

with Z a Pauli matrix, $f : \{0, 1\} \rightarrow \{0, 1\}$ a function encoding some decision problem and $Z^0 := \mathbb{I}$. The quantum phase kick-back for U_f amounts to

$$U_f = \mathbb{I} \otimes |0\rangle\langle 0| + Z^{f(0) \oplus f(1)} \otimes |1\rangle\langle 1|. \quad (11)$$

One can see that inputting $|+\rangle|1\rangle$ and measuring the first qubit in the $\{|+\rangle, |-\rangle\}$ basis reveals the value of $f(0) \oplus f(1)$ in a single query of the oracle—a feat impossible on a classical computer [4].

The results of theorem (2) provide a way to define computational oracles in any theory satisfying our three assumptions. An oracle in such theories corresponds to a reversible controlled transformation⁸, where the set of transformations $\{T_{i,f(i)}\}$ being controlled depend on a function $f : \{i\} \rightarrow \{0, 1\}$ encoding a decision problem of interest. As the transformations $T_{i,f(i)}$ depend on the value of $f(i)$, so does the controlled transformation and the kicked-back phase. That is, in theories with a non-trivial phase group, the phase kick-back of an oracle encodes information about the value $f(i)$ for all i . In such theories, there is thus a non-zero probability of extracting such global information. Non-trivial interference behaviour can thus be seen as a general resource for non-classical computation.

In the quantum case, there is a limit to how much global information one can obtain in a single oracle query. In the situation where $f : \{0, \dots, n - 1\} \rightarrow \{0, 1\}$ a quantum oracle can only extract the value of $f(i) \oplus f(j)$, for some i, j , in a single query without error [4]. Can theories with higher-order interference reliably extract more global information about f —without error—in a single query? The results of section (3.1) appear to suggest that n th-order phases encode information about all paths in an n -path experiment, as opposed to 2nd-order, or quantum, phases which only encode information about at most two paths. Based on this fact—that higher-order phases encode more holistic information than quantum ones—and the result of theorem (3), we conjecture that theories with higher-order interference can solve problems intractable on a quantum computer. To prove such a conjecture however, a concrete example of such a theory is needed. While there are partial

⁸ There could be many distinct transformations that have the same behaviour on a set of control states. As long as one fixes which transformation corresponds to the oracle, this is not a problem.

examples in the literature [24, 25], none of these are complete [26]. Answering such a conjecture in the affirmative is thus not yet possible, although some evidence was provided in [26].

4. Conclusion

The key result of this paper was to provide a set of physical principles that are sufficient for the existence of reversible controlled transformations. Such transformations are central to our understanding of quantum computing, information processing and thermodynamics. Moreover, these were shown to guarantee the existence of a generalised phase kick-back mechanism, which, in the quantum case, forms a fundamental component of almost all algorithms. These physical principles are defining characteristics of information: independence of encoding medium; propagation from present to future; and conservation at a fundamental level. It would therefore be surprising if these principles were not necessary primers for information processing. These results provide the tools for an exploration of the structure of computational algorithms—and how they connect to physical principles—in operational theories.

We developed a framework that connects higher-order interference and phase transformations, generalising the intimate connection between phase and interference witnessed in quantum theory. These ‘higher-order’ phases are accessible via our generalised kick-back mechanism. Given two assumptions which connect the operational theory to a physical description of particles, these higher-order phases were shown to give rise to exotic particle types. Additionally, using the controlled transformations to define an oracle model of computation, we conjectured that these higher-order phases may allow for the solution of problems intractable even on a quantum computer. Computational problems that may be susceptible to efficient solution by generalised phase kick-back include the n -collision problem, and the non-abelian hidden subgroup problem. Discovering that higher-order interference leads to ‘unreasonable’ computational power may provide a reason ‘why’ quantum theory is limited in its interference behaviour—in the same way that implausible communication complexity is thought to limit quantum non-locality [10].

In section (3.1) it was shown that to observe the exotic particle types corresponding to higher-order phases, there must be distinct ways to swap particles. As we live in a topologically trivial three-dimensional space, there is only one topologically distinct way to swap point particles. This can either be seen as evidence of *why* quantum theory is limited to only second-order interference, or evidence that such particle types must have non-trivial structure, similar to toroidal anyons [27]—which are constructed from a solenoid ring with an attached charge—or closed strings [28].

Finally, reference [29] has shown that thermodynamic work can be extracted from quantum coherences—2nd-order phases in our language. This raises the question of whether one can extract work more efficiently using higher-order phases? If such efficiencies are in contention with thermodynamic principles this could provide a reason ‘why’ quantum theory has limited interference. Initial investigations into formulating a consistent thermodynamics in operational theories have been reported in [32–34]. The framework and results presented here may therefore have implications for thermodynamics, information processing and how each arises in a unified manner from physical principles.

Acknowledgments

The authors thank Oscar Dahlsten, Terry Rudolph, Jon Barrett and Matty Hoban for useful discussions. Matty Hoban is also thanked for proof reading a draft of the current paper. This work was supported by EPSRC through the Controlled Quantum Dynamics Centre for Doctoral Training and the Oxford Department of Computer Science. CL also acknowledges funding from University College, Oxford.

Appendix A. General results following from causality purification and strong symmetry

A.1. Uniqueness of distinguishing measurement

Strong symmetry (together with the no restriction hypothesis, which says that all mathematically well-defined measurements are physical) implies that, given any set of pure and perfectly distinguishable states $\{|i\rangle\}$, there exists a unique measurement $\{|j\rangle\}$ such that

$$\langle i|j\rangle = \delta_{ij}.$$

See [11, 22] for details. Moreover if there is a set $\{|e_j\rangle\}$ such that $\langle e_j|i\rangle = \alpha_j \delta_{ij}$ then

$$\langle e_j| = \alpha_j \langle j|.$$

A.2. Existence of a maximally mixed state

Purification implies that there is a unique *completely mixed* state $||\mathbb{1}\rangle$ defined by

$$T||\mathbb{1}\rangle = ||\mathbb{1}\rangle, \quad \forall T \in \mathcal{R}$$

Any state is a ‘refinement’ of this state. See [5, 6] for details.

A.3. Purification of the maximally mixed state is dynamically faithful

Purification implies that there exists a state $|\psi\rangle$ that purifies the completely mixed state:

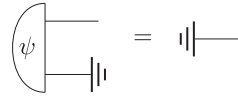

This is unique up to reversible transformation. We denote a particular choice of this purification as

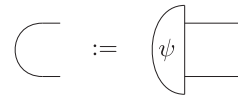

Purifications of the completely mixed state are called *dynamically faithful* states [5, 6] and satisfy the following important condition [5, 6]:

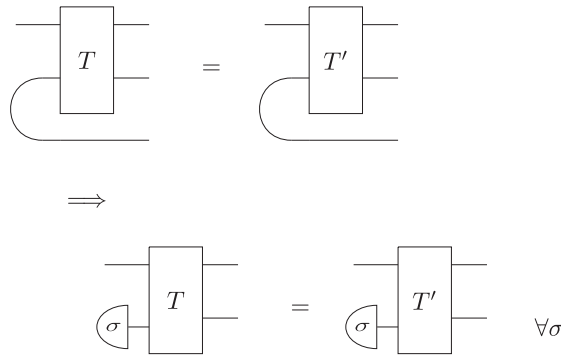

Appendix B. Existence of controlled transformations

We can define two sets of pure and perfectly distinguishable states

$$\mathcal{B}_1 := \left\{ \begin{array}{c} \text{semi-circle } i \\ \text{C-shaped wire} \end{array} \right\}, \quad \text{and} \quad \mathcal{B}_2 := \left\{ \begin{array}{c} \text{semi-circle } i \\ \text{C-shaped wire with box } T_i \end{array} \right\}.$$

Strong symmetry implies that there exists a reversible transformation between these two sets, $T : \mathcal{B}_1 \rightarrow \mathcal{B}_2$

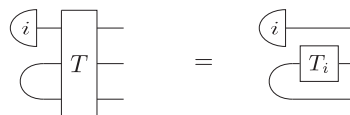

This result, together with the existence of dynamically faithful states, will be used to show the existence of a reversible controlled transformation $C\{T_i\}$ for an arbitrary set of reversible transformations $\{T_i\}$.

Lemma 3. ‘*Superposition preservation*’

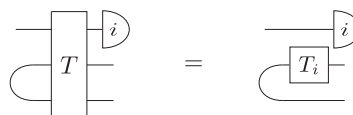

Proof. Firstly we prove a weaker condition which is superposition preservation for pure local effects

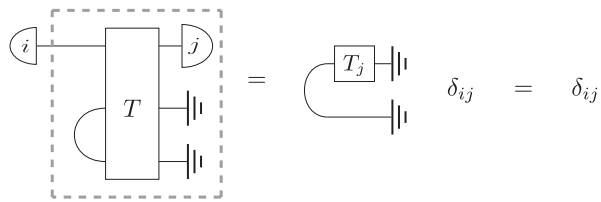

Strong symmetry \Rightarrow

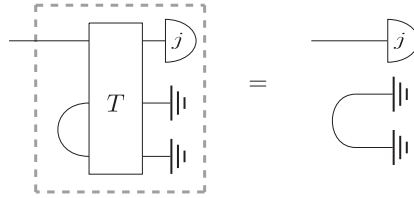

the implication follows from the uniqueness of the maximally distinguishing measurement up to normalisation. Then purification implies

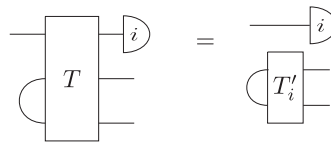

Now consider

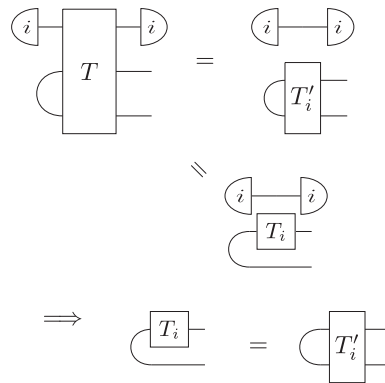

where the above follows the fact that $\langle i|i \rangle = 1$. This, in conjunction with the previous results, gives:

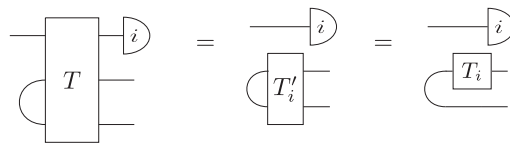

□

Lemma 4. $\exists T'$ such that

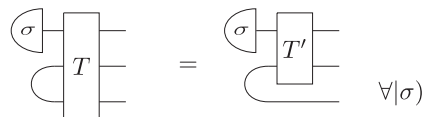

Proof.

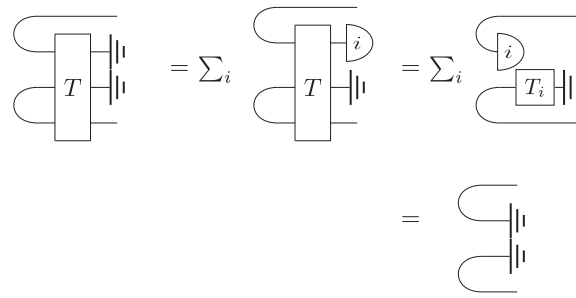

Purification \implies

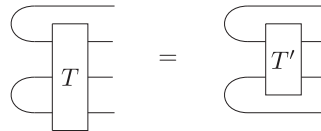

Dynamic faithfulness then gives the result. □

Theorem 4. T' is a controlled transformation, $T' = C \{T_i\}$.

Proof.

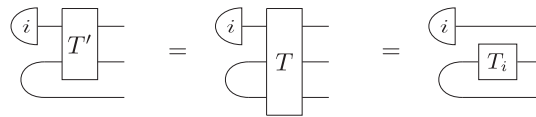

Dynamically faithful state \implies

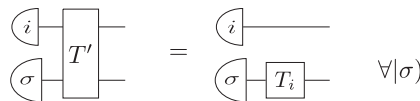

which is the defining characteristic of $C \{T_i\}$. □

Appendix C. Superposition preservation

Lemma 3 already gives some notion of superposition preservation, we can use our other results above to extend this.

Proof.

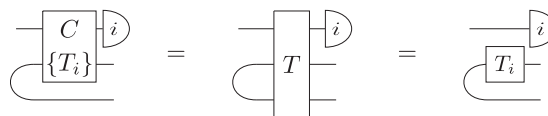

The first equality uses theorem 4 and the second lemma 3. Using the result of dynamically faithful states then implies

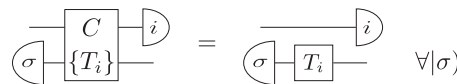

□

This actually only proves the existence of a controlled transformation that preserves superpositions, it is simple to show that it must be true for all controlled transformations using an argument analogous to lemma 3.

Appendix D. Definition of higher-order interference

The original definition of higher-order interference was in the framework of quantum measure theory [17, 18]. The definition revolves around the concepts of ‘histories’ and the ‘quantum measure’. Histories correspond to paths through space–time, a set of histories A is any collection of these paths. We will be concerned with sets of histories with some initial condition s and some final condition e along with an intermediate condition i that ‘the history passes through slit i ’. We label these sets of histories A_i^{se} . In an interference experiment it is common to

have some way to create a path difference between the different slits, either by introducing some ‘phase shifter’ or by moving the final detection point, we label this data t .

The quantum measure μ associates some probability to each set of histories, which should be thought of as the probability that a particle ‘has a history from that set’. In general μ will depend on the experimental control t .

The existence of higher-order interference in this framework is as follows:

Definition 13. n th order interference $\iff \exists s, e \text{ s. } t.$

$$\mu \left[\bigcup_{i \in \mathbb{P}} A_i^{se} \right] (t) \neq \sum_{I \subset \mathbb{P}} (-1)^{n-|I|+1} \mu \left[\bigcup_{i \in I} A_i^{se} \right] (t).$$

Given this definition we can provide a translation to the operational definition that we are using

	QMT	GPT
Initial condition	s	$ s\rangle$
Final condition	e	$\langle e $
Experimental control	t	T
Probability of path i	$\mu [A_i^{se}](t)$	$\mathcal{C}_{se\{i\}}(T)$
Probability of subset I	$\mu [\bigcup_{i \in I} A_i^{se}](t)$	$\mathcal{C}_{seI}(T)$

Note that some ambiguity is introduced in switching to the operational framework, which $e_I \in \mathcal{E}_I$ should be picked? Other approaches to defining higher-order interference in operational theories [11] have required sufficient structure to define a set of ‘filters’, $\{F_I\}$, for the theory. These are transformations that represent the action of leaving open some subset of slits I while closing the others, in which case $\langle e_I| = \langle e|F_I$. However, arbitrary theories do not have sufficient structure to define filters and so one must consider all possible choices $\langle e_I|$ with the correct support. This leads to the following definition of n th-order interference.

Definition 14. n th order interference $\iff \exists s, e \text{ s. } t.$

$$\mathcal{C}_{s,e}(T) \neq \sum_{I \subset \mathbb{P}} (-1)^{n-|I|+1} \mathcal{C}_{s,e_I}(T),$$

$\forall \langle e_I| \in \mathcal{E}_I.$

The introduction of the ‘ \forall ’ statement compared to the original definition is due to the ambiguity in choosing which effect corresponds to blocking some subset of paths. In the main text the explicit dependence on T in the above equation will be suppressed, as \mathcal{C}_{se} has already been defined as a function from the phase group to probabilities.

For example, the existence of second-order interference implies that there exists $|s\rangle$ and $\langle e|$ such that

$$\mathcal{C}_{s,e} \neq \mathcal{C}_{s,e_{\{0\}}} + \mathcal{C}_{s,e_{\{1\}}},$$

$\forall \langle e_{\{i\}}| \in \mathcal{E}_i.$ While the existence of third-order interference corresponds to the existence of $|s\rangle$ and $\langle e|$ such that

$$\mathcal{C}_{s,e} \neq \mathcal{C}_{s,e_{\{0,1\}}} + \mathcal{C}_{s,e_{\{1,2\}}} + \mathcal{C}_{s,e_{\{2,0\}}} - \mathcal{C}_{s,e_{\{0\}}} - \mathcal{C}_{s,e_{\{1\}}} - \mathcal{C}_{s,e_{\{2\}}},$$

$\forall \langle e_I| \in \mathcal{E}_I.$

We consider the above for the case of quantum theory to provide some intuition for the definitions. Firstly, we show the existence of second-order interference. Define our paths by $p_i := \langle i| \langle i|, |i\rangle \langle i|$, then choose $|s\rangle = |+\rangle \langle +| = \langle e|$. Then $\langle e_{\{i\}}| \in \{r_i |i\rangle \langle i|\}$, where r_i is an arbitrary positive real number. The phase group is given by $\mathcal{P} := \{e^{i\theta_0}|0\rangle \langle 0| + e^{i\theta_1}|1\rangle \langle 1|\}$. It is then simple to show that

$$\mathcal{C}_{s,e}(T) = \cos^2 \left(\frac{\theta_0 - \theta_1}{2} \right),$$

while

$$\mathcal{C}_{s,e_{\{0\}}}(T) + \mathcal{C}_{s,e_{\{1\}}}(T) = \frac{r_0 + r_1}{\sqrt{2}}.$$

It is then simple to see that, as functions of θ_i

$$\cos^2 \left(\frac{\theta_0 - \theta_1}{2} \right) \neq \frac{r_0 + r_1}{\sqrt{2}},$$

for any choice of r_i , i.e. $(e_{\{i\}})$. Therefore—by our definition—quantum theory has second-order interference as we would expect.

Next we consider our definition of third-order interference for quantum theory. We consider a specific choice of $|s\rangle$ and (e) , and note that this can be simply—but tediously—generalised to all choices. Consider $|s\rangle = 1/3(|0\rangle + |1\rangle + |2\rangle)$ ($\langle 0| + \langle 1| + \langle 2|$) (e), and the phase group, $\mathcal{P} = \{e^{i\theta_0}|0\rangle\langle 0| + e^{i\theta_1}|1\rangle\langle 1| + e^{i\theta_2}|2\rangle\langle 2|\}$. Then let $(e_{\{i,j\}}) = \frac{1}{3}(|i\rangle + |j\rangle)(\langle i| + \langle j|)$ and $(e_{\{i\}}) = \frac{1}{3}|i\rangle\langle i|$. Note that these are sub-normalised effects. It is then simple to check our definition for this particular choice of $|s\rangle$ and (e) . The interference patterns can be written as

(1)

$$\begin{aligned} \mathcal{C}_{s,e}(T) &= \frac{1}{9} |e^{i\theta_0} + e^{i\theta_1} + e^{i\theta_2}|^2 \\ &= \frac{1}{9} \left(3 + \sum_{i>j} e^{i(\theta_i - \theta_j)} + e^{i(\theta_j - \theta_i)} \right), \end{aligned}$$

(2)

$$\begin{aligned} \mathcal{C}_{s,e_{\{i,j\}}}(T) &= \frac{1}{9} |e^{i\theta_i} + e^{i\theta_j}|^2 \\ &= \frac{1}{9} (2 + e^{i(\theta_i - \theta_j)} + e^{i(\theta_j - \theta_i)}), \end{aligned}$$

(3)

$$\mathcal{C}_{s,e_{\{i\}}}(T) = \frac{1}{9} |e^{i\theta_i}|^2 = \frac{1}{9}$$

and so

$$\mathcal{C}_{s,e}(T) = \sum_{i>j} \mathcal{C}_{s,e_{\{i,j\}}}(T) - \sum_i \mathcal{C}_{s,e_{\{i\}}}(T).$$

This proves that the particular choice of state $|s\rangle$ and effect (e) do not give higher-order interference for quantum theory. This can, however, be readily generalised to hold for any choice, and so demonstrates that quantum theory does not exhibit higher-order interference.

References

- [1] Aaronson S and Arkhipov A 2011 The computational complexity of linear optics *Proc. 43rd Annual ACM Symp. on Theory of Computing (STOC 2011)* pp 333–42
- [2] Shor P 1997 Polynomial-time algorithms for prime factorization and discrete logarithms on a quantum computer *SIAM J. Sci. Stat. Comput.* **26** 1484
- [3] Cleve R, Ekert A, Macchiavello C and Mosca M 1998 Quantum algorithms revisited *Proc. R. Soc. A* **454**
- [4] Nielsen M A and Chuang I L 2000 *Quantum Computation and Quantum Information* (Cambridge: Cambridge University Press) pp 339–54
- [5] Chiribella G, D’Ariano G M and Perinotti P 2010 Probabilistic theories with purification *Phys. Rev. A* **81** 062348
- [6] Chiribella G, D’Ariano G M and Perinotti P 2011 Informational derivation of quantum theory *Phys. Rev. A* **84** 012311
- [7] Barrett J 2007 Information processing in generalized probabilistic theories *Phys. Rev. A* **75** 032304
- [8] Hardy L 2011 Reformulating and reconstructing quantum theory (arXiv:quant-ph/1104.2066v3)
- [9] Lee C M and Barrett J 2014 Computation in generalised probabilistic theories (arXiv:quant-ph/1412.8671)
- [10] van Dam W 2005 Implausible consequences of superstrong nonlocality (arXiv:quant-ph/0501159)
- [11] Barnum H, Mueller M P and Ududec C 2014 Higher-order interference and single system postulates for quantum theory *New J. Phys.* **16** 123029
- [12] Niestegge G 2012 Conditional probability, three-slit experiments and the Jordan structure of quantum mechanics *Adv. Math. Phys.* **2012** 156573
- [13] Henson J 2015 Bounding quantum contextuality with lack of third-order interference *Phys. Rev. Lett.* **114** 220403
- [14] Ududec C, Barnum H and Emerson J 2011 Three slit experiments and the structure of quantum theory *Found. Phys.* **41** 396–405
- [15] Sinha U, Couteau C, Medendorp Z, Söllner I, Laflamme R and Sorkin R 2008 Testing Born’s rule in quantum mechanics with a triple slit experiment (arXiv:quant-ph/0811.2068)
- [16] Park D, Moussa O and Laflamme R 2012 Three path interference using nuclear magnetic resonance: a test of the consistency of Born’s rule *New J. Phys.* **14** 113025
- [17] Sorkin R 1994 Quantum mechanics as quantum measure theory *Mod. Phys. Lett. A* **9** 3119–27

- [18] Sorkin R 1995 Quantum measure theory and its interpretation (arXiv:[gr-qc/9507057](https://arxiv.org/abs/gr-qc/9507057))
- [19] Stahlke D 2014 Quantum interference as a resource for quantum speedup *Phys. Rev. A* **90** 022302
- [20] Garner A, Dahlsten O, Nakata Y, Murao M and Vedral V 2013 Phase and interference in generalised probabilistic theories *New J. Phys.* **15** 093044
- [21] Gross D, Mueller M, Colbeck R and Dahlsten O 2010 All reversible dynamics in maximal non-local theories are trivial *Phys. Rev. Lett.* **104** 080402
- [22] Mueller M and Ududec C 2012 The structure of reversible computation determines the self-duality of quantum theory *Phys. Rev. Lett.* **108** 130401
- [23] Dahlsten O, Garner A, Thompson J, Gu M and Vedral V 2013 Particle exchange in post-quantum theories (arXiv:[quant-ph/1307.2529-v2](https://arxiv.org/abs/quant-ph/1307.2529-v2))
- [24] Dakić B, Paterek T and Brukner Č 2014 Density cubes and higher-order interference theories *New J. Phys.* **16** 023028
- [25] Ududec C 2012 *Perspectives on the formalism of quantum theory* University of Waterloo
- [26] Lee C M and Selby J H 2015 Higher-order interference in extensions of quantum theory (arXiv:[quant-ph/1510.03860](https://arxiv.org/abs/quant-ph/1510.03860))
- [27] Afanasiev G N 1991 Quantum mechanics of toroidal anyons *J. Phys. A: Math. Gen.* **24** 2517
- [28] Zwiebach B 2009 *A first course in String Theory* (Cambridge: Cambridge University Press)
- [29] Korzekwa K, Lostaglio M, Oppenheim J and Jennings D 2015 The extraction of work from quantum coherence (arXiv:[quant-ph/1506.07875](https://arxiv.org/abs/quant-ph/1506.07875))
- [30] Coecke B 2010 Quantum pictorialism *Contemp. Phys.* **51** 1
- [31] Abramsky S and Coecke B 2004 A categorical semantics of quantum protocols *Proc. 19th Annual IEEE Symp. on Logic in Computer Science*
- [32] Barnum H, Barrett J, Krumm M and Mueller M 2015 Entropy, majorization and thermodynamics in general probabilistic theories (arXiv:[quant-ph/1508.03107](https://arxiv.org/abs/quant-ph/1508.03107))
- [33] Chiribella G and Scandolo C M 2015 Entanglement and thermodynamics in general probabilistic theories (arXiv:[quant-ph/1504.07045](https://arxiv.org/abs/quant-ph/1504.07045))
- [34] Chiribella G and Scandolo C M 2015 Operational axioms for state diagonalization (arXiv:[quant-ph/1506.00380](https://arxiv.org/abs/quant-ph/1506.00380))