

**Real-Time Stimulation for Exercising Complex
Systems Employing Adaptive Sensors and Sensor
Arrays**

David Murray

Thesis submitted as part of an EngD Research Degree Course

Department of Electronic and Electrical Engineering

University College London

8th April 2013

I, David Murray, confirm that the work presented in this thesis is my own. Where information has been derived from other sources, I confirm that this has been indicated in the thesis.

Thesis Abstract

This research investigates the current structure of the Ministry of Defence's procurement system, with particular emphasis on the procurement of military sensor systems. A lifecycle common test environment, with an appropriate commercial construct for its implementation, is proposed.

Sensor systems include radar, passive RF surveillance (ESM) as well as electro-optic, infrared, sonar and other acoustic monitoring systems that are used to gather intelligence for a number of purposes including

1. Pre-empting hostile acts
2. Reducing risk to friendly forces and non-combatants in danger zones
3. Informing and prosecuting attacks on hostile forces

Sensor systems often form part of larger systems, also called systems of systems. In some cases, a number of sensors are required to work together to improve information extraction by data or information fusion.

It will be seen that these are complex systems. They are often designed to adapt their modes of operation to meet evolving situations. In this way, they can optimise themselves to meet their deployment objectives. These are difficult systems to specify. Therefore, they are difficult systems to test; they are expected to respond to a large number of situations that cannot easily be defined in advance of their being encountered.

This research brings together technical and commercial initiatives to remove many of the existing discontinuities along the lifecycle of such projects. The discontinuities harbour technical and commercial discrepancies that detract from achieving delivery and cost targets. A pragmatic Test and Evaluation concept is defined. It is backed by a commercial process. Together they provide an independent way to deliver continuous lifecycle evaluation and test of sensor systems.

This research offers a quantifiable measure of military capability improvements that complies with Systems Engineering and Management good practice.

Definitions

It is useful at this stage to define some terms that occur in this research:

Clutter - Data of a similar nature to that emanating from an object of interest but actually emanating from sources that are not of interest. Clutter, therefore, needs to be removed when investigating items of interest and, by its nature, can be difficult to remove.

Data Fusion - Merging the outputs from two or more sensors (usually of different types) to gain more intelligence about a scene or target – can be done at signal level through to extracted data level

Electronic Support Measures - a generic term to include ECM (Electronic Countermeasures); ECCM (Electronic counter counter-Measures); EW (Electronic Warfare)

Enterprise - an organisation, especially a business, or a difficult and important plan, especially one that will earn money (*definition by Cambridge Dictionaries Online*)

Evaluation – estimation, usually using previous test results from associated requirements, of the risk involved that equipment will/will not perform as required – does not include testing.

Hardware-in-the-loop is a phrase that describes a system that includes hardware (in contrast to software models for example) that is used for testing or training. **Man-in-the-loop** is an associated phrase meaning that an operator forms part of the system being described.

Littoral - An area of sea close to land – the sea waves act differently to open sea, providing a different clutter response and sonar echoes are rapidly reflected between surface and bottom

Persistent - An object-orientated term – an object that remains for the life of the program

Primes - Prime contractors – the large defence manufacturers

Reflection – Diffuse - Reflected emissions in a general direction but not as general as isotropic or specific as specular i.e. as for light from a matte surface

Reflection – Isotropic - Equal emissions in all directions

Reflection – Specular - Reflected emission in a single direction, or narrow beam, (as for light reflections from a mirror)

Sensor Systems - radar, Infrared (IR), electro-optic (EO), sonar or other sensors and the processing equipment associated with them

Simulation – involves (usually) a software representation of the performance required of proposed or existing equipment. It can sometimes involve a hardware model, the key factor is that it utilises a representation of an item, not the item itself.

Stimulation – is the act of presenting specific known signals, data, or other inputs, to a real equipment or a simulation of it. The purpose is usually to carry out a test. In this thesis, it entails producing signals that would normally be encountered in the real world by the equipment that is being stimulated. Stimulation techniques include software simulation of the environment. The equipment being stimulated, usually for test purposes, may be physical equipment or a simulation of it. In this research, we do not seek to simulate the deliverable, but to stimulate it.

Supply chain - The collective name given to a Prime Contractor and a series of sub-contractors, possibly with Academic involvement, who come together to meet a customer's (often MoD) requirement

Synthetic Environment - A computer simulated situation that replicates features that would be experienced in the real world. In this case, it replicates targets moving and being observed by a sensor platform.

Testing – is the act of performing physical checks of equipment performance. Tests are performed by providing inputs and observing the response of whatever is being tested (software and hardware modules to full systems or system-of-system). The purpose is to gather general or specific information that can subsequently be compared to expected results.

Through-Life Capability Management – the concept that all equipments 'join-up' according to a grand plan and all stages of their life are planned in order to achieve the required capability at each stage of the plan

Tower of Excellence – MoD/Industry meeting organisations to share technical ideas, wishes etc, radar and EW being examples of Towers

Validation This comprises high-level tests or evaluation, generally with users involved. Attempts to answer the question "*By using this, can we achieve what we intended to achieve?*" It has an important distinction from Verification; popular usage often confuses the two.

Verification This attempts to answer the question "*Does it do what was asked for?*" This is often the extent of contractual checks of equipment acceptability upon delivery. It can also be a mix of evaluation and testing. See validation to identify the difference between them.

Waveform - Modulation applied to a radar-transmitted pulse. Returned signals, due to reflections from objects, can be correlated with the waveform to improve range discrimination; this is termed 'pulse compression'.

Abbreviations

The following abbreviations are used in this thesis.

| Abbreviation | Meaning |
|---------------------|---|
| AGC | Automatic Gain Control |
| ALIX | Atlantic Littoral Waters |
| AOF | Acquisition Operational Framework |
| CADMID CADMIT | A product lifecycle model favoured by the MoD (Concept; Assessment; Demonstration (or Development); Manufacture; In-Service; Disposal (hardware) or Termination (software)) |
| CBDA | Chemical and Biological Defence Establishment |
| CDA | Centre for Defence Analysis |
| CEPA | Common European Priority Area |
| COEIA | Combined Operational Effectiveness and Investment Appraisal |
| COTS | Commercial off the Shelf – a generally available equipment |
| CSV | Comma separated variables (file format) |
| DBS | Defence Business Service |
| DE&S | Defence Equipment and Support |
| DERA | Defence Evaluation & Research Agency |
| DIO | Defence Infrastructure Organisation |
| DIS (1) | Defence Industrial Strategy – an MoD White Paper Dec 2005 |
| DIS (2) | Distributed Simulation as used in the context HLA/DIS – standards for data exchange in military simulations |
| DLODS | Defence Lines of Development |
| DOAE | Defence Operational Analysis Establishment |
| DOAE | Defence Operational Analysis Establishment |
| DoD | (United States) Department of Defense equivalent to the UK's Ministry of Defence but organised differently |
| DoDAF | DoD Architectural Framework |
| DRA | Defence Research Agency |
| DSP | Digital Signal Processing |
| Dstl/DSTL | Defence Science & Technology Laboratory |
| DTED | Digital Terrain Elevation Data (a mapping system) |
| DTS | Defence Technology Strategy – an MoD White Paper Jan 2006 [1] |
| ENIF | Experimental Network Integration Facility |
| EO | Electro-Optic – a sensor type |
| EPP | Equipment Procurement Process |
| EPROM | Erasable Programmable Read-Only Memory |
| EPSRC | Engineering and Physical Sciences Research Council |
| ESM | Electronic Support Measures – see definitions |
| EUCLID | European Collaboration for the Long Term In Defence |
| EW | Electronic Warfare |

| Abbreviation | Meaning |
|---------------------|--|
| EXI | An Execution Interval – typically a burst of radar pulses that will be processed together – also called an Integration Interval (INTI) but modern processing is usually more complex than is portrayed by this older term. |
| FATS | Framework Agreement for Technical Support |
| FEDEP | Federation Development and Execution Process |
| FFT | Fast Fourier Transform |
| FPGA | Field Programmable Gate Array |
| FPOA | Field Programmable Object Array |
| GUI | Graphical User Interface |
| HLA | High Level Architecture – a DoD standard [2] – see also DIS (2) |
| HWIL | Hardware-in-the-loop |
| I/F | Interface |
| I/O | Input and/or Output |
| IF | Intermediate Frequency |
| INCOSE | International Council of Systems Engineering |
| INTI | Integration Interval – see EXI |
| I-Q | In-phase and quadrature signals used to represent complex signals |
| IR | Infra-red |
| ISAR | Inverse Synthetic-Aperture Radar (see SAR) |
| ITEAP | Integrated Test, Evaluation and Acceptance Plan |
| JEM | Jet Engine Modulation |
| KPM | Key Performance Measures |
| LIDAR | Light Detection and Ranging |
| LRU | Line Replaceable Unit – a part of an equipment that can be replaced when the equipment is deployed – without return to a workshop – usually a plug-in item |
| M&S | Modelling and Simulation |
| MoD | Ministry of Defence |
| MODAF | MoD Architectural Framework |
| NAO | National Audit Office |
| NATO | North Atlantic Treaty Organisation |
| Niteworks | Network Integration Test and Experimentation works |
| OMG | Object Management Group (Moderators for the Unified Modelling Language – UML) |
| PC | Personal Computer |
| PCI Express | A PC Interface protocol |
| PDW | Pulse Descriptor Word |
| PFI | Private Finance Initiative |
| PRF | Pulse Repetition Frequency |
| PRI | Pulse Repetition Interval |
| PT | Project Team – within DE&S |

| Abbreviation | Meaning |
|---------------------|--|
| R&D | Research and Development |
| RAID | Redundant Array of Inexpensive Discs |
| RAM | Random Access Memory |
| RCS | Radar Cross Section |
| RF | Radio Frequency |
| RF/IF | Radio Frequency/Intermediate Frequency (stages of a receiver) |
| RoI | Return on Investment |
| S/N Ratio | Signal to Noise Ratio |
| S&T | Science and Technology |
| SAR | Synthetic Aperture Radar (see ISAR) |
| SE | Synthetic Environment / Systems Engineering |
| SEDEP | Synthetic Environment Development and Exploitation Process |
| SIF | Shore Integration Facility (a naval facility on Portsdown Hill used for combat system integration) |
| SimTE | Simulation for Test and Evaluation – a study 2011 |
| SISO | System Interoperability Standards Organisation |
| SME | Small and Medium (sized) Enterprises |
| SOSA | System of Systems Approach |
| SRD | System Requirements Document |
| STAP | Space Time Adaptive Processing |
| SUT | System Under Test |
| T&E | Test and Evaluation |
| T&V | Test and Verification |
| The RTDC | Sponsoring Company – The Real-Time Data Company Ltd. |
| TLCM | Through-Life Capability Management – see definitions |
| TLM | Transaction Level Modelling |
| ToE | Tower of Excellence – see definitions |
| TV&V | Test, Verification and Validation |
| UAV | Unmanned Air Vehicle |
| UI | User Interface |
| UML | Unified Modelling Language – see OMG |
| UOR | Urgent Operational Requirement |
| UUT | Unit Under Test – a sub-system, system or system of systems |
| VHDL | VHSIC hardware description language. (VHSIC was a 1980's US very-high-speed integrated circuit program). |
| WEAG | Western European Armament Group |
| XML | Extended Mark-up Language |

Symbol Table

The following symbols are used in equations in this document

| Symbol | Meaning | Units |
|------------------|--|---|
| A_{tg} | surface area of the target | m ² |
| A_e | area of the detector | m ² |
| brg | bearing | radians |
| D | diameter of collecting lens | m |
| d | distance | m |
| d_r | distance | radians |
| G | gain of transmitting/receiving antenna | |
| k | Boltzmann constant | Watts / Kelvin/ Hz |
| $lat\ 1\ lon\ 1$ | position of one body | degrees latitude degrees longitude |
| $lat\ 2\ lon\ 2$ | position of a second body | |
| lat_1, lon_1 | First position of a body | |
| $lat_2 lon_2$ | Subsequent position of a body | |
| P_e | Power transmitted | Watts |
| P_r | Power received | Watts |
| R | Range | m |
| s | distance | m |
| T | temperature of the source being measured | Kelvin |
| t | time between events | Sec |
| tc | true course wrt North | Radians |
| T_0 | absolute temperature of the environment (noise reference temperature) | Kelvin (290K by definition) |
| u | initial speed | m/sec |
| v | final speed | m/sec |
| Θ | Angle in radians | radians |
| ϵ | emissivity | Watts/m ² |
| λ | wavelength | m |
| Σ | Optical reflection coefficient | |
| σ | radar reflector cross section | m ² |

(n) Equation References

[n] Bibliographic References

Acknowledgements

This research would not have been possible without the unstinting help that I received from the people listed here. I am particularly grateful to Kay (my wife) who made many sacrifices, due to my absence, when I was deeply involved in this research. As my co-director of the sponsoring company, she was also affected by the considerable financial commitments of this work.

I would like to express my gratitude to those within Academia who patiently explained issues as many times as it took for me grasp them. They include Prof George Pavlou, Prof Hugh Griffiths, Prof Chris Baker, Prof Andy Valdar and Dr Karl Woodbridge. Paul McKenna's positive approach and ability to remove obstacles is much appreciated.

My industry colleagues also provided much help and support. Their encouragement is much appreciated. I recognise the difficulty that I created for some of them by asking for data and endorsements that were difficult for them to provide. Their generous support included providing access to equipment and detailed explanation of the key technical issues associated with specifying and testing sensor equipments. They include George Fisher, Dr Keith Ward, Dr Andy Stove, David Craig, Colin Bell, Anders Lindberg, Dave Wilson and David Bean and others too numerous to include here.

I owe a debt of gratitude to MoD and Dstl personnel for providing insights into their status and future direction. They include Dr Dai Morris Head of Defence Capability and his staff, TEST PT, Programmes and Technology Group (PTG), Joint Electronic Surveillance (JES), Combat Systems (Air), Combat System (Maritime). Martin Bailey DE&S above water sensors special fit technical manager (DESJES-SF-AW) provided valuable information about EW sensors and an assessment of the research output in this area. Commander Ivor Humphrey and his staff provided a very helpful comparison between Service and DE&S perspectives, as well as information about current techniques. Dr Chris Mace's support for the concept described here and help with engaging with senior MoD personnel is greatly appreciated. Recently, I am grateful to ADS, a trade body for the aerospace industry, which has started a campaign to promote, to the MoD, the concept presented by this research.

By no means least, the new customers for equipment include Air Chief Marshal Sir Stephen Dalton, Air Vice-Marshals Ian Morrison and Graham Farnell and Air Commodores Susan Gray and Stu Evans. They all provided down-to-earth descriptions of what they need of their DE&S purchasing capability for the future. They also made clear the need for 'getting it right' when it comes to equipment delivery upon which lives depend.

I hope that I have done justice to the time and effort contributed by these people on my behalf; any deficiency in representing their views is wholly my responsibility.

Contents

| | |
|---|------------|
| Thesis Abstract | 1 |
| Definitions | 2 |
| Abbreviations | 4 |
| Symbol Table | 7 |
| Acknowledgements | 8 |
| Contents | 9 |
| 1 Introduction | 15 |
| 1.1 Background and Motivation..... | 16 |
| 1.2 Scope of this Research | 18 |
| 1.3 Current Limitations and Research Objectives..... | 22 |
| 1.4 Thesis Structure..... | 24 |
| 1.5 The Contributions of this Research..... | 25 |
| 2 Background | 27 |
| 2.1 Background to Procurement..... | 29 |
| 2.2 The Procurement Process | 41 |
| 2.3 Project Performance Analysis | 46 |
| 2.4 An Inside View – Interview Results | 54 |
| 2.5 Additional Motivation to Improve the Procurement Process..... | 61 |
| 2.6 Summary of Procurement Process..... | 63 |
| 2.7 Commercial Concerns | 64 |
| 3 Current State of the Art | 73 |
| 3.1 Procurement Options..... | 74 |
| 3.2 DE&S Guidance..... | 77 |
| 3.3 Systems Engineering | 81 |
| 3.4 Specifying & Measuring Radar Performance | 88 |
| 3.5 Visualisation and Simulation Software..... | 92 |
| 3.6 Technically Based Software Tools | 96 |
| 3.7 Testing Techniques..... | 98 |
| 3.8 When to Test..... | 104 |
| 3.9 Summary of Best Practice | 108 |
| 4 Research Topics | 111 |
| 4.1 Proposed T&E Enterprise Structure | 112 |

| | | |
|----------|--|------------|
| 4.2 | Proposed T&E Technical Solution | 118 |
| 4.3 | Spectrum Usage | 121 |
| 4.4 | Radar | 122 |
| 4.5 | ESM..... | 125 |
| 4.6 | Other Sensor Systems | 126 |
| 4.7 | Summary of Relevant Radar & ESM Parameters | 127 |
| 4.8 | Modelling and Synthetic Environments | 129 |
| 4.9 | Structure of a Suitable Synthetic Environment..... | 133 |
| 4.10 | Processing Issues | 154 |
| 4.11 | Design of the Test Shell..... | 161 |
| 4.12 | A Radar-ESM Architecture | 170 |
| 4.13 | Other Sensor Types..... | 182 |
| 5 | Extensions & Exceptions | 183 |
| 5.1 | Doppler Effects..... | 183 |
| 5.2 | Multi- Beam Handling | 185 |
| 5.3 | Phased Array Antennas | 186 |
| 5.4 | Mode Changes & Data Transfers | 188 |
| 5.5 | Clutter Extensions | 190 |
| 5.6 | Multi-Path Issues..... | 192 |
| 5.7 | Improved Target Resolution..... | 193 |
| 5.8 | Latency in External Signals | 195 |
| 5.9 | I/O Issues..... | 196 |
| 5.10 | Radar Frequency Control..... | 197 |
| 5.11 | Data Fusion Issues..... | 197 |
| 5.12 | Scenario Building Issues..... | 198 |
| 5.13 | Data Recording..... | 198 |
| 6 | Verification..... | 201 |
| 6.1 | Concept and Analysis stages | 205 |
| 6.2 | Design Stage | 208 |
| 6.3 | Manufacturing Stage..... | 218 |
| 6.4 | Summary of Visualisation Proposal..... | 224 |
| 6.5 | Summary of Test Shell Proposal..... | 225 |
| 6.6 | Summary of T&E Implementation Proposal..... | 226 |
| 7 | Summary, Conclusions, Further Work | 227 |
| 7.1 | Summary | 227 |
| 7.2 | Conclusions | 230 |
| 7.3 | Further Work..... | 233 |

| | |
|--|-----|
| References & Bibliography | 237 |
| Appendix A The Procurement Process History..... | 253 |
| A.2 Consolidation | 257 |
| A.3 SMART to DIS/DTS..... | 259 |
| Appendix B Recent Reforms..... | 263 |
| B.1 Review of Acquisition (Gray 2009)..... | 263 |
| B.2 Strategic Defence and Security Review (SDSR 2010)..... | 268 |
| B.3 Defence Reform 2011 (Levene)..... | 273 |
| B.4 Security Through Technology (Luff 2011) | 275 |
| Appendix C The Analysis Function | 277 |
| C.1 Towers of Excellence..... | 277 |
| C.2 Niteworks | 277 |
| Appendix D Major Projects' Analysis..... | 279 |
| D.1 Project Time and Delay analysis..... | 280 |
| D.2 Technical Performance..... | 281 |
| D.3 Method of Project Analysis | 282 |
| D.4 Programme and Technical Changes | 283 |
| D.5 Financial Adjustment..... | 284 |
| D.6 Cost of Change | 285 |
| Appendix E Procurement Options..... | 287 |
| Appendix F Software Tools – Summary Tables | 291 |
| Appendix G Radar Requirements' Research..... | 293 |
| G.1 Maritime Applications..... | 293 |
| G.2 Military Air Radar | 296 |
| G.3 Missile-borne Radars..... | 299 |
| G.4 Satellite Radars..... | 300 |
| G.5 Countermeasures..... | 301 |
| Appendix H Basic Geometry | 303 |
| Appendix I Design Verification..... | 305 |
| I.1 Target Return Amplitude and Range Verification | 305 |
| I.2 Motion Verification –macro-scale..... | 305 |
| I.3 Motion Verification – normal scale..... | 306 |
| I.4 Relative Motion Verification | 307 |
| I.5 Pre-pulse Timing..... | 307 |

| | | |
|-------------|---|-----|
| I.6 | Clutter on/off | 308 |
| I.7 | AGC Design Verification | 308 |
| I.8 | Range Gating Verification..... | 308 |
| I.9 | Bearing gating Verification..... | 309 |
| I.10 | Verification of Doppler Implementation..... | 309 |
| I.11 | Verification of Transmitted Waveform Design | 311 |
| I.12 | Verification of Beamshape Design | 312 |
| I.13 | Antenna pointing Angle Verification..... | 312 |

Figures

| | |
|---|-----|
| Figure 1 – Project Analysis Time and Cost..... | 47 |
| Figure 2 – Detailed Spend vs. Projects | 53 |
| Figure 3 - Procurement Relationships | 63 |
| Figure 4 – Ch3 Structure – Best Practice | 73 |
| Figure 5 - Contracting Methods’ Values..... | 75 |
| Figure 6 – CADMID Guidance | 77 |
| Figure 7 – ITEAP Guidance..... | 79 |
| Figure 8 – Systems Engineering Evolution..... | 81 |
| Figure 9 - A Simple Test Environment | 99 |
| Figure 10 - A More Complex Test Setup..... | 99 |
| Figure 11 - Alternative Depiction of a Complex Test System | 100 |
| Figure 12 – Other Potential Benefits | 102 |
| Figure 13 - Perspective of Testing Techniques and Lifecycle | 103 |
| Figure 14 – Project ‘V’ Diagram..... | 104 |
| Figure 15 – Project Spiral Model | 104 |
| Figure 16 – Proposed Structure to Meet T&E Needs | 113 |
| Figure 17 - Frequency Spectrum Usage..... | 121 |
| Figure 18 - Concept of Unified Specification and Testing | 130 |
| Figure 19 - Current Techniques – showing discontinuities | 131 |
| Figure 20 – The Concept Presented as a Test Shell..... | 131 |
| Figure 21 - Synthetic Environment Top-Level Class Diagram | 134 |
| Figure 22 - Bi Static and Monostatic Views | 138 |
| Figure 23 – Radar Reflections within a Scenario | 144 |
| Figure 24 - ESM Environment..... | 147 |
| Figure 25 - Radar Block Diagram | 149 |
| Figure 26 - An ESM Processor Block Diagram..... | 149 |
| Figure 27 - Possible Radar and ESM Data Fusion | 150 |
| Figure 28 - Synthetic Stimulation of a Data Fusion System..... | 151 |
| Figure 29 - Deployment of a Radar Stimulator..... | 152 |
| Figure 30 - Radar Pre-Pulse | 155 |
| Figure 31 - GPU Architecture..... | 158 |
| Figure 32 - FPGA Architecture | 159 |
| Figure 33 – Test Shell Design Process..... | 161 |
| Figure 34 - Radar Base-Band Stimulation Architecture..... | 171 |
| Figure 35 - ESM Test Deployment Diagram..... | 178 |

| | |
|---|-----|
| Figure 36 - ESM Stimulation Interaction Diagram | 179 |
| Figure 37 - Antenna in-the-loop Stimulation..... | 187 |
| Figure 38 – Improved Target Resolution | 194 |
| Figure 39 – Effect of Navigation Data Latency | 196 |
| Figure 40 – Side-Scanning Radar | 214 |
| Figure 41 – Transmitted Waveforms..... | 215 |
| Figure 42 – Raw and Compressed Data..... | 215 |
| Figure 43 – Doppler Plots – 2 EXIs | 216 |
| Figure 44 – Procurement 1971 - 2012..... | 254 |
| Figure 45 – Military Equipment Cost-Benefit Analysis | 256 |
| Figure 46 – Gray Proposal | 266 |
| Figure 47 – Levene’s Procurement Decision Making | 273 |
| Figure 48 – Project Spend Analysis..... | 279 |
| Figure 49 – Project Cost, Delivery Time and Project Time | 279 |
| Figure 50 – Project Time vs. Delivery Delay | 280 |
| Figure 51 – DLOD Performance of Main Projects 2010..... | 281 |
| Figure 52 – KPM Performance of Main projects 2010 | 282 |
| Figure 53 – PFI vs. Traditional Contracts by Value | 288 |
| Figure 54 – PFI Satisfaction Report..... | 288 |
| Figure 55 - Uses of Radar Satellites | 300 |
| Figure 56 - Radar Satellite Operators | 300 |
| Figure 57 – Platform-Target Slant Range Geometry | 304 |
| Figure 58 – a 10 M ² target return with and without 10 M ² clutter RCS..... | 308 |
| Figure 59 – Doppler - Approaching and Receding..... | 310 |
| Figure 60 – Waveform rising to 1 MHz..... | 311 |

Tables

| | |
|--|-----|
| Table 1 – Organisational Issues Relevant to this Research | 39 |
| Table 2 – Stakeholder Involvement in the CADMID Cycle | 44 |
| Table 3 – The 9 DLODs..... | 46 |
| Table 4 -- Changes in Performance since the Gray Report..... | 48 |
| Table 5 – Project Analysis Categories..... | 49 |
| Table 6 - Project Performance Data | 51 |
| Table 7 – Cost and Time Variances per Service..... | 52 |
| Table 8 – Project Performance Factors Relevant to this Research | 57 |
| Table 9 –Is Change Really Required?..... | 65 |
| Table 10 - Would the MoD Consider an SME in this Role? | 67 |
| Table 11 – Correlation between Perceived Needs and this Research | 69 |
| Table 12 - Comparison of Contract Types | 75 |
| Table 13 – SIF Test Shell – Perceived Benefits and Concerns..... | 101 |
| Table 14 - Contractual Instrument Best Practice | 108 |
| Table 15 – Proposed DLOD Delivery Responsibilities..... | 115 |
| Table 16 - Old vs. New Radar Band Nomenclature | 121 |
| Table 17 - Radar Applications and Functions Considered | 122 |
| Table 18 - Target Parameter Importance to Radar Types..... | 123 |
| Table 19 - Other Relevant Platform-Target Parameters | 124 |
| Table 20 – FPGA Families vs. features..... | 162 |
| Table 21 - Summary of Functions | 170 |
| Table 22 - Mode Parameters..... | 189 |
| Table 23 - Clutter Factors | 190 |

| | |
|---|-----|
| Table 24 - Parameters of Importance to Stakeholders | 204 |
| Table 25 – Services’ Equipment Allocation | 271 |
| Table 26 - Defence Political Structure | 275 |
| Table 27 -- Changes in Performance since the Gray Report..... | 280 |
| Table 28 – Project Analysis Categories..... | 283 |
| Table 29 – Other Modelling Tools | 291 |
| Table 30 - FEDEP/SEDEP Tools..... | 291 |
| Table 31 – Deeper Abstraction Level Tools | 292 |
| Table 32 – HWIL Tools | 292 |
| Table 33 - Air Traffic Surveillance Radars in the USA | 298 |

1 Introduction

This research proposes and evaluates a way to reduce the cost, risk and delivery timescales of military equipments that use sensor systems.

Sensor systems include radar, passive RF surveillance (ESM) as well as electro-optic, infrared, sonar and other acoustic monitoring systems that are used to gather intelligence for a number of purposes including

1. Pre-empting hostile acts
2. Reducing risk to friendly forces and non-combatants in danger zones
3. Informing and prosecuting attacks on hostile forces

Sensor systems often form part of larger systems of systems. In some cases, a number of sensors are required to work together to improve information extraction from their raw data, by data or information fusion.

These complex systems take many years to come to fruition, during which time technical and political objectives can change. The systems are often designed to operate intelligently, by adapting their modes of operation to evolving situations; they can be required to optimise themselves autonomously to meet the objectives of deploying them.

These are difficult systems to specify and, therefore, difficult systems to test, because of the large number of situations to which they are expected to respond. This makes it difficult assess the extent to which military capability improvement has been achieved.

There is a history of overspend and delay in their delivery. This research offers a way forward to reduce cost and risk in the delivery of these systems. It does this by proposing a technical solution founded upon effective Test and Evaluation (T&E), coupled with a commercial construct to fit into the MoD's purchasing process.

1.1 Background and Motivation

Ministry of Defence (MoD) Main Projects' Reports have been produced by the National Audit Office (NAO) each year for more than 20 years. These reports primarily analyse the performance of the MoD's Procurement Executive, who are responsible for managing the projects. NAO consistently reports delays, and overspends that detract from the technical excellence that is being achieved.

1.1.1 Sponsorship Motivation

The sponsoring company for this research has, for over 30 years, been providing test and evaluation equipment to the MoD and prime contractors. The author has been in the industry for somewhat longer and has accumulated experience in this specialist area. The required test and evaluation equipment is typically used near the end of the design part of the lifecycle; furthermore, it is usually a bespoke design for each application. This research brings that experience to bear in proposing an alternative approach. The objective of the work is to reduce risk and cost of producing military sensor systems.

The MoD stated in its Defence Industrial Strategy White Paper (2005) [3] that it wishes to purchase commercial off-the-shelf equipment and benefit from its re-use across projects and throughout the lifecycle.

4.17 In particular, we can:

increasingly accept COTS technology, standards, architectures, products or services, and use open standards and architectures, wherever security considerations permit, to reduce cost to MOD, limit the risk of obsolescence, extend the market for industry, and open it to the widest range of suppliers possible;

This research takes into account this MoD requirement and provides a way in which the sponsoring company can help provide a solution in the context of Test and Evaluation (T&E). This Engineering Doctorate research was

undertaken to inject the discipline of academic thinking to help optimise the approach. A number of other issues were taken into account, including the MoD's stated wish to involve small-medium enterprises (SMEs) and academia in the supply chain, to strengthen the UK's position and export potential. These statements and other documents are referenced in Chapter 2. Recent Government White Papers (see section 2.1.1) call for improved re-use, COTS products, and small company involvement in large projects. This leads the author to feel that this research is well placed for meeting its objectives, and those of the sponsoring company. Further, undertaking the research as an Engineering Doctorate, because it is aimed at commercial organisations, offers the opportunity to consider wider aspects than just the technical issues.

1.1.2 Procurement Executive Issues

The MoD's Procurement Executive is the Defence Equipment and Support Executive (DE&S) based at Abbey Wood Bristol. Their customers are the Defence Chiefs and others in the MoD. The equipment they supply is used as needed worldwide by the Services. Complexity has grown into the delivery system over the years such that by 2009 there were 277,780 UK armed forces [4] served by 85,730 civil servants [5], one civil servant for every three people in uniform (including those with 'desk-jobs'). Liam Fox made the following thought provoking (if politically motivated) statement:

“When Frederick Duke of York was preparing for the Napoleonic threat between 1792 and 1804 he increased the size of the Army from 50,000 to 500,000 - and he did it with 38 staff in Horse Guards.” **Liam Fox MP Conservative Party Conference Manchester 8th October 2009 [6]**

Unravelling this is a difficult task and beyond the scope of this research, however it is necessary to understand this situation so that the research outcome can be shaped to fit into the reorganised structure. Understanding the current structure, is addressed in Chapter 2

1.1.3 Related Factors

The time for this research is appropriate because the banking crisis of 2007 catalysed the situation of MoD overspends and delays. The new Government in 2010 faced a 'no money' situation and Bernard Gray's report of 2009 [7] illuminated the MoD scene with a clarity that, in my view, had previously been lacking. Beyond the rhetoric and minor adjustments that had previously been commonplace, this resulted in actions being taken to reform the situation. As pointed out by the Gray report, the re-organisations over many years have introduced resistance to change within DE&S. That resistance now forms part of the problem.

Accompanying this activity, parts of the MoD are listening to suggestions and ideas from the community. This author has had favourable reactions to this work from a Whitehall Capability Head, Chiefs of Staff and senior military players, as well as some project teams (PTs) in Abbey Wood. This is a very positive sign for the outcome of this research.

1.2 Scope of this Research

The scope of this research is to investigate the way that sensor based military equipments are specified, tested, evaluated and validated throughout their lifecycle. The intent is to identify a way to achieve this that is not specific to a project, or even a sensor application, and supports many sensor types. The further intent is that any necessary equipment should comprise COTS hardware and embody a very large element of re-use both between projects and throughout the lifecycle of a project. The necessary equipment evolved into a new category of test shell, as will be explained.

The scope includes:

1. An assessment of current techniques used for test and verification of complex systems. An assessment of commercial constraints experienced by DE&S and how they can be improved
2. The development of a working prototype of an equipment to deliver the benefits outlined above

3. Proposing a commercial construct to meets the needs of DE&S and other stakeholders that will enable them to achieve the objectives outlined above

The scope includes research into sensor technology as required for the purposes of testing. However, subject matter experts contributed to defining the needs for their specialist areas and assessing the effectiveness of the solution in meeting those needs. Radar and ESM sensor-equipment features were covered in the research period. Other sensor types remain to be added. In defining their needs, the subject matter experts were asked to identify their 'dream test equipment features'. These were explored with the experts to ensure that there were no misunderstandings arising from assumed technical implications. For example, the use of 'L-band' for radar implies that foliage penetration is expected. Certain RF bands have specific implications for ESM specialists interested in threat analysis. The research combined these wish lists, and other features identified from literature, to phase development of a test shell to meet those combined needs. Both technical and commercial issues were addressed. The radar and ESM subject matter experts then contributed to the detailed assessment of adequacy in testing the features of their specialist sensors.

A technical solution is not sufficient to address all of the issues that detract from a clear route between concept, delivery, and to In-Service support. A number of non-technical issues also need to be resolved and are identified as Enterprise changes – using a quotation from an interviewee (*page 55*).

Currently, the contractor responsible for delivery also reports the status of the project in relation to agreed milestones. A proposal is made for clarifying projects' delivery responsibilities by separating status measuring from those charged with implementing the project. MoD commercial and technical advisory staff contributed to the assessment of the commercial construct and the basic tenet of the technical approach.

1.2.1 Considerations

The test shell includes a modular structure into which more or less detailed elements required to deliver adequate tests can be inserted. This affects the generation fidelity when producing test signals. Commercial as well as technical requirements play a part in defining an acceptable level of fidelity. Technically, the level of fidelity of test signals can vary according to the type of testing needed. Commercially, it may not be cost effective to provide high fidelity signals where they are not needed. For example, some applications need high fidelity data (a SAR application is likely to need high-resolution targets), whereas other applications do not (tracking applications can operate with a 'blob' return). It is commercially pragmatic to meet the minimal need of the application, if exceeding it costs more money, time, processing power, memory or other resources.

A modular architecture is used to allow the range of applications to grow with minimal change to the structure – just appropriate modules. A typical exception would be to develop a lower fidelity system if a higher one already exists. The test shell described here has interchangeable functional elements, the fidelity of which can be extended or reduced to meet these varying needs. There is variation in the fidelity of the many elements implemented during the research period. Further work is recommended to address this.

It is a necessary and important aspect that all stakeholders understand and agree, by determining to their satisfaction, that the level of fidelity being offered is acceptable in relation to its purpose. In this Engineering environment, if one subject matter expert does not agree with a proposal, specification or decision, a compromise must be found. If the disagreement is based upon a scientific issue the same rules apply – a solution must be found. By definition, when they do agree it means that the important issues (to them) – including the scientific, issues will have been taken into account, and verified by one or more of inspection, measurement, calculation and demonstration. Commercial negotiations do not start until this has been achieved.

The proposed testing configuration is shown to cover the varying testing needs throughout the lifecycle of a project. This is an important distinguishing factor because current practice involves development of several bespoke solutions. These are specific to each sensor project (not even sensor application) at each of every project's lifecycle stage – many solutions with very limited life. There is currently no generic solution of the type developed here. However, it is possible that a bespoke solution to a specific test issue has better fidelity than the current iteration of the generic test shell. The concept is to subsume the features of such bespoke systems into the generic version as this becomes commercially viable. One such occasion is when updates to the bespoke systems become necessary.

1.2.2 Other Contributory Disciplines

Bodies of work in the domains of Systems Engineering, hardware and software techniques are drawn upon by this research. For example, an important misconception is that testing is something that is performed near the end of a project. In fact, it is applicable at all lifecycle stages.

'Serious games', that is computer games that are used for military training purposes, also contribute to this work. There is some benefit in joining such visual representations to a physical representation so that real equipment can be included in the training environment.

All specialisations have specific definitions for words that are also in general use. The test domain has specific understanding of the words test, evaluation, verification and validation, as defined on page 2. Physical testing may be replaced by evaluation of previous results to avoid duplication and waste of time and other resources. Testing would only be applied if there were insufficient information for an evaluation to be carried out. Evaluation and test are undertaken to verify that the intended functionality has been met (or not). They are also undertaken to validate requirements; that is to ensure that the correct objectives have been set and met (or not).

1.3 Current Limitations and Research Objectives

The research question is:

“Is there a way to improve the specification and monitoring of sensor procurement programs, such that there is one set of criteria from concept stage to delivery that can be used for all stages of development, that is independent of any particular program or supplier, with the aim of reducing risk and cost whilst offering support for future sensor fusion applications?”

In the above, the phrase ‘one set of criteria’ means that the performance objectives should not change in an uncontrolled way during the lifecycle of the procurement. This can be achieved by the same measurement of performance performed at an early stage also being applied to the later stages of the lifecycle.

Military procurement has been modified over the years to improve value for money and a well-trodden system is in place. Procurement of military sensor systems currently has the following limitations that are explained further in this thesis (primarily Chapter 3):

1. difficulties in converting military requirements into technical specifications
2. difficulties in evaluating competitive bids in a quantitative way that can be seen to be fair to all bidders
3. difficulties in quantitative monitoring of technical progress during the development period
4. risk of ‘requirements creep’ and ‘feature bloat’
5. expensive acceptance trials
6. disconnected training and support requirements
7. a test and verification process that is also disconnected along the lifecycle

The proposed test-shell contributes to resolving all of these issues (1-7).

Issues 2, 3 and 4 are also addressed by the proposed Enterprise changes. The changes achieve separating responsibility for evaluation and test of project status from implementation. However, a considerable amount of historical background makes such change difficult to instigate. These aspects are considered in the next chapter. Some issues, relating to radar only, have been addressed in a work that is summarised in the next section.

1.3.1 Specification and Measurement of Radar Systems

A seminal work in the area of radar procurement was a report sponsored by DSAC in 2002. Although the report is not published outside of MoD, a version of it was presented at the IEE 2002 Radar Conference [8]. It also formed the basis of a chapter in a book [9]; both of these are referred to later. The work describes clearly the issues involved in the “Specification and Measurement of Radar Systems”, which is the title of the report, the paper and the book chapter. The authors of the report represent a broad cross-section of the leading UK and world-level radar practitioners and thinkers employed by UK prime contractors and academia. The work relates to radar procurement. No other sensor procurements have been addressed in this way. That work is extended here in three ways.

- 1 It identifies a pragmatic way of achieving the specification and measurement objectives
- 2 It extends the scope from radar to other sensor types
- 3 It merges the contractual boundaries identified in the work

In addition, this research

- 4 Joins-up discontinuities in the technical evolution of sensor equipments over their lifecycle and includes specification, design, development, integration capability testing and operator training. Currently this is not done.
- 5 It is not project specific; the test capability emulates the environment not the sensors placed in it. Currently, bespoke test equipment is developed for each stage of the lifecycle for each project.
- 6 It supports multiple sensor types in a single common environment – as required for testing data and information fusion systems. Currently,

test equipments are specific to a sensor type on a project. Higher-level integration and testing for such applications relies on costly real-world testing.

Achieving a pragmatic way to meet these objectives is central to this research.

1.4 Thesis Structure

A review of the current procurement process in the MoD is undertaken in chapter 2. The current objectives and outcomes are compared and found to be inconsistent, before the causes are analysed from key-points presented in Table 8 on page 57.

Clearly, this is a big area to consider, particularly by a Small to Medium size Enterprise (SME) such as the company sponsoring this work. Six questions are asked in section 2.7 to establish the viability of the sponsorship continuing to explore the hypothesised solution. The findings were clearly positive or this thesis would not exist.

The 6-questions response (also in section 2.7) triggered the state-of-the-art research presented in chapter 3 that reviews a range of topics related to the proposed solution. Attention is drawn to the review of 'The Specification and Measurement of Radar Performance' [10] that is a seminal work in this area and inspired this research. This research aims to build a pragmatic solution to the issues posed by this work and, importantly, extend it to other sensor types.

The MoD's procurement system is undergoing significant change because of such issues as those identified in chapter 2. The Enterprise solution, presented in 3.10, addresses a small part of the overall change but is significant if the previous issues are to be avoided in the future. The technical issues that this research proposes to complement the Enterprise solution in such a way as to address the issues identified in chapter 2, and also to align with the seminal work, are presented in chapters 4 and 5

The research concept is evaluated in chapter 6 where the ability of the technical solution to meet technical and lifecycle issues is explored. Chapter 7 draws together these strands, summarising the outcome of the research and the areas for further work identified throughout the thesis.

1.5 The Contributions of this Research

This research makes the following contributions to the body of knowledge. It will be appreciated that, unlike a pure scientific approach, an Engineering approach takes a holistic view that includes technical and commercial issues as well as human factors and other issues.

1. It provides an improved T&E capability that
 - a. is tuned to measure military capability improvements
 - b. provides a means to improve stakeholder communication so that all have a better understanding of technical commercial, political and operational issues
 - c. supports multi-sensor applications – for example to support data fusion applications
 - d. is small flexible and of (comparatively) low cost
 - e. can be used throughout the lifecycle of a project
 - f. is not project specific – meaning it can be re-used on projects with sensors of the same type(s)
2. It proposes and facilitates T&E becoming an independent and identified activity to inform managerial and technical decisions without the potential conflict that currently exists.
3. It identifies a way to help the Government achieve its intent that SME companies should be allocated around 25% by value of all contracts¹ let
 - a. This offers opportunity to strengthen the supply chain, and reap benefit from the perceived characteristics of an SME², in a clear and visible way by fulfilling 3 above.

¹ 'National Security Through Technology' also called 'The Luff White Paper' Feb 2012 [11] para 193)

² " SMEs typically possess characteristics that are particularly important when meeting defence and security requirements. These include agility, flexibility, genuine innovation, commitment, customer focus, lower overheads, and often niche or specialist skills and capabilities. These competitive advantages can help us get more value from our investment in defence and security capabilities. " – p22 [12]

4. It is intended that the contingency budgets, of 50%-70% allocated to projects when contracts are let, should be at least partially saved. It is intended that contribution from the implementation of the work derived from this research will cost less than this contingency amount. Although work has been done to speculate what the savings might be, this was not able to be tested during the duration of this research and so remains an objective. It is included to indicate that a holistic approach was considered during this research. This is consistent with the objective that an EngD should be undertaken in an environment of “strong business focus”³.

³ The EPSRC Industrial Doctorate Centre Scheme Good Practice Guidance 2009 – page 2 point 2

2 The Industrial Doctorate Centres (IDCs) are a development of EPSRC’s EngD centres, and the objectives for IDCs are;

- Innovative and exciting training environments across the EPSRC remit.
- Drawing / building on a base of research excellence.
- Production of highly skilled and talented people
- **User orientated i.e. strong business focus** (*my highlighting*)

2 Background

In 2010, 30 projects were defined by the National Audit Office (NAO) as ‘major’ technical projects being managed by the MoD’s Project Teams (PTs) that were reported in the National Audit Office Report (2010) [13]. They included Type 45 Frigate; the Astute submarine; the Nimrod MRA4 aircraft; a new Airborne Refuelling Tanker; a new networked-communications system, as well as dismounted soldier support contracts. The diversity of the skills needed to handle these procurements is wide, taking in many Engineering disciplines, plus military operational understanding as well as human factors and politics.

The budget for one project exceeds £10bn (this is more than the GDP of 53% of the countries in the world⁴). Eight projects have budgets in the range £1-5bn (46% of the countries of the world have a GDP less than £5bn¹); 18 projects have budgets in the range £100M to £1bn, the rest are below £100M. The management skills needed to handle budgets of this size are significant. This is exacerbated by the timescale from concept to delivery to the front-line, often exceeding 10 years, and the equipment often being in service for 30-50 years.

It can be seen that a small percentage saving in expenditure represents a significant value when expenditure is on this scale, especially in these days of austerity. Much effort is being expended to find ways of making such savings and this research offers a contribution to that.

To this end, this Chapter reviews the way in which the MoD Procurement has evolved. It can be seen that there have been many changes and this can result in ‘change-fatigue’, where any further change is resisted. This situation has existed for many years and the resistance, at best apathy, has been experienced within that organisation during this research. It will be shown that the Gray report, backed by the Levine report, (see section 2.1)

⁴ Taken from World Bank figures 2009: <http://www.worldbank.org>.

sets out to change this. Changes are being implemented in 2011-2012 that previously would have been unimaginable. Not least amongst these is balancing the Defence budget and accepting the political cost of serious redundancies during a time of conflict. This attitude provides a window through which the changes proposed in this research can shine. The current processes used by the MoD for procurement, (section 2.2) and the NAO reports (see section 2.3) that measure their effectiveness, provided this research with data that has been used to indicate what types of change would have the most effect. The emergent holistic picture of the status of the MoD's procurement was corroborated by interviews conducted with practitioners within MoD procurement and related departments (see section 2.4). This background, coupled with a review of political motivation (section 2.5), makes a good case for this research to be of value.

Following this, Chapter 3 reviews and analyses the 'best-practice' techniques available in relation to equipment procurement.

2.1 Background to Procurement

This research has considered the background to defence procurement from around the time of the First World War to the present time. The detail is presented in Appendix A from which the following points are particularly relevant.

- 1 The role of the Chiefs of Staff in relation to Government has changed
- 2 The role of the Chiefs of Staff in relation to procurement has changed
- 3 A Department was set up for purchasing military equipment. It has changed shape and reporting structure over the period. Currently this is the Defence Equipment and Support organisation - DE&S.
- 4 Technical responsibility is devolved to another organisation that has changed its shape, size and reporting structure many times over the period. Resulting from these changes, Dstl⁵ deals with issues that have a high security classification and with technical aspects of interactions with foreign governments. Various other activities are sub-contracted to industry and technical organisations, for example Towers of Excellence⁶ and Niteworks⁷, as they are required.
- 5 The size of these organisations have grown and shrunk in addition to being re-organised.

Many of the DE&S staff are career Civil Servants who will have been affected by these changes. Furthermore, they will have experienced the effects reported by the NAO year after year and this all adds up to be the norm for their jobs. Any change, no matter how well intended, becomes just another in a long series making it difficult for the change to be effective. Each change, at its introduction, is likely to have been heralded as THE change to fix all ills; it is not surprising that those affected become a little sceptical.

This is an important factor to be taken into account at this current round being introduced by Bernard Gray. However, it was time to do something

⁵ Dstl provide support where there is a high level of classification relating to UK security and areas where there are Government to Government links, particularly with the USA and, more recently, with France.

⁶ Towers of Excellence exist for specialist areas and comprise industry and academia with Dstl representatives.

⁷ a collaboration of private companies funded by the MoD via Dstl

radically different to avoid the effect of the adage ‘if we always do what we always did, we will always get what we always got’.

2.1.1 Recent Reform Proposals

The need for improved cost-awareness was accentuated by the reduced availability of money following the Banking crisis of 2007. The reported joking ‘no-money’ comment⁸, by the outgoing Chief Secretary to the Treasury to his successor following the 2010 change of Government, proved more prophetic than amusing and heralded general economic austerity.

Taking just the reform proposals since 2009, there have been 4 major ones and several minor ones that propose wide-ranging ways to improve aspects of the delivery of equipment to the front-line. The main ones are:

- 1 ‘The ‘Gray Report’ 2009 – ‘Review of Acquisition for the Secretary of State for Defence’ [14]
- 2 The UK coalition ‘Strategic Defence & Security Review 2010’ with a foreword by David Cameron (Conservative Prime Minister) and Nick Clegg (Liberal Democrat Deputy Prime Minister) [15]
- 3 ‘Levene Report’ 2011 Defence Reform: An independent report into the structure and management of the Ministry of Defence [16]
- 4 The ‘Luff White Paper’ 2012 Security Through Technology [17]

An analysis of these reports is of key importance to this research because it indicates the areas of reform that the Government is prepared to consider, along with their objectives and pace. This research must align closely with these objectives for it to be considered as part of the solution. Their relevance to this research cannot be overemphasised and they are analysed in the following sections.

⁸ “New Chief Secretary to the Treasury David Laws has revealed his predecessor left him a note reading: “I’m afraid there is no money.”” http://news.bbc.co.uk/1/hi/uk_politics/8688470.stm

2.1.1.1 *The Gray Report*

In the view of the author of this thesis, the Gray Report [18] can be considered to be the main disruptive force from which the other recent reforms have sprung. It can be appreciated that with nearly 100 years of evolving history it would take a disruptive approach to make significant change. In 2008, the Government declared that significant change was needed. The point was emphasised by the early retirement of Sir Jock Stirrup from the role of Chief of Defence Staff⁹. John Hutton, The Defence Secretary, appointed someone from outside the organisation to undertake a review.

Bernard Gray has a background in finance and was formerly Defence Correspondent for the Financial Times. He is not a career Civil Servant. His report is formally titled: “Review of Acquisition for the Secretary of State for Defence” and was produced in October 2009 [19]. It breaks the tradition of previous reports. Previous reports were very much ‘establishment’, meaning that there is a correct way to do things and a gentlemanly rule takes regard of personalities, careers and maintaining the status quo; any criticism being very muted. This is acknowledged in the Gray report although it breaks the rule. It takes a forthright and bold approach, possibly in an attempt to overcome the ‘forces working to overcome the status quo (p50).

“..any change needs to be system-wide and significant because trialling or small scale experimentation risks being strangled by the significant forces working to maintain the status quo.” [20] Page 50

The report is analysed in more detail in Appendix B.1. Although refreshing to some it was a threat to others. This unfortunate dichotomy did not make it easier to implement the changes that he advocated. It would take much more than the 12-months he proposed to create the improved organisation. He identified that the system is unable to predict cost accurately –“*Simply*

⁹ reported by Caroline Wyatt BBC BBC 13th June 2010 <http://www.bbc.co.uk/news/10304840>

put, many participants in the procurement system have a vested interest in optimistically misestimating the outcome." ([21] page 19).

This tone continues throughout the Gray report and a number of issues are identified, including the following. Their relevance to this research is provided in italic font:

1. There is inter Service funding rivalry that is not constructive (*by categorising with respect to sensor type rather than users means that, for example, radar applications for all Services can use similar tools and data sets – currently there is little or no correlation*)
2. It is considered acceptable to ask for equipment that is ‘just within the laws of physics’ rather than a planned growth of features (*the existence of a common test shell will allow much better evaluation of new ideas – it reduces the cost of performing the evaluation because the test and evaluation infrastructure (including common data sets) would exist*)
3. DE&S should develop an ‘going-concern’ mentality and take responsibility for delivering effective equipment to time and budget (*a built-in benefit when quantitative status measurements are possible*)
4. The skills within DE&S are not adequate for the job they are being asked to undertake. Unlike DGA (the French equivalent of DE&S) there are no technical skills being used for technical purposes (*these skills are proposed as part of its Enterprise change*)
5. The Capability groups need to be ‘joined-up’ with the Procurement Executive (*the lifecycle and stakeholder relationships are addressed by providing a readily comprehensible visualisation of progress re objectives – it also proposes using the same tools for all stages – the lifecycle approach*).

The Gray report makes eight recommendations of which the 5 most relevant to this research are summarised below:

1. There should be an Executive Committee responsible for costs (*this identifies a responsible group for decision making related to cost saving*)
2. Clarification of roles improve customer-supplier relationships (*supported by this research*)
3. Revise project approval process (*this research contributes by offering a quantitative way to assess capabilities*)
4. In-service support cost reductions – Through-Life Capability Management reviews¹⁰ suggest that there should be better grasp of through-life aspects of a project (*this research offers a way to deliver through-life T&E capability*)
5. Improve DE&S efficiency (*the Enterprise change supports this by providing DE&S with an in-built quantitative status assessment upon which they can base decisions*)

2.1.1.2 Strategic Defence & Security Review (SDSR 2010)

This Strategic Defence and Security Review (SDSR) [22], prefaced by the Prime Minister and his Deputy (Cameron and Clegg) is much more conciliatory and traditional in its presentation than the Gray report.

The objective of the SDSR, presented in more detail in Appendix B.2, is to support 1 long (6500 personnel) + 1 short (2000 personnel) + 1 simple (1000 personnel) or 1 limited (30,000 personnel) campaigns. The text from the review, describing these, is presented in Appendix B.2, page 270.

It offers all stakeholders something they would wish to hear couched in political phraseology. For example,

We will aim to support the small and medium-sized enterprises that are a vital source of innovation and flexibility (page 30)

Unfortunately, it lacks an implementation plan or identification of who is responsible for what and when it should happen.

¹⁰ Produced for the MoD by Mott MacDonald www.managementconsultancy.mottmac.com

Although the tone is not that of the Gray Report, the SDSR carries a tough message. It requires new non-frontline savings of at least £4.3 billion over the Spending Review period. There are 9 key areas, of which the following 4 are relevant to this research:

1. Reductions in the civilian workforce and non-frontline service personnel (see below) (*this research offers improved efficiency in evaluation of status to help compensate for reduced staff and money*)
2. Efficiencies and improvements in military training, including the increased use of simulators for air-crew and army live firing (*this research offers training features at all stages of the lifecycle and so it will be available with suitable efficiency by the in-Service date*)
3. Saving significant amounts from contract re-negotiations with defence industry (*T&E cost savings are offered because building the T&E equipment is common to the whole lifecycle and across projects of a similar type i.e. ESM, radar, sonar etc.*)
4. Reductions in spend on commodities, including substantial savings on energy and professional services (*this research offers a contribution by reducing the need for travel by offering a distributed T&E capability*)

Overall, this represents a 25% staff reduction in non-frontline organisations such as headquarters, support roles and organisations such as DE&S, saving at least £2 billion per year by 2014/15.

The SDSR identifies seven Military Tasks, five of which are particularly relevant to this research because they overtly involve sensor systems:

1. Defending the UK and its Overseas Territories
2. Providing strategic intelligence
3. Supporting civil emergency organisations in times of crisis
4. Defending our interests by projecting power strategically and through expeditionary interventions
5. Providing a defence contribution to UK influence

The SDSR identifies in detail the capital equipment to be provided for each of the Services – see Appendix B.2.4.

These definitions are of great significance to this research because they bound the immediate extent of the capability that needs to be addressed.

2.1.1.3 *The Levene Report*

The Levene Report “Defence Reform: An independent report into the structure and management of the Ministry of Defence” [23], echoes much of the Gray Report but in a lower-key tone. For example, it puts responsibility for organisation of the DE&S into the DE&S and specifically does not ‘offer a template’ for the way the re-organisation should look.

The report makes it clear that there should be a ‘Head Office’ function to deal with strategy. The report also states that the function should be separated from the delivery functions resulting from strategic decisions. The ‘Head Office’ function will be covered by Whitehall with a leaner and fitter structure than previously. Bernard Gray has been appointed as Chief of Defence Materiel (CDM) responsible for procurement of equipment defined by the Head Office Function. The reporting and responsibility structures are defined with some minor changes to that proposed in the Gray Report. These are not of significant consequence to this research, although the overall structure and this definition of functions are highly relevant because it identifies who is responsible for each of the aspects that the research aims to cover. It has been possible to approach some of these stakeholders and present to them the benefits (to their newly identified roles) that the research offers. This has been well received.

The report does not stipulate specific implementation routes, it makes the organisation responsible for ownership and implementation for which 3 particular guidance points are made in relation to this research:

“Greater use of analytical staff in handling information will also enhance decision making in Defence. We recommend the Department should also consider how best to use this expertise

(analysis) to draw upon relevant evidence, improve presentation, and clarify the issues for decision makers.” ([24] page 43 Para 8.2)

“on science and technology, such advice plays a very important role in supporting acquisition decision-making, and should be factored in to the process from an early enough stage. Science and technology advice should also be used more widely in support of decision-making across Defence.” ([25] page 52 para 11.5 bullet 2)

These points are drawn together in the next point – this is of key importance to this research – the highlighting is that of the author of this thesis:

“on test and evaluation, such activity should also be seen as an integral part of the acquisition process and again, should be undertaken from an early stage, not least because the evidence suggests that this helps to keep costs under control later in the process.” ([26] page 52 para 11.5 bullet 3)

This research is aimed at a way of delivering this.

2.1.1.4 *Luff Report*

In December 2011 Peter Luff, Minister for Defence Equipment, Support and Technology (see Appendix A Table 26 page 275) , issued a Green Paper (CM7989) [27] inviting interested parties to contribute to the White Paper “Security Through Technology” (CM 8278) [28]. Results of the consultation (CM 8277 [29]), acknowledging the responses, was issued with the White Paper [30] that describes the route to be taken following this consultation.

The White Paper opens with the attention grabbing statement that the previous proposals are not enough. The additional features offered that are of relevance to this research are:

- 1 Commercial off the shelf equipment is to be considered more than previously (*this research is based upon this premise*)
- 2 It is important that the Armed Forces and Security Forces learn from each other and share experiences. Presumably, due to the asymmetric

nature of some current conflicts which are close to civil disturbance issues traditionally covered by security forces. *(the communication capability, offered by this research, helps to address these issues in the area of use and requirements of sensor systems)*

The Luff Report also advocates sharing developments with friendly nations where possible. All of these points are taken into consideration in this research. The distributed aspects of this research output, coupled with visual communication capability, will help to facilitate this. More information is provided in Appendix B.4.

2.1.2 Summary of Organisational Evolution

The purpose of this short history is to draw attention to the long and complex history that applies to defence procurement. During the last 80-90 years a complex structure has grown that embodies the Civil Service way of doing things. Many of the 20,000+ people employed by this structure will have no experience of alternatives and will be concerned about the security of their employment. Attempts to change anything can expect to be met by DE&S personnel with anything from apathy to resistance that tends to revert to the current system, as identified by Gray ([31] page 32).

2.1.3 Key Organisational Factors

A premise of this research is that there is the will to improve the procurement system. Evidence in this section, Appendix A, Appendix B and summarised in Table 1, supports this premise. These and other points from later sections are collated in section 2.7. These points contribute to the conclusion that there is sufficient evidence that continuing and concluding this research could be of commercial value, as intended by an EngD research project.

However, there are factors outside the scope of this research that pose potential risks:

1. The will to improve the organisation – re the last 4 major reports needs to be sustained

2. There is likely to be resistance to change at the working level – re Gray and Levine reports
3. The proposed new structure is still emerging, but DE&S will report directly to their customers, the Chiefs of Staff who initiated the requirements that DE&S aim to meet. There is likely to be strong management monitoring of cash and performance re Gray and Levine reports. This will make funding change difficult to achieve. This can be countered by the potential saving of at least some of the 50-70% contingency budget (see section 2.3.1) being reduced by improvements offered here. If devolution of the DE&S function to a private organisation occurs, it will affect the way in which this research is implemented. It will not affect the arguments for its introduction. It may make it easier or more difficult; the current uncertainty makes it nearly impossible to plan.

These issues are identified from the following, and other, points in the reports. The reference numbers of these points relates to Table 1.

- | | |
|----------|---|
| Point 18 | DE&S 3-star structure should be rationalised and focussed upon a financial key role |
| Point 19 | Key engineering skills need to be added (<i>to PT activities</i>) |
| Point 20 | the lack of a culture that would support cyclic development, with incremental routes to improvement (<i>exists within DE&S</i>) |

Some important factors, extracted from the previous sections and their related Appendices, are shown in Table 1. The ‘Reference’ column (Ref) indicates the original source of the statement and the ‘Impact’ column indicates the related aspect of this research. The ‘FN’ references refer to footnotes. This research broadly divides into ‘technical’ and ‘organisational’. The ‘T’ and ‘O’ annotation in the ‘Impact’ column identifies which is the predominant factor for each original reference. Many of the issues are such that they affect both – such is the nature of real Engineering problems.

Table 1 – Organisational Issues Relevant to this Research

| # | Factor of Relevance to this Research | page | Ref | Impact |
|----|--|------|-------|--------|
| 1 | a small percentage saving in expenditure represents a significant value | 27 | [11] | T&O |
| 2 | specifications need to be analysed scientifically | 255 | [63] | T&O |
| 3 | awareness of value for money | 256 | | |
| 4 | method of comparison of alternative technical approaches | 256 | | |
| 5 | a method of comparing expected benefits and costs between options | 256 | | |
| 6 | Each Service competes for Treasury money | 257 | | |
| 7 | potential discontinuity of understanding between the two groups of stakeholders, military and scientific | 258 | FN 29 | O |
| 8 | The problem is to teach S&T personnel how to deal with the impact that their technologies have on cost | 258 | | |
| 9 | the situation of payment regardless of results is being challenged | 260 | [1,3] | O |
| 10 | The importance of research and development was highlighted together with the need for a strong supply chain with active academia and small-medium enterprises (SMEs) | 261 | | |
| 11 | there should be better grasp of through-life aspects of a project | 33 | FN 8 | T&O |
| 12 | sharing developments with friendly nations where possible | 37 | [15] | O |
| 13 | forces working to overcome the status quo | 31 | | |
| 14 | Simply put, many participants in the procurement system have a vested interest in optimistically misestimating the outcome. | 31 | | |
| 15 | collusion takes place between the same-service counterparts at these two levels to ensure that attractive (low-cost) estimates are provided | 264 | | |
| 16 | there is opportunity for clearer communication of pros and cons in comparing equipments and for estimating the life costs | 265 | | |
| 17 | There is serious discontinuity between these stakeholders (DE&S, Capability Heads and Service Chiefs) | 265 | | |
| 18 | DE&S 3-star structure should be rationalised and focussed upon a financial key role | 266 | | |
| 19 | Key engineering skills need to be added | 267 | | |

| # | Factor of Relevance to this Research | page | Ref | Impact |
|----|---|------|------|--------|
| 20 | the lack of a culture that would support cyclic development, with incremental routes to improvement | 267 | | |
| 21 | We must never send our soldiers, sailors and airmen into battle without the right equipment, the right training or the right support. | 268 | | |
| 22 | statement bounds the number of scenarios that must be met | 269 | | |
| 23 | We will aim to support the small and medium-sized enterprises that are a vital source of innovation and flexibility. | 272 | [12] | O |
| 24 | The strategic decisions will be handed down to each Chief of Staff, together with individual budgets for delivering their part of the strategy | 274 | | |
| 25 | The equipment and services required by the Chiefs will be delivered by DE&S (the ACQUIRE function) | 274 | | |
| 26 | scientific advice (Defence Business Services (DBS) Defence Infrastructure Organisation (DIO) and Dstl respectively) | 274 | | |
| 27 | The Chief of Defence Materiel (CDM) is responsible for all aspects of Acquisition | 275 | | |
| 28 | We recommend the Department should also consider how best to use this expertise (analysis) to draw upon relevant evidence, improve presentation, and clarify the issues for decision makers. | 35 | [13] | O&T |
| 29 | Science and technology advice should also be used more widely in support of decision-making across Defence. | 36 | | |
| 30 | on test and evaluation, such activity should also be seen as an integral part of the acquisition process and again, should be undertaken from an early stage, not least because the evidence suggests that this helps to keep costs under control later in the process. | 36 | | |
| 31 | all of the previous proposals are 'not enough' and that a 'new approach' is needed to buying and supporting defence and security equipment from industry | 276 | | |
| 32 | support for buying commercial-off-the shelf (COTS) equipment (rather than specifically designed or 'bespoke equipment) | 276 | [10] | O |

2.2 The Procurement Process

The procurement organisation is complex, as has been shown by section 2.1 and in Appendix A. The process used to procure equipment is a little simpler and is reviewed in this section. An understanding of the procurement process is necessary so that the proposed solution can be aligned with the process.

The process used by the MoD is defined on the MoD's Acquisition Operational Framework (AOF) website¹¹ as part of the Strategic Guide to Acquisition, previously this was achieved by an MoD Acquisition Framework Handbook [32]. The process has 6-stages defined by the acronym 'CADMID' (Concept, Analysis, Demonstration, Manufacture, In-Service and Disposal). The stages are sequential with major review points, also called 'Gates' between them.

Concept The concept stage results in a User Requirements Document (URD) defining what the user expects of the required system. The Capability Departments work with the Chiefs of Staff to evolve a concept to meet the military needs. The Departments will employ external analysis functions from Dstl, Niteworks or any other source that they feel is appropriate. A delivery team in DE&S is formed and any necessary further feasibility investigations are undertaken. A Through-Life Management Plan (TLMP) is developed, to define key activities and the necessary support functions to be delivered as part of the procurement. When it is thought that the necessary technology is sufficiently mature, an Initial Gate Business Plan is submitted to the Defence Board.

Analysis Assuming that the Defence Board approves the Initial Gate Plan, the analysis stage is initiated. This results in a Systems Requirement Document (SRD) being generated defining how the system will meet the needs of the URD, and a cross-reference between them is generated. Work is undertaken to identify the most cost-effective implementation technology

¹¹ The MoD website has controlled access at location <https://www.aof.mod.uk>

and method of procurement and this may involve iterations of the SRD so that risk is minimised. An Integrated Test Evaluation and Analysis Plan (ITEAP) is generated as a technical monitoring tool. A Main Gate Business Case is submitted to the Defence Board when these objectives are met.

‘C&A’ Objectives of this Research The aim of this research in the C and A stages of CADMID is to offer re-use of the techniques and findings during later stages of the CADMID cycle. To facilitate this, it is proposed that communication is focussed upon defining scenarios that demonstrate the capability gap to be filled. The various solution options explored during the analysis, (A) stage, can then be compared to provide a quantitative comparison. It is not suggested that this approach is totally new; the novelty is its re-use at later stages. It is proposed that the CA stages will be undertaken by a T&E team that will bridge the various stages, thereby retaining continuity and helping to avoid later misunderstandings about intent and scope. The ITEAP mechanism is potentially useful but needs to be generated by technical personnel rather than DE&S project management staff, as described in section 3.2.2.

Analysis, performed during the ‘A’ stage of CADMID, is undertaken by several organisations, further detail can be found in Appendix C. Customers for analysis are the Capability Departments and users are DE&S. It will be remembered that these organisations are geographically separated and they have different objectives. This research did not find significant evidence of connection between the organisations at their different lifecycle points.

In addition to Dstl, who undertake the more security and politically sensitive areas, the function is provided by private sector organisations that include Towers of Excellence and Niteworks. See the description in the footnote to section 2.1. More detail can be found in Appendices C.1 and C.2

Demonstration Assuming that the Main Gate Business Case is approved, the Demonstration phase starts. This stage generally involves Industry working under contract to develop the defined system. This stage is the main design and development stage for the implementation. This stage may

last many years and, for larger projects, can be subject to inclusion in the National Audit Office's annual Major Projects Reports – see section 2.3 on page 46 for further explanation of this and an analysis of their findings.

Manufacture The Manufacturing stage involves Industry in delivering the required system to the MoD within the agreed cost and timescale. Acceptance tests are performed to verify the specification (SRD) has been met and trials are often conducted to validate that the requirements (URD) have been met. Following Acceptance DE&S involvement reduces and the focus returns to the customer – the Service for which the system was built. However, DE&S will manage any post-delivery activities, including continued support and training.

'D&M' Objectives of this Research This research found that DE&S activities during the D and M stages are unpredictable as indicated in section 3.2.1. This research aims to build on the work done previously. It is proposed that the focus of the T&E work moves, with the T&E team, into industry for the D and M stages. The ITEAP will be a living 'document', illustrated by the executable scenarios that would be used to perform the tests for status monitoring and verification purposes.

In-Service DE&S provide support, training and maintenance facilities to the Service that is using the new equipment. They also support upgrades required during the life of the systems.

'I' Objectives of this Research Training requirements are currently met by the supply of a training system. A research objective is to re-use the T&E equipment for this purpose, thereby reducing the cost and time required to develop a bespoke training aid. Upgrades follow the CADMID process and the T&E facilities are aimed at supporting this re-run to extend the capabilities.

Disposal The safe, and environmentally friendly, disposal of the equipment at the end of its life

In the case of software procurement, the **‘Manufacture’** stage is replaced by **‘Migration’** during which the new service is introduced to replace the old and the term **‘Disposal’** is replaced by **‘Termination’** (to replace ‘CADMID’ with ‘CADMIT’) with the same intent.

2.2.1 CADMID in Practice

During the CADMID stages, DE&S provide the management stream to the activities. Technical input is provided to DE&S by Dstl and Industry as described in section 2.1. The stakeholders for each stage are shown, in a simplified form, in Table 2 where ‘Y’ shows a main involvement and ‘y’ a lesser involvement; braces show possible involvement, depending upon particular circumstances. For example, if a requirement is totally new (not based upon an existing equipment), DE&S are likely to be involved around the late A or start of D stages, whereas they would be involved earlier if an extension to an existing equipment were required.

| Stakeholder | C | A | D | M | I | D |
|---------------------------|----------|----------|----------|----------|----------|----------|
| DE&S (Project Management) | (Y) | (Y) | Y | Y | Y | Y |
| Capability Departments | Y | (Y) | | | | |
| Military user | Y | y | | | Y | |
| Dstl | Y | Y | | | | |
| Industry A | | y | | | | |
| Industry B | | | Y | Y | y | |

Table 2 – Stakeholder Involvement in the CADMID Cycle

There are two industrial involvements shown here as Industry A and Industry B. It is often the case that the early stage involvement is performed by different organisations than those wishing to bid for the main contract. In many cases, involvement in the early stages debars the organisation from bidding for subsequent work. The early work is, in some cases, provided by specialist companies (often consultancies) in the private sector. Niteworks, a collaboration of private companies (see sections C.2 and **3.3.4**), may also be involved in early stages and this allows a range of industrial organisations to participate under one umbrella contract. The table clearly indicates that there is project management continuity, provided by DE&S, but there is no technical continuity.

In fact, the project timescales are often such that people in the DE&S project management stream have career changes and move to different roles before a project is completed. The DE&S teams include military personnel who expect to move after 3-years as part of their career path. The Gray and Levine reports highlight this as a serious problem and propose extensions to the tenure of these personnel.

This research aims to provide a T&E tool that will help to bridge such discontinuities. It will incorporate the capability of supporting the training of new personnel who may question why a decision was made in the past. For example, this could be treated in the same way as a 'what-if' question of the type the research proposal aims to support during the CA stages of CADMID. Alternatively, traceability of decision-making would allow the capabilities before and after any change to be compared at any time during the lifecycle.

2.3 Project Performance Analysis

The annual Major Project Reports produced by the National Audit Office provide an insight into how well the current procurement process is working. Information from the year 2010 [33] provides recent information and falls into the period when reforms were taking place, Volumes 1 and 2 were used by this research for analysis. The projects were analysed by:

Cost Information – how well the project has performed vs. the expected cost when the order was placed (see Figure 1 and Appendix D Figure 48 and Figure 49).

Delay Information – an analysis of actual delivery (or planned delivery, if the project is not complete) vs. expected delivery when the order was placed

Performance Information – how well the DLODs (see Table 3) and KPMs are being met for each project.

The 9 DLODs (Acronym *TEPIDOIL + 1*)

1. **T** Training – having people known how to use it
 2. **E** Equipment – the equipment itself
 3. **P** Personnel – provision of appropriate numbers of suitable people
 4. **I** Information – understanding what the equipment will provide
 5. **D** Doctrine and Concepts – what it's likely to be used for
 6. **O** Organisation – support needed
 7. **I** Infrastructure – the necessary support buildings, platforms etc
 8. **L** Logistics – the ability to support and maintain it
- In addition, an overarching requirement:
9. **I** Interoperability – to meet the needs of an integrated system

Table 3 – The 9 DLODs

KPMs (Key Performance Measures) differ for each project and relate to the performance required of the delivered product or service.

Delivery Information – includes which prime contractors and PTs are involved with each project

Figure 1 shows the relationship between delays and overspends on all of the main projects. Note that project overspend is shown scaled so that a common axis could be used for timescale changes. The full-scale cost is £ (120 x 20) M.

Figure 1 clearly shows that most projects have (relatively) small over/under-spend. However, where there is over-spend it can be quite dramatic (bottom of figure). Furthermore, as would be expected, there is generally less delay on those projects with smaller over-spends (top 3/4 of figure).

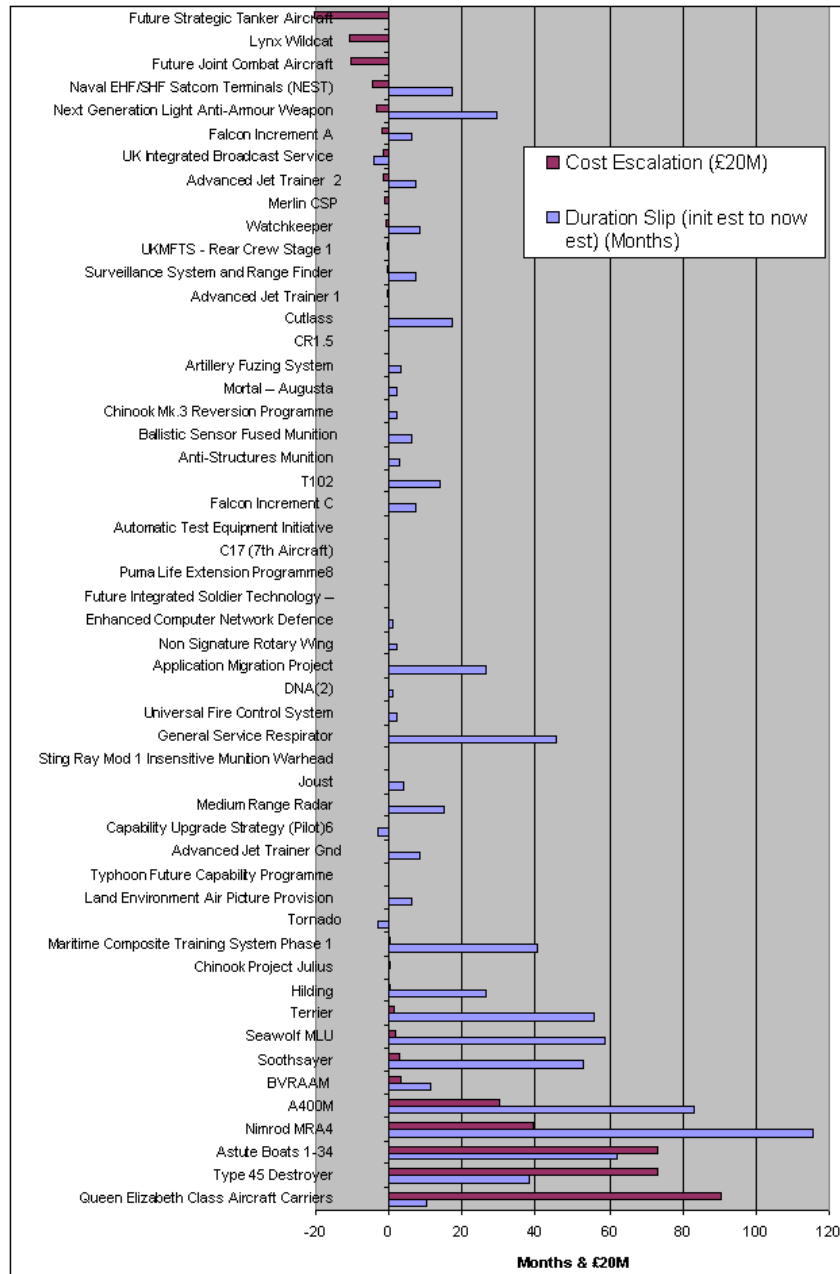

Figure 1 – Project Analysis Time and Cost

There are some projects where there is an under-spend but with delays (top 1/4 of figure). Project NEST (-£87M and + 17 months) and the Next Generation Light Anti-Armour Weapon (-£67M and + 29 months) are two of these. Because they are classed as small projects, further information is not published, so the cause cannot be positively identified.

It can be seen that the cost performance of projects is generally good, in fact the average overspend is 3.6% of expected cost. However, that does represent £5.5bn more than the expected bill for £154bn. The average timescale overshoot is 1¼ years, averages do not mean a great deal but it is difficult to obtain information for all projects. It can be appreciated that with this level of overspend and delay there is opportunity for this research to be considered if it can be shown to offer improvement.

2.3.1 Major Projects' Analysis

The main research is presented in Appendix D where the major projects reported by the NAO for 2010 [34] are analysed.

The pre-SMART sample size is too small for comparison of performance pre and post the introduction of SMART Acquisition (a 2005 initiative to improve delivery performance summarised in Appendix A, page 259). A comparison (Table 4) of the performance reported in the Gray report vs. the performance in 2010 suggests an improvement has resulted from SMART Acquisition.

| Issue | Gray | 2010 |
|-----------------------|-------------|------------------------|
| Average Time Overruns | 80% (5yrs) | 0 (max nearly 3 years) |
| Average Overspend | 40% (£300M) | 4% (£151M) |

Table 4 -- Changes in Performance since the Gray Report

The underlying statistics that existed in 2009, at the time of the Gray report [35], were significantly worse than is revealed by the 2010 figures [36]. Unfortunately, this improvement was not sustained in 2011 figures.

Appendix D.1 presents a time/delay analysis and Appendix D.2 presents an analysis of the state of equipment upon delivery in terms of its usefulness to the Service. These two data sets address the 'failing to produce' part of the charge that "the system is failing to produce the equipment we don't need" (The Gray Report [37] (p8)).

The 'equipment we don't need' part is accounted for by the fact that needs have moved-on since the equipment was defined, or that expected DLODS are missing, making the equipment unusable.

A more detailed look at The Major Projects Report 2010 [38] was taken to establish what might be achievable by identifying issues and their sensitivities in relation to overall performance. It was hypothesised that a problem was likely to be due to one or more of the following that are analysed:

1 Change of priorities

- a military
 - i change of threat/priority
- b political
 - i budgetary
 - ii policy changes

2 A misunderstanding in one or more areas

- a A technical issue that had been underestimated
- b A requirement that was not identified at an early stage
- c An emergent technical problem

These were analysed into 4-categories as described in Table 5, the descriptions are taken from actual issues identified in the NAO report [39].

| Programme Change (PC) | Technical Change (TC) | Friction - a 'knock-on' effect | Financial Adjustments (FA) |
|---|--|--|--|
| Changed delivery profile Unidentified variance Removing requirements for sub-systems Defer feature or reinstate it Contract date changed Change total number of deliverables Programme realism re-evaluated programme risks re-evaluated | Specification change Equipment added, deleted or modified Equipment features delayed or brought forward Modifications to special to type equipment Training needs added deleted or modified Changes to Spares and Deployment Kits | Changes in timing of expenditure Delay of programme Slip of payments and associated equipment Subsequent contract renegotiation due to changes Improved understanding - including adjustment for actual sunk costs | Variation in Cost of Capital Charge Changes to Cost of Capital Charge and Sunk Costs Correction of previous years treatment of deliveries Transfer from Resource/Capital Departmental Limit Exchange rate changes Changes in inflation rate |

Table 5 – Project Analysis Categories

Although not always simple to allocate a particular issue to just one category this was not serious problem. It was more significant that the accounting methods change between projects and during the life of a project making it near impossible to track the impact from the published results as changes are made. However, the key issues are the first two, programme and technical changes that generally lead to one or both of the other two 'friction' and financial adjustment.

There is an issue in the way that the budgets are set that is a little surprising if approaching this situation from a commercial perspective. When a project starts to slip, its contingency budget is brought into play and an item 'Risk Differential' holds the contingency money. So far, this is understandable; the amount is surprising. The amount of contingency money is (NAO definition):

“the most likely (50%) and the highest acceptable (not to exceed e.g. 80%) estimates at Main Gate”

This budget can be moved to offset the loss. It is not until the actual overspend exceeds the contingency fund that a loss is declared. The level of the contingency budget, given the amount of work done prior to the contract being let (Main Gate – generally the M stage of CADMID) is surprising. It might be expected that closer estimating and better control would reduce this to at least half.

2.3.2 Major Project Analysis Parameters

Table 6 shows some important parameters for the Main Projects of 2010, but there is less information for the rest of the projects.

In general, the selected Main Projects did not perform as well as the full project set. For example, whereas overspend for all projects was 12%, the main projects overspent by 27%; similarly there was a 22% delay compared to 15 % for the full set.

It can be seen that the DLOD performance showed that around 28% were

met whereas only 16% of Key Performance Measures were certain.

| All Projects | | Main Projects | |
|-------------------------|---------------|-------------------------|---------------|
| Expected Total Spend £M | 42,241 | Expected Total Spend £M | 37,462 |
| Forecast Spend £M | 47,419 | Forecast Spend £M | 47,419 |
| Overspend £M | 5,178 | Overspend £M | 9,957 |
| % overspend | 12 | % overspend | 27 |
| Average Overspend £M | 100 | Average Overspend £M | 664 |
| Delay (months) | 786 | Delay (months) | 332 |
| Average Delay (Months) | 15 | Average Delay (months) | 22 |
| | | DLOD met | 87 |
| | | DLOD at risk | 34 |
| | | KPM Met | 162 |
| | | KPM at risk or not met | 31 |
| | | Technical Change | £60 |
| | | Programme Change | £2,189 |
| | | Cost of Change | £5,384 |
| | | Financial Adjustment | -£330 |

Table 6 - Project Performance Data

The £5bn overall overspend shows that smaller projects have contributed + £4.9bn to offset the £9.9bn overspend on major projects. Furthermore, the overall delay of 1¼ years is worse on major projects that are likely to be delivered nearly two years late. From this, we can see that smaller projects are delivered more effectively than larger ones; this would also be an intuitive assumption.

This research work aims to bring some of the clarity with which smaller projects are run, to the running of larger projects. The mechanism for this is by providing a set of reference scenarios that offer ‘bite-sized’ methods of assessing projects’ capability.

2.3.2.1 Comparison by PT Groups

This research allocated main projects to land, sea or air groups and the cost/time overruns were normalised to the number of projects in each group.

The results are as shown in Table 7 where it can be seen that the naval projects show the worst performance. There are 3 major projects in this group, Astute (a submarine), QEII (an Aircraft Carrier) and T45 (a destroyer), which are all overspent and late.

There is insufficient evidence to be sure that the results are Service related because these three projects were amongst the largest in progress. The Nimrod MRA4 in the Air group was also late and overspent, so the issue may be related to project size rather than to the group running the projects. However, based upon these 3 naval projects, it can be seen that if there is a large Naval project the cost and time estimates need careful review and monitoring if they are to be delivered in time and to budget.

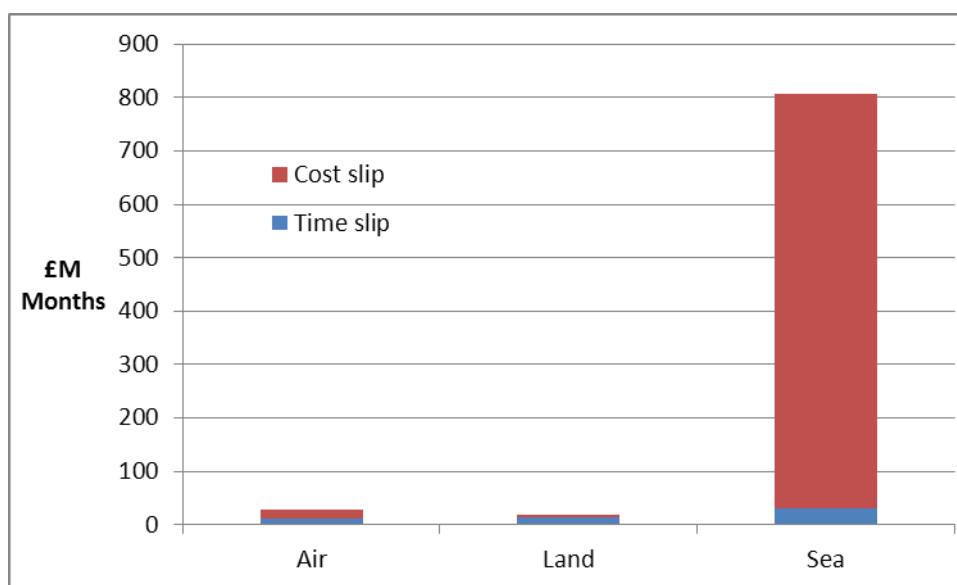

Table 7 – Cost and Time Variances per Service

2.3.3 Systemic or Other Reasons

The causes of the variances have logical and identifiable reason, although identification is not easy.

The hypothesis is that people take uninformed or untimely decisions, resulting in the variances that are reported. If this is correct, the underlying issue may be systemic or not.

Figure 2 shows detailed spend on each project in the categories previously defined. The graph also shows changes in numbers of equipment ordered during the time since Main Gate. It can be seen that the number of Typhoon aircraft has been reduced by 72. The Typhoon project has a very high frictional cost and the financial cost¹² (due to currency exchange rates) has contributed to overspend. Although the programme decisions reduced the short-term cost, the frictional and financial cost far outweighed the saving. It can be seen that technical issues played only a small, but positive, part by reducing overall escalation. The aircraft carriers' analysis shows that change in numbers ordered is not the only cause that increased cost, the carriers had a cost increase anyway associated with programme decisions.

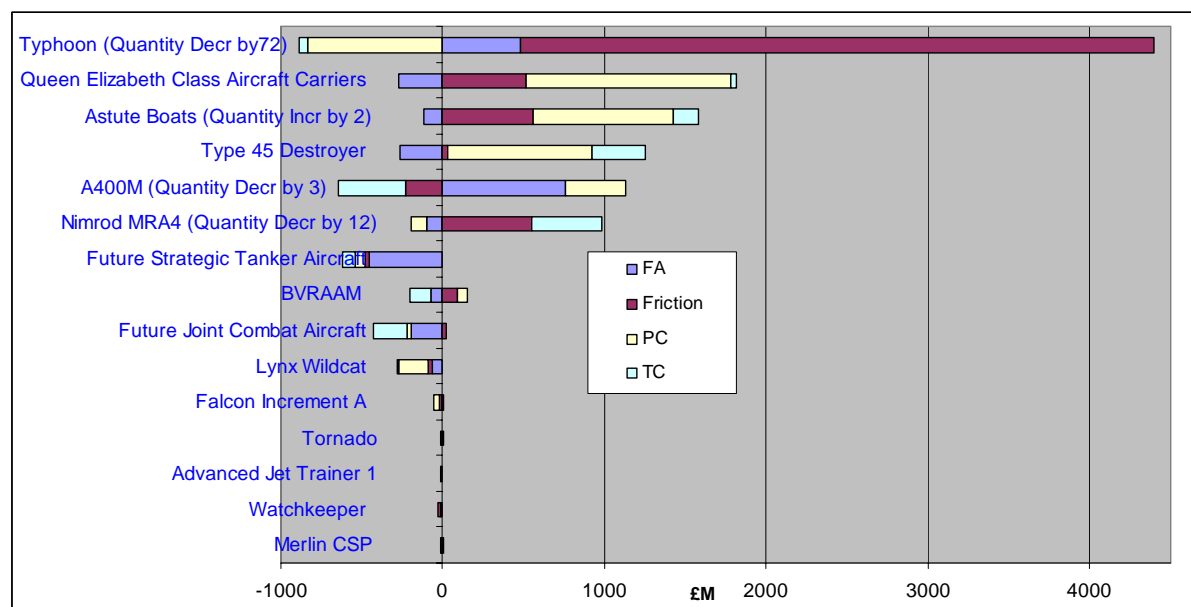

Figure 2 – Detailed Spend vs. Projects

¹² See Table 5 and Appendix D for more information and definitions of terms.

There is no significant correlation (less than 50%) between overspends in the categories selected. It can be assumed, because of the nature of the Civil Service, that the procedures will have been applied in cases where they were identified as being appropriate. Lack of correlation suggests that the reasons for the variances are not caused by applying procedures. It does not extend to showing that procedures are missing, flawed or applied in an inconsistent way. If there are lessons to be learned, they must be by individually examining each project in more detail to identify the cause. One issue that does seem to be valid, from a commonsense point of view, is that changing the number of items ordered will have an adverse affect upon the cost. It is substantiated by the projects reviewed i.e. it is a bad thing to do.

A comparative investigation of the projects on the upper and lower parts of Figure 2 would be helpful to identify what lessons might be learned. Unfortunately, there is insufficient public data available to make this practical. However, another way of approaching the issues provided some insight.

2.4 An Inside View – Interview Results

A false impression of delivery efficiency can be achieved if equipment performance is significantly degraded, so that a project can be delivered on time and to budget. During interviews with a mix of DE&S Service personnel and civilians in DES Ships at Abbey Wood in 2011¹³, the following issues were reported as techniques to maintain budgets and delivery times:

- It is not unknown to buy ‘placeholders’ for sub-systems that are really needed, knowing that they won’t perform as required but can be replaced later. The effect is reduced operational capability that can lead to increased exposure to danger.
- The training DLOD is sometimes reduced to the point that it is ineffective and the budget re-allocated to other things to achieve delivery. Consequently, users cannot operate the equipment effectively and this reduces their capability as well as costing time to resolve.

¹³ Undertaken as part of a contract let by CAP JTES to a report upon the use of Simulation for Test and Evaluation across 4 DE&S PTs, by the author and other representatives from a consortium of organisations.

- Delivery is sometimes accepted with some sub-systems being delivered while ‘shake-down’ trials and training are taking place. This requires equipment downtime during a period where that can be very inconvenient. Service personnel are ‘stood-down’ during these periods, this is expensive and time wasting
- Contracts can be drawn up with industry to deliver equipment with major sub-systems missing. This can happen if there are several suppliers whose delivery times do not align. Deliveries are then ‘on time’ and ‘complete’ but it does not result in operational equipment. The effect is that the main equipment is not fully operational but must be maintained until the missing parts are available.

When asked about cost implications of this, there was no clear way to estimate the cost of such partial delivery practices. However, two pointers were suggested:

- What is the interest and depreciation on the cost of equipments over the period they cannot be used?
- What is the cost of supporting the Service personnel who cannot be deployed with their equipment as expected?

One interviewee summed this up by saying that the policy of ‘spend-to-save’ (meaning that money spent early will save money later), turns into saving an amount now to spend much more later, or ‘save to spend’ is rife. This issue was reported in the NAO Report on the MoD’s activities [40] p22 sect 66

Decisions to increase overall costs in order to achieve short-term savings are often made with the expectation that future spending increases would cover the future increases in costs.

2.4.1 Enterprise Issues

There remains the question about what actually needs to change, in the detail of the procurement process, if improvements are to be realised. It was recognised by the interviewees that there needs to be ‘Enterprise’ and cultural changes in the procurement chain that are difficult to achieve.

Further discussion was held with an ex-Air Force Officer (name withheld) who has worked in DE&S. Since leaving the Service, he has acted as a consultant to the Air Warfare Centre whilst employed by a private company. This exposed other difficulties that can be experienced. Namely, there are people in the procurement chain who are aware that the system is flawed, but feel unable to change it:

“I have worked in the procurement chain and have been tasked with a work-package that I knew would not deliver what was needed at the frontline but it was my job to provide what I was tasked to provide.”

This direct evidence supports the Gray report finding that a ‘team spirit’ prevents individuals objecting too vehemently to the current system [41] page 44.

The risk is of being characterised as an unhelpful person, “not a team player”, or obstructive and negative

An interview with the Commanding Officer (an Air Commodore) of the Air Warfare Centre (RAF Waddington) provided the insight that there is a perception that the objective of DE&S is to provide equipment that is ‘safe’. The assessment of the deliverable to increase capability is not done until the equipment is received by the Air Warfare Centre (in the case of airborne equipment). A similar view was expressed by the Naval Commander responsible for the navy’s Shore Integration Facility (SIF – Portsdown Hill Hampshire).

This indicates that there is a need for improving capability assessment, such as proposed here, to the performance measurement tools available to DE&S for use during the pre-delivery stages of CADMID.

2.4.2 Relevance of Project Performance to this Research

Important factors, relating to this research, extracted from the performance analysis sections are shown in Table 8. For consistency with Table 1, all of these issues were extracted from the 2010 NAO report on MoD's Major projects [42]. They indicate that technical change is required and so they influence the technical aspects of this research. However, the technical change itself would be insufficient and, as this research shows – substantiated by the 4 reports reviewed previously, corresponding organisational change is required.

Table 8 – Project Performance Factors Relevant to this Research

| # | Factor of Relevance to this Research | Page (& [11]) |
|----|---|---------------|
| 1 | the 'prime-mover' issues are likely to be one or both of Programme or Technical Changes | 283 |
| 2 | it is not always simple to allocate a particular issue to a single category | 283 |
| 3 | financial control of projects and balancing budgets has been, and still is, a main focus of defence procurement | 284 |
| 4 | It is not until the actual overspend exceeds the contingency fund that a loss is declared | 284 |
| 5 | the effect of any changes increases the overall costs, even though the purpose of introducing the change is often to reduce short-term spending | 285 |
| 6 | the DLOD performance showed that around 28% were met whereas only 16% of Key Performance Measures were certain | 50 |
| 7 | the naval projects show the worst performance | 52 |
| 8 | There is insufficient evidence to be sure that the results are Service related because these three projects were amongst the largest in progress | 52 |
| 9 | if there is a large Naval project the cost and time estimates need careful review and monitoring if they are to be delivered in time and to budget | 52 |
| 12 | The hypothesis is that people take uninformed or untimely decisions | 53 |
| 13 | There is no significant correlation (less than 50%) between overspends in the categories selected | 54 |
| 14 | Lack of correlation suggests that the reasons for the variances are not caused by applying procedures. It does not extend to showing that procedures are missing, flawed or applied in an inconsistent way. | 54 |

| # | Factor of Relevance to this Research | Page (& [11]) |
|----|--|---------------|
| 15 | changing the number of items ordered will have an adverse affect upon the cost | 54 |
| 16 | A false impression of delivery efficiency can be achieved if equipment performance is significantly degraded, so that a project can be delivered on time and to budget | 54 |
| 17 | techniques to maintain budgets and delivery times | 54 |
| 18 | no clear way to estimate the cost of such partial delivery practices | 55 |
| 19 | 'save to spend' is rife | 55 |
| 20 | there needs to be 'Enterprise' and cultural changes in the procurement chain that are difficult to achieve | 55 |
| 21 | there are people in the procurement chain who are aware that the system is flawed, but feel unable to change it | 56 |
| 22 | direct evidence supports the Gray report finding that a 'team spirit' prevents individuals objecting too vehemently to the current system | 56 |

There is much confusing data in the raw analysis of the four Government reports and NAO reports. The rest of this section draws these together into 3 categories

1. The **outcomes** of the current system (that this research seeks to change)
2. The likely **causes** of the outcomes being what they are (indicating what changes might be needed)
3. The **objectives** shared between the reports and this research, that it is required to meet

These are collated, in section 2.7, with other points from this Chapter.

Outcomes that have been produced by current practice:

- Point 4 It is not until the actual overspend exceeds the contingency fund that a loss is declared (***This means that many projects exceed their expected budget by over 70%.*** *(This is a large budget, some of which could be diverted to reducing the risk of overspend and delays occurring)*)
- Point 5 the effect of any changes increases the overall costs even though the purpose of introducing the change is often to reduce short-term spending

- Point 6 the DLOD performance showed that around 28% were met whereas only 16% of Key Performance Measures were certain
- Point 7 the Naval projects show the worst performance (*see the next point*)
- Point 8 There is insufficient evidence to be sure that the results are Service related because these three projects were amongst the largest in progress
- Point 13 There is no significant correlation (less than 50%) between overspends in the categories selected
- Point 14 Lack of correlation suggests that the reasons for the variances are not caused by applying procedures. It does not extend to showing that procedures are missing, flawed or applied in an inconsistent way.
- Point 16 A false impression of delivery efficiency can be achieved if equipment performance is significantly degraded, so that a project can be delivered on time and to budget
- Point 19 'save to spend' is rife
- Point 21 there are people in the procurement chain who are aware that the system is flawed, but feel unable to change it

These undesirable outcomes cost money, some of which can be saved by this research offering a way to reduce the incidence of the causes.

Causes – attention is drawn to the possibility of some of these issues being artefacts, as described in the previous text.

- Point 1 the 'prime-mover' issues are likely to be one or both of Programme or Technical Changes
- Point 2 it is not always simple to allocate a particular issue to a single category
- Point 9 if there is a large Naval project the cost and time estimates need careful review and monitoring if they are to be delivered in time and to budget (*in the data analysed, the largest projects were in the Naval group so this is not an indication that the problems are*)
- Point 12 The hypothesis is that people take uninformed or untimely decisions
- Point 15 Changing the number of items ordered will have an adverse affect upon the cost
- Point 20 there needs to be 'Enterprise' and cultural changes in the procurement chain that are difficult to achieve

The summary of causes, from the analysis of results and direct evidence from interviews, points to the following:

- The procedural guidelines being followed with reasonable rigour (because there are checks and balanced in place to monitor this)

- The guidelines not penetrating to the depth needed for issues to be adequately and effectively addressed (analysis of guidelines for controlling a project through its lifecycle is presented in section 3.2.1 and for producing an Integrated Test and Evaluation Plan is presented in section 3.2.2).

Objectives shared between the reports and this research

- Point 3 financial control of projects and balancing budgets has been, and still is, a main focus of defence procurement – the objective to achieve better control is shared
- Point 17 techniques to maintain budgets and delivery times are under review – this research proposes a technique to achieve this
- Point 18 no clear way to estimate the cost of such practices (*time overrun and delivery with DLODS missing*) – rationalising the organisational and technical aspects, as proposed by this research would achieve this and so assist with achieving the previous two objectives

The causes are deep rooted in the culture, a problem made worse by there being no effective structure to deal with the issues. This may change as part of the current reforms.

2.5 Additional Motivation to Improve the Procurement Process

Recent and current conflicts, to which the UK Government has committed troops, are ‘discretionary’ involvements. The political decision is to join with partners to fight the threat at its roots, rather than each partner having to remove the symptoms from their doorsteps. The homelands are not directly threatened; the battles are over hearts and minds not territory. The general populace (the voters) are not in fear of invasion or threat to their lives or homes in the sense that existed in the first and second world wars. This affects the acceptable level of risk to troops; it reduces the acceptable level.

The UK Government need to be seen to be providing adequate protection to the troops because military deaths are much less acceptable than in a full-scale conflict. This concept is encapsulated in ‘Winning the Peace’ the 15th Annual Strategy Conference in Pennsylvania in 2004 [43]

With little doubt, three of the most pressing and frequent problems grappled with in Western defense and geostrategic literature over the past 20-30 years have been how to fight asymmetric wars, how to win the hearts and minds of an enemy populace, and how to terminate wars and devise exit strategies successfully.

This has two knock-on effects relevant to this research. Project timescales need to be reduced so that effective and up-to-date equipments are made available as technology moves on. Falling at the final delivery hurdle is not acceptable. Surveillance equipments, that use the sensors considered here, are much more important than offensive weapons, the last resort. Furthermore they need to be improved, so that, for example, fleeing refugees on tractors and buses are not reported as troop convoys and attacked – sadly, an event that occurred in Bosnia in 1999 [44].

“...the AFP correspondent in Kosovo, Aleksandar Mitic, the correspondent of the daily Los Angeles Times, Paul Watson, and two Greek television crews were able to go to the scene of the bombing. They found scenes of disaster, with "bodies charred or blown to

pieces, tractors reduced to twisted wreckage and houses in ruins." According to Mitic's report, two convoys, one to the north and one to the south of the town of Djakovica, were the target of the bombings. He quoted one refugee as saying the groups had been bombed three or four times, "the planes circling overhead as if they were following us". Alexandre Levy Europe desk researcher Reporters sans frontiers 1999 [44]

The main customer in the UK (the MoD) might be expected to be the repository for lessons learned from experiences. Such experiences need to be fed back into the test and verification thinking. This could be achieved by including such requirements in future specifications, to include testing for previously identified failures.

It is not an issue specific to a particular supplier and an outsider might find the current method of achieving this learning a little difficult to identify; it seems to be a matter for individual memory, so this is no more than 20 years at the most. This is beyond the scope of this research but it is identified as an area for further work. Given the approach proposed by this research, a possible solution might be to include scenarios that show the errors on existing equipment. Running these as regression tests on new equipment would be a way to check if the issues had been overcome.

2.5.1 Relevance of Motivation

This evidence supports the assumption that, at least at some levels, there is a strong will to change the existing situation. It is important to be certain that, in an arena where political rhetoric is commonplace, there is a solid basis for requiring change.

2.6 Summary of Procurement Process

The procurement process encompasses more than just placing orders for equipment. The main relationships between the procurement activities can be seen from Figure 3. They include the policy-making and delivery mechanisms (the blue boxes), together with their supporting functions (grey boxes).

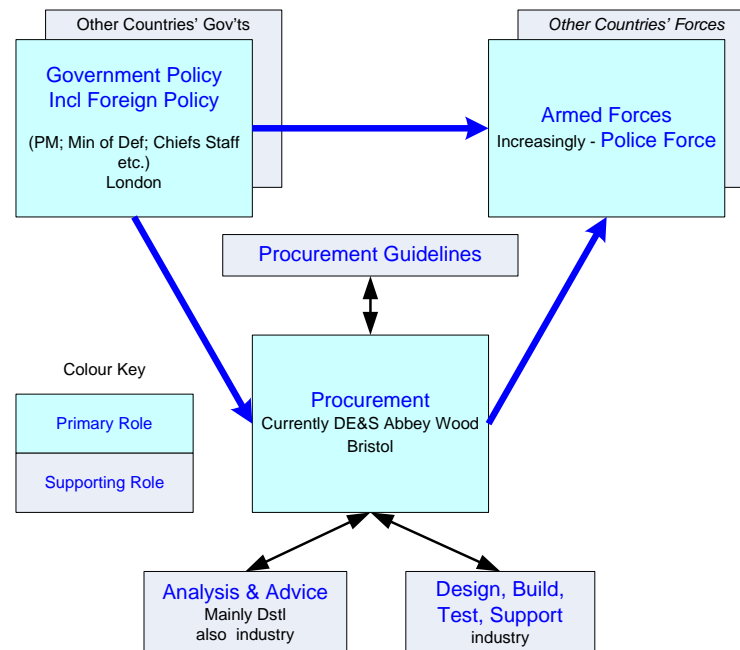

Figure 3 - Procurement Relationships

The historical background (section 2.1 and Appendix A) shows how the system evolved to its present form, and that there have been many attempts at improving its efficiency. Technically, analysis has grown into the current practices (section 2.2) that include the CADMID and ITEAP processes (see section 3.2.2). Commercially, the SMART initiative has grown into guidance for PTs for each aspect of the CADMID cycle as presented by the AOF website.

Still this is not producing the required results, the NAO Major Project Reports (the year 2010 was analysed in detail – section 2.3) consistently shows overspend and delays on many projects. This problem is compounded by issues with the Procurement system that Gray and Levine are addressing; several of these were confirmed by first-hand experience as discussed in section 2.4.

2.7 Commercial Concerns

The following questions summarise issues of commercial concern to a company wishing to contribute to the improvement of the MoD's procurement system. This is particularly germane to a smaller company, specifically the sponsoring company, for which the proportional investment, in relation to turnover, is likely to be higher than for a major company.

Q1: Do the MoD and Politicians really want to introduce change?

Q2: What will happen if there is no change?

Q3: Are the MoD prepared to consider an SME in this role?

Q4: Who are the key players that need to 'buy-in' to this approach?

Q5: Does the MoD want what we are offering?

Q6: Do any issues have an overriding influence on outcomes?

These are addressed in the following sections that refer to previous research, sections 2 and 3, plus their associated Appendices A and B.

Each of the sections in this chapter has a summary that refers to text in the sections. The following tables use this as evidence to ascertain the value that might be expected from this research.

Q1: Do the MoD and Politicians really want to introduce change?

All attempts at change over the years have been well intended. Some, particularly those most affected, claim that change is itself part of the problem and stability is what is required. However, there is simple logic in the argument that the MoD is too large, too expensive and too slow to meet modern needs. This was argued in the Gray Report and its author has since been appointed to Chief of Defence Materiel, in charge of Procurement at Abbey Wood. Furthermore, it was announced in early 2012 that the budget had been balanced¹⁴, although there was considerable political cost in terms

¹⁴ Defence Secretary Philip Hammond tells MPs that the Ministry of Defence has balanced its budget for the first time in about a decade BBC News 14th may 2012 <http://www.bbc.co.uk/news/uk-politics-18054731>

of consequential redundancies in the Services during a conflict. Attention is drawn to the following points in Table 9 that present the arguments.

Table 9 –Is Change Really Required?

| For | Against |
|---|--|
| 1. a small percentage saving in expenditure represents a significant value – and so the potential savings are worth making. <i>(Table 1 Point 1 (p 39))</i> | 1. The will to improve the organisation – re the last 4 major reports, persists for long enough for the changes to be effective |
| 2. awareness of value for money is evident in the information available and White Papers produced. <i>(Table 1 Point 3 (p 39))</i> | |
| 3. the situation of payment regardless of results is being challenged – this research is working towards a quantitative measurement system. <i>(Table 1 Point 9 (p 39))</i> | 2. The proposed new structure is still emerging but DE&S will report directly to their customers, the Chiefs of Staff who initiated the requirements DE&S aim to meet. There is likely to be strong management monitoring of cash and performance re Gray and Levine reports. First-hand contact with one Chief of Staff during this research period revealed a very positive will to ensure that improvement is achieved. |
| 4. We must never send our soldiers, sailors and airmen into battle without the right equipment, the right training or the right support. <i>(Table 1 Point 21 (p 39))</i> | |
| 5. all of the previous proposals are ‘not enough’ and that a ‘new approach’ is needed to buying and supporting defence and security equipment from industry. <i>(Table 1 Point 31 (p 39))</i> | 3. The result of the struggle between these 2 views will be critical to the outcome of this research |
| 6. There is direct evidence from people engaged in day-day activities to confirm their support for change. <i>(Section 2.4 (p 54))</i> | |
| 7. There is political motivation due to the desire to minimise collateral damage during conflicts <i>(Section 2.5 (p 61))</i> | 4. There is likely to be resistance to change – re Gray and Levine reports |

Q2: what will happen if there is no change?

Without change, the required benefits (primarily improved delivery of equipment to the armed forces at controlled cost and with shorter timescales) will remain at its present level of performance. This is shown by the NAO annual performance reports of MoD procurement to be less than perfect. Some of the effects are listed below:

1. It is not until the actual overspend exceeds the contingency fund that a loss is declared. The contingency fund is large and smaller projects are delivered well within it. See note 1. *(Table 8 Point 4 (p 57))*
2. the effect of any changes increases the overall costs, even though the purpose of introducing the change is often to reduce short-term spending. See note 1. *(Table 8 Point 5 (p 57))*
3. the DLOD performance showed that around 28% were met whereas only 16% of Key Performance Measures were certain. See note 1 *(Table 8 Point 6 (p 57))*
4. There is no significant correlation (less than 50%) between overspends in the categories selected. *(Table 8 Point 13 (p 57))*
5. A false impression of delivery efficiency can be achieved if equipment performance is significantly degraded, so that a project can be delivered on time and to budget. See note 1. *(Table 8 Point 16 (p 57))*
6. 'save to spend' is rife - See note 1. *(Table 8 Point 19 (p 57))*
7. there are people in the procurement chain who are aware that the system is flawed, but feel unable to change it See note 1. *(Table 8 Point 21 (p 57))*
8. direct evidence supports the Gray report finding that a 'team spirit' prevents individuals objecting too vehemently to the current system. See note 1. *(Table 8 Point 22 (p 57))*

Note 1: quantitative monitoring (as proposed) can help to offset this.

Q3: Are the MoD prepared to consider an SME in this role?

Section 4.1 proposes a way that small companies can bridge the MoD Procurement and prime contractors' activities, in a way that offers benefit to both. The proposal calls for design and development to be separated from test and evaluation functions, in line with Systems Engineering good practice, the first to be undertaken by prime contractors and the second to be undertaken by SMEs. It is to be expected that the Prime Contractors will resist any change to their work-share, especially in a market that is shrinking. The implementation of this will be a test of the MoD's claims of openness in considering change, their claims are summarised in Table 10.

| For | Against |
|---|---|
| 1. The importance of research and development was highlighted together with the need for a strong supply chain with active academia and small-medium enterprises (SMEs). (<i>Table 1 Point 10 (p 39)</i>) | 1. It is not substantiated in this research, other than by experience in this field, but it is likely that existing beneficiaries in this role will object. |
| 2. We will aim to support the small and medium-sized enterprises that are a vital source of innovation and flexibility. (<i>Table 1 Point 23 (p 39)</i>) | |
| 3. The Departments will employ external analysis functions from Dstl, Niteworks or any other source that they feel is appropriate. (<i>Section 2.2 (p 41)</i>) | |
| 4. An Integrated Test Evaluation and Analysis Plan (ITEAP) is generated as a technical monitoring tool. (<i>Section 2.2 (p 42)</i>) | |
| 5. It is often the case that the early stage involvement is performed by different organisations than those wishing to bid for the main contract. (<i>Section 2.2.1 (p 44)</i>) | |
| 6. Analysis, performed during the 'A' stage of CADMID, is undertaken by several organisations. (<i>Section 2.2 (p 42)</i>) | |

Table 10 - Would the MoD Consider an SME in this Role?

Q4: Who are the key players that need to ‘buy-in’?

The main stakeholders are those affected by the proposed change, either because they are decision makers or participants in the activities. Clearly, they include the Chiefs of Staff and DE&S Management.

At a lower level, ITEAP is a key area of current interest to the MoD. There is inadequate infrastructure to support these plans when they do exist because DE&S do not provide technical roles. A part of this is providing more influence over the ‘M’ stage of the CADMID cycle for which no guidance currently exists – see section 3.2.1.

The Interview comments (section 2.4) suggest there may be more support from inside the organisation than might be expected. It is likely, due to career considerations, that progress will be needed at the Enterprise level before this support materialises. Those people who can affect the implementation of this research include those identified below:

1. The equipment and services required by the Chiefs will be delivered by DE&S (the ACQUIRE function) – the responsible body is clearly defined. *(Table 1 Point 25 (p 39))*
2. scientific advice (Defence Business Services (DBS) Defence Infrastructure Organisation (DIO) and Dstl respectively) – provide advice but without a coordinated approach. *Table 1 Point 26. (p 39))*
3. The process has 6-stages defined by the acronym ‘CADMID’ (Concept, Analysis, Demonstration, Manufacture, In-Service and Disposal). *(Section 2.2 (p 41))*
4. DE&S provide the management stream to the activities. *(Section 2.2.1 (p 44))*
5. The Departments will employ external analysis functions from Dstl, Niteworks or any other source that they feel is appropriate. *(Section 2.2 (p 41))*
6. An Integrated Test Evaluation and Analysis Plan (ITEAP) is generated as a technical monitoring tool. *(Section 2.2 (p 42))*
7. It is often the case that the early stage involvement is performed by different organisations than those wishing to bid for the main contract. *(Section 2.2.1 (p 44))*
8. there is project management continuity, provided by DE&S, but there is no technical continuity. *(Section 2.2.1 (p 44))*
9. the project timescales are often such that people in the DE&S project management stream have career changes and move to different roles. *(Section 2.2.1 (p 45))*
10. Analysis, performed during the ‘A’ stage of CADMID, is undertaken by several organisations. *(Section 2.2 (p 42))*

Q5: Does the MoD want what we are offering?

Comparing what is required by the MoD and what this research could offer provides a measure of how accurately the problem is identified and how well the proposed solution fits. Section 2.1 offers evidence that the MoD is moving towards the type of solution being offered. The correlation between the research offering and required features is indicated in Table 11.

Table 11 – Correlation between Perceived Needs and this Research

| Feature | Offered by this research? |
|--|--|
| 1. specifications need to be analysed scientifically. (Table 1 Point 2 (p 39)) | Yes – key feature |
| 2. A method of comparison of alternative technical approaches is required. (Table 1 Point 4 (p 39)) | Yes – key feature |
| 3. A method of comparing expected benefits and costs between options is required. (Table 1 Point 5 (p 39)) | Yes – by supporting technical benefit analysis |
| 4. statement bounds the number of scenarios that must be met. (Table 1 Point 22 (p 39)) | Yes- this research utilises scenarios |
| 5. support for buying commercial-off-the shelf (COTS) equipment (rather than specifically designed or 'bespoke equipment). (Table 1 Point 32 (p 39)) | Yes – by supporting technical benefit analysis |
| 6. Each Service competes for Treasury money. (Table 1 Point 6 (p 39)) | Helps assessment - by offering a quantitative way to evaluate claims and stratify allocation of funds towards sensor types rather than users of them |
| 7. potential discontinuity of understanding between the two groups of stakeholders, military and scientific, this research aims to bridge these gaps. (Table 1 Point 7 (p 39)) | Yes – by providing an improved method of communication |
| 8. The problem is to teach S&T personnel how to deal with the impact that their technologies have on cost. (Table 1 Point 8) (p 39)) | Yes - by simplifying technical assessment and communication with Service personnel |
| 9. there should be better grasp of through-life aspects of a project. (Section 2.1.1.1 Rec 4 (p 33)) | Yes – key feature |
| 10. sharing developments with friendly nations where possible this will need good communication. (Section 2.1.1.4 (p 37)) | Yes – by providing an improved method of communication |
| 11. forces working to overcome the status quo – possibly because they have not seen the benefits of change. (Table 1 Point 13 (p 39)) | Yes – by providing an improved method of communication |

| Feature | Offered by this research? |
|---|---|
| 12. Simply put, many participants in the procurement system have a vested interest in optimistically misestimating the outcome. (Table 1 Point 14 (p 39)) | Yes – by providing an improved method of communication |
| 13. collusion takes place between the same-service counterparts at these two levels to ensure that attractive (low-cost) estimates are provided. (Table 1 Point 15 (p 39)) | Yes – by providing an improved method of communication |
| 14. there is opportunity for clearer communication of pros and cons in comparing equipments and for estimating the life costs. (Table 1 Point 16 (p 39)) | Yes – key feature |
| 15. There is serious discontinuity between these stakeholders (DE&S, Capability Heads and Service Chiefs). (Table 1 Point 17 (p 39)) | Yes – through-life is a key point |
| 16. The strategic decisions will be handed down to each Chief of Staff, together with individual budgets for delivering their part of the strategy. (Table 1 Point 24 (p 39)) | Yes - this forms the basis of what needs to be communicated |
| 17. Uncoordinated scientific advice (Defence Business Services (DBS) Defence Infrastructure Organisation (DIO) and Dstl respectively). (Table 1 Point 26 (p 39)) | Yes - by a coordinated approach to the advice |
| 18. The Chief of Defence Materiel (CDM) is responsible for all aspects of Acquisition – clear and unambiguous messages at this level are essential. (Table 1 Point 27 (p 39)) | Yes – by building-in monitoring criteria |
| 19. We recommend the Department should also consider how best to use this expertise (analysis) to draw upon relevant evidence, improve presentation, and clarify the issues for decision makers. (Table 1 Point 28 (p 39)) | Yes – key feature |
| 20. Science and technology advice should also be used more widely in support of decision-making across Defence. (Table 1 Point 29 (p 39)) | Yes - by a stakeholder-coordinated approach |
| 21. on test and evaluation, such activity should also be seen as an integral part of the acquisition process and again, should be undertaken from an early stage, not least because the evidence suggests that this helps to keep costs under control later in the process. (Table 1 Point 30 (p 39)) | Yes – this is key to this research proposal |
| 22. there is project management continuity, provided by DE&S, but there is no technical continuity. (Section 2.2.1 (p 44)) | Yes – technical continuity is a key feature |

| Feature | Offered by this research? |
|---|--|
| 23.the project timescales are often such that people in the DE&S project management stream have career changes and move to different roles. (<i>Section 2.2.1 (p 45)</i>) | Yes – the approach simplifies monitoring and record keeping by making results inherently recorded |
| 24.An Integrated Test Evaluation and Analysis Plan (ITEAP) is generated as a technical monitoring tool. (<i>Section 2.2 (p 42)</i>) | Yes – the scenario approach greatly simplifies the generation of an ITEAP by relating performance to scenarios |
| 25.techniques to maintain budgets and delivery times <i>Table 8 Point 17 (p 57)</i> | Yes – with fewer potential discontinuities this becomes easier |
| 26.no clear way to estimate the cost of such partial delivery practices. (<i>Table 8 Point 18 (p 57)</i>) | Yes – with fewer potential discontinuities this becomes easier |

Q6: Do any issues have an overriding influence on outcomes?

The most significant influencer is likely to be the strength of intent to carry through the changes proposed by Gray and Levene given the establishment's likely resistance to change. The factors that will counter these efforts are described in the Gray report and analysed in section 2.1. Attention is drawn to the following points that need to be kept under consideration as implementation proceeds.

1. the 'prime-mover' issues are likely to be one or both of Programme or Technical Changes. (*Table 8 Point 1 (p 57)*)
2. it is not always simple to allocate a particular issue to a single category. (*Table 8 Point 2 (p 57)*)
3. The hypothesis is that people take uninformed or untimely decisions. (*Table 8 Point 12 (p 57)*)
4. changing the number of items ordered will have an adverse affect upon the cost. (*Table 8 Point 15 (p 57)*)
5. there needs to be 'Enterprise' and cultural changes in the procurement chain that are difficult to achieve. (*Table 8 Point 20 (p 57)*)

2.7.1 Commercial Summary

The evidence above indicates that there is a good chance that the research is relevant to the MoD's needs. It integrates the lifecycle T&E process and offers a good resolution of quantitative status monitoring. All of these aspects can contribute positively to the issues above. The research proposal offers the Enterprise and technical potential opportunity to address these issues more effectively than is currently the case.

The historical perspective shows that introducing change is not an easy task because resistance to change is endemic.

The undesirable outcomes cost additional money, some of which can be saved because this research offers a way to reduce the incidence of the causes.

There must always be concern about the strength of political statements. However, the following lend weight to the assumption of genuine intent to improve the procurement process and get better value for money

1. The current financial conditions demands it – there is little spare money
2. There is public demand (i.e. Voters) for improved efficiency and less waste
3. The appointment of Bernard Gray with backing from Lord Levene
4. Balancing the MoD's budget (at a political cost)

3 Current State of the Art

The previous chapter established a need to improve the procurement of military equipment, to achieve better value for money. There are 4 main commercial instruments used by the MoD for procurement and these are reviewed in this chapter.

The first two sections are of general application; from there on the research is more specific. The thesis addresses the industry perspective on specifying and measuring radar performance. This focuses the issues specifically to radar sensors, although they represent only one aspect of this multi-sensor approach. The tools available are surveyed and ‘best practice’ is identified in those areas reviewed. This chapter’s content is depicted in Figure 4.

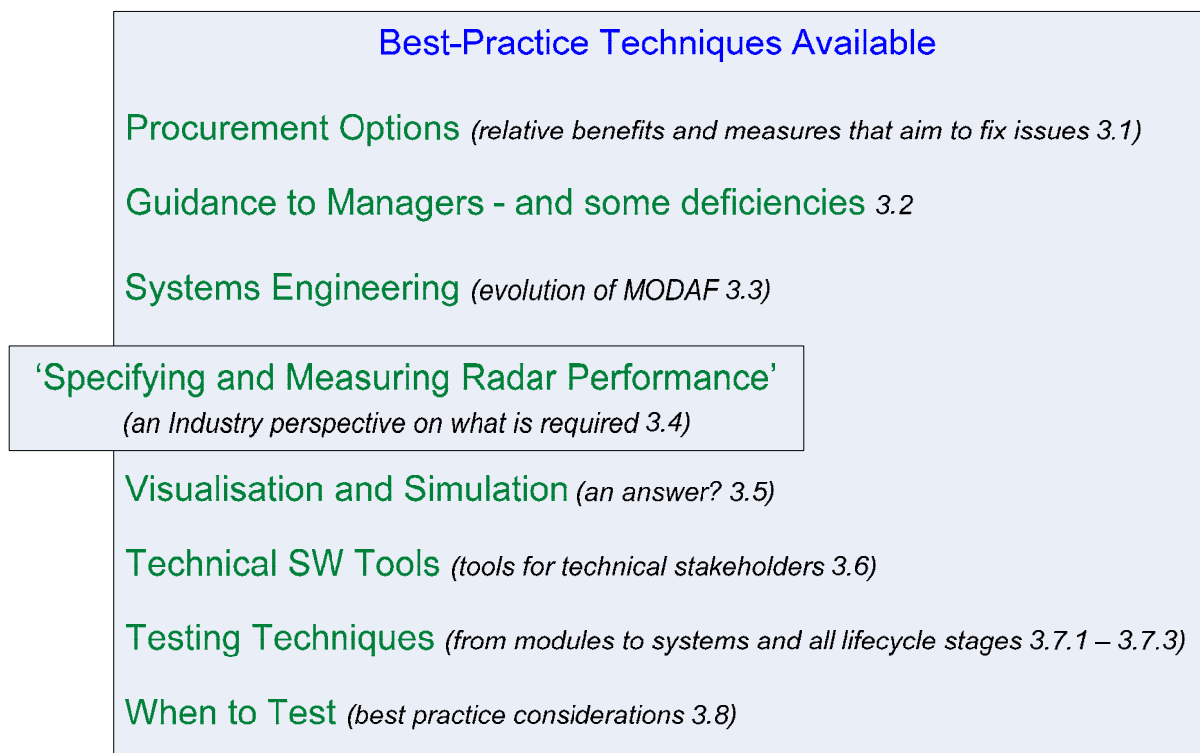

Figure 4 – Ch3 Structure – Best Practice

3.1 Procurement Options

There are four methods of procuring defence equipment and services:

Traditionally Competed Methods (Equipment Procurement Process (EPP)) are used when there is significant risk or new fundamental design required to which the full research capability of the UK and other countries can contribute. These contracts are high value and their method of delivery is intended to provide a leading edge to the defence of participating countries. The QE II Aircraft Carriers are being purchased in this way.

UORs Urgent Operational Requirements are generated when frontline forces identify a deficiency needing urgent remedial action. These vary from major new equipments to modifications upon existing equipments. The Unmanned Air Vehicles (UAVs) Hermes, Reaper and others have been procured this way, as has the Foxhound armoured vehicle to be used in Afghanistan.

PFIs Private Finance Initiative [45] contracts are used for partnership arrangements where a supplier generally provides the capability and recovers the cost in stages after delivery. This format is used for site support and similar estate management tasks. The method was introduced in 1992 by the John Major Conservative Government.

FATS Framework Agreement for Technical Support [46] contracts are let by selection of a number of organisations that are FATS registered. The skills and rates of the organisations are listed and (generally) Project Teams (PTs) requiring a small task to be undertaken can issue these contracts in a simpler way than required for the alternatives. It is usual to compete the potential contract by offering it to selected FATS-registered organisations who then confirm their conditions of acceptance (price-delivery); the PT then selects an organisation and lets the contract.

Other frameworks, run by Dstl and CDE are in place together with other mechanisms, such as Towers of Excellence, for providing R&D and study work.

3.1.1 Contract Comparison

For the purposes of perspective, in 2010 the total value of PFI contracts in progress was £9.5bn compared with £42bn of ‘traditional’ contracts and UORs worth £3.6bn have been issued since the start of the Iraq-Afghanistan wars [47] as shown in Figure 5 where the UORs per year are estimated.

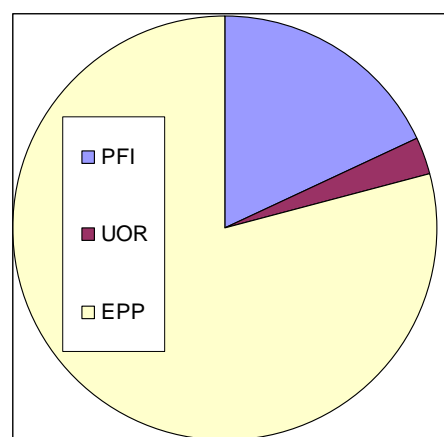

Figure 5 - Contracting Methods' Values

This work concentrates upon the Traditional contracting method, by far the largest of the methods by value; however, the research looks to see if some of the benefits of the alternative methods could be adopted by the Traditional method. The intentions are to speed-up the traditional process and explore the possibility of improving UOR handling by making it easier to compare their wider relationship to other equipment.

| Contracting Method | Benefits | Down-sides |
|--------------------------|--|--|
| Traditional / EPP | Provides leading edge, considered and integrated systems to the front-line | Takes a long time to deliver and is risky, this makes costing difficult |
| UOR | Provides front-line ‘top-up’ to meet specific needs | Can produce duplication and incompatibility with other forces and other front-line systems |
| PFI | Allows good deals to be struck for tax-payer | Changing economic climate can change a good deal into one that is less attractive |
| FATS | Quick and easy to let | Very limited value ceiling and is only used for technical support |

Table 12 - Comparison of Contract Types

A comparison between the contract types is presented in Table 12 and a more detailed comparison is provided in Appendix E. It can be seen from the table that it is usually obvious which contract type is likely to be used given

a particular type of requirement. However, there are surprises relating to UOR contracts. These are intended to be used to ‘top-up’ requirements to an existing specific military equipment that has an identified a shortfall, typically adding a dust filter for engine air-intakes when working in dusty regions. Harrier jets, operating in the wet conditions of the Falklands, needed improved cockpit weather seals that were provided under an UOR contract. Appendix E cites examples of UORs being used to procure items that are outside this definition, for example armoured vehicles.

PFI projects offer prima-facie benefits to the MoD in terms of cost. However, as Appendix E explains, it can and did go wrong when the financial climate changes to the point where the supplier cannot borrow the money to finance the work needed.

3.1.1.1 UORs vs. EPPs

The military perceive UORs to be ‘working’ and EPP as flawed as delivery mechanisms. This is reported by Gray [48] para 7.6 p 134, and others. The Gray report states that the requirements may be simpler than for an EPP and technical risk is less (is that true for an armoured vehicle?) and trade-off decisions are made more rapidly. There is also the issue that those requesting the UOR feel at risk until their requirement is met. They are highly motivated to explain what they need and why, and do what is required to get it delivered. The author could find no research into these aspects but they align with the improved delivery performance of smaller projects as presented earlier. Potentially, both categories have better stakeholder understanding, either because of the reduced level of complexity or motivation to make the key points understood, or both. This research aims to address the communication and understanding issues.

A mix of these contracting methods is discussed in relation to the proposed Enterprise solution presented in section 4.1.

3.2 DE&S Guidance

DE&S is a joint Forces and Civil Service organisation, with contractors used to fill any temporary vacancies. The many rules of procurement, used by Project Teams (PTs), have evolved with the organisation's growth and development. In April 2008, the difficulty of accessibility to the rules, by those who needed to use them, was addressed by the launch of the Acquisition Operational Framework (AOF) [49]. This is a web-based location for the rules. The site has restricted access for others, it is necessary to obtain the authority of the MoD to access it. Access is achieved by applying to the MoD for the allocation of a password. It allows the PTs and Industry to see the same set of rules, a good first step to removing barriers by improving communication.

3.2.1 CADMID Guidance

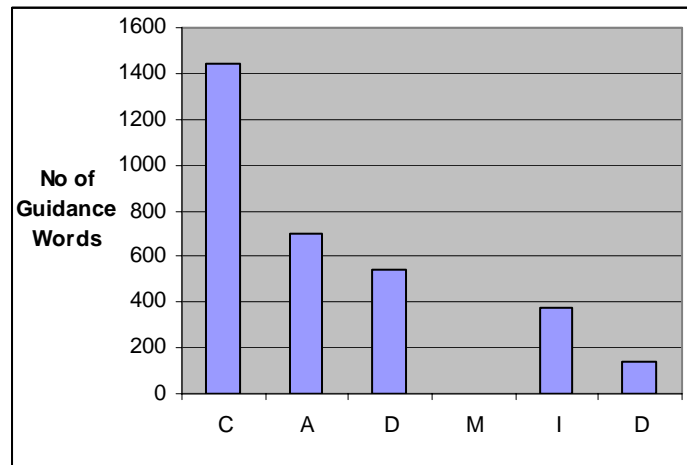

Figure 6 – CADMID Guidance

The CADMID cycle [50] was discussed in chapter 2.2. It is central to the running of a project and guidance is included on the website [51]. An analysis of the information in early 2011, as part of this research, revealed that there is a marked difference in the level of guidance for each stage. Figure 6 shows the number of words of guidance for each stage of CADMID. It will be remembered that, in general, the 'CA' parts of the cycle are performed by the customer and Dstl, and the 'DM' stages are performed by Industry. The reduction in guidance as the lifecycle proceeds is partially justified by the philosophy that appropriate work done early will save much

work being done later in the project. However, the NAO Major Projects' Reports show that projects overrun during the 'DM' stages. (Projects are launched from Main Gate with a contingency around 70% of total cost that needs to be exceeded before a cost overrun is reported). This indicates that there is some justification in reviewing the post Main Gate process of monitoring and controlling a project in the 'DM' stages of CADMID for which sparse guidance is currently offered to the PTs. This research proposes a continuous monitoring process.

3.2.2 ITEAP Guidance

Attention is given in the guidance to having PT staff produce an Integrated Test Evaluation and Acceptance Plan (ITEAP). The TEST PT in DE&S has produced guidelines for this that are also on the AOF website [52]. There are 7 sections to the proposed structure of an ITEAP and the need for 8 Annexes is identified. In late 2011, the TEST PT held a series of 'open-days' to introduce, PTs to the need for, and importance of, an ITEAP. PTs with involvement in Air, Land, Sea and Joint Projects attended, the talks were supplemented by industrial involvement that included demonstrations, by the author of this thesis, of a system test shell (resulting from this research). At one of these events, on 19th September 2011, in discussion with the author of the website material, it transpired that the TEST PT has difficulty in persuading project PTs to produce ITEAPs. To quote the source:

'too often, there is a tendency to write a document with the appropriate title and put it in a drawer to be produced only if asked to confirm they are following the procedures'

This observation was confirmed in a further conversation, on 24th November 2011, with Cap JTES personnel (a Whitehall Capability Group who advises the senior military and guide policy, in this case for Joint Training Evaluation & Simulation). It was felt by Cap JTES personnel that the people in DE&S were under-trained and inexperienced. A person being asked to produce these documents and follow the guidelines was likely to have recently returned from active Service in a war zone. These people would

have little or no previous experience of the DE&S functions. They undertake a re-orientation course at the Royal Military College of Science before their deployment to DE&S. During this course, the TEST PT provides a half-day presentation about the CADMID/ ITEAP issues.

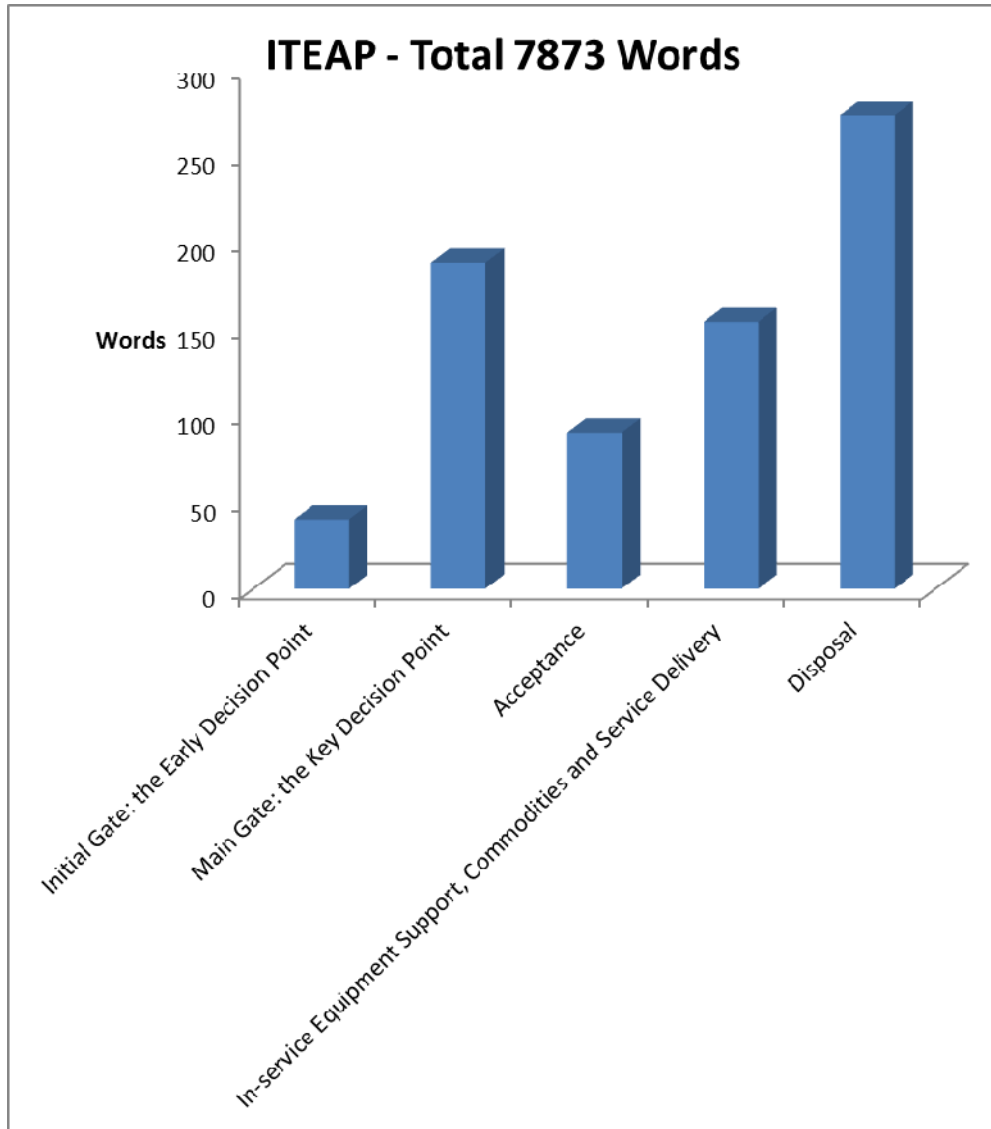

Figure 7 – ITEAP Guidance

ITEAP guidance document comprises 7873 words of which 745 words (under 10%) relate to the specification test, evaluation and acceptance of materiel. The number of words in each section is shown in Figure 7. The rest of the document defines terms, the procurement vision, why it needs to be done well and why it needs to change to this approach. Clearly, the overview is needed but some substantial guidance is also needed if the vision is to be realised. This does not provide a level of information

comparable to the detail provided in the Radar Specification [53] for test and evaluation of radar equipment; nor does it refer to any further sources for any materiel for which an ITEAP is needed. Notable in the figure is the lack of guidance for the manufacturing stage when suppliers are producing the materiel.

In 2011 and early 2012, four staff from Dstl had been seconded to the TEST PT to encourage Air, Land, Sea and Joint PTs to produce ITEAPs. They were offering to review any ITEAPs produced. In February 2012, a 12-pages long checklist was added to the website. It is quite thorough, covering many situations of which a sub-set can be expected on a specific project. It is, therefore, a little daunting to read and implement, particularly given the background of those being asked to produce an ITEAP. This possibly helps to explain the issue of 'write and forget' quoted above.

3.2.3 DE&S Guidance - Summary

The NAO reports of projects being overspent means that they have exceeded their budget by around 70% (see section D.5) and this happens in the 'DM' stages when the budgets have been set following the 'CA' stage work. The CADMID guidance for PTs at the 'CA' stages is clearly not succeeding in establishing an appropriate basis for projects to proceed to the 'DM' stages. Alternatively, or maybe as well, the reduced 'DM' stage guidance is failing to maintain the intent of the specifications provided to industry.

The reasons for the failures were analysed in chapter 2 (section 2.3) and included changes of various types, including numbers of equipment required, unforeseen (intentionally or otherwise) budgetary constraints. Attempts to recover the situation includes relaxation of DLODs to such an extent that equipment is delivered that cannot be used until remedial work is undertaken. Unsurprisingly, this is contrary to the guidance offered for CADMID or ITEAP that aims to prevent such situations. It has been substantiated that the PTs are not using the guidance as much as they should. Furthermore, guidance is weak at the time in the lifecycle that the problems emerge.

That the guidance on technical issues is not generally adopted is not surprising given the skill base within DE&S not being technically orientated.

This research proposes removing these aspects from the remit of DE&S staff to specialist T&E teams that are independent of both the main contractor and DE&S. However, the teams would provide the information to DE&S in a way that, as project managers, they can use to advise their customers (Chiefs of Staff).

3.3 Systems Engineering

Around 1996, in the USA, interest in the use of synthetic environments to explore systems experienced a rise. This resulted in the production of a high-level architecture (HLA) definition that allowed systems to be built and their components interfaced according to a set of rules. This triggered a series of significant items of work that adopted the techniques. A synthetic environment structure definition, FEDEP (Federation Development and Execution Process) [54], was followed by its European counterpart, SEDEP (Synthetic Environment Development and Exploitation Process) [55]. SEDEP was produced as a Western European Armaments Group (WEAG) initiative to be more suited to European applications; it adds two more stages to the process.

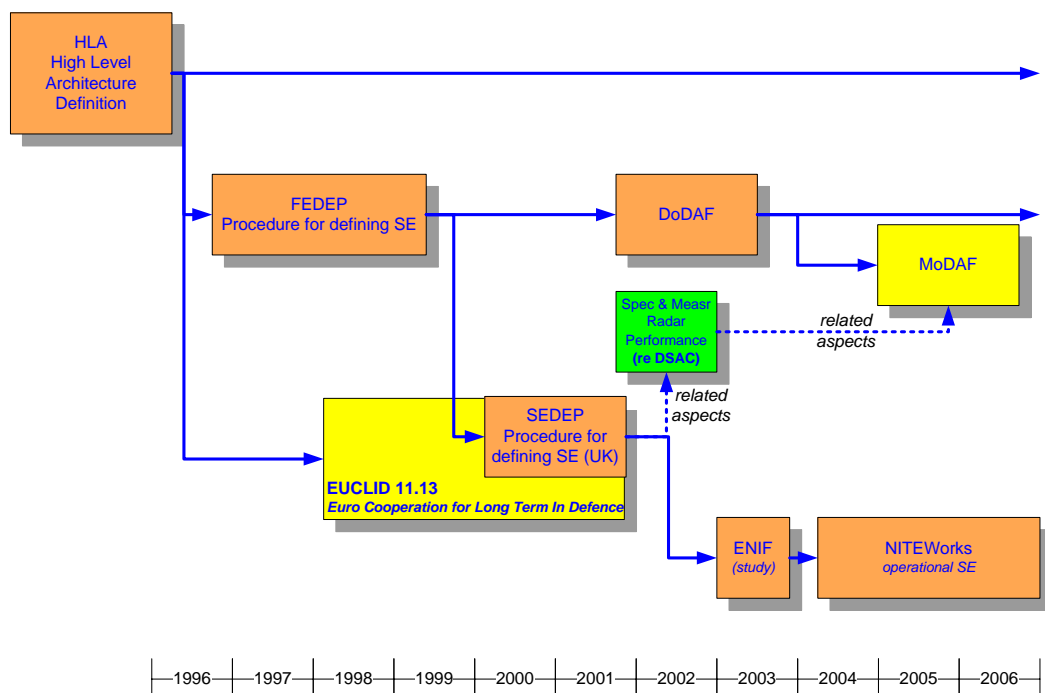

Figure 8 – Systems Engineering Evolution

The relationship between these initiatives, and the others that they spawned, is shown in Figure 8, the main points are described in the following chapters. The paper ‘Specification and Measurement of Radar’ is shown in this diagram for reference and is discussed further in chapter 3.4.

3.3.1 High Level Architecture Definition (HLA)

HLA is a late 90’s development and now may seem to be commonplace, so the description is intentionally brief, providing little more than a definition of the term.

HLA defines an object-orientated approach to system architecture. The objects, generally representing real-world components, have definitions of performance and rules of interaction. The HLA definition specifies both of these. The architecture defines an object-model for each object, as well as simulation and management object models. A run-time infrastructure allows a particular computer to run the models making it specific to a computer language and computer environment; it is written in C++ with various interfaces including Java and ADA.

It was strongly advocated by the US Department of Defense (DoD) in 1999 [56] and a number of funded projects resulted from this. The Canadians have also adopted the concept and a notable example is a hardware-in-the-loop precursor validation for an unmanned air vehicle (UAV) test flight to patrol littoral waters. This was an Atlantic Littoral Waters (ALIX) test flight [57] that deployed a UAV under controlled conditions. They claim a development time of a few months for the sensors and flight control systems. The tests were conducted on a simulator before real-world deployment, with two reconnaissance areas being covered by the vehicle without incident.

3.3.2 FEDEP

HLA implementations rapidly become complex when a complex system is being modelled. To help structure the approach, FEDEP [58] was introduced in 1999 and can be considered to be a level above HLA in a hierarchy. In

this context, the word ‘federation’ has its predominantly American connotation meaning a group (of objects).

FEDEP is a 6-stage process:

1. Define Federate Objectives
2. Develop Federate Conceptual Model
3. Design Federation
4. Develop Federation
5. Integrate and test Federation
6. Evaluate Federation and Prepare Results

The steps are self-evident from their names but it is a well-documented process with detailed links between the various stages and how these relate to the various HLA models and operating environment.

3.3.3 EUCLID 11.13 – SEDEP

EUCLID is a European Union Co-operation for the Long-term In Defence funded by the Western European Armaments Group (WEAG) that, in turn, is funded by 13 nations’ Ministries of Defence. The 13 nations comprise Denmark; Finland; France; Germany; Greece; Italy; The Netherlands; Norway; Portugal; Spain; Sweden; Turkey and the United Kingdom. SEDEP [59] is a European variant of FEDEP. It was developed from WEAG Common European Priority Area (CEPA) work package 11.13. The work was undertaken between 2000 and 2003 and is strongly based upon FEDEP with two extra stages introduced to make it an 8-part process, notice that the numbering starts at zero to align better with the FEDEP standard.

0. Analyse Users’ Needs
 1. Define Federate User Requirements
 2. Develop Federate System Requirements
 3. Design Federation
 4. Implement Federation
 5. Integrate and Test Federation

6. Operate Federation Model

7. Perform Evaluation

SEDEP development process is well presented in their process definition (The Euclid RTP 11.13 Synthetic Environment Development & Exploitation Process) [60]. The European involvement was seen as important for purposes of pan-European procurement, training and rehearsing multinational operations, all of which are significant for this research. Therefore, straying too far from the SEDEP recommendations is not advisable. The description of the process makes the point that common processes; common tools; common standards and generic solution for all problem domains are needed. It also emphasises the need for a common data repository for various levels of access by subscribing nations and companies. Both points are echoed in this thesis.

A number of tools have been developed to move the FEDEP/SEDEP environments closer to the Integrated Development Environments (IDE) familiar to software developers. One such example is the Federation Composition Tool [61]. The tools help in the preparation of documentation in the format defined by the standard, almost a set of templates for the definition of a system.

3.3.4 ENIF & Niteworks

ENIF (Experimental Network Integration Facility) [62] was a scoping study designed to identify how Niteworks¹⁵ (Network Integration Test and Experimentation Works) [63] could work and support the development of the MoD equipment procurement Business Case. The scoping study commenced on 16th December 2002 and engaged with over 80 people from a broad section of the UK defence industry and MoD.

The Niteworks programme was launched in June 2003, just 6 months after the launch of its scoping study, and operates with ‘themes’ – strands of

¹⁵ Niteworks is the current capitalisation regime for the organisation, originally it was NITeworks.

investigation from logistical support to kill-chain¹⁶ evaluations. The Niteworks website explains their objectives [64]:

“It can be used to help an MoD customer do the following types of activities: define the scope, concept of analysis and cost of solving a complex problem; provide thought leadership via a strawman paper; develop a short document that supports capability development; or exploit previous work to support an upcoming decision. (<http://www.niteworks.net> –November 2009)”

Exercises are run within each theme involving simulation facilities of partners and associates that are not necessarily co-located. These ‘high-level’ visualisation exercises typically involve interactions between multiple platforms, similar to computer gaming. Equivalent exercises for single equipments are not typical of Niteworks, but could be considered a useful extension to explore options for the development of single platforms.

The scope of Niteworks projects has reduced in recent years. Projects are now predominantly paper studies conducted by consortia of Niteworks members drawn from industry. The projects typically run for 2-3 months. Niteworks is funded by CAP JTES at around £6M per year and is administered by BAE SYSTEMS. Studies are each charged at an agreed rate.

3.3.5 DoDAF / MODAF

A 2005 initiative was the introduction of the Ministry of Defence’s Architectural Framework (MODAF) [65]. This was derived from the US Department of Defence’s DODAF [66]. These are enterprise models, meaning that they are intended to cover and unite all aspects of a project including business and technical aspects. The original purpose of MODAF was to assist with the development of equipment that could be built into network centric systems of systems. MODAF defines a project by 6-‘views’¹⁷

¹⁶ ‘Kill-chain’ is a military concept that includes target identification, assigning appropriate assets (aircraft/ground forces etc.), threat confirmation, an order to attack and finally, the destruction of the target.

¹⁷ <http://www.mod.uk/DefenceInternet/AboutDefence/WhatWeDo/InformationManagement/MODAF/>

- 1 **All Views Viewpoint (AV)** An overarching description of the architecture, its scope, ownership, timeframe and all of the other meta data that is required in order to effectively search and query architectural models
- 2 **Strategic Viewpoint (SV)** These views support the process of analysing and optimising the delivery of military capability in line with the MOD's strategic intent.
- 3 **Operational Viewpoint (OV)** These views describe a requirement for architecture in logical terms, or as a simplified description of the key behavioural and information aspects of an existing architecture.
- 4 **System Views** Describe the resources that realise the capability.
- 5 **Technical Standards Viewpoint (TV)** Standards, rules, policy and guidance applicable to aspects of the architecture
- 6 **Acquisition Viewpoint (AV)** Describe programmatic details, including dependencies between projects and capability integration across the Defence Lines of Development (DLODs)

More recently, a 7th view has been added

- 7 **Service Oriented Views** Specify Services that are to be used in a Service-Orientated Architecture (SOA).

The DoD version does not have the Strategic, Acquisition or service views. Each view has a set of pre-defined models, tables, lists etc., which can be described as work sheets, although few projects would have a fully populated set. This is a strong move to standardisation and re-use of specifications.

3.3.5.1 *Wider Issues*

In a single system, intended for a specific purpose, the application of these models to its development is likely to be straightforward. If the system is simply providing a 'yes/no' result operator interaction is minimal. However, the types of equipment considered here are themselves more complex and often form part of a system of systems. Human operators introduce more degrees of freedom to the outcomes from a set of fixed initial criteria. It is

therefore, difficult to predict the outcome. For example, if a radar produces a false report of a hostile target close to the platform an operator may understand that it is likely to be false and ignore it. Furthermore, an operator may easily recognise it as a false target and prevent the equipment part of the system trying to process it. In this way, capability is enhanced. Alternatively, the operator may concentrate upon it, paying less attention to other (real) reports that pose greater and real threats. This can reduce the capability of the system.

If the assessment of equipment requires the intervention of an operator, commonly referred to as a 'man-in-the-loop' system, it will be appreciated that the equipment supplier would prefer an operator trained to respond appropriately to the unfolding situation of the test. This would enhance the perceived capability of the equipment, as described above. It would be preferable to have the tests prescribed in detail, so that the operator can react according to a plan. Even better would be the ability to repeat tests in an identical way so that the operator can practice and hone responses.

Where environmental conditions, such as sea states play a part, it can be impossible to prescribe a definitive sequence in detail for live (real-world) tests. It is certainly not practical to repeat the sequence and practice responses. Trials can be abandoned because of failure of appropriate environmental conditions being experienced during the trial period. A 'man-in-the-loop' broadens the range of potential outcomes, some of which may be acceptable and others not. Clearly, a test shell that replicates the real world has the capability to provide the missing elements of prescription and repeatability experienced during real-world (live) testing.

3.3.6 Systems Engineering - Summary

The structure for lifecycle test and validation proposed in this research is based upon Systems Engineering concepts founded in HLA. The 8-step SEDEP model defines the breadth of conceptual coverage needed for the successful implementation of a project. The Niteworks value-added was the development of visual 'gaming' type techniques to present a range of

stakeholders with insights into operation that would otherwise not have been apparent until the equipment was in-Service. Finally, the MODAF framework is useful in drawing attention to aspects of describing a project in a way that relates to the stakeholder perspectives. However, it has not been widely adopted by industry.

3.4 Specifying & Measuring Radar Performance

A little prior to ENIF, a significant report, ‘Specification and Measurement of Radar Performance’, was commissioned by the Defence Scientific Advisory Council DSAC a government advisory body¹⁸. It included many industrial and academic members chaired by Prof Simon Watts (Thales). Figure 8 shows this work in relation to the Systems Engineering evolution and the ENIF report that led to the formation of Niteworks.

The report was summarised in a paper presented at RADAR 2002 [67] a conference organised by the Institution of Electrical Engineers - IEE (now The Institution of Engineering and Technology – IET¹⁹). The information included here is derived from that paper and the Ward, Tough, Watts book, published 4 years later, ‘Sea Clutter: Scattering, the K Distribution and Radar Performance’ [68]. The final chapter of the book has the same title as the paper. The work is subsequently referred to as the ‘Specification and Measurement paper’.

The work presented the difficulties in specifying requirements; this is exacerbated by radar equipment being increasingly complex with multiple modes of operation. Radar modes can change dynamically, according to the strategic rules that apply to the tactical situation encountered by the radar platform. It is clearly impossible to exercise all modes in all operational scenarios, simply because of the number of combinations that exist. If the radar was part of a defensive aids suite and engagement of a target is

¹⁸

<http://www.mod.uk/DefenceInternet/AboutDefence/WhatWeDo/ScienceandTechnology/DSAC/DsacOrganisationRolesMembership.htm>

¹⁹ <http://www.theiet.org/>

required, the options are further extended and exhaustive live testing becomes even more impractical.

The work proposes working from the capability specification (System Requirement Document – SRD) that is the responsibility of the customer, to a parametric technical specification, the responsibility of the supplier, before the main contract is let. Associated with these would be a definition of an agreed quantitative acceptance criteria as part of the ‘A’ stage of the CADMID cycle prior to the main contract being let.

The work recognises the difficulty in reconciling these views to provide a set of agreed acceptance criteria. It provides graphic examples of potential areas for dispute – for example, the range of clutter parameters that can be assigned to a particular sea state can affect the probability of detection and false alarm rate.

Fluctuations of $\pm 10\text{dB}$ are quite possible for a small target. The clutter reflectivity is notoriously variable, with spreads of $\pm 5\text{dB}$ for apparently similar conditions (e.g. wind speed or sea state). [68] Page 327

This point is discussed further in section 5.5 of this thesis.

3.4.1 T&E Issues

It is clear that there is a challenge in testing adequately something that is difficult to specify. The paper acknowledges the inadequacy of ‘static’ performance testing – measuring detection range for example, and advocates ‘deterministic testing’ – looking for a predefined response to a set of circumstances. The paper goes on to promote simulation as a way to achieve this, with only key-points in the performance envelope validated by trials. It suggests that the testing of key sub-systems’ individual performance (signal processing is used as an example) may be required. This could be achieved, as for the full system, by modelling or applying pre-recorded data (maybe with synthetic targets added). However, the models would need to be understood and trusted by all stakeholders to represent adequately the real equipment and environment.

The paper proposed that simulation could be used to model aspects of the system during the ‘Development’ stage of CADMID, specifically signal processing performance. The use of scenarios was guardedly proposed, the danger of designing to meet specific scenario criteria, rather than a generic need, was cautioned in the paper, although this was not present in the book.

The paper concluded that close cooperation between the whole stakeholder group (supplier, customer and users) is needed; there are likely to be emergent issues (this author’s phrase) that would call for flexibility on all sides. The book refines this to making the SRD not too detailed, being limited to essential performance parameters, and giving the supplier flexibility to trade detailed parameters whilst meeting the essential ones ([68] page 314).

3.4.2 Building Upon the Work

‘Specification and Measurement of Radar Performance’ is a seminal work in relation to the specification, evaluation and testing of radar systems. This research was strongly influenced by the work and the concept is extended to sensors other than radar. However, the work retains the customer-supplier boundary assigning responsibility for System Requirements Document (SRD) to the customer and Technical Specification to the supplier. This research proposes a more holistic approach, placing the ‘customer’ and ‘supplier’ as part of the same team and, very importantly also adding ‘Users’ (operators), each with a contribution to make at all stages of the lifecycle. This removes the need for a definitive operational – technical boundary to be created prior to contract, a pre-requisite that the Specification and Measurement work acknowledges to be flawed ([68] page 313).

Modern adaptive sensor systems are complex but are not necessarily required to operate autonomously. An adequately trained man-in-the-loop can add much value as described in section 3.3.5.1. There is a danger that the performance of the system (in this case man+radar) becomes confused, in the minds of specialists, with the performance of the specialist

component (in this case radar). Acceptance of this concept allows an alternative degree of freedom in meeting operational needs. The focus of problem solving can shift towards effective communication rather than solely fixing technical issues to meet the terms of a contract.

For example, given a test-shell capability (described in more detail in section 4.2 onwards) and the variation of target and clutter parameters specified earlier, it would be possible to demonstrate the capability of a given technological solution. This would allow an operator to work with it at an early stage and provide relevant design feedback. For example, it could support exploration of temporal correlation of false alarms due to movement of the platform in relation to a patch of clutter (as described in ref [68] page 319). A technical solution might include larger memory to store longer periods of information and improved processing. However, it might be readily solved by human processing rendering complex electronic processing unnecessary. The communication technique proposed here, based upon a visual presentation of results from a model of the (possibly sub-optimal) technological solution would allow operators to engage in the decision making much more effectively than could be achieved by other means. It is clear that a technical explanation using probability theory would not be an effective communication technique in such cases.

User Interfacing is an aspect that is currently addressed by the defence equipment supply community. Here we are considering including this as a standard assessment feature as part of T&E rather than a separate design task. Issues of ‘performance measurement’, as discussed in the seminal work, are given a new dimension by this approach and this is important when systems of systems – for example data fusion or Combined Defensive Aids Suites (CDAS) systems are being considered. In these cases, responsibilities for problem solving are naturally devolved between suppliers.

Given access to appropriate technical skills and experience at the very earliest stages of CADMID this research proposes the development of such scenarios prior to any contract being let. The difficult situations would be

introduced early so that potential contractors could evaluate their methods of meeting these issues from a very early stage. This is discussed further in section 4.1.

The more complex testing, the report proposes, needs to be restricted to models of the system, with spot verification of results by using hardware-in-the-loop (HWIL) testing (see definition page 2) in a live test. This research proposes a more integrated approach but retains the spot verification method.

Unlike the ENIF report, the author cannot find any direct evidence of exploitation of the work to produce, for example, a standard for low-level validation of (in this case radar) systems.

The work may have influenced the growth in visualisation systems for 'serious games' use. These are considered in the next section.

3.5 Visualisation and Simulation Software

The term 'serious games' is used to describe the use of computer gaming technology for more serious use, it has grown into a mini-industry as an internet search will reveal. It is now used by the military for soldier training. Simulation in 2002 was exemplified by Microsoft Flight Simulator 2000/2002 and similar games programs for personal use. Such widely available products did much to promote the concept of Synthetic Environments, Modelling and Simulation. A history of them, together with some screenshots, can be found on the web [69]. In the following years, simulation was a popular concept in the defence sector; many larger defence contractors introduced theatre-style visual presentation capabilities. The Niteworks organisation started to utilise such systems from around 2004 as previously described (section 3.3.4).

The previously mentioned MoD initiatives (DIS/DTS [70]/[71]) supported this approach and gave rise to grand-scale demonstration facilities being developed by prime contractors. Typically, these facilities comprise a small theatre with rows of staggered seats and multi-projector screens – generally

3-screens to provide wide-angle views. The MoD and other customers are then presented with high definition 'computer-games' showing the benefits of a prospective solution to a problem. In some cases, these can be linked to operator consoles where people interact with each other in an evolving military situation (a scenario). The main viewing room can project the overall view, or that of any operator, so that dignitaries can be persuaded of the proposed system's efficacy, based upon visual, scenario-based, synthetic environment techniques.

Such facilities as these are owned by EADS in Wales, QinetiQ, BAES and others. To avoid copyright issues, information can be found on their websites²⁰. Smaller scale test and demonstration capabilities exist that are project specific, examples include a wooden construction cockpit simulation with 'real' instrument panels and an outside view projected onto a screen. The cockpit controls drive a simulation of the flight model of the aircraft and information is used to control both the projection and an instrument panel. Although this is not a sensor example, similar ones exist with the simulator replicating the performance of the system being tested.

The full-scale projection systems require racks of equipment, one reason that they cannot be moved easily. An example of a General Dynamics PC based system can be found on their website²¹. This is claimed to be portable although it occupies 4 x 6-8 ft high racks – two double wardrobes, but much heavier. Currently VBS2 [72] is being widely adopted by the UK MoD to contribute to development of concepts, validation at the earlier stages of the lifecycle and user training at the end of the lifecycle.

²⁰ EADS website for NETCOS -

http://finance.eads.net/1024/en/investor/News_and_Events/news_ir/2006/2006/20060210_netcos_uk.html

QinetiQ website for Quest Synthetic Environment

http://www.qinetiq.com/home/defence/defence_solutions/command_and_control/cyber_testing/quest_synthetic_environment.html

BAES MSVA Technology

<http://www.baesystems.com/Capabilities/Systemsintegrationandelectronics/SyntheticenvironmentsSimulationModelling/index.htm>

²¹ General Dynamics 'portable' PC simulation system

<http://www.gdc4s.com/content/detail.cfm?item=35019190-1ef7-4960-be24-8b2c45c141e7>

Outside their use by Niteworks for system-of-systems and operational investigations, these systems allowed the contractors to present proposed single-equipment solutions to customers' problems. These installations were primarily marketing tools; the better ones could be extended to training.

They are so large, expensive and immovable that project design teams have, at best, difficulty in gaining access to them. At worst, they are not available or unsuitable for detailed design verification.

Verification of sensor equipment highlighted by the Specification and Measurement chapter (10.3 –Performance Prediction) in [68] identifies detailed sea-clutter parameters of reflectivity, amplitude statistics, temporal correlation and discrete clutter spike characteristics as being important for verification of a radar. These combine with radar frequency, polarisation and spatial resolution and use of pulse-to-pulse frequency agility to produce a return that is further dependant upon grazing angle, wind speed and direction and sea swell and direction to provide a return as described on page 323. These tools were not designed to, nor do they, address these more technically demanding issues. They do provide an overall impression of the capability that is offered.

This leaves a gap in the necessary capability to meet the test and verification need.

For these reasons, this research takes a different technical approach. In addition, the T&E environment needs to be small, compact and easily re-located. It needs to be of low-cost so that many of them can exist. Ideally, they would be tomorrow's test equipment that would form part of every Engineer's tool-kit. These aspects are explored in section 4.9.

3.5.1 Geographic Displays

Geographic display software is a sub-set of visualisation techniques. It overlaps with serious games software that produces imaginary environments in which to run the games. An example is the current defence activity to produce an imaginary island in the Atlantic Ocean comprising features of real areas of the world. Mountainous, desert and other terrains are selected for mapping. This imaginary area will support military training activities, including (synthetic) ground troop movements, shelling etc., without upsetting the sensitivities of those whose territories are the real locations.

This category includes Google Earth and Digital Terrain Elevation Data (DTED) mapping. Google Earth is the best known of these and is free for personal use although a small fee is payable for commercial use. DTED is produced by the American National Imaging and Mapping Agency for military use and has roughly 1 km square tiles in its basic form. Google offers a higher resolution without the licensing issues associated with the military system.

3.6 Technically Based Software Tools

The previous sections describe the visualisation aspects that find favour with the managerial and more operationally orientated stakeholders. However, there are a number of important but much more technically orientated tools available to the design, development and other technical stakeholders.

To meet our purposes it is necessary to identify a technically orientated tool that supports a number of sensor types in a coherent way and has good visualisation. The tools found during this research fall into two categories, basic programming tools that have general application and specialised tools tailored for a specific application. It will be seen that the outputs of these tools do not have the visual impact that would make them relevant to the non-technical stakeholder group.

Amongst the general tools are programming languages, one of the most popular being of the C/C++ type. System C is an open-source C++ template library used to model designs in software. It enables simulation of concurrently executing processes and communication between them, at high, low or mixed levels of abstraction. It is possible to mix technical and visualisation techniques in this way. As an example of the benefits of providing this mix, it has been used by the sponsoring company for the visualisation of trials data during their acquisition. Such bespoke applications have been used to inform decisions about the quality of data being collected. If the available data are not adding value to decision-making, an expensive trial can be terminated for example.

A synthesisable subset of System C has been defined and proprietary tools are emerging, able to derive hardware designs from models restricted to that subset. However, in general, System C models are maintained independently of the final implementation in hardware. Also in this group are general-purpose modelling tools that support either graphical or mathematical-expression building of systems with executable features. The list in

Appendix F Table 29 describes the more popular ones in this group that were reviewed during this research.

Within the specialised application group, there are tools for modelling at the level defined by FEDEP/SEDEP standards to produce ground truth and interactive simulations. Research revealed the most popular ones that are listed below in Appendix F Table 30.

A further group was identified, at a deeper level of abstraction, which supports RF modelling; these are shown in Table 31.

Finally, in this section of the research, there are tools that support integration of hardware-in-the-loop (HWIL) techniques with computer techniques and are of particular relevance to this study - Table 32.

It can be seen that the number of tools reduces as the level of abstraction deepens. The US Military, particularly the Navy, are strong supporters of simulation techniques and funding for industry springs from this interest.

3.6.1 Existing Software Tools – Summary

There is a good range of visualisation and technical tools available. This research did not identify any attempts at integration of these two groups. The existing simulators are ‘visual/games’ only, without physical reality that could be used to stimulate equipment. This restricts their suitability for hardware and software in-the-loop testing. Where technical data are produced, ‘in-the-loop’ testing can take place but the results are for the eyes of specialists. This research aims to bridge this gap to bring technically sound techniques to all stakeholders simultaneously at all stages of the lifecycle by including visualisation of scenarios as they unfold. The terrain mapping tools offer location realism that is attractive for engaging with military users. Within this limited group, Google Earth offers an attractive way forward because of its popularity and general acceptance (this reduces learning curves). It is also generally available and avoids the need for addressing military licensing issues.

3.7 Testing Techniques

Rex Black, in chapter 1 of 'Managing the Testing Process' [73] explains the basics of testing methods in some detail, the important ones are summarised in the paragraphs that follow. There is some latitude in interpretation of the terms, for example selected value and boundary value methods may be considered by some to be variants of both black and white-box testing.

Black box testing – a module's transfer functions, from inputs to outputs, are tested with no prior knowledge of the internal operation. This is a test method to demonstrate functionality and performance.

White-box testing – paths through the module are known and tests designed to verify them. This is a method primarily to demonstrate failures and it assumes knowledge of what is inside the box, also called 'clear box testing'.

The following more detailed variants of the above serve to illustrate the methods more clearly.

Selected Value testing – one or more input data sets are applied and the outputs checked for expected values. A simple variant of this is to apply one signal and obtain one output – an example being the gain of an amplifier at a defined frequency, more complex testing would include gain-bandwidth plotting.

Boundary testing – near maximum and minimum values are applied to inputs, and outputs are measured, there may also be variants of inputs to achieve near min/max outputs

These techniques will be referred to again at the end of this chapter when a generic concept is developed.

3.7.1 Test Environments

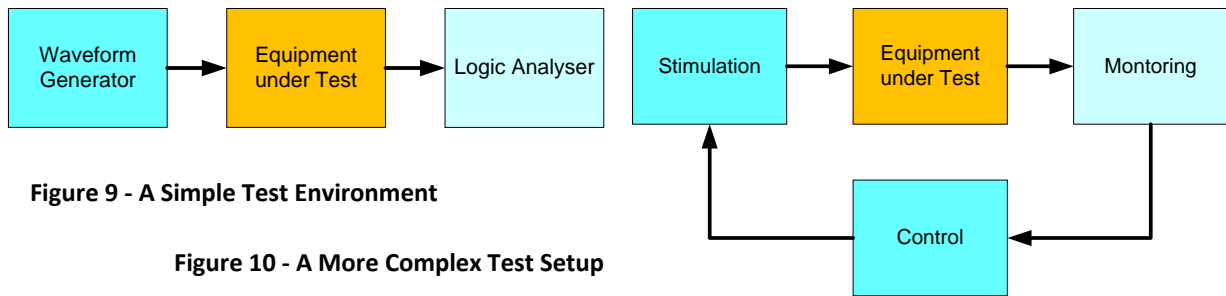

Figure 9 - A Simple Test Environment

Figure 10 - A More Complex Test Setup

Electronic testing is well served with test equipment, the most popular items being logic analysers and signal or waveform generators of various types. These latter equipments are used to provide signals to stimulate the equipment under test and the former to monitor the results, a typical set-up being as shown in Figure 9. These equipments are not project specific so they offer reuse on the same or different projects. They are also COTS equipments. This is adequate for low-level testing but there comes a point in a project's evolution where such basic equipments are not adequate because, for example, many complex inputs or conditional tests are required that are beyond the capability of these equipments. This is the point at which Engineers specify and design bespoke test equipments, for such complex issues as providing a rapidly changing target track in a noisy background, to see how well a tracking algorithm can cope. In the jargon of this section of the industry, such background noise would be referred to as 'clutter' and many complex clutter environments are known to represent land, sea, littoral and urban areas.

Complex Environment More complex test environments, such as that considered here, involve feedback as depicted in Figure 10, so that the stimulation is modified according to the performance of the system-under-test. For example, a radar system may switch modes between detection and tracking as a function of the types of targets detected and the tracks they are taking. In this research, the closed-loop test environment is re-drawn for simplicity as shown in Figure 11. Here the input and output signals can be seen as previously, with their unidirectional arrows. A bi-directional arrow has been introduced at the bottom of the unit-under-test to show that the

control system can also interact with it. For example, the equipment under test may have to change its gain or mode of operation. This link can also be used to receive status information about changing modes of operation. The functions of stimulation, monitoring and control are incorporated into the ‘test-shell’ shown in the diagram.

It will be seen that this depiction of a test-shell applies to all of the testing techniques described at the beginning of this section, the difference would be the increased level and depth of tests employed using the test shell.

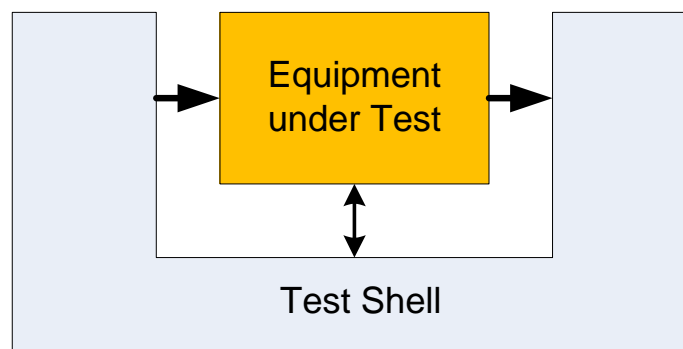

Figure 11 - Alternative Depiction of a Complex Test System

3.7.1.1 *Test Shell Example and Lessons*

The test shell technique is currently in use within the MoD. An example is the naval combat Shore Integration Facility (SIF) on Portsdown Hill, Hampshire. This test shell is used to integrate combat sub-systems following their delivery from industry. The SIF is managed by the DES Ships at Abbey Wood and has been in existence for over 10 years.

A series of workshops culminating in interviews and issuing questionnaires was undertaken by the author of this thesis as part of a study into the use of simulation for the purposes of test and evaluation (SimTE). The study, funded by Cap JTES via the Synthetic Tower of Excellence, took place in 2011. The full report is/ will be available via Dstl [74]²² but some relevant points are included here. The names of interviewees (around 40 people) are available separately for confidentiality reasons.

²² The report may be incorporated with others before final release.

The participants were all familiar with the SIF, and hence the principle of a test shell, and were asked about their perceptions of benefits and concerns. The consolidated results are shown in Table 13.

| Benefits | Concerns |
|--|--|
| Enabling complex and difficult testing, that are difficult or impossible to do live | Quality of results |
| Environmental benefits | Trust and confidence in simulation * |
| Safety benefits | Availability of information to support the management of simulation in T&E |
| Versatility benefits (greater number of scenarios, environments, target types, etc.) | MOD cultural, process and organisational issues that inhibit simulation in T&E** |
| Cost savings | Perception that the quality of results from live test is higher than from simulation |
| Time savings | Availability of information to support the management of simulation in T&E |
| Repeatability | |
| * All questioned believed this to be an inhibitor | |
| ** a key constraint | |

Table 13 – SIF Test Shell – Perceived Benefits and Concerns

The concerns are of interest. The age of the equipment used in the SIF may account for some of the quality of results issue. The trust issue is ongoing. This research offers a way to address this by

- involving stakeholders at all stages of the verification process
- Re-using the environment so that improvements ratchet-up confidence by applying to all systems

Addressing the cultural issues forms a large part of this thesis and is included as part of the Enterprise change proposal. The perception of the quality of results re live trials may be addressed by the stakeholder involvement and the continuous improvements that are offered by the use of a generic system.

The participants in the study were asked about the potential benefits in the following areas, where they gave very positive answers.

- Supporting CONOPS
- Improving stakeholder communication
- Induction of new people
- Re-use of System Components
- De-risking trials
- Helping communication with Allies

Their estimates were that a SIF-like facility saves at least 20% of the budget for each activity. These figures were perceptions of the participants and were not verified by any other means as part of the study.

However, the SIF is used only for integration of sub-systems; early and subsequent stages of the lifecycle were not part of the remit of the SIF. When questioned about other areas of potential savings, the results in Figure 12 were obtained, showing the number of participants who would support the proposed extensions to its use. In addition to these quantifiable results, there were other less quantifiable issues relating to MOD culture, strategy and process raised that were deemed to be outside of the scope of the SimTE study but were noted as being important by the study team. They can act to counter the benefits that M&S can bring to T&E and they are addressed in this research.

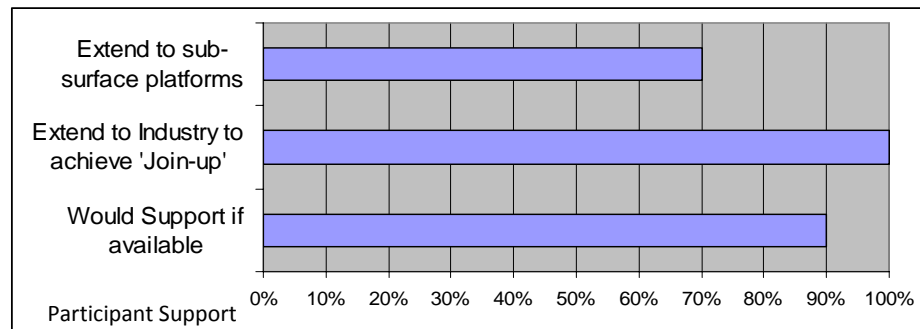

Figure 12 – Other Potential Benefits

These results cover a narrower scope than is addressed by this research, but they are taken to be positive. There is an attitude of acceptance of wider use of synthetic environment techniques. Since the completion of the SimTE study, DES Ships has initiated the wider use of the SIF facilities to cover more of the lifecycle.

3.7.2 Lifecycle Test Issues

The test methods, lifecycle stages and complexity of testing can be combined into a 3-dimensional depiction as shown in Figure 13. The figure compares the needs of the CADMID cycle, the available test techniques and the complexity of testing demanded versus the tools categories available. These lifecycle considerations are reviewed from a different perspective in the next section, relating them to Systems Engineering.

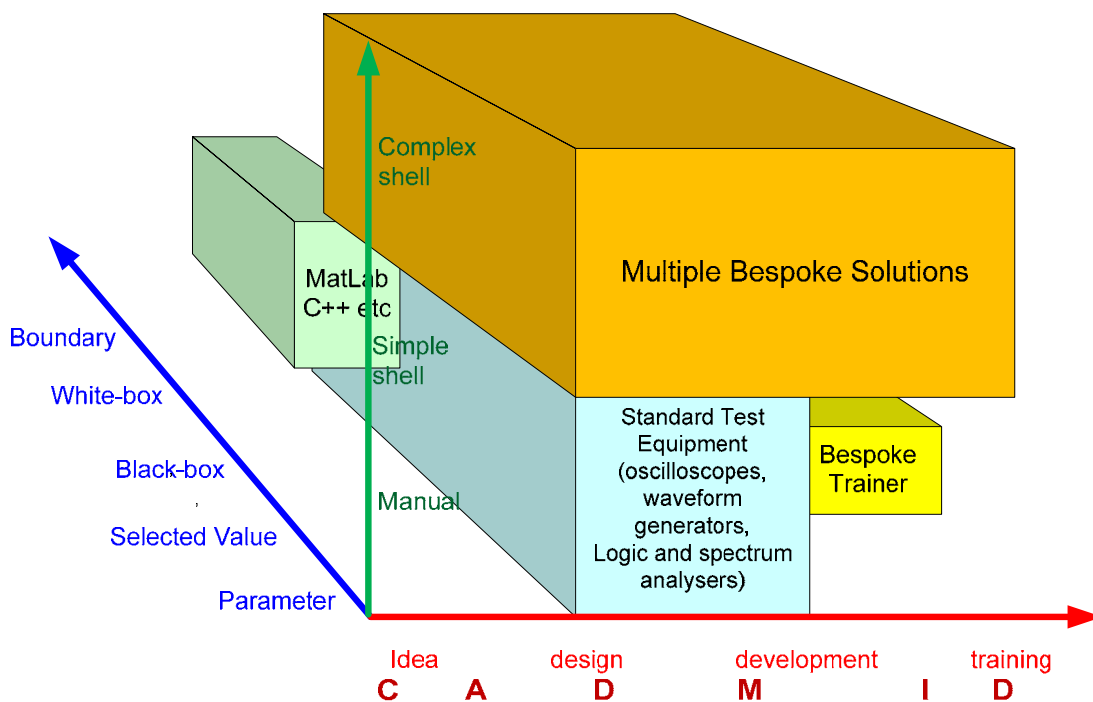

Figure 13 - Perspective of Testing Techniques and Lifecycle

3.7.3 Testing Techniques – Summary

The evidence is that a test-shell is a super-set of the testing configuration, a sub-set of it is in use by the military and it has a proven record. This was a foundation for the decision to use this construct in this research. It is extended to produce a generic variant that supports visualisation techniques as presented in section 4.2 and subsequent sections.

3.8 When to Test

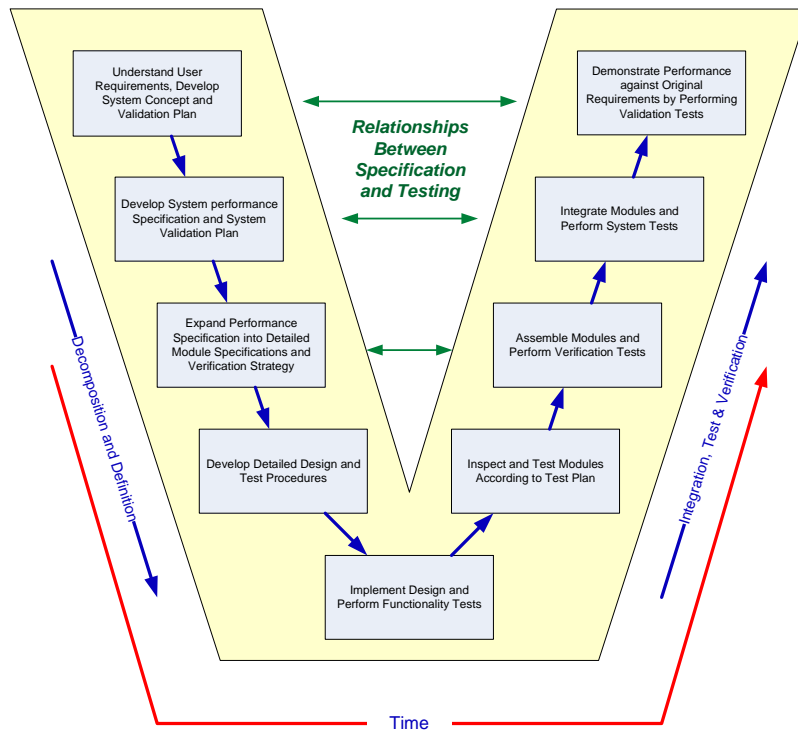

Figure 14 – Project 'V' Diagram

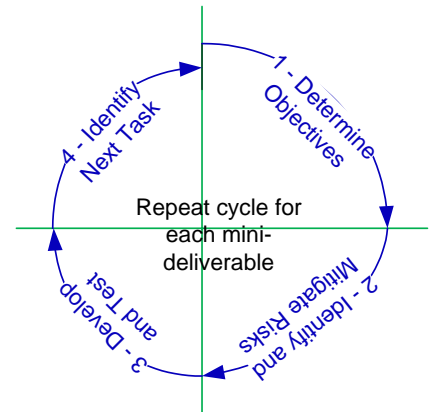

Figure 15 – Project Spiral Model

The project 'V' diagram [75] (see Figure 14), describes that a project's linear timeline flow (the waterfall model) can be conceptually 'bent in the middle' (to a 'V' shape) where the left arm is the design stage and the right arm shows the integration, test and verification activities. Attention is drawn, by proponents of this concept, to the relationships between the activities on each side of the V. The definition of what is required (top left) is mirrored by the system testing stage (top right) and so on down the 'V' model.

The lesson is that the right-hand side testing aspects should be considered and planned when undertaking the equivalent design activity. Because modelling can be undertaken to verify the design activities it is also possible to apply the planned tests when the modelling is being performed – during the CA stages of the CADMID cycle.

In a perfect test, the conditions of early and later tests would be identical. Furthermore, the tests would be consistent from the top of the 'V' to the bottom so that each component of the system can be shown to add its expected contribution to the final overall performance. At each stage, poorer

and better systems under test would each use the same available data to different effect i.e. the tests would be designed around the requirements, not the implementation of a solution to meet them. This is a keystone to this research. The aim is to re-create the environment without (undue) concern about how the data are used by equipments placed into it.

Challengers of this 'V' approach take the view that the steps are too big for projects that take longer than a few months, especially given the changes in technology that can occur in that time.

The Boehm alternative [76] is to define the general direction and then form small teams (2-5 people) to create a 'deliverable' that the customer can use, or identify with, after no more than a few weeks – see Figure 15. A User Interface (UI) might be an early deliverable so the user can see what the end-result might be like. Functionality and updates to the UI will follow according to a scheduled plan, modified by the learning process (evolution) of the design. This is often described as a spiral evolution because each step might utilise the 'V' process but there would be many cycles of it each spiralling to converge upon the final delivery. This concept helps to engage those who still believe that 'testing comes at the end' – there are many ends, hence many testing points. We can see in this some parallels with the Gray concept of moving from large projects to a series of phased deliveries. Arguably, this process produces less documentation but traceability is maintained, in practice the amount of documentation may be similar but is produced in smaller steps. A management process can be established for this working practice so each 'spiral' is launched, and its deliverables checked before the mini-task is 'signed-off'. The International Council on Systems Engineering (INCOSE) has undertaken much work in this area and produced a series of guides, including the Systems Engineering Handbook [77] to attempt a standardisation of approach.

3.8.1 Project Flow – Implications

It is worth re-stating the basic concept, it is important for this research. The 'V' model in Figure 14 shows us that in parallel with defining requirements,

the test to verify them should be specified. Much of the work at the early stage is done by simulation and modelling, so the tests intended for the later stages can be run on the simulations and models at these earlier stages. This is a useful way to develop and quantify a specification. The opportunity is one that should be taken and is considered to be an essential step that this research addresses. The context is more clearly seen from the spiral model that shows a discrete test phase at each stage of evolution.

It may be surprising that this aspect of ‘testing as you go’ is often overlooked, especially in the traditional implementation methods; T&V becomes a cost and timescale liability at the end of a project because of this. Gantt charts, against which Project Managers check progress, often do not include a test stage. The activities are considered by gut feel to be in a ‘red, amber or green’ status. Green means completed see Ch 4 of ‘The Portable MBA in Project Management’ [78]. The work by Loo reported in the ‘International Journal of Project Management’ [79] suggests that a factor is the orientation of the Project Manager between technical and personal bias in their approach to project and team control. Here we intend to merge these approaches.

Due to these misconceptions, whatever their underlying cause, Design Engineers are required to ‘divert their effort’ to this test activity thereby ‘reducing their productivity’ by the management measures that are often applied. It is a common misconception that the left arm of the ‘V’ will consume the most effort, the right arm is then under-resourced, the outcome being that deficiencies appear during Final Acceptance Testing. Rework is then needed and projects become late and overspent. The larger the project, the more that can go wrong in the right-hand arm activities. The NAO reports confirm that larger projects are at greater risk than small ones.

For the agile software lobby, the tests are inherent in the process and in the domain of the agile team. However, it is still possible to lose sight of the review process that decides the acceptability (or not) of each module. The spiral model itself does not include any system-level validation or verification. For this reason, to comply with customer requirements, a

project may be run with the ‘V’ model to retain the overall demonstration that needs have been met, but with elements being developed according to the spiral model.

INCOSE is attempting to change the approach that considers testing to reside in the final stages of a project. Where it resides and what it comprises are current stakeholder communications issues that have no winners. It will be remembered that the CO Air Warfare Centre is concerned that capability testing is not done effectively prior to delivery (section 2.4.1). The testing that has been undertaken is primarily concerned with ‘safety’. It is also a largely undocumented area with anecdotal evidence only; few organisations wish to declare such issues publicly.

3.8.2 T&E Key Points

A strong body of research and best practice is available defining lifecycle testing and the techniques to apply to achieve the type of results required. This research found no evidence that this is being applied consistently to the full lifecycle of MoD projects. This is discussed further in section 4.8.

There is evidence that good practice is applied separately during each of the CA and DM stages of lifecycles. Dstl and Industry, who undertake these stages, participate in the bodies that generate the best-practice standards. Join-up between stages is the main issue – see section 4.8. Projects that are more recent, of which the Type 45 Destroyer project is an example, have experienced some of the manufacturing stage support equipment percolating through to training or maintenance facilities, rather than being re-invented. This research aims to extend and standardise such reuse in the interests of risk reduction, cost reduction and improving delivery timescales. It is also hoped that continuity, particularly allowing users to be involved much earlier in the lifecycle, will improve the delivered benefits to the Armed Forces. The benefits, it is hoped, will derive from user feedback being available much earlier in the lifecycle so that the design objectives and practice become closer to the real needs of the users. The real needs are not always those specified in isolation from exposure to implementation reality.

3.9 Summary of Best Practice

This section reviews the previous and summarises the key points.

Commercial Instrument: There are 3 instruments available to the MoD when procuring equipment. They are designed for different purposes. However, within that constraint they offer different advantages and disadvantages to the MoD and industrial stakeholders. If possible, it would be useful to cross-fertilise the constructs to level out the pros and cons.

| Benefit Sought | Best Instrument |
|---|--|
| Delivery timescale | UOR |
| Cost and good commercial terms | Possibly PFI Possibly EPP |
| Rapid Technical Support | FATS |
| Service benefits shared components with other equipments Technological leading edge Interoperability Works on delivery - meaning all DLODs and KPMs met | EPP EPP EPP All need to be improved |

Table 14 - Contractual Instrument Best Practice

This research proposes a way to partition activities required for sensor system procurement in such a way as to improve performance by optimising the advantageous methods for the various partitions –see section 4.1.

PT Guidance and Systems Engineering: Guidance that is provided is arguably inappropriate for its readership. Visual presentation of military issues is a popular approach as evidenced by Niteworks and similar exercises. These are not linked to the MODAF presentation views. Finding a way to incorporate these techniques into project lifecycle issues would be likely to appeal to the military personnel expected to generate ITEAP documents and steer projects through their various stages. However, the current visualisation techniques do not cover the full lifecycle and provide one more type of discontinuity adding to those of tenure and stakeholder specialisation.

Specification and Measurement paper: is a very useful insight into the disparity of perception between the stakeholders. It offers simulation and modelling as a way forward to produce parametric specifications from the simulations. It hesitates about scenario dependency on the basis that these could focus on the boundaries of the requirement and the equipment would be exclusively designed to meet them. However, treating the scenarios as examples, that all stakeholders expect to vary, would help clarify the real requirements and reduce the tendency to 'specify to the edge of Physics' (Gray). Carefully handled, this would encourage a useful dialogue in which all stakeholders could engage. The concept of this paper can be extended to other sensor types. The stakeholder boundaries are useful in defining responsibilities. Ways to incorporate the stakeholders into a unified delivery team are proposed by this research.

Visualisation and Simulation currently does not extend to the full lifecycle, however it does have industrial and military buy-in in a way that the MoD is prepared to fund. Its current shortfall is simply its lifecycle restriction that excludes concept as well as software, hardware and man in the loop testing. This is because current visualisation techniques support only 'games', not real-world physics representations. A sub-set of this group includes terrain-mapping software that is attractive as a foundation for scenario visualisation.

Technical Software is available to support in-depth analysis and concept evaluation but this does not have the visual impact to be understood by all stakeholders. Its use is restricted to sections of the technical community. The rigour of such software needs to be retained but its comprehensibility improved. No evidence was found for existing joining-up of the reviewed specific technical tools with visualisation, however general tools, for example C and C++, do bridge this void for bespoke solutions.

Testing Techniques should apply to all stages of the lifecycle. A range of standard laboratory test equipment through to bespoke test equipment is available to support primarily 'DM' stages. A test-shell system offers the incorporation of scenarios and visualisation techniques, but it can be an

expensive option. The cost may not be as great as perceived if the true cost of assembling and verifying the alternatives at the various lifecycle stages, plus the cost of re-work due to misunderstandings, are taken into account. This research proposes a test-shell constructed in a way that minimises the project-specific aspects, so that re-use is inherent. This would reduce the total ownership costs by spreading the development costs over many current and future projects. It should be noted that ownership costs include original purchase, training and maintenance, all of which are minimised for commercial and re-usable products, compared to bespoke systems.

The Project ‘V’ model tells us that testing is part of all stages of a project, not just an activity in the final stages. To treat it that way leads to misunderstandings and re-work. Testing and verification should be part of the through-life management of a project. The spiral development model is useful in supporting micro-activities within the main ‘V’ model.

The next chapter uses these aspects and the commercial objectives reviewed in chapter 2, as anchor points upon which to construct a techno-commercial solution to meet the objectives.

4 Research Topics

Any solution must be capable of fitting into the procurement framework and processes that have evolved as described in Chapter 2. To adhere to best practice it should meet the criteria presented at the end of Chapter 3 in relation to:

- **Commercial constructs** – applies to the Enterprise solution (addressed in section 4.1).
- **The guidance provided for DE&S** –scopes their skills and identifies that ITEAP issues are an extension to them. Based upon the NAO reports (Chapter 2), there is opportunity to improve control of larger projects. (This is also addressed in section 4.1.)
- **The Specification and Measurement** work lays down some technical and communication challenges that are addressed by the proposed technical solution that is introduced in section 4.2.

The basis for the proposed solution is contained in the above. The rest of Chapter 3, modified by Chapter 2, contributes to the solution as described below, where the numbers relate to this section:

1. Section 4.3 illustrates the breadth of technical coverage required of the technical solution
2. Subsequent sections address the practicality of implementing the technical solution by using radar (section 4.4) and ESM (section 4.5) as examples.
3. Other sensor types are important but have not been covered in detail during this research. Section 4.6 compares the complexity and other issues of other sensor types with the radar and ESM examples chosen for further work as part of this research.
4. The scope of radar and ESM support is defined in Section 4.7 that summarises the parameters to be supported and sections 4.8 to 4.12.3 develop the generic solution and its application to radar and ESM.
5. Application of the generic solution to other sensors completes this Chapter in section 4.13.

4.1 Proposed T&E Enterprise Structure

Unless some form of organisational accommodation can be found, the technical aspects will not be implemented. Taking the holistic view of the issues, this section is important in presenting a proposed enterprise structure, shown in Figure 16, to fit into the MoD's Procurement operations. Failure to incorporate this aspect would negate the author's intention to undertake EngD research, with commercial viability. The enterprise structure is designed to meet the following needs:

- Prime contractors to produce the main equipments (status quo)
- SME and Academia to contribute 25% of project value [80] para 193
- T&E to be independent of design and implementation (good practice)
- Assisting the Procurement Executive in addressing technical issues given their reduced numbers and minimal technical expertise
- Addressing the Gray report observation that 'the UOR process delivers capability more effectively than the standard EPP' [81] sect 7.6 p 134
- Addressing the NAO reports on Major Projects that indicates that performance on smaller projects is better than larger ones
- Addressing the work done in this research to extend the two above (section 3.1.1.1 page 76)

It also takes into account the Systems Engineering aspects reviewed in the previous sections. The proposal aims to support the project V model whilst accommodating spiral development within it. In this respect, it can be considered to support a series of small projects that are unified to produce a scalable larger project. This will improve the projects' chance of success. Unification applies not only to the CADMID issues but offers assessment of deliverables in terms of their capability, when used with the test-shell described in the next section.

Also of importance, and addressed here, are the comments collected during various interviews as described in section 2.4. They included a number of ways of interpreting the rules in such a way as to meet secondary project criteria. For example, delivery of equipment but with training or other

DLODs sacrificed in the process. The approach proposed here is designed to move such practices from the shadows into the light, where they can be assessed by all stakeholders as they occur.

Figure 16, below, is explained in the following pages.

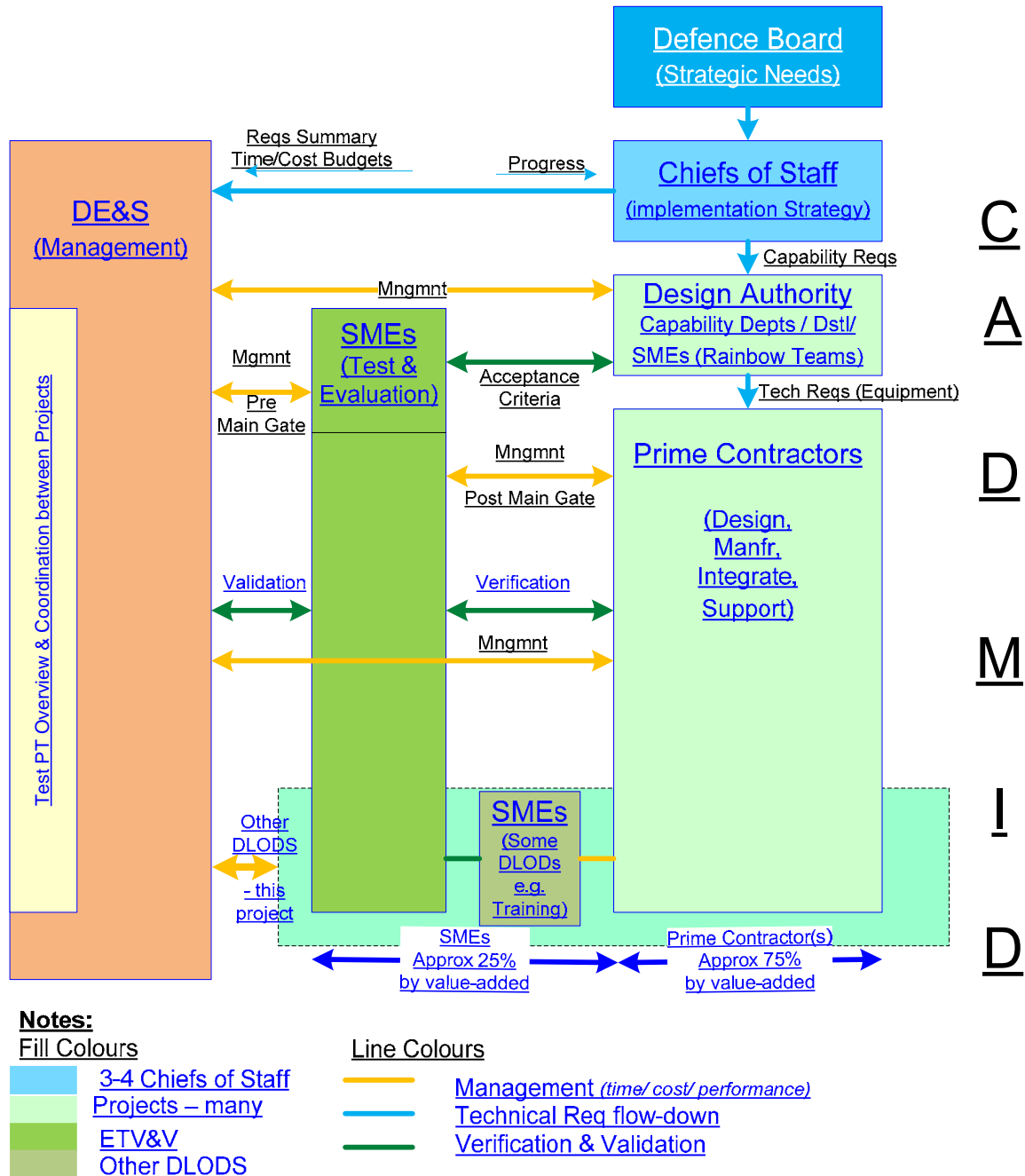

Figure 16 – Proposed Structure to Meet T&E Needs

4.1.1 Overview

The roles of the Defence Board Chiefs of Staff and the Design Authority (see Figure 16) comply with the Gray-Levene definitions. The DE&S role stays management focussed. The middle-lower parts of the diagram show the prime contractor and 'DMI' activities of the CADMID cycle. Alongside this, but separated, is a Test and Evaluation role fulfilled by SMEs.

The first part of the T&E stage being during the CA parts of the CADMID cycle, examples of the issues to be addressed at this stage were highlighted in the Specification of Radar work, section 3.4, and the second part during the other lifecycle stages. The MoD's FATS instruments would be appropriate for funding the CA stages, where the outcome and time are not readily estimated. An EPP contract would be suitable for the main stage, possibly moving to PFI for the 'I' stage of CADMID.

This structure is intended to:

1. Link responsibilities and authorities
 - a. rationalise the DE&S management role by minimising links
 - b. maximise benefits to all of Cap, prime and SME key skills
 - c. provide clear lines of communication
2. allow skills to be naturally used where they lie rather than forcing players to gain new skills e.g. within DE&S
3. Utilise the Design Authority visibility of other projects and legacy systems to
 - a. fulfil their system of systems architectural (SOSA) responsibility
 - b. specify Open Systems where applicable
4. Separate responsibility for the T&E role to monitor all requirements throughout the lifecycle. Their reporting to DE&S, for onward formal reporting to the Design Authority, to include a set of agreed metrics (including timescale and cost performance). This is done for airframe

design, weapons and nuclear procurement as specified by the ITEAP requirements on the AOF website [52]. It would seem to be illogical not to extend the concept to other areas if it works in these cases where there are obvious high risk and health and safety issues.

The proposed responsibilities are expanded in the next section as a starting point for proposed structure. More work is needed with a stakeholder group, of which the MoD clearly plays a major part, to develop the concept into a working structure. Initial discussions at Chiefs of Staff and Cap level have been guardedly positive and the work continues.

4.1.2 Responsibilities

| DLOD | Delivered by |
|---|---|
| Training – having people known how to use the equipment | SME |
| Equipment – the equipment itself | Prime/ SME |
| Personnel – <i>provision of appropriate numbers of suitable people</i> | Civilian needs managed by DE&S |
| Information – understanding what the equipment will provide | Design Authority |
| Concepts and Doctrine – what it’s likely to be used for | Chiefs/ Design Authority |
| Organisation – <i>support needed</i> | Civilian needs managed by DE&S |
| Infrastructure – <i>the necessary support buildings, platforms etc</i> | Civilian needs managed by DE&S |
| Logistics – <i>the ability to support and maintain it</i> | Civilian needs managed by DE&S |
| Interoperability – to meet the needs of an integrated system | Design Authority |

Table 15 – Proposed DLOD Delivery Responsibilities

The 9 DLODS, represented by the dotted box in Figure 16, would be delivered by the bodies shown in Table 15. The concept draws upon the Levene and Gray Reports described previously and adds the responsibilities of primes and SMEs

The structure shown in Figure 16 is mainly intended for equipment DLOD delivery, specifically sensor related equipment. Delivery of other services

needed by the Defence Chiefs (Army, Navy, Air, Joint) may follow a similar or different route and be managed by DE&S as appropriate i.e. to cover civilian parts where procurement is involved.

The structure shows the T&E role being undertaken by SMEs. There are alternatives but each presents problems that are likely to be greater than using SMEs in this role. If another Prime Contractor takes this role, they would have access to the intellectual property belonging to another prime contractor. This would be totally unacceptable because the T&E prime contractor would have the infrastructure to use any new concepts in the market, thereby competing with the originator. This would not apply to an SME organisation. Dstl would be able to fulfil this role but it is not part of their remit to do so. Further, they do not undertake work that can be undertaken by industry. This leaves few choices. However, choosing an SME construct

1. brings to bear the specialist expertise of the SME
2. helps to meet the government's target that 25% of contract value should go to SMEs (Luff Report [82] para 193).

4.1.3 Operation of the structure:

- 1 DE&S perform a management role with a single contract to a prime contractor.
- 2 The Design Authority will be a Cap heading a rainbow team comprising other Cap personnel, Dstl and SMEs (Subject matter Experts some of whom may also be small- medium enterprises or academia). The Design Authority works to produce a specification. Their budgets and timescales are managed by DE&S.
- 3 The main design, integration and support functions will be performed by the prime
- 4 Evaluation and test are separated from the design function.
- 5 T&E starts early in the lifecycle with the intention of assisting with evaluation of options, supporting specification by scenario generation

(thereby defining acceptance criteria in a manner to which all stakeholder can relate)

- 6 This is akin to DE&S 'friend' role mixed with a light shade of the very old construct of having MoD inspectors on prime sites.
- 7 The T&E function works with the prime to verify that the stages of design/ manfr/ integration are each aligned to the original (or agreed change) needs. They report independently to DE&S with the level of validation to which the intent for military capability is being met (not just the compliance with the spec – hence the need for early involvement)
- 8 Some DLOD deliveries are also separated, where skills other than the main delivery skills are required. Training provision is an obvious one.
- 9 Note that the mix of prime/SME involvement should fall-out to its natural level and be measured not by cost but value-added (criteria to be defined with all stakeholders including the Military and to take into account the cost of failure resulting in inadequate deliveries). DE&S will be responsible for monitoring that value-added bears a justifiable relationship to cost. The intent is to aim towards a 75%-25% mix.

The SME role could take the form of a consortium of companies formed for each contract. The equipment they require may be procured under a GOCO (Government Owned and Commercially Operated) arrangement so that the T&E assets remain the property of the MoD with the labour content sub-contracted as appropriate to needs.

It would be important that the SME team did not 'go native' i.e. adopt the approach and practices of their prime partner. This objective could be met by rotating SME operators of a 'common' T&E asset (such as defined by this research) between applications and the associated prime contractors.

4.1.4 Outcome so far

This principle has been discussed with Head of Capability CapJTES (Capability for Joint Test, Evaluation and Simulation) and the Chief of Air Staff. ADS, arguably the main trade body for the aerospace industry, are representing this concept and enterprise proposal to the MoD at the highest level in order to add some gravitas to a few SME voices. The concept has not

met with any objections. The discussion is around meeting specific departmental issues as they arise– a normal stakeholder negotiation that is not short-term and is on going. However, the fact that it has survived serious consideration from senior people over a 2-year period is a positive outcome in itself. Further, the recent adoption of the concept by ADS is another positive step.

4.2 Proposed T&E Technical Solution

The rest of this chapter describes the architecture and system design of a test-shell as described at the beginning of this chapter.

The concept brings together the findings of the testing and visualisation techniques. Section 3.7.3, that summarises testing techniques, introduces the test-shell option. Section 3.6.1 fails to find a clear visualisation technique that meets the criteria for merging games options with physics based testing techniques, but Google Earth is identified as a tool that offers advantages in terrain mapping.

The merged facility proposes scenarios generated to run on Google Earth. These will help to demonstrate the required capability advantages that the military wish to achieve. The display will be driven by a test shell that supports the Google Earth visualisation of deployment of the sensor platform and various targets. The sensor platform may carry one or more sensors – the deliverable to be tested and evaluated at all stages of its lifecycle. The test-shell is also required to create the environmental conditions encountered in the Google Earth selected area. Specifically, these will include the signals required by the sensor(s) on the platform.

The signal requirements are generated from an appreciation of the issues faced by the sensor domain specialists to whom the author of this research owes a great debt for the patience shown in discussing the finer (and not so fine!) points of importance to their work. Without their help, this would not have been possible.

The test-shell is required to support many sensor types covering the electromagnetic and acoustic spectra. The electromagnetic spectrum is discussed in the next section. For practical reasons it was necessary to restrict the sensor support to a few of those it is intended to support.

Radar and ESM were selected as sensor types to develop and evaluate the concept. The radar domain particularly was estimated to be one of the most difficult in terms of processing demands and rate of data delivery. Arguably, sonar would be at least equally complex. During the period of this research, radar was of more interest to the military community than sonar. Radar was therefore selected for commercial reasons. ESM stimulation offers an additional challenge to that of radar, namely the need to drive many RF generators in parallel for an ESM full system stimulation to be achieved. This aspect was considered during the research period but was not physically implemented for two reasons:

1. The cost of the generators was prohibitive for this research
2. A way was found to inject data at a later stage of the ESM processing equipment used for the verification of the test shell ESM capability

The purpose of the development work undertaken was to address the issues raised by the domain specialists and to show that they could be successfully overcome. The following are a précis of the challenging comments:

- “It is likely to be impractical to provide sufficient fidelity to support one (radar) application fully, never mind a range of them”
- “the speed of processing required will mean that serious constraints will need to be applied to algorithmic implementations”
- “interfacing with the real equipment will prove difficult”
- “when we have tried something like this in the past it didn’t work”
- “we spent over £1M with an American company to provide less than this, and were disappointed – it is unlikely that this objective can be achieved in a cost effective way”

Fortunately, advances have been made in processing capability over recent years. Furthermore, the author and sponsoring company specialise in

providing leading-edge (bespoke) technological solutions in the real-time sensor domain.

The work presented here is that of the author. The author, however, did not undertake the necessary coding of PCs or FPGAs needed to achieve the working system. The design, monitoring and control of these activities were the responsibility of the author.

4.2.1 Specifications and Confidentiality

It is not pragmatic for suppliers of military equipment to publish fully detailed specifications. Only specifications available in the public domain are referenced in this research, although the sponsoring company may have access to more detailed information that was used in the design. Consequently, the specifications in the next sections, describing radar and other equipments, do not necessarily reflect the full capability of any of the specified equipments, or any others that have been encountered by sponsoring company.

This research is intended to provide a basis to meet not only current needs, but also those of the next 20 years or so. The interpretation of needs, based upon those specifications that can be obtained, is deliberately intended to be liberal to cope with future requirements and should not be interpreted as indicative of the performance of any existing equipment.

4.3 Spectrum Usage

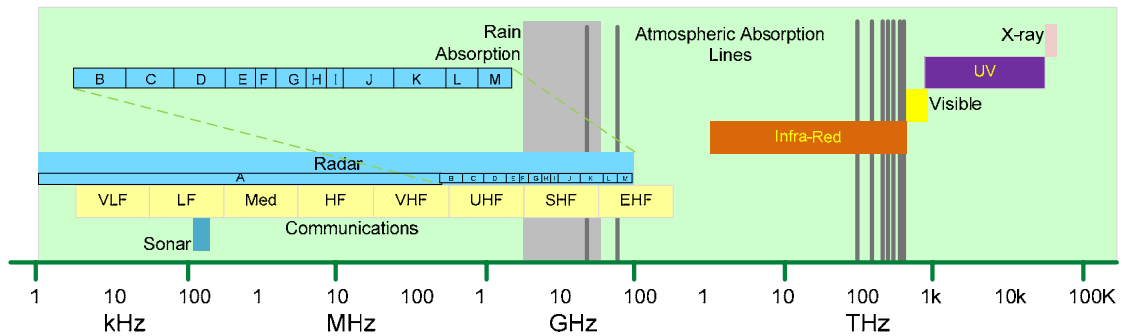

Figure 17 - Frequency Spectrum Usage

The frequency spectrum, based upon several sources including a policy document for sharing the spectrum, produced by the Combined Communication-Electronics Board (CCEB) [83], and a website produced by Texas University [84], is depicted in Figure 17. The figure shows the use by communications, sonar, radar, IR, visible UV and X-ray emissions, these are individually coloured and labelled. Rain and atmospheric gases cause absorption and attenuation in some frequency bands as shown. The nomenclature used in the diagram is the current NATO designation of bands. The relationship between these and those used prior to the change is shown in Table 16, clearly care needs to be taken when making reference to ‘L’ and ‘C’-Bands as they imply different frequencies in the two systems, ‘K’-band is also different but more closely related between the two systems.

This research potentially includes sensor systems that cover the whole spectrum. The work has concentrated on the communications and radar bands, with passing reference to sensors that utilise the very low-end of the RF spectrum and high-end IR, visible and UV parts of the spectrum.

| | | | | | | | | | | | | |
|-----|------|-----|---|---|---|---|----|----|----|-----|---|---|
| Old | | | L | S | C | X | Ku | K | Ka | Q | W | |
| New | B | C | D | E | F | G | H | I | J | K | L | M |
| | 0.25 | 0.5 | 1 | 2 | 4 | 6 | 10 | 20 | 40 | 100 | | |
| | GHz | | | | | | | | | | | |

Table 16 - Old vs. New Radar Band Nomenclature

The following sections each identify parameters that are of importance to test equipment intended to stimulate multi-sensor systems. Many parameters are important to more than one application but, to avoid tedious repetition, are not repeatedly identified. The parameters needed for inclusion in a test-equipment are, therefore, the logical 'OR' of those identified in the following sections.

4.4 Radar

Radar is an active sensor; it relies on the response of objects to energy propagated into the environment. The objects reflect some of the transmitted energy from items of interest (targets) and reflecting surfaces that are not of direct interest (clutter). Separating targets from clutter is a major function of radar receiving equipment. The atmosphere attenuates (absorbs) and refracts returns according to water content for example, as shown in Figure 17. A test environment must faithfully replicate both energy reflection sources for it to be of significant value, atmospheric effects may be of importance when considering 'edge-effects', those conditions at the edge of performance of a particular radar in range and energy levels.

This research considers applications of radar equipment installed upon the platforms shown in Table 17:

| Application | Maritime | Air | Ground | Missile | Satellite |
|--------------------|-----------------|------------|---------------|----------------|------------------|
| Detection | yes | yes | yes | yes | |
| Tracking | yes | yes | yes | yes | |
| Identification | yes | yes | yes | no | (imaging) |
| Surveillance | yes | yes | yes | no | yes |
| Navigation | yes | yes | yes | no | |
| Combat | yes | yes | yes | no | |

Table 17 - Radar Applications and Functions Considered

Appendix G presents the detail of the radar requirements in these areas, they are summarised in the next section.

4.4.1 Radar Requirements of a Test-Shell

| Parameter | Maritime | Air | Weather | Military |
|-----------------------------------|-----------------|------------|----------------|-----------------|
| Range resolution | yes | yes | | yes |
| Range accuracy | yes | yes | | yes |
| Range discrimination | yes | yes | | yes |
| Bearing resolution | yes | yes | | yes |
| Bearing accuracy | yes | yes | | yes |
| Bearing discrimination | yes | yes | | yes |
| Altitude resolution | no | no | | yes |
| Altitude accuracy | no | no | | yes |
| Altitude discrimination | no | no | | yes |
| Plot Extraction | yes | yes | | yes |
| Clutter performance | yes | | | yes |
| Weather performance | yes | | yes | yes |
| Jammer performance | | | | yes |
| Integration with secondary radars | | yes | | |

Table 18 - Target Parameter Importance to Radar Types

In 2007 Ofcom, the UK's regulator for telecommunications, commissioned QinetiQ to undertake a study into band-sharing issues that might affect the performance of S-band radars [85]. The study considered maritime navigation and ship control radars, air-traffic control radars, military radars and weather radars. Importantly, the study identified key radar parameters that the report investigated as being important to the correct operation of the radars. These parameters, that clearly need to be faithfully replicated in a test system, are presented in Table 18. Failure to follow these criteria may affect the spectrum in ways that only become apparent when the equipment is used in the real world. Interference may be caused by the radar, or the radar may be more susceptible to interference from other sources.

The parameters listed in Table 19 were listed as important but not assessed in the Ofcom report regarding radar types

| Parameter | Relevance |
|--|---------------------------------------|
| Doppler accuracy | Not stated |
| Swerling target fluctuation model | To probability of Detection (P_d) |
| Variation in propagation factor to target | A weather performance factor (above) |
| Variation in propagation factor to interference source | A weather performance factor (above) |
| Variation in target RCS | To P_d (Probability of Detection) |
| Variation in clutter | To P_d |
| Variation in radar transmit power | To P_d |
| Variation in radar noise figure | To P_d |
| Variation in receiver gain | To P_d |
| Variation in interference source power and spectrum | To P_d |

Table 19 - Other Relevant Platform-Target Parameters

4.5 ESM

Electronic Support (or Surveillance) Measures (ESM) comprise a family of passive sensor systems. They are used to monitor RF signals, deduce the direction from which the signals emanated and what may have generated them. The frequency, modulation type and duration are typical parameters that are used to identify the possible source. The signals can usually be identified as being radar (high frequency with an identifiable repetition frequency and pulse-width) or communication (usually lower frequency with longer pulse width and variable or no repetition frequency). There are cases where the identification cannot be made with 100% confidence; other cases may involve multiple purpose signals such as radar with embedded communications.

The presence of an ESM monitoring system cannot be positively identified by a hostile force because it is passive. An ESM capability can be assumed when a military platform is identified. However, in order to achieve covert intelligence gathering, ESM equipment may be fitted to non-military platforms, there are also land-based monitoring sites. ESM offers a covert way to collect intelligence.

Communications equipment has frequency coverage as shown in Figure 17 on page 121. The modulation types can be any of the possible types (amplitude, frequency, and phase, single or double sideband with or without suppressed carrier) or combinations of them. The carrier frequencies may be agile to the extent of being different for each transmission burst or changing during transmission (spread-spectrum types). RF altimeters are radar-type devices; they transmit pulses, typically in the G, H or K-bands, with power of a few Watts vertically downwards and monitor the time of the return signal to establish altitude. Satellite communications systems can also be directional, particularly for military applications. Taking steps to reduce the number of emissions and minimise the power and transmission time of those emissions that are needed, makes them more difficult to detect and minimises their detection range.

Although the range of parameters that can be monitored are obvious (any feature of the transmission), the resolution and accuracy with which they can be identified vary from one system to another, and are of a military-confidential nature. There are a number of reporting formats delivered by ESM receivers, the formats are designated UAP; UAT1 and 2; UUA4 and similar. The formats include a definition of reported resolutions and accuracies and are on a 'need-to-know' basis i.e. the information is only made available to those who need the information for a military approved purpose.

The equation relating the returned power from an ESM signal source is provided in section 4.9.2.3.

Relevance an ESM test facility can be called upon to do the following:

1. generate any of the possible modulation types at a wide range of frequencies and powers
2. vary the transmission periods and durations
3. support a flexible reporting system to cover UAP/ UAT etc

4.6 Other Sensor Systems

Other sensor types of relevance to this research include sonar, IR, visible and UV based equipment. They are not covered in detail but are considered as extensions to this work.

However, some simplified equations have been researched and are of a similar complexity to the radar equation, implying that they can be implemented by similar processing techniques to those developed for radar data processing.

4.7 Summary of Relevant Radar & ESM Parameters

Our interest is in the signals received by the sensors on the platform. The relevant parameters can be summarised into groups that will be expanded in the next section. In the following, ‘platform’ means a ship, aircraft, etc. that is carrying the military sensors of interest. A ‘target’ is generally another platform that may be friendly, hostile or neutral. Some parameters are static; the physical size of a target is an example. Other parameters are dynamic; these include positions of the platform and targets. The dynamic parameters are identified in the following groupings.

1. Platform Sensor Data Capability
 - a. Radar capability
 - i. Selectable power, frequency, PRF, PW, waveform
 - ii. Selectable beam gains, shape, pointing direction
 - iii. Antenna location – relative to centre of platform
 - b. ESM capability
 - i. Frequency coverage
 - ii. Beam shape relative to platform geometry
 - iii. Data reporting formats (UAP; UAT etc)
2. Target Capability (per target)
 - a. Speed, acceleration capabilities
 - b. Size (length, height, width, centre of mass)
 - c. Radar Parameters
 - i. RCS – 3-D spatially distributed radar reflectors in aspects of interest as a minimum
 - ii. Amplitude, phase response and physical size of each RCS point
 - iii. Countermeasures
 1. Type (passive/ active + active type)
3. ESM Parameters
 - a. RF equipment carried (to provide range of frequencies, powers etc. that could be emitted)
 - b. Current emissions - frequencies, powers, modulation types, radiation directions and beam shapes
4. Other Sensor Parameters
 - a. Not covered here
5. Location Data (generally fixed)
 - a. Geography of area in which the platform and targets are located

- b. Weather conditions in which the platform and targets are located
- c. Fixed Jammers
 - i. latitude, longitude, altitude
 - ii. emission types & trigger conditions
- 6. Dynamic Parameters (for each target)
 - a. Physical
 - i. Current latitude/longitude/altitude of platform and each target
 - ii. Current direction, speed and (3-D) accelerations of platform and all targets
 - iii. Active fixed-location jammers
 - iv. Weather features (rain, wind, ocean currents and tides)
 - b. Radar
 - i. Current frequency; PRF; PW; power; beam shape; beam pointing angle
 - ii. Active jammers or other countermeasures
 - c. ESM
 - i. Current monitoring frequencies and beam angles (may be all available)
 - d. Other Sensors
 - i. Not included here

4.8 Modelling and Synthetic Environments

The parameters identified in the previous section can be used to define an instantaneous snapshot of a radar/ESM situation in a geographical location. This includes the positions of all targets and the platform that is carrying the sensors, as well as their RF activity. The sensors are the part to be tested and will be referred to as the Unit-Under-Test (UUT) in the following. The RF activity includes which targets are emitting which frequencies, at what powers and in which directions. It also defines the frequencies and directions being monitored by the sensors on the platform at each time instant. The relative locations of the platform and targets, plus weather and geographic conditions (hills etc.) will also affect the platform's ability to receive signals and these are taken into account by the test-shell.

The ability to define a snapshot at any instant can be extended to producing a series of snapshots over a time-period so that a 'scenario' can be defined. A scenario is a sequence of events involving the movements of platform and targets in a geographic area, in defined weather conditions, with defined RF activities on the targets and platforms. Scenarios are also called 'vignettes' in some applications. Military situations can be defined in this way to identify issues with existing equipment. The following is an example of how a scenario for investigation of military capability might be initiated; it is intended as an example only, representing a possible military perception:

During the Falklands campaign, military ships were anchored in San Carlos Water, an inlet surrounded by hills. Argentinean operated Super Étendard jet fighters were able to approach undetected at low level, screened by the hills. During the resulting combat, the jets were able to use the hills as a screen between making attack runs. Following one attack by sea-skimming Exocet missiles, HMS Sheffield was sunk and sailors were killed and injured. What could be done to avoid a repeat of this situation?

It can be seen that, given the parameters defined in the previous section, such a qualitative description can be set-up as a quantitative scenario. If a suitable model were available, it would be possible to modify radar parameters on the platform (HMS Sheffield) to explore 'what-if' scenarios to

answer the question in a quantitative way. The resulting parameter set would form the basis of a specification for any modifications to resolve the issue. Furthermore, if the modelling could produce signals in real-time, it would be possible to retain this scenario at each stage of design, development, testing and initial trials to ensure that the expected results were being achieved at each stage of the lifecycle. Furthermore, the modelled scenario could then be used to train sailors to operate the new/modified equipment. This would contribute to avoiding the situation recurring.

This concept is depicted in Figure 18 where the small picture at the bottom left shows a visual image of the scenario. Strictly, this is a Synthetic Environment (SE) not a model. An SE comprises many models, in our case targets, environment, clutter etc. The SE term will be used in this sense in the rest of this thesis.

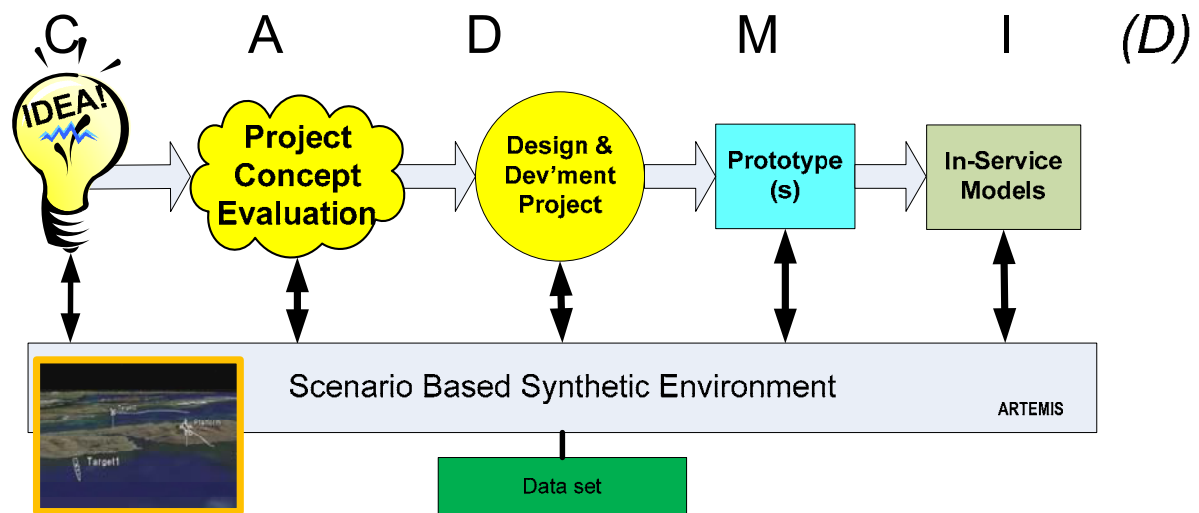

Figure 18 - Concept of Unified Specification and Testing

This concept is novel, the current techniques are akin to that depicted in Figure 19 where the test equipment is developed for each stage of the lifecycle and the specification is restricted to a written document.

In the traditional approach, models specific to each stage of each application are often used. A re-useable SE removes the cost and timescale needed to produce a verified validated working system although it does incur greater initial cost to produce.

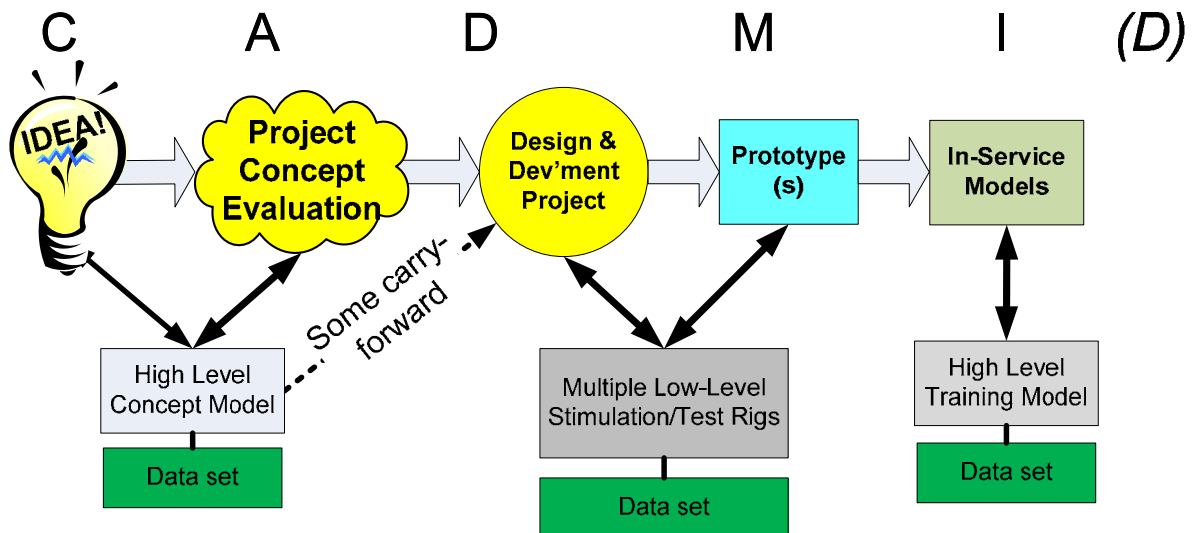

Figure 19 - Current Techniques – showing discontinuities

The outputs from the SE can be used to stimulate the new/modified radar in real-time. A test shell, incorporating the SE could also monitor the radar’s response to the stimuli to provide, for example, a quantifiable detection event. This construct is shown in Figure 20 that also shows the scenario in a visual form.

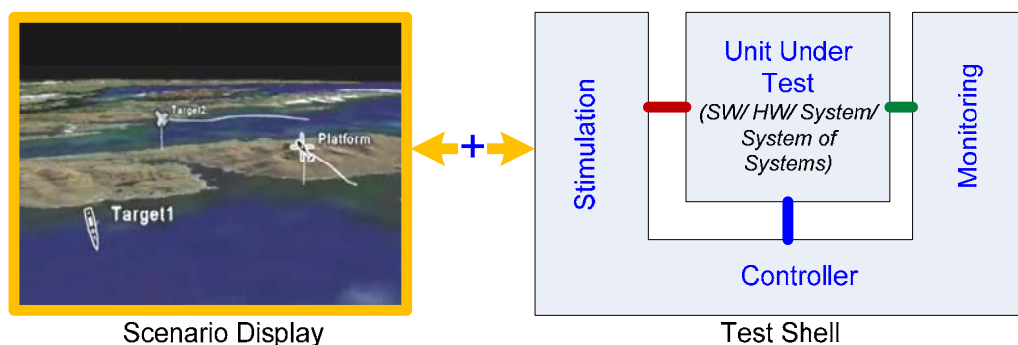

Figure 20 – The Concept Presented as a Test Shell

The main advantage of presenting a visual depiction of the scenario as it unfolds over time is that it is a powerful enabler for effective communication between the disparate stakeholders. The stakeholders’ backgrounds include military personnel, as described previously. They need to communicate with

DE&S project managers as well as Dstl scientists and analysts who are likely to assist with the preparation of a specification. Later in the lifecycle industrial project managers, project leaders, engineers and designers from several disciplines (hardware, software mechanical engineering, safety specialist etc.) will be involved. Test and integration specialists as well as trials personnel and training specialists will add their contribution in order to deliver the DLODS to meet the specification. Chapters 2 and 3 of this thesis explored the difficulties surrounding finding a common language to communicate between these disciplines.

The purpose of the following section is to describe how a software suite can be designed to meet the needs pertaining to this research. The objective here is to convey system level understanding, not detailed implementation. The system level work is that of the author whereas implementation of sufficient of the architecture to validate the intent was largely undertaken by a graduate student assisted by sponsoring company personnel. More work is required to implement the design fully.

4.9 Structure of a Suitable Synthetic Environment

The headings in the list in section 4.7 can be used as a starting point to define a suitable SE. These can be re-constructed to show that the SE has a basic configuration as shown by the UML static class view, shown later in this section (Figure 21).

UML is a methodology to represent object-orientated software and is administered by the Object Management Group (OMG), a non-profit making organisation that controls the product's evolution and specifications [86]. The UML process includes many 'views' of a system, of which the static view is one and a sequence diagram is another. When an object-orientated program is started, the classes are called to instantiate objects that subsequently interact according to a dynamic view shown in a sequence diagram. A class comprises parameters and methods, the first are generally fixed values, methods define the capability of the class. Objects may be destroyed as the program progresses, or they may be retained for the duration of the program's operation, in which case they are declared 'persistent'. The classes described later are used to create persistent objects. However, lower-level classes are used to perform functions that are too detailed to describe here, for example checking status of internal memory. These objects are created as needed, then destroyed to prevent the system from becoming too cumbersome and littered with code that is seldom used. UML and object orientated technique are well known by software engineers and are well documented, this very brief explanation was included for completeness.

Figure 21 is a static diagram from the UML set, representing the top-level elements of a synthetic environment that is suitable for the purposes of this research. The figure shows a Scenario Generator class that is launched when the synthetic environment is started. There is a data set associated with the Scenario Generator's launch (not shown in Figure 21 in order to keep the figure clear) and this defines the parameters of the scenario, there being a different data set for each scenario.

The parameters include which targets are used (e.g. from a library of targets), their start locations, and how their speed and accelerations change as the scenario unfolds in time. The starting position of the platform and other operational parameters are also defined. The two main sets of non-sensor specific data associated with the synthetic environment shown in Figure 21 are ‘Vehicle’ and ‘Location’. ‘Vehicle’ handles issues relating to the sensor platform and targets, including sensor performance (our main area of concern). ‘Location’ handles issues relating to the environment. The Scenario Generator uses its scenario data file to instantiate as many ‘Vehicle’ and ‘Location’ objects as are required to run the scenario. The line across the middle of the diagram helps to delineate the general and sensor parts of the environment.

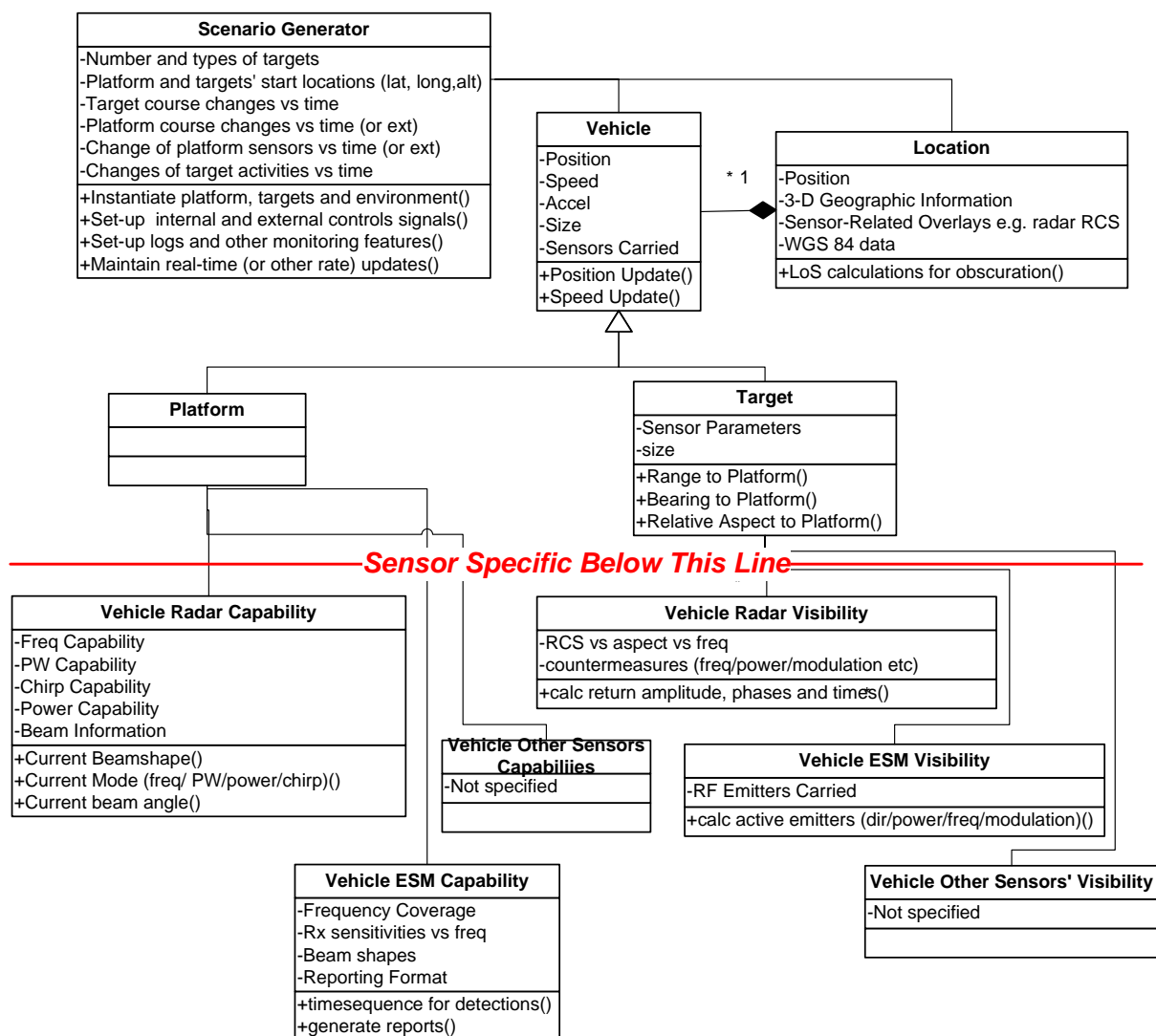

Figure 21 - Synthetic Environment Top-Level Class Diagram

4.9.1 General Elements

The general parts of the environment comprise those aspects of the platform, the targets and terrain not associated with sensors. Vehicle motion is a main one of these.

The vehicle class properties include position, speed and identifiers for its associated sensors. It also has methods to update its position and speed. The platform and target objects are derived from this class. Each target has the responsibility to calculate its own speed, position and its position relative to the platform.

The equations and their use in this application are described in Appendix H.

Given the speed and true heading of all moving objects, the relative radial speeds between the platform and each target can be calculated. These are needed for later calculations that relate to phase differences between them.

These, and other useful navigational formulae, can be found in the Aviation Formulary by Ed Williams [87].

The proposed approach devolves some calculation to the target objects and spreads the processing load. This is described further in section 4.9.3 (page 144) where the dynamics of the systems are presented.

Verification of Implementation: The implementation of these equations was verified by a series of tests during which the equations were applied over simple movements, for example to calculate the time to travel between two geographic points at fixed speed, for which manual calculation could be applied. Tests that are more complex followed, for example accelerating away from a geographic location for a fixed time, then reversing the acceleration for the same time and checking that the mid-point was the expected location and the end-point (zero velocity) was the same as the start point. Circumnavigation was used to check for the possible existence of cumulative errors in the calculations; the criterion being that starting point

should be crossed after each revolution during this test. Further information about verification of these issues is presented in Appendices I.2 to I.4.

4.9.1.1 *Location*

The Location class is responsible for providing information about the terrain in the area specified for each scenario's location in the world. This class incorporates a WGS 84 spherical Earth model (that uses the centre of the earth as its reference point [88]) with embedded 3-D geographical features. It is provided with a method to generate line of sight (LoS) information between any two points in its 3-D space. The class is required to overlay environmental information about the type of terrain. The type of terrain allows basic radar clutter, background IR and UV responses to be derived, for example for sea, forest and similar generic areas.

The algorithms for detecting LoS conditions can be applied sequentially, the first pass produces an 'OK' signal if the slant range is short and both the target and platform are high relative to the range of heights detected in the operational geographic area. As the range increases and the heights decrease, more steps are required to determine the LoS path in relation to the altitude information.

4.9.1.2 *Visual Scenario Generation*

The construct described provides a basis for locating vehicles (a platform and multiple targets) in a geographic space and calculating where they are relative to each other. This includes range, bearing, and aspect angles of the target relative to the platform; it also provides information about obscuration and background clutter levels for each sensor type. This delivers the basis for the visualisation aspects described earlier where the platform and targets move relative to each other to describe the operational scenario. The parameters described here utilise the static and dynamic position parameters identified in Section 4.7 list numbers 2a; 5a; 6a i and 6a ii.

Visualisation: The equations of motion define the locations of each vehicle that are then used to present the information visually. Google Earth is a popular and low-cost earth display program. Many people use the program and so associate readily it with geographic scenarios of the type proposed here. This led to its selection as a visualisation mechanism. Other mapping systems could be used, including the Digital Terrain Elevation Data (DTED) [89] that is a mapping data set popular for military applications.

The first part of the objective, being able to provide a visual interpretation of what is required, was met by these techniques. It remains to generate the signals, to which each of the platform sensors would be subjected, given these scenarios.

4.9.2 Sensor Issues – Radar

This section deals with radar sensor aspects that need to be supported by the test-shell.

4.9.2.1 Radar Range and RCS issues

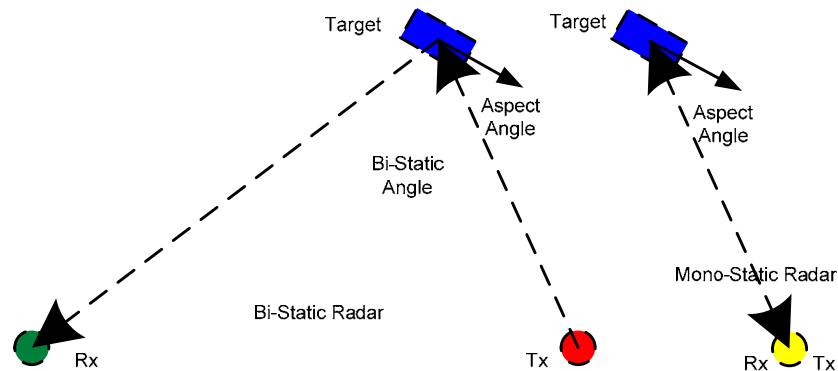

Figure 22 - Bi Static and Monostatic Views

The radar signal path-length is equal to the distance between the illuminating radar and the target plus the distance between the target and the receiving radar. In the case of monostatic radar, these are the same and so the signal path-length is twice the range. The ranges are not necessarily the same in the case of bistatic radar (see Figure 22). The aspect of a target is the angle that the target's axis presents to the line joining the platform and target. It will be appreciated that, for all targets other than spheres, the radar cross section and its visual (EO/IR) appearance changes with aspect. For a bistatic case, the reflecting points may not be the same as for monostatic radar because the reflecting direction is not normal to the direction of illumination. In an approximation, it would be arguably reasonable to assume that the reflecting points are isotropic and so will reflect the same amount of energy in all directions. The assumption may be more difficult to justify if the bistatic angle is large and the correct approach would be to re-calculate a set of bistatic RCS data for each reflecting point on each target as a function of the illumination direction and the bistatic angle.

The research investigated and implemented a method of calculating the disposition of RCS points on a target in the direction of monostatic illumination and reflection. The spacing of RCS points is made to be equivalent to the resolution of the radar's A-D conversion rate. The transmitted waveform is also defined with the same resolution. The research used 7-10 nsec resolution based upon discussion with potential customers and the capability of a small FPGA-based implementation (the relevance of FPGAs is explained later in section 4.10).

A convolution of the waveform and resolved target RCS points was used to calculate the basic returned amplitude and phase characteristics. The radar equation was then implemented for each range step so that the returned signal amplitudes and phases could be estimated for each step. This is explained further in the next section.

4.9.2.2 Radar Capability

The Radar Capability class contains all of the parameters and methods required for performing generic radar functions. Instantiation of an object from this class results in a sub-set or super-set of the class, to describe the capability of any specific radar under test. Amongst these will be the static data, the valid design parameter ranges that the radar will support. As the scenario develops selections of power, frequency, waveform type beam angles and shapes etc. will vary These are defined as 'modes' of the radar for ease of reference, one or more parameter differences distinguish one mode from another. Clearly, instantaneous-mode demands must request parameter settings that fall within the range of static parameters. Sometimes the mode change is adaptive, in response to current information extraction from previous returns; on other occasions it may be 'scripted' i.e. the scenario calls for a particular mode at a specified time in the scenario. In the former case, the radar equipment under test will initiate the change of mode, in the second the test shell loads the instructions as time progresses along the scenario time-line.

However the modes are set-up, the current values are used to compute the return I-Q power timeseries created by the interaction between the platform's radar emission and the environment. The Radar Visibility class is concerned with defining the amplitude and phase of energy returned as a result the illuminating each target. Typically, energy will be reflected some energy may be absorbed and some transmitted.

Radar equipment typically utilises a digital processor to extract information from returned data. The data are sampled at a rate defined by the processor, typically between a few μ Sec to a few nSec, this varies from one application to another and is referred to as 'time-steps' in the following text.

The 'radar equation' is used to calculate the returned power P_r ; the equation is applied sequentially at each time step. The radar equation is a well-known and well-understood tool that is quoted here for completeness, (1):

$$P_r = \frac{P_e (G^2 \lambda^2 \sigma L)}{((4\pi)^3 R^4 k T_0 B N)} \quad (1)$$

where P_e = instantaneous transmitted power (Watts); G = gain of the transmitting/receiving antenna; σ is the radar cross section of the reflector (m^2) and R is the range (distance between the transmitter and reflector (m)). L = losses; k = Boltzmann's constant (Watts/K/Hz); B = radar receiver bandwidth (Hz); T_0 = noise reference temperature (290K); N =receiver noise figure

Three factors to be taken into account when applying this equation are:

1. The target's radar reflecting points will interact with the illumination according to the aspect of the target relative to the direction of illumination.
2. The waveform typically occupies many hundreds of time steps that each affects the instantaneously transmitted power and phase that will illuminate the target.
3. The dispositions of the targets' reflecting points relative to the platform not being fixed for each illumination pulse due to relative motion of the platform and target, including the Swerling effect.

Taking the first point, the reflection may be isotropic, diffuse or specular according to the surface causing the reflection. In this research, parameters defining these issues are included in the definition of each target's surface. Given the spatially distributed reflecting points of the target, plus the aspect of the

target's axis to the reflection direction, it is necessary to calculate the effective point reflectors in the same time-step intervals that are of interest to the receiver. This issue is discussed further in section 5.7 in the context of improving target resolution for such applications as SAR image generation. The amplitude and phase change of return, in the direction of the platform, can thus be calculated.

If the timesteps in the transmitted waveform are numbered 1 – n and the resultant reflecting points on the target at each time step are labelled a – x. The first returned power element will result from waveform step '1' and the target's reflecting point 'a', giving a return power that can be designated 1a. It will be followed by 1b and 2a arriving simultaneously at the next timestep, then 1c, 2b, 3a etc. for each subsequent step. This is addressed by convolving the waveform with the target's reflectors for the current aspect angle of the target relative to the illumination. The amplitude is modified according to the selected Swerling factor. Phase is modified by the distance between the platform and target. A timeseries of incident power and reflection characteristic (amplitude and phase) is substituted for the $P_t\sigma$, hence the returned power has modified amplitude and phase characteristics.

Verification of Implementation: the radar return implementation was verified by starting with a simple configuration, for example by checking the amplitude and phase returned for instantaneous pulses (1 time-step in the waveform signal) and a point reflector (1 reflecting point on the target) at different ranges. The waveform was extended in 'simple' ways and the point target was expected to return the waveform. Conversely, reverting to the instantaneous radar pulse and a multi-RCS target, the target RCS points are expected. Gradual increase in complexity of both the transmitted waveform and target RCS complexity was used to verify more real-life combinations by inference, clearly all combinations cannot be tested.

4.9.2.3 *ESM Sensor Issues*

ESM signals are handled in a comparable way to radar by the Visibility classes. The ESM Visibility class from which ESM visibility objects are instantiated for each target, define what emitters are carried by each target. The objects define frequency ranges, power, beam information, modulation types and bound the capability of each target's emissions. Instantaneous emissions are activated by the Scenario Generator, resulting from reading data from a scenario definition file, that defines when each will be activated and with which parameters.

In this way, for example, the scenario generator can cause two targets to appear to exchange HF communications, or for a target to perform a surveillance scan using its radar. It might illuminate the platform. Jamming is a special case of such illumination. The ESM method in the target's object model causes power to be emitted with the appropriate frequency, modulation and direction.

The platform's ESM detection method, part of the object derived from the ESM Capability class that describes the capability of the platform's ESM sensors, can then apply range and bearing parameters, LoS calculations and weather conditions to derive the power received by the platform.

An important calculation, undertaken by this class is the power received at the platform by an RF emitting target. This is given by (2); note that the antenna gain of the transmitter and receiver are separated here, whereas in the 'radar equation' they are often merged because, in that case, they are often the same physical antenna. In this case, they are clearly not the same physical antenna.

$$P_r = \frac{P_e G_t G_r \lambda^2}{(4\pi R)^2} \quad (2)$$

where parameters are as previously defined

4.9.2.4 Other Sensors

This research defines a system that will support multiple sensors although the work has not included implementation of other types. Simplified but unverified LIDAR and EO/IR transfer equations have been reviewed as a pointer for the direction of future work. They also indicate the likely relative complexity in relation to available processing power required for the current implementation.

LIDAR: Simplified Light Detection and Ranging (LIDAR) is a ‘radar’ system but it uses laser light rather than RF. The received power P_r is defined by the equation (3) that assumes a Lambertian diffusely reflecting target surface in the near field, otherwise the R4 law applies [90] page 71. This requires further investigation with a subject matter expert before implementation,

$$P_r = \frac{\pi P_e \Sigma^2 D^2}{(4R)^2} \quad (3)$$

Where Σ is the optical reflection coefficient of the target; D = diameter of collecting lens; other parameters as defined previously.

Electro-Optic (EO) and Infrared (IR) sensors are possibly the easiest to visualise because of our familiarity with camera and optical behaviours. Infra-Red (IR) is an extension of this at a slightly lower wavelength. Visible light occupies the region 0.4 to 0.7 μm whereas IR occupies the band 0.7 to 1000 μm , although most applications operate to around 15 μm . Radiation includes re-radiated and emitted components, the latter being a thermal radiation. EO/IR radiation leaving a surface behaves in a similar way to other types of radiation and generally will be emitted in all directions, thus the inverse square law for power dispersion is applicable. This law is depicted graphically in Principles of Naval Weapon Systems chapter 7 Fig 7-14 [91], a book that provides a useful low-level introduction to many of the sensors of interest to this research.

Lenses form a key part of EO/IR systems and so optical physics offers much of the mathematics needed to define the images that will be created from a

given scene. 'Light', meaning radiation at whatever wavelength being considered, is generally focused onto a sensor array that can be fixed or scanning. The light energy is converted into electrical energy to allow electronic processing. The scanning systems include line-scan of various types, often with many lines being produced in parallel rather than the single line that television systems use.

The received energy is expressed by the following simplified equation (4) expressed in 'Principles of Naval Weapon Systems' by Craig Payne. [91] Page 145 equations 8-24:

$$P_e = \frac{F_\varepsilon k(T_0^4 - T_\varepsilon^4) A_{tgt} A_\varepsilon}{4\pi R^2} \quad (4)$$

where F =bandwidth (Hz); ε =emissivity (Watts/m²); T_ε =absolute temperature of the target (K); A_{tgt} =surface area of the target (m²); A_ε =area of the detector (m²) and other parameters are as defined previously).

4.9.3 A Dynamic Situation

It is now appropriate to consider a dynamic situation, to explain the interaction between the various parts (the models) within the SE.

The scenario generator keeps track of time and moves through its scenario script applying any changes to the speeds, accelerations and operational modes of the platform and targets. Meanwhile the targets and platform calculate their location according to their motion parameters; the targets also report their relative positions to the platform model.

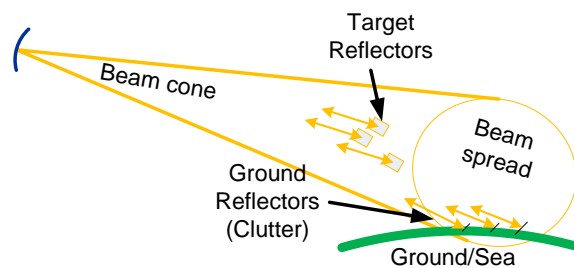

Figure 23 – Radar Reflections within a Scenario

The platform is directed by the system under test or the scenario generator to adopt a particular radar mode (frequency, power, PRF, waveform pattern) and to direct its beam (with a defined beam shape) in a selected direction. A platform Radar Capability method interrogates the Visibility parameters of each target to identify its RCS sizes and spacings. Once converted to the set for the aspect of target relative to the platform, these are convolved with the transmitted waveform to calculate the contribution to returned energy and phase from each target (see Figure 23). This is modified by beamshape-gain plus any relative radial motion. Bearing affects phased array gain and power is modified by range attenuation (R^4 see (1)) if compensating automatic gain control (AGC) is not activated. This is repeated for each target so that there are as many radar-return data sets as there are targets. A platform Radar Object method performs a similar function with the Location Object to support calculation of the multiple clutter returns – also shown in Figure 23. All returns are calculated on a time basis, i.e. range steps, following the transmission time with each step of the transmitted waveform being reflected (with possible phase and amplitude changes) and added to any other reflected energy in the same time period. The return to each emitted radar pulse is the time-sorted sum of all returns suitably modified by any line-of-sight and weather effects that may be introduced.

It may happen that another pulse is transmitted before all of the range returns have been received. This produces ambiguous range data. The beamshape may be such that side-lobe returns from a large reflector have significant energy and can be confused with a smaller target in the main lobe. This produces the bearing alias familiar to radar operators. If there is relative range velocity between the platform and target there will be appropriate phase shift adjustment so that the pulse-pulse Doppler Effect is replicated as previously described.

The verification of the proposed design in these areas is described in Appendices I.1 (amplitude and range), I.5 (pre-pulse timing), I.8 and I.9 (range and bearing gating), I.12 (beamshape issues) and I.13 (antenna pointing angle issues).

Some notable exceptions extend the complexity of the previous description.

Time-Range error sources 1: SAR imagery applications require very accurate pulse-pulse correlation of data so that the image can be correctly built. Discrepancies cause blurring of the images. The time of transmission must be known accurately – so that the range can be defined accurately. If the relative range is updated less frequently than the calculations are made, the resultant jerky motion will cause unacceptable phase discontinuities in the returned signal. Section 4.9.1 describes how platform-target distance is measured by phase angle on a pulse-pulse basis to achieve the necessary resolution.

Time-Range error sources 2: Phase coherence of the transmitted pulse and the returns must be high so that processing algorithms are not subjected to non-coherent data. When the pulse is initiated by the real equipment, calculation inaccuracies will be introduced in the UUT if the synthetic return is at an inappropriate time. Appendix I.5 describes how the pre-pulse timing verification was undertaken.

Pulse Compression Error source: The waveform must be accurately replicated so that pulse compression (i.e. correlation between the waveform and returned signal amplitudes and phases) in the UUT will operate without undue degradation. Appendix I.11 describes the verification of the transmitted waveform design issues.

Waveform Consistency: Some radar modes of operation require a comparatively long period of illumination during which many pulses are issued, and during which other transmission parameters may change. Waveforms are one such parameter. The coherence of returns with transmitted waveforms must be maintained during the burst of target illumination (a 'burst' is more-correctly called an EXI (EXecution Interval). Short-range operations, such as for combat operations, are an example where waveforms change on a pulse-pulse basis in the EXI, this allows range ambiguities to be removed more easily. The proposed system copes with this by supporting coherent waveform generation during an EXI period.

RF Generation: ESM stimulation for test purposes requires RF signals to be applied to an ESM receiving system under test, or equivalent signals to be injected into later parts of the processing chain of the UUT. The Scenario Generator causes each target to emit RF for any of its RF transmitting equipment. The modulation power, frequency and duration of transmissions are controlled by the Scenario Generator as described previously. Many emitters may be active at any time on one or more targets. The ESM equipment is therefore presented with a range of signals, from differing directions, as depicted in Figure 24. Some of the signals will be directional and others omni-directional. The sources may be friendly (green), hostile (red) or neutral (blue). The ESM equipment is required to identify the source of signals and its likely intent. Weather conditions cause ducting and fading to influence the power received versus range between targets and the platforms. There may be many hundreds of signals present at one time.

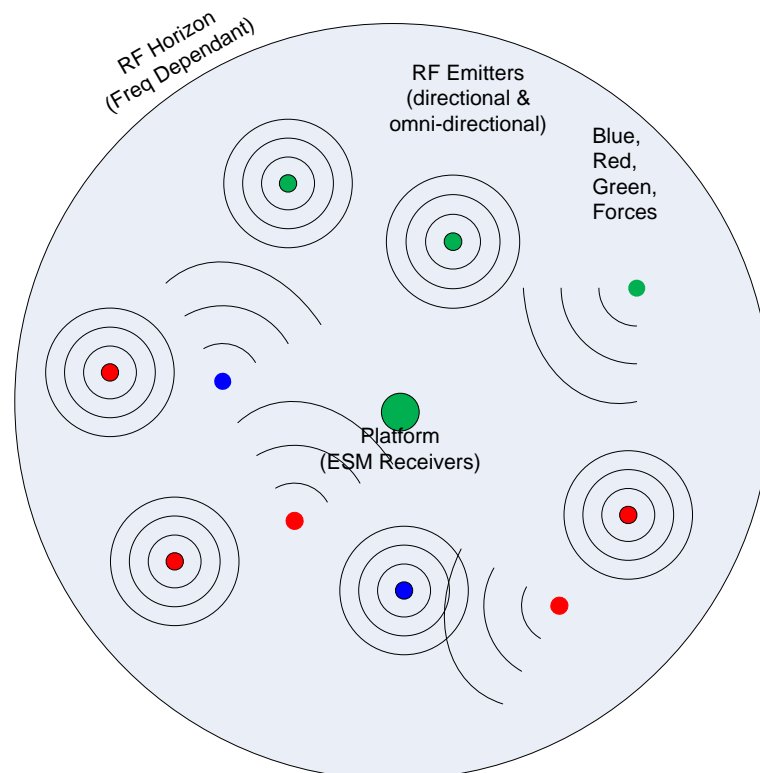

Figure 24 - ESM Environment

4.9.4 Sensor Functionality Summary

The capability and visibility classes describe each sensor type, here radar and ESM are considered. The capability classes, shown in Figure 21, are associated with the platform and describe the platform's sensors capabilities. These parameters are identified in section 4.7 and include:

- **Static parameters for the platform's radar**, list numbers 1a i (selectable power, frequency, PRF, PW, waveform); 1a ii (selectable beam gains, shape, pointing direction); 1a iii (antenna location – relative to centre of platform)
- **Dynamic parameters for the platform's radar**, those that change as a scenario develops, list number 6b I (current frequency; PRF; PW; power; beam shape; beam pointing angle)

The responses to these transmission parameters are dependant upon:

1. **Target characteristics** that are also in the list, numbers 2b (size (length, height, width, centre of mass); 2c i (RCS – 3-D spatially distributed radar reflectors in aspects of interest as a minimum); 2c ii (amplitude, phase response and physical size of each RCS point).
2. **Other** Radar responses are also dependant upon weather and terrain information, particularly obscuration. Weather tends to attenuate the return and obscuration removes it altogether. Multi-path effects are also important and this is dealt with in section 5.6, here we are concerned with basic radar returns.

4.9.5 Configuration Considerations

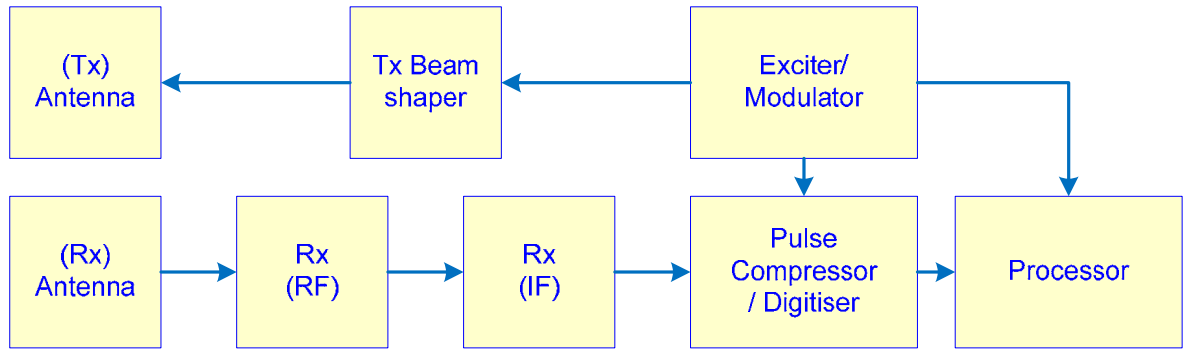

Figure 25 - Radar Block Diagram

Mention has been made of UUTs and signal injection at different points in the processing chains, this section explains the relevance of these issues.

Figure 25 shows a typical block diagram of a radar transmitter and receiver. The exciter/modulator is used for both the receiver and the transmitter; it modulates the outgoing radar pulse. It is also used to compress the received signal to improve range resolution. This allows a higher energy (wider) pulse to be transmitted whilst retaining good range resolution. The transmitter part of the diagram shows the power generation and beam shaping elements. The receiver part includes RF and IF amplifiers prior to pulse compression, digitisation and processing. Typically, the processor is also used to control the modes of transmission, the number of pulses in an EXI and the antenna look-angles.

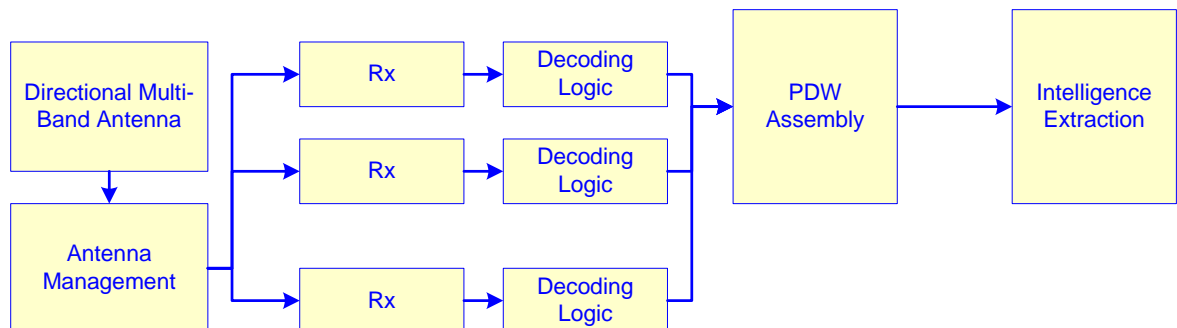

Figure 26 - An ESM Processor Block Diagram

An ESM processor is shown in Figure 26. It comprises a multi-directional antenna capable of wide frequency coverage (or several antennas controlled by a management system). The receivers are arranged to scan their bands sufficiently rapidly to cover the required bands in an appropriate time whilst dwelling long enough to allow detection of weaker signals. The decoding logic identifies the modulation type, pulse widths (where appropriate) as well as power levels and reports these for each signal to a pulse descriptor word (PDW) generator for further processing, to assess threat levels for example.

Data fusion, that utilises these two signal types, might be configured as shown in Figure 27. It can be seen from the diagram that two extra blocks have been added to the right of the composite diagram. One extracts (fuses) information from the radar and ESM data sets and the second uses this to perform an action such as deploying an appropriate weapon system or other countermeasure to a threat. Other possible uses of data fusion are to provide better situational awareness to other military assets involved in an action, or simply to gather improved intelligence for future use.

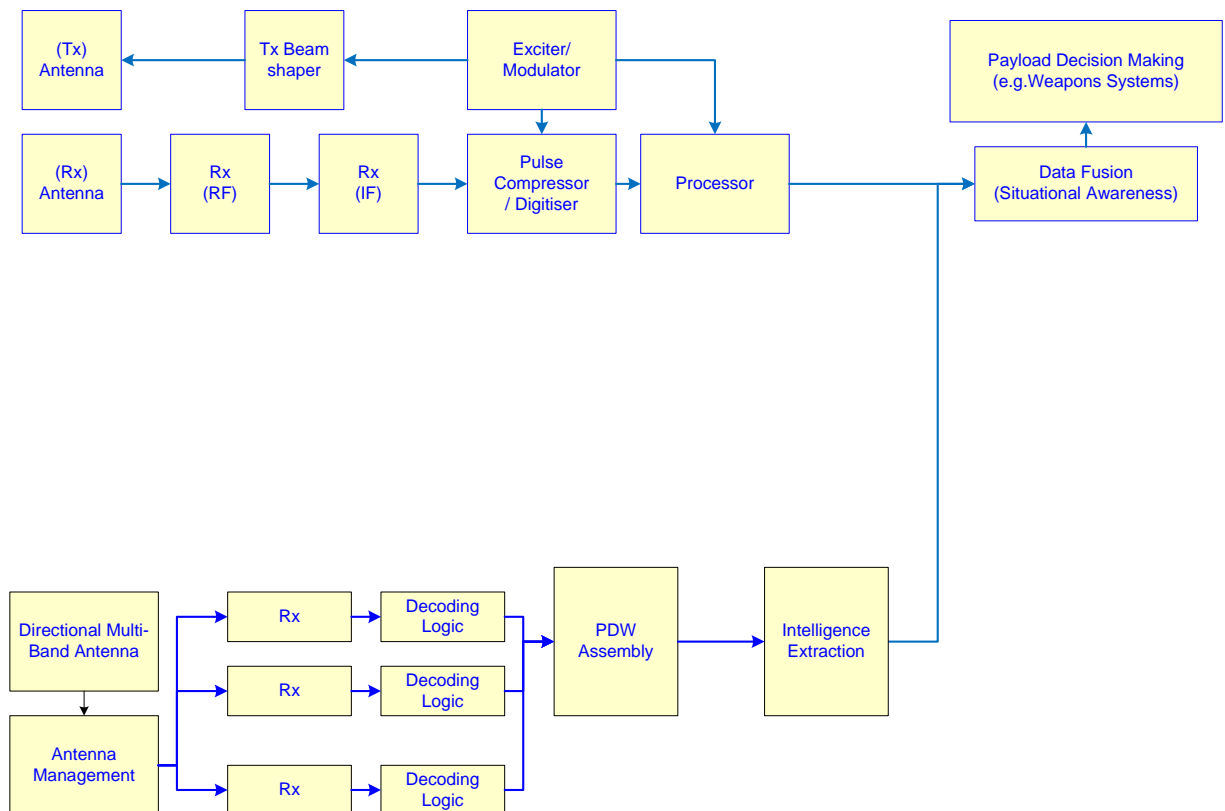

Figure 27 - Possible Radar and ESM Data Fusion

The purpose of this research is to provide suitable stimuli to test such data fusion systems and this is shown in Figure 28. The diagram shows the previously described radar and ESM processors plus additional blocks. It should be noted that the logical flow of the radar and ESM processing is from left to right, antenna to processor. The stimulation process has a logical flow that is from right to left.

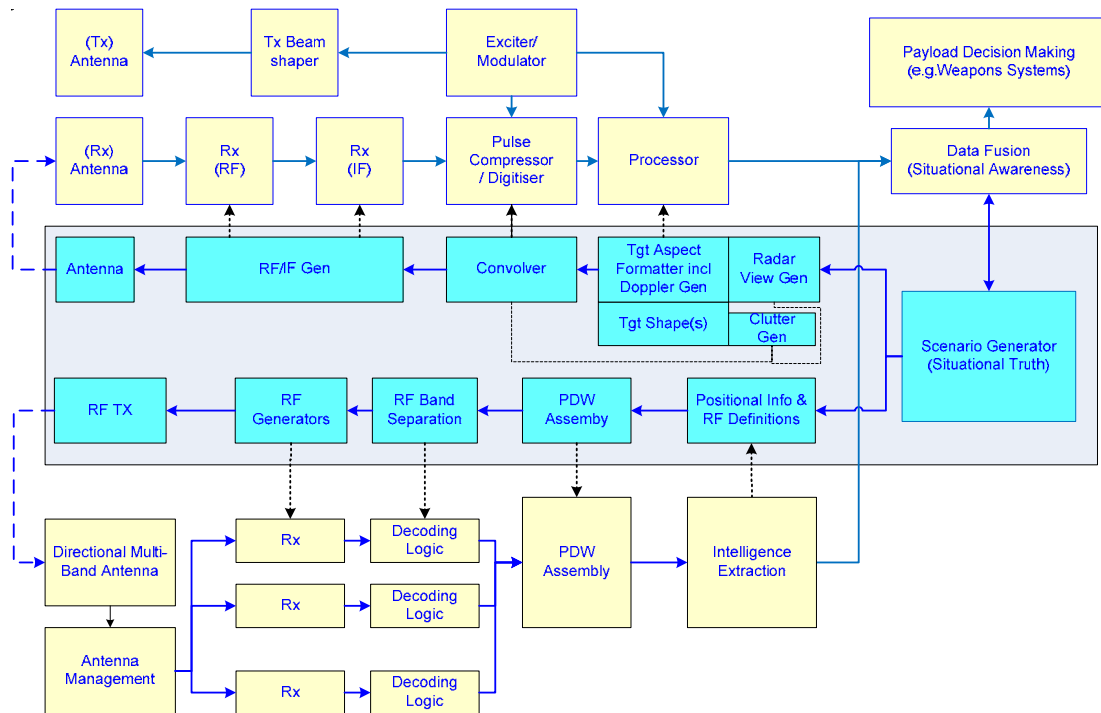

Figure 28 - Synthetic Stimulation of a Data Fusion System

The Scenario Generator represents the ‘truth’ regarding the deployment of targets and their activities that the ‘Situational Awareness’ processing block of the data fusion configuration seeks to derive from its input signals.

The central blocks in the diagram, with the Scenario generator on the right, show the radar stimulation components at the top and the ESM stimulation components at the bottom, both driven by the same scenario and scenario generator. If other sensor types were being considered, they would be handled in an equivalent way. The dotted lines show the signal paths from the stimulation to the components of the radar and ESM equipment being tested. This is important when not all parts of the equipment are available for integrated testing and their outputs are to be replicated for test

purposes. For example, raw detection data are generally input to a processor in the radar processing chain so that, for example, tracks can be identified. The diagram shows that such data are generated from the Scenario Generator and can be injected to replace the real signals. Moving along the stimulation chain, the same data can be presented to a pulse compression unit or into IF and RF units.

Ultimately, the data may be transmitted from a simple antenna directly to the radar's main antenna to provide stimulation of a complete radar equipment. An alternative view that simplifies this concept, showing typical injection points in the radar equipment is shown in Figure 29.

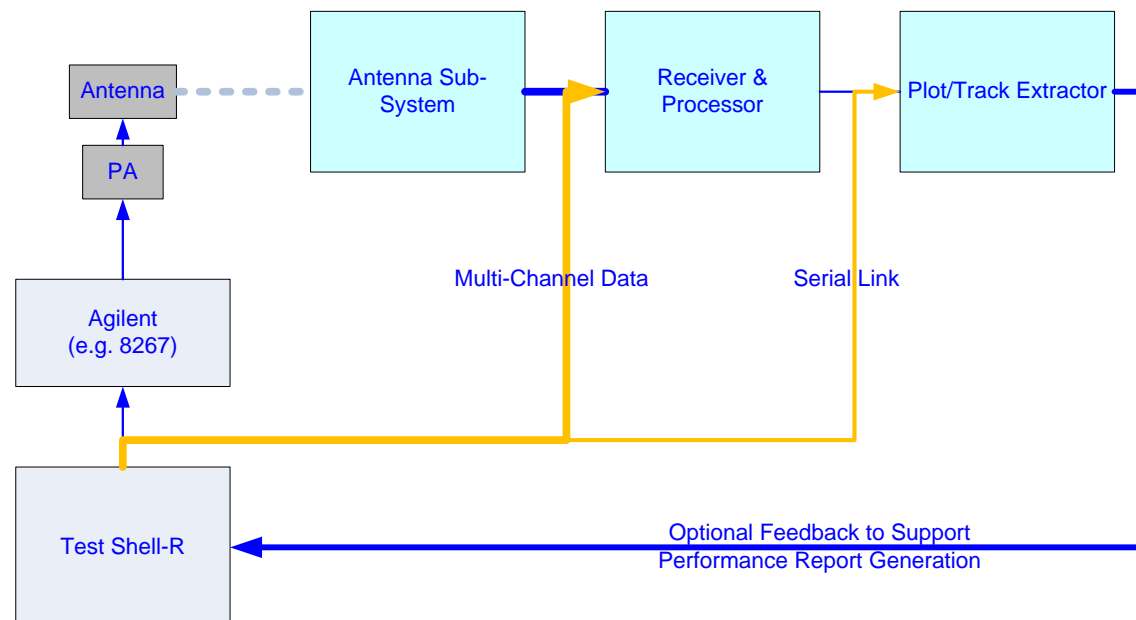

Figure 29 - Deployment of a Radar Stimulator

The Test Shell-R block is a radar test shell that evolved from this research. The -E (ESM) variant is not shown in this radar application.

The figure shows the base-band generation of radar returns (bottom left) driving a plot-extractor (part of UUT) and an RF generator (part of test equipment). The RF generator, with frequency, power and modulation controlled by the base-band generator can be used to inject signals into a Processor or Receiver (depending upon the functionality of the UUT). A Power Amplifier and horn antenna added to the RF Generator's output would allow radiated injection of controlled signals into a UUT that is a full radar receiving equipment. For such RF injection, the radar's antenna

would need to be stationary and pointing towards the horn, or pseudo data only being injected from a narrow angle. The injection may replace or supplement real signals to replace or augment the reality view. Augmentation allows operator training in an operational environment, for example a simulated attack emerging from a 'normal' situation observed by the operators.

Similarly, the various functionality of ESM equipment can be stimulated by injecting appropriate data into the functional elements of the ESM equipment as shown in Figure 28. Scenario Generator data can be used to inject bearing and RF analysis into the Intelligence Extraction function responsible for combining the types of emitters to estimate what might be carrying them. For example, some combinations might indicate the target is more likely to be a commercial aircraft than a military helicopter. The Pulse Descriptor Words (PDWs) can be constructed and used on their own to inject into a suitable point, or used to generate actual RF signals. Suitable low-powered transmitters can be used to inject the RF directly to the antennas of the ESM equipment.

There are practical constraints and considerations to be taken into account the following are two examples:

- 1 Until standardisation of interfacing is achieved for military equipment, the physical links will be specific to each UUT (e.g. wire, fibre-optic plus a range of protocols)
- 2 The number of RF generators to provide ESM RF transmissions directly to ESM antenna can become large and unwieldy.

There is a need for cost-effectiveness to be analysed to decide the point at which the increase in value is not worth the increase in cost to achieve it. Following sections will address some issues and the techniques that can be used to improve effectiveness and minimise the cost.

4.10 Processing Issues

This section explores the implications of the foregoing upon the processing demands of the stimulation equipment for it to drive the Unit-Under-Test (UUT) successfully. There are a number of issues related to the lifecycle stage and the application being tested. A simple situation, with minimal demands, will be considered first.

If the platform and targets were allowed to move according to pre-planned routes and with pre-defined parameters, it would be possible to pre-calculate and store the data required to stimulate the UUT. This would reduce the processing load to a level that would allow a PC to produce the data. The trade-off is that the amount of data storage would increase as a function of the data rate of the stimulation, the number of targets and the time for which a scenario is to be run. Disc storage is normally used for large amounts of data. Recovering the data from disc to memory is an overhead and, with a data transfer rate of 40-60 MBytes/sec, is at the upper boundary of a PC's input-output (I/O) capability.

This sets the capability of the resolution and sampling rate of data to stimulate the equipment being tested. It translates to radar data comprising I-Q pairs with 16-bit resolution, with maximum sampling of around 10-15 Msamples/sec. (4-Bytes x 15 Msamples/sec = 60 MBytes/sec) A scenario of 10 minutes would require storage of 24-36 GBytes of data; this storage requirement is modest by PC disc standards.

The assumptions in the simple case were that there were no other interactions with the UUT other than data transfer. When a radar pulse is transmitted, it is necessary to close down the receiving circuits, prepare output stages and synchronise the generation of the waveform. Other activities may also be required and these are distributed amongst the various radar sub-units. In a practical system, as well as control signals to the UUT it is also desirable to monitor responses so that a time-correlated log of inputs and outputs can be made available – a test shell function.

A pre-pulse signal is a common way to indicate to the sub-units that a transmission is about to take place. The actual transmission starts at a constant and known time after the pre-pulse as shown in Figure 30.

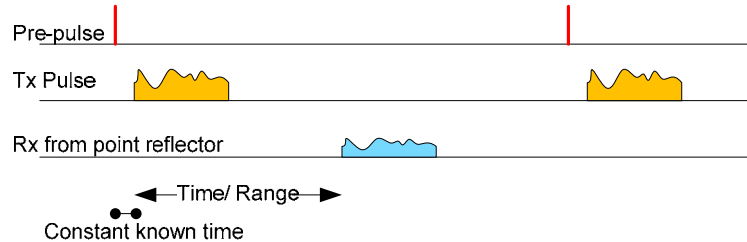

Figure 30 - Radar Pre-Pulse

The radar returns, measured from the pre-pulse time, represent the range of a target, plus a constant offset. If the UUT includes sub-units that require this pre-pulse information, it must be provided by the stimulation equipment or by the UUT. If provided by the UUT, the stimulation equipment must synchronise returns as just described, in such a way that there is no jitter on the timing of the returns. The (10-15 MHz) clock signal driving the I-Q data to the UUT must be locked in phase to the pre-pulse signal. The easiest way for this to occur is to use a suitable clock signal from UUT, the signal from which the pre-pulse was derived would be ideal. It is electronically more complex for the stimulation equipment to provide a clock signal with this feature.

These requirements add further demand on a PC and its capability rapidly becomes the limiting factor in the range of testing that can be performed. Lifecycle stages that do not require real-time interaction with hardware and can be met by slower processing; however, a fundamental issue is being able to run the test system to meet real-time testing demands. This places greater demands upon processing speed, low latency in transactions and similar real-time issues and is dealt with in section 4.10.2.

4.10.1 Exception Cases

There are two classes of exception. The first arises if stimulation of the UUT is to occur before the pulse compression circuits. Data resolution of 10-15 Msamples/sec will be inadequate because pulse widths down to 1 μ Sec

would be only coarsely correlated with the returned waveforms (around 10 samples per return). A clock rate of 100 MHz or more is appropriate. One UUT of interest has a correlation clock rate of 150 MHz, and it is good practice for test equipment to be 'better' than the UUT. Processing data at these speeds is not possible with a PC on its own. This clock speed allows the I-Q data rates to be over 400 MBytes/sec for 16-bit resolution data and this exceeds the I/O capability of a test-shell architecture comprising a single PC with standard peripherals. Potentially, this is a problem, but the real situation is worse if a flexible and generic test shell is required.

The simple examples assumed that the platform and targets could all be constrained to move according to pre-planned routes with their modes of operation fixed. This precludes testing a dynamically adaptable UUT, for example one that could change its dwell-time and waveforms according to the type of target identified. Such performance requires that there is increased interaction between the UUT and the stimulator. If a particular target type is identified by the UUT, it will cause the beam pointing position and waveforms to adapt to a sequence other than the ones they may have been following. The types of radar and ESM equipment with such capabilities typically use internal data buses for this type of control. The military data bus type Mil Std 1553 is one such example [92], others include Ethernet of various data capacities (10/100 Gbits/sec for example) [93]. This places a requirement on the stimulation equipment to be able to support these busses physically and to have suitable software to respond appropriately to such commands. This increases the processing demand.

If this requirement is added to one for an I/O data rate that is near maximum for a PC, there is severe risk that the PC will not be able to maintain real-time operation. In borderline cases, it could be that it moves to the wrong side of the real-time speed capability under some circumstances (particular types of parameter change demands, for example). This would be very likely to cause the UUT to exhibit 'false problems' i.e. the output of the UUT may be unexpected, but because of the 'faulty' stimulation equipment not because of an inherent UUT fault.

To add to the problems, PCs occasionally suspend user-defined operations because of an operating system request to validate its own internal configuration. This effect can be minimised by suitable choice of operating system but it is always present to some degree. It can manifest itself as a 'spurious' failure that cannot be predictably replicated and is independent of user commands.

The only way to resolve the issue of processing power being too low is to increase the processing power by incorporating faster machines.

4.10.2 Options for Higher Speed

Assuming that the fastest available PC with a suitable operating system is already being used, there are two main options for increasing the processing capability.

- 1** A PC 'farm' – several PCs that are linked to share the processing load.
- 2** Add one or more co-processors – e.g. GPUs or FPGAs

The first option seems attractive and is appropriate if the processing can be suitably devolved into self-contained functions that do not require significant data sharing. If, for example, a system were to be conceived that utilised 4-PCs in a way that the I-Q output data was multiplexed between them on a range-step basis, all PCs need access to the waveform, clutter and target data. The processed results need to be re-synchronised and merged into a single data stream with accurately phased clocks for delivery to the UUT. The amount of inter-computer transfer would result in latency around four times that to recover data from disc and deliver them to a single processor. This would detract from the objective of reducing overall processing time and result in a less-than-expected performance improvement. The re-multiplexing would add further hardware that would be bespoke. The issues of inter-computer fast communication could be addressed by a special backplane switching arrangement such as a Mercury

Raceway bus used for VME based architectures²³, other options are more attractive because they do not require data synchronisation between the processors and post-processing multiplexing.

4.10.2.1 GPU vs. FPGA

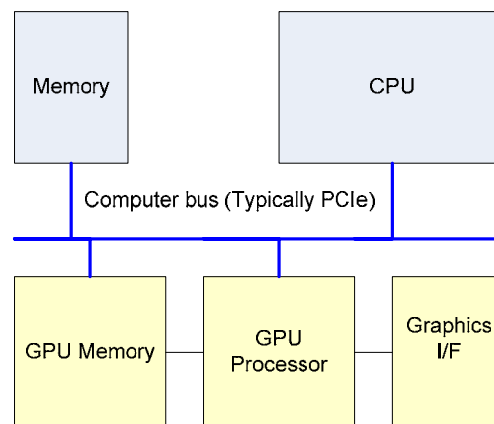

Figure 31 - GPU Architecture

Graphics Processing Units (GPUs) are sophisticated graphics boards for PCs; computer games are a main market for these devices. GPUs (as their name conveys) are designed to accelerate graphics processing by rendering high quality 3-D images onto a computer screen. As an example of these devices, nVidia are one manufacturer with a proprietary Compute Unified Device Architecture CUDA²⁴. The programming language 'C is available for CUDA', other language wrappers and some other program native support e.g. Mathematica (CudaLink²⁵) and MATLAB (Parallel Computing Toolbox²⁶), for programs compiled to run on GPUs, making them comparatively simple to use. Coupled with a cost of around £200 or so (2012 prices), that comes from high-volume production, these 'Gaming Cards' offer limited but high speed processing. nVidia GTX 680 offers a memory bandwidth of around 100 GBytes/sec with its processor that has a processing speed of over 3,000 x 10⁹ Floating-point Operations per Second (3,000 GFLOPS). These boards

²³ VME systems are expensive, power hungry and are being overtaken in performance by PCs. The switching buses allow multiple board configurations to be re-configured dynamically into several systems that operate in parallel, then switched back to allow different access to memory boards, for example.

²⁴ http://www.nvidia.co.uk/object/cuda_home_new_uk.html

²⁵ <http://reference.wolfram.com/mathematica/CUDALink/guide/CUDALink.html>

²⁶ <http://www.mathworks.co.uk/products/parallel-computing/>

are particularly good at such operations as colour rendering, shading and adding texture to surfaces. In general, these are matrix operations. Graphics boards' architecture and connection to a PC are shown in Figure 31. In use, the host processor transfers the data to be processed via a computer highway, typically PCIe [94], to a memory associated with the GPU. The processor then instructs the GPU to apply the required processing and the results are returned to the GPU's memory for collection or transferred to a graphics connector, typically HDMI [95] or DVI [96].

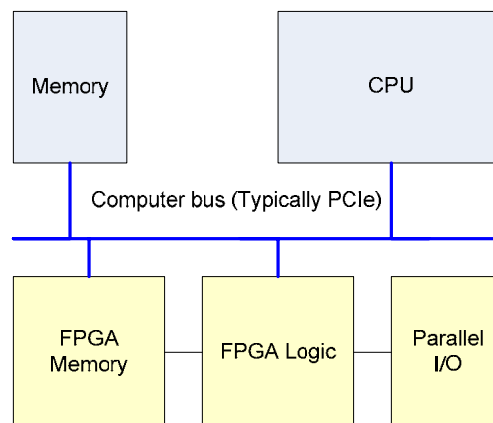

Figure 32 - FPGA Architecture

FPGA boards are sometimes called ‘warp-speed’ boards – especially by those familiar with GPUs, because of their ability to deliver very high calculation speeds and low latency. FPGAs have an internal architecture described in terms of logic gates, flip-flops, and multipliers. Although there is some software support for programming them, including MATLAB compilation, the design tools derive more from hardware than software design techniques. It is possible to use pre-built blocks of functionality to perform some functions, such as FFTs. The MATLAB support takes this form. However, most designs are specialist activities requiring a good understanding of hardware design techniques including timing, delays, latency and pipeline propagation. Once done, the processing speeds are usually considerable faster than can be achieved in any other way. Their architecture and typical connection to a PC are shown in Figure 32.

In addition to the backplane (PCIe bus) transfers, they can accept and deliver data via parallel interfaces directly to the FPGA device(s) at rates well

over 100 MWords/sec, where a word is the application-relevant width of the I/O interfaces (1, 64, 128 bits etc.). The parallel I/O capability can be used to share memory between boards as well as for I/O with external devices.

A GPU can be considered a specialised and pre-programmed variant of an FPGA board. The processing capability of an FPGA is general purpose but much faster than a GPU. An FPGA has parallel data or sometimes fibre-optic I/O capability. However, at a systems design level FPGAs and GPUs are similar as can be seen by comparing Figure 32 with Figure 31.

If the FPGA architecture is applied to the previous problem of triggering the start of I-Q data output after an accurately known delay from a radar's pre-pulse, it adapts very well. The pre-pulse would be applied directly to the FPGA board and its presence would be acknowledged within a few nSec as an absolute maximum. The action would start a counter, pre-loaded with a value to represent the required delay, which uses a high-speed (nSec) accurate clock signal to decrement the counter to zero. When the count value expires, the data in memory would be output via the parallel I/O or fibre-optic ports directly to the UUT. The latency of this configuration is much less (i.e. greatly improved) compared to what can be achieved by using the PC to initiate the transfers. It will be noted that, if a GPU were to be used, the I-Q data would need to be transferred from the GPU's memory to the CPU's memory because a GPU does not have a suitable output port for direct connection to the UUT.

4.1.1 Design of the Test Shell

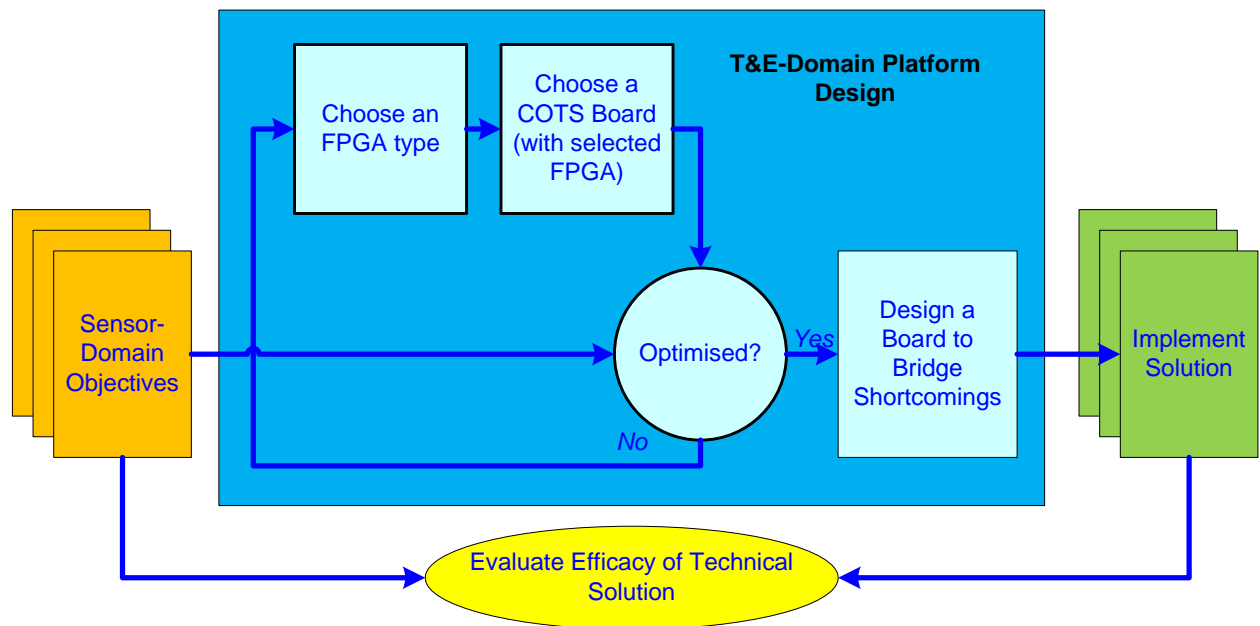

Figure 33 – Test Shell Design Process

The left-hand side of Figure 33 (Sensor Domain Objectives) depicts the problem definition. The basic parameters for the radar and ESM example applications are introduced in sections 4.4 and 4.5 respectively and these are formed into an example sensor-domain structure in sections 4.12 and 4.12.3. The operations needed to define the architecture of a hardware test-shell solution are shown in the centre of the diagram. The resulting hardware configuration will be used to implement the algorithms needed to meet the sensor domain objectives, as shown on the right-hand side. Verification of the resulting test shell can then be performed to verify that the algorithms are correctly implemented and to validate the test shell. Section 4.10.2.1 explains that a PC and FPGA solution is selected as a basic configuration.

There are many FPGA types; Table 20 presents a summary of the features of the Virtex 5 to 7 families of devices produced by Xilinx²⁷ (V5 – V7). It can be seen from the table that the choice is complex with many variables, as well

²⁷ Xilinx, Inc., 2100 Logic Drive, San Jose, CA 95124-3400 (408) 559-7778

as basic clocking speeds and, for some applications, power consumption parameters to be considered.

It is desirable to find a COTS board that includes the required FPGA; otherwise, a special board must be designed and this moves away from the objective of using COTS products. The circuit board that carries the FPGA will have other system features. PCI Express interfaces for connecting to a PC. Ethernet, analogue convertors, additional memory, and disc interfaces as well as Ethernet and high-speed fibre channel links are typical of the options available. However, it is unusual to find a perfect fit between system requirements and the features available with COTS products.

| Internal Processing Element | V5 | V6 | V7 |
|--|------------|-------------|-------------|
| Processing blocks – ‘and’ ‘or’ ‘xor’ etc | 5 – 50 k | 74 -600 k | 0.4 – 2 M |
| Memory – random access memory inside the integrated circuit | 1 – 18 MB | 5 – 40 MB | 19 -68 MB |
| DSP blocks –small ‘slices’ including adders multipliers etc. | 24 – 2k | 0.2 – 2 k | 1 – 3.5 k |
| Distributed memory – small memory used for local fast access | 0.2 – 3 MB | 1 – 8 MB | 0.8 – 50 MB |
| Clock domains – areas of the circuit that operate with a common clock | 1 - 6 | 6 - 18 | 6 - 24 |
| PC processors –standard PC | 0 - 2 | - | - |
| I/O transceivers – convert between serial links and parallel operation on the circuit | 0 - 24 | 4 - 48 | 16 - 96 |
| Parallel I/O – pins that can be used for data transfers | 200 - 1000 | 360 – 1,200 | 600 – 1,200 |

Table 20 – FPGA Families vs. features

This selection process is iterative and seldom is there an ideal solution. There are likely to be requirement features not supported by the FPGA/board solutions available from the COTS range. This issue can be resolved by designing an additional hardware module and adding it to the FPGA or host processor according to its function. This activity is shown to the right of the diagram, inside the T&E Domain Processor Design block.

Once a physical T&E processor exists, the figure shows that the next stage is implementation of the solution. This requires a software/firmware mix of

disciplines to provide a massively parallel processing operation to achieve the required functions with the necessary speed and response times. These issues are discussed in section 4.11.4.

4.11.1 Design Considerations

The architectural design must take into account the movement of data internally within the T&E processor and the storage and recovery of intermediate data. These issues require suitable selection of appropriate storage media and their locations relative to the processing blocks in the distributed architecture storage issues. Intermediate data may need to be stored during processing for later recovery. System parameters may also need to be stored. The fastest storage and recovery will be achieved by use of distributed memory, but the capacity is very low. On-chip random access memory (RAM) offers more storage capacity with slightly longer access time but still the capacity is low, 1 to 68 MBytes across the whole family range. Off-chip memory, on the FPGA's circuit board, can extend this to hundreds of MBytes but with slower access. The memory is likely to comprise dynamic RAM (that loses data on power-down) and erasable programmable read-only memory (EPROM) for permanent storage. Interfaces to discs or redundant arrays of inexpensive discs (RAIDs) from the circuit board are slower but offer upwards of GBytes of capacity. Finally, system disc storage connected to the processor that is hosting the FPGA board can be used. This saves the cost of direct disc access via the FPGA board but increases the access time even further. The range of access speeds varies from nsec to 10's of msec between the various storage types. As the access time reduces, it can also become more variable due to other activities requiring access to shared internal system data buses to which the devices may be connected.

4.11.2 Transfer rates and latency

The design considerations frequently involve issues with rate of delivery and latency of data. These issues apply within the design as well as to transfers between the UUT and the T&E processor. Rate of delivery is the rate of data transfer, once it has started. Latency is the delay between a triggering event

and the transfer being initiated. To take an example of target positioning, if data transfer is incorrect the error in the radar-detected position of a target would be proportional to its range. If there is latency, all target positions will be displaced in range by a fixed amount. If these issues are seriously bad they could extend to bearing errors.

For example: suppose that there are point targets at ranges 6 km and 15 km. The return times should be 40 μ sec and 100 μ sec respectively.

If the test shell suffers a 10% slow data transfer rate, a radar return time-series would present the target returns at 44 μ sec and 110 μ sec respectively, or 6.6 km and 16.5 km. The range errors are 0.6 km and 1.5 km respectively – proportional to range.

If there is a latency of 1 μ sec in the test shell, a radar return time-series would present the target returns at 41 μ sec and 101 μ sec respectively, or 6.15 km and 15.15 km – a fixed error of 150 metres.

The measurement period for latency, in many applications of the sort addressed by this research, is nano-seconds. Data rates of serial data are measured in giga-bits per second (Gbs). This is equivalent to a demand for range accuracy of 0.3 m. In most applications encountered so far, a fixed range error of this size is acceptable, range jitter, however, is not acceptable. This is particularly true for SAR applications where repeatability over long illumination periods is required. Range dependent errors are also not acceptable. Measurements have been made by the author, and repeated by subject matter experts, to establish that these criteria are met.

Variation in the latency can occur if access to storage or processing assets is via a shared data bus. If there is other activity on the bus, access delay will vary according to the size of other transfers and their start time in relation to the new demand being asserted. It will be clear that a variable latency is likely to cause errors that can be very difficult to diagnose. In the case above, it would cause all targets' positions to jitter on a pulse-by-pulse basis.

4.11.3 Monitoring facilities

It will be appreciated that the test-shell must be able to receive signals as well as apply them to the UUT. In the case of a radar application, an example of a latency-critical input signal is the pre-pulse that defines the transmission time of a radar pulse. However, in some applications, where the current UUT radar design does not yet include an exciter, the pre-pulse can be delivered by the test shell. As well as such time critical signals upon which the performance of the UUT depends, another group of data is associated with output from the UUT. These data include information such as the positions of detected targets. This information can be used by the T&E processor to help assess performance parameters of the UUT.

4.11.4 Implementation Issues

Software is required for the PC that hosts the FPGA board(s) and firmware is required for the FPGA configuration(s).

It will be appreciated that the software/firmware solution will require the following issues to remain at the forefront of the implementation considerations, so that the processor's hardware design is not compromised:

3. Can the processor communicate with the system under test (UUT) in an appropriate timeframe?
4. Can the processor distribute information around its internal architecture in such a way as to meet the required timings?
5. Given a massively parallel processing operation, can the partial results be assembled into the appropriate times-slots and delivered to the UUT via the selected transfer mechanism in a timely manner?
6. Given the actual algorithms required (these can often be subject to change from those originally proposed), will the processing architecture support them for timely delivery, and how much spare capacity is available for changes?

7. The following chapter addresses these issues for the radar and ESM domains that were selected for inclusion into this research to demonstrate the feasibility of this approach.

Ideally, the T&E processor design will also support many sensor test-shell applications. There will, necessarily, be variations of software and firmware to accommodate the different objectives. It is the intention of this research that any single sensor T&E processor design will be a sub-set of the total design. In this way, the benefits of a generic test shell, compared to a bespoke system, can be realised. This modular approach will support data fusion applications by adding appropriate FPGA family members and their (COTS) support circuit boards according to the mix of sensor types. The implementation will include common elements for all sensors, the platform and target positioning modules being an example.

4.11.5 Formal Verification of the Design

The test shell design will be effective if it satisfactorily meets the needs of the currently considered sensor application, with sufficient flexibility to adapt to foreseen future needs. It is clearly necessary to design tests, assess the results and interpret any unexpected outcomes for the T&E processor design, plus its sensor domain software/firmware, here referred to in this thesis as a T&E test shell, or just test shell.

Two basic types of formal testing are undertaken to verify requirements. The first of these is to apply a set of defined tests to the test shell in isolation, i.e. not connected to a sensor equipment to be tested. The output responses of the test shell to various stimuli can be applied to verify correct operation of the test shell. Measurement of synthetic target's range and bearing by monitoring I-Q outputs is one such example. The target's time position in the output stream is predictable and should only be present at the appropriate antenna bearing. Appendix H describes such tests and a test procedure for them exists. The test shell design is intended to evolve and new tests will be required to verify the additions and modifications. These 'special' tests become integrated with the first set. This offers an improved starting point for new applications of the test shell; its starting point being founded upon a proven basis. Finally, the second set of verification tests involve applying the previous criteria to real equipment and comparing with results obtained by performing equivalent tests in a real environment.

The effectiveness of new features is best assessed by a stakeholder group. The group should represent at least sensor domain expertise plus T&E processor architectural and implementation expertise. Although some of these stakeholder skills may reside in one person, it is unlikely that one person would adequately support them all. It has been found that when performing tests with real equipment, unexpected results can arise in any of these areas. For effective communication, the stakeholders need to appreciate each others skills and have overlapping areas. An open-minded stakeholder group is pre-disposed to find solutions for any issues that arise and this should be the aim. Good management techniques need to be

applied to keep the work on this footing and avoid recrimination when problems are found.

The approach taken in this research was to develop a written test procedure that would be reviewed and agreed by all stakeholders. The very earliest stage of a project is the most appropriate point at which to debate the validity of tests, before they are undertaken and when investment of time and money is minimal. It also helps to build the group and create ownership of the objectives. Formal testing was undertaken by executing the test procedure with results being documented. In the nature of these things, not all potential issues will be resolved in this way. Subsequent unexpected results might be traced to a deficiency in the test shell, or the equipment being tested, or the test plan. Once this is resolved, the further tests to show that the issue is satisfactorily overcome are added to the regression test procedure. Regression tests are applied following all modifications. In this way, the test shell's performance is improved on a 'ratchet' basis. An example test procedure can be made available for viewing. This would be on request only because it includes parameters specific to applications.

If the appropriate people are involved, exploring the capabilities of a novel system such as this is a rewarding experience. It goes beyond a formal test procedure. Each stakeholder learns something of the others' domains. Occasionally there is an unexpected revelation in the various skill domains, an example being quoted as part of the ESM verification activities – section 6.3.3.

The dynamics of the group is particularly important when discrepancies between actual and expected results are found. In a group that is badly managed and badly motivated, the outcome will be acrimonious behaviour. This usually results in stakeholders blaming others and defending their own area. However, an effective group will cooperate to identify the cause and each participant will examine their own area as part of the investigation.

In an effective group, all participants experience satisfaction in achieving the objectives that they set out to achieve. The work done in this area, to

verify the concept in the example sensor domains of radar and ESM, is described in Chapter 6.

4.12 A Radar-ESM Architecture

Twenty functions are listed in Table 21 that presents them more succinctly than would be achieved by a list. Their structure is defined in the next section. They represent instantaneous radar and ESM functions required to achieve the scenarios that were introduced in sections 4.4 and 4.5. They represent the main functions required for the research purposes; there are variants of some function to cope with, for example, jammers.

| | | | |
|---|---|---|--|
| Input any UUT control signals that are available | Calculate positions of platform and targets Update Earth-view display | Calculate relative position of platform and targets (range-bearing) | Derive current radar mode, parameters (frequency; waveform; power; beam angle; beam shape) |
| Use relative target to derive features of reflectors and use these to calculate return. | Use position of target to derive radar clutter parameters | Calculate radar clutter returns | Calculate multi-path and obscuration effects |
| Construct time-series return from target and clutter | Modify radar return according to weather conditions | Derive active emitters on each target (ESM) | Apply range equation to calculate ESM power received |
| Apply ESM antenna angular sensitivity to power received | Apply geographic modifiers (e.g. hills), to ESM signal paths | Apply weather conditions to ESM returns | Generate ESM Pulse Descriptor Words (PDW) |
| Use PDWs to generate RF | Monitor any available feedback signals –display as appropriate | Log operational data (including any monitored data) | Output stimulation signals to UUT as appropriate |

Table 21 - Summary of Functions

These can now be structured into an architecture representing the static structure of a stimulation equipment to meet the objectives outlined.

4.12.1 A Radar Implementation

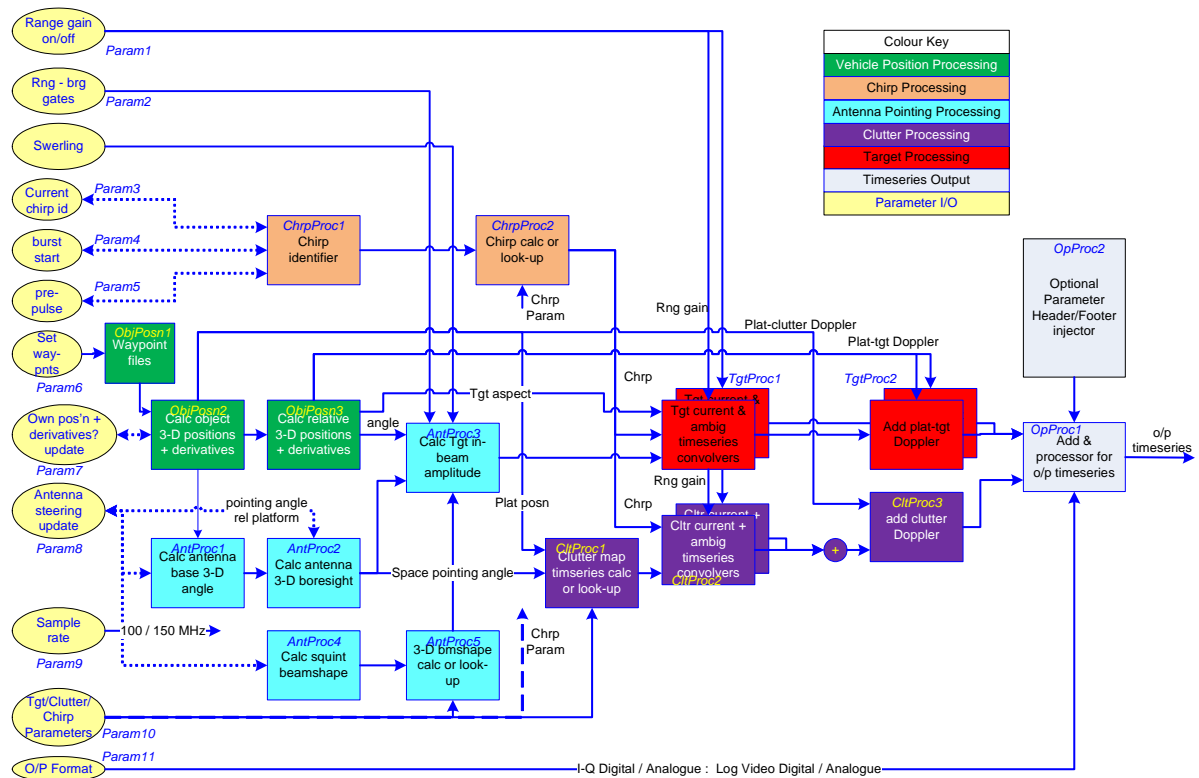

Figure 34 - Radar Base-Band Stimulation Architecture

Figure 34 is a simplified diagram showing a pulsed radar stimulation architecture, the higher-level functionality is shown by the colour-key. The yellow shapes on the left of the diagram depict available parameters. There are two types of parameters in the list; some control operations, these are inputs, for example selection of output format. Other parameters may be inputs or outputs to the system; for example, radar parameters pre-pulse, waveform id etc. If the information is not provided by the radar equipment under test, the parameters are generally provided by look-up tables, these include waveforms and platform position. The look-up operation can be mode related such that identifying a mode (e.g. ground-attack 3) sets a group of parameters.

There are seven colours used in the diagram to depict higher-level functionality that is provided by the blocks with each colour. The yellow area to the extreme left of the figure show top-level parameters that comprise inputs or outputs. In some cases, their direction (input or output)

is selected by an operator, depending upon how much of the UUT is present. An example is antenna steering update (param 8) that can be a set of data delivered to the test shell from a real antenna system, or can be generated by the test shell and delivered to the UUT. It may be required by the UUT, for example, to suppress transmission when the antenna is pointing at superstructure.

The green elements deal with calculating positions of own platform and all targets. This involves reading the scenario control object to determine the required instantaneous speeds and (3D) accelerations of each. The control object may obtain the information from a pre-generated file in CSV format or (to be included), from a joystick control operated by a 'pilot' for own platform. These elements calculate the relative positions (range, bearing, altitude, and aspect angle) of each target to the platform, including the relative radial velocities from which Doppler frequency and target radar reflection profiles are later derived.

The orange elements deal with the transmitted waveform that may change on a pulse-by-pulse basis. The elements select the appropriate waveform by look-up (randomised waveforms) or calculation (series waveforms – such as ramps etc.). Selection is controlled by rules selected by an operator and may, for example, be related to a mode of operation and the number of a current pulse in a burst of pre-defined sequence of pulses. There is an intention to add an A-D convertor into this area so that actual waveforms can be digitised in real-time.

The blue elements deal with antenna pointing angles that can be externally driven (randomised) or internally selected as a simple rotation at an operator selected rate. Internal selection also supports a repeating list of look-angles such as would be used by a phase-array antenna in tracking or identification modes. The antenna angle is converted to spatial angles, according to the heading of own platform, before being combined with a pre-defined look-angle beamshape to define the amplitude of return expected from each target.

The red elements perform the calculations to derive the timeseries and amplitude of return for each target on each pulse. It will be noted that all target returns are calculated, even though some will be outside the dynamic range of the UUT's RF stages due to their combination of range and bearing relative to the own platform's position and look angle. The test shell makes no assumptions about the thresholds that can be detected, all targets at all ranges and bearings are included according to their positions. The elements in this red series convolve the target's shape with the transmitted waveform prior to scaling the amplitude. Phase rotation (due to Doppler) is also added by these elements.

The mauve elements provide the clutter data, a function of current look-angle, which are also convolved with the transmitted waveform and subjected to range and beam-width processing to control their amplitude and phases. This is an area for further development to allow a number of clutter generation algorithms to be supported. It will be necessary to provide land clutter as well as sea clutter. It is intended to link land clutter to the maps of the visualisation part of the test shell. Sea clutter is likely to be a function of wind speed, tide direction and look angle.

Finally, the grey elements combine the clutter and target timeseries data streams (I and Q values) to provide a single output stream synchronised to each pulse's transmission time (with nsec resolution). These elements also include digital to analogue conversion and combination of the I-Q streams to composite video for commercial radar applications. Military radar equipments sometimes combine the pulse I-Q data with a header that includes information about the transmitted pulse. These elements are able to assemble the appropriate parameters from the test shell and insert them, for example during a transmission period prior to the first return. This feature allows UUT processors to be stimulated in a way comparable to that which would be provided by earlier-stage radar processing in the real equipment.

The following text describes the purpose, inputs and outputs of each function, key points are expanded in following sections.

Object Position Processing

Purpose: - to calculate the location of the platform and each target at PRI intervals. This includes calculating the aspect angle of each target relative to the platform and Doppler for clutter and each target.

Inputs:-

1. Waypoints
2. Own platform position and derivatives (speed, acceleration) in 3-D space with roll-pitch and yaw to be added

Outputs:-

1. Platform position (for clutter processing)
2. a set of target identifiers with 3-D angle relative to platform
3. target aspect relative to platform
4. target Doppler relative to platform
5. clutter Doppler relative to platform

Waveform Processing (Orange)

Purpose: - to present the waveform for each PRI interval. This assumes a burst (EXI) of related waveforms where the relationship may be a parametric one (range ramp plus waveform modulation) or a look-up table. A supported trivial case of waveform would be a simple burst of unmodulated carrier frequency. The operation of the proposed system is designed to be initiated by an internally or an externally generated radar pre-pulse. Hence, design changes would be necessary to support continuous wave radars.

Inputs:-

1. burst start
2. PRI start
3. Waveform parameters or look-up data
4. identifier for current waveform

Outputs:-

1. The current waveform complex timeseries

Antenna Pointing Processing (Blue)

Purpose: - to calculate the angle and 3-D beam coverage of the transmit/receive beam. This can have several elements: aircraft attitude, mechanical angle of the antenna and electronic steering angle. As the electronic steering angle changes, so does the beam shape. In some cases, the bore-sight 3-D beamshape comprises 2-Gaussian distributions in azimuth and elevation directions.

Inputs:-

1. aircraft heading, roll, pitch and yaw
2. mechanical angle
3. electronic steering angle

Outputs:-

1. boresight 3-D angle relative to aircraft
2. gain profile (normalised) (is a function of electronic steering angle)
3. gain (absolute) (is a function of electronic steering angle)

Clutter Processing (Purple)

Purpose: - to calculate the coherent return (convolved with waveform) given aircraft position and look angle. It is also a function of clutter patches as well as waveform. Note that the clutter is the sum of range swathes radiating from the aircraft given the angles relative to clutter direction. There will be discontinuities where clutter patch boundaries are crossed.

Inputs:-

1. Range gain (R^4) selection (on/off)
2. clutter patch locations (or look-up)
3. clutter description (or look-up)
4. aircraft position
5. beam shape (gains) over clutter map
6. current waveform
7. clutter Doppler

Outputs:-

1. the coherent clutter timeseries for each waveform, Doppler corrected

Target Processing (Red)

Purpose: - to calculate the coherent return (convolved with waveform) for each target, given its location (bearing and range) and aspect relative to the platform. The outputs for each target (and its range ambiguous waveform-related returns) should be in the correct time location (so it can be added to the clutter timeseries).

Inputs:-

1. Range gain (R^4) selection (on/off)
2. range/bearing gates (turns amplitudes to zero if a real/ambiguous target is outside the gate)
3. target aspect
4. target range gain
5. complex reflectivity coefficients for each target aspect
6. target range
7. waveform

Outputs:-

1. target complex timeseries in correct time registration relative to PRI

Timeseries Output (Grey)

Purpose: - to produce a timeseries output in the required format. The following formats are typical of those commonly used:

1. Time-series I-Q (range/bearing gated)
2. Log video (range/bearing gated)
3. Range/bearing gated headers and footers that include selected parameters (burst No; this PRI number; waveform type etc.)

Inputs:-

1. selection of required output format (as above)
2. clutter time-series
3. target time-series
4. header/footer selection data

Outputs:-

1. timeseries as above

It will be appreciated that these functions will be mapped into the test shell as described in section 4.11.4.

4.12.2 Trade-Off Situations

There are situations in which the processing techniques need to be varied to accommodate the architecture of the system, including making best use of existing hardware or software modules. In other cases, it may be that processing can be greatly simplified if it were possible to relax an aspect of the ideal requirements. This is an Engineering application rather than one of pure science and so these aspects have been considered as described in this section.

Time vs. Frequency Domain It will be noted from the above that some concessions have been made to processing. For example, the calculation of target returns are processed in the frequency domain rather than the time domain described in the previous descriptions. An FFT of the waveform (derived in ‘slow-time’²⁸ from the waveform timeseries) is multiplied by an FFT of the spatial distribution of reflectors (also generated in ‘slow time’ from the spatial and reflecting characteristics) and the result subjected to an inverse FFT to obtain the time-sequence that is used when forming the total returned time-series. A similar convolution technique is used for clutter generation but the size of the FFT is much larger due to the range over which clutter applied being far greater than the length of a target. This approach requires the target reflecting data to be held in a store that defines, for each aspect, the reflecting amplitude, phase and transmission of each reflecting point at distances equivalent to the processing resolution of the radar (in the example 1 or 1.5M). The (apparent) resolution can be increased by interpolation.

Look-Ahead Processing An FPGA operates best with a series of pipelined processes that combine to provide outputs. The disadvantage is the time that it takes for the first values to emerge from the end of the pipeline; subsequent values then emerge at clock-rate speeds (nSec). This latency issue can be addressed by ‘starting early’. For example, no return data can

²⁸ ‘slow-time’ is used here to mean a time outside the period when a scenario is being run and processing time is likely to be at a premium.

be received until the transmitter pulse has been completed; however, knowledge that data are required is available at the time of arrival of the pre-pulse. The time between the arrival of the pre-pulse and end of the transmitted waveform can be in the order of 1 or more microseconds. This allows over 100 (parallel) processing steps to be taken (with an FPGA clock speed as low as 10 nSec) before data are required. The waveform will be known before the pre-pulse arrives, so the convolution of target aspect and the waveform can start early by this look-ahead processing technique.

Inter-EXI gaps All radars encountered during this research have gaps between EXIs. These gaps allow the radar to change to a different mode and the antenna to be moved or re-steered. There is a minimum gap specified and so there is a guaranteed time that can be used for more complex or longer calculations. An example is coherent clutter generation in which each waveform must be convolved with the clutter reflectors in the direction of the antenna's beam (and side-lobes). This is a lengthy calculation but the first waveform processing can start in the inter-gap period, the second clutter map (for the second waveform) can be calculated during the return period of the first transmission and so on for each waveform. In some cases, according to the purpose of the test, it is acceptable to pre-calculate the full set of clutter maps. This applies if the processing is not overly sensitive to changing clutter or relative motion between platform and target is slow.

4.12.3 An ESM Implementation

Figure 28 shows radar and ESM receivers connected to stimulation equipment. Figure 35 replicates the ESM part of the diagram to avoid the need to refer backwards to the earlier diagram, it will be remembered that the scenario generator is shared with the radar stimulator in Figure 28. The yellow parts are the UUT and the blue represents the stimulation equipment.

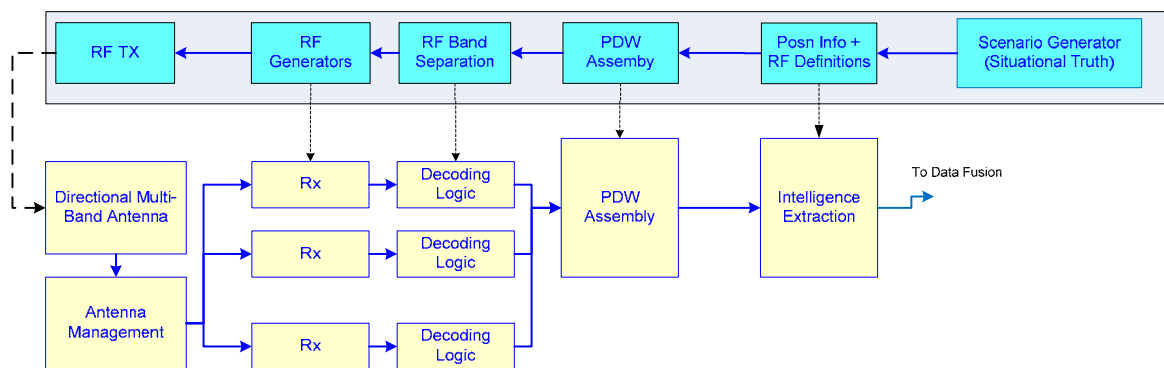

Figure 35 - ESM Test Deployment Diagram

The scenario generator holds information about when emitters on each target are active. The next block to the left of the scenario generator recovers the relative position information from each target to the platform and the RF characteristics of the active emitters. This will define the carrier frequency, modulation type and other parameters used by the next block (Pulse Descriptor Word (PDW) Assembly) to generate a list of current emissions and their characteristics of interest. The range information is used to assess the power (P_r) received at the platform as defined by (1) in section 4.9.2.2.

The RF Band Separation block sorts these into band order for allocation to the UUT's various receiver units. The list of active transmissions can be greatly reduced if knowledge of the frequencies currently being scanned by the receivers is available. The RF generators produce RF from the PDW definitions and these may be injected directly into the receivers or into the antenna as appropriate for the tests being performed.

A similar block diagram to that of Figure 34 could be drawn but it would be much simpler. A more relevant diagram from the UML set is the interaction diagram that is shown in simplified form in Figure 36.

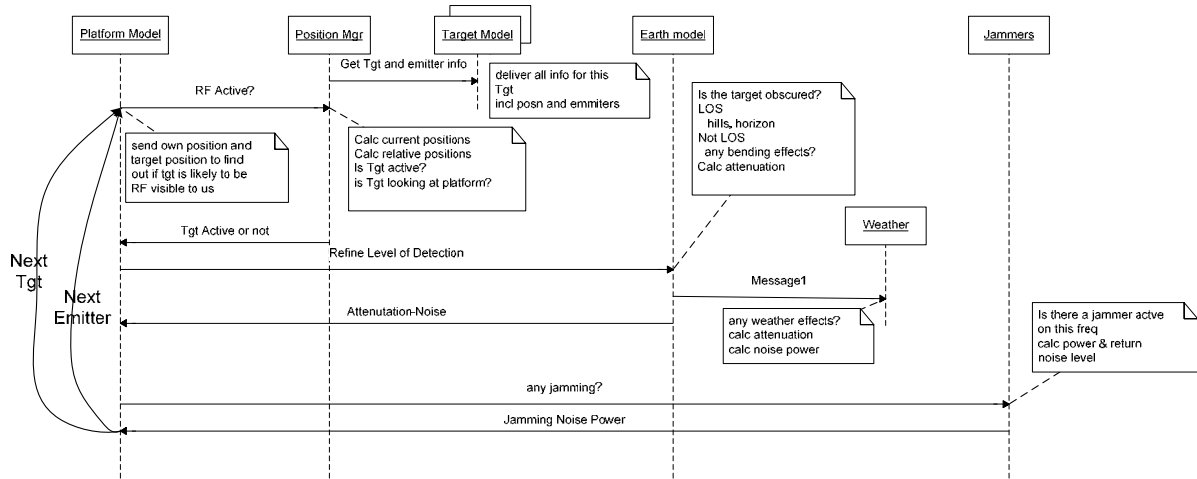

Figure 36 - ESM Stimulation Interaction Diagram

The diagram shows some of the lower-level objects in the model at the top of the diagram, they have dotted lines descending from them. These are called ‘swim-lines’ and they represent time. This allows a sequence of actions to be shown vertically, starting from the top of the swim-lines and progressing down the page. The swim lines are linked by horizontal lines showing interactions between the swim line objects, a comment is associated with each to describe the actions that take place. It is not the intention to describe the interactions in detail, the intention is to show that there is an established way to implement the design required to meet the objectives. There are issues to be resolved that are specific to the objective and these have been considered.

The Platform Model and Position Manager are common to the radar model and the diagram shows that each target is scanned to check which emitters (if any) are active. Steps are taken to check signal modifiers, including LoS before the PDW is formed and the scan moves to the next emitter or target.

4.12.4 ESM Trade-Off Situations

There are two main issues of concern in meeting the objectives, calculation rate and implementing RF signals. Although the calculations required are simple, compared to the radar case, there are many calculations to perform. A target may be carrying 5-15 emitters (HF/VHF transceivers; 1-2 radar systems; height-finder etc) of which 3-4 may be active at one time. There can be several hundred targets in a surveyed area. Assuming 1,000 targets with an average of 4 active emitters each, there are 4,000 calculations to be made per scan of the environment. If this is per Second or per μSec influences the design

Calculation Rate A signal arrival-time resolution in the low μSec region, presents a processing challenge. Calculation results must be presented in time order in their band groups as previously described. This allows some parallel action because they can be calculated in band groups. The receivers in each band will be scanning and so not all emitters will be monitored at any instant. Knowledge of this scanning regime can be transferred to the test equipment to reduce its workload. This is not always an acceptable approach. It is important that the test equipment replicates the real environment as accurately as possible. In this way, unforeseen effects are detected and the tests have more value than simply confirming predictable results.

RF Generators In many cases it is adequate to produce the PDW data stream without generating the RF signals associated with them, (The Royal Navy's Shore Integration Facility (SIF) operates in this way when integrating equipment for use at sea). However, there are occasions, for example when verifying the operation of the earlier stages of the ESM equipment, when it is at least desirable, if not essential, to radiate many signals. This number of active signals requires either many RF generators or fewer broadband generators that can accept complex modulation. Combining the signals for wideband modulation adds to the processing load and this stage of test signal injection requires real-time sub μSec resolution.

A further issue is the radiation pattern of the ESM antennas. To correctly stimulate a phase-sensitive antenna sub-system the test transmission must use at least three transmitting antennas for each signal so that the phase of the signals arriving at the ESM antenna are appropriate for the bearing location of the target relative to the platform. These issues are noted but have not been implemented during this research period.

4.13 Other Sensor Types

This section has established a process that has been applied to Radar and ESM equipment testing.

1. The needs and critical features of the equipment must be identified in terms of their functionality and physical construction (to identify data injection and monitoring points for example).
2. Data need to be available in file-format, as well as real-time, so that the UUT can be tested when it exists only as software or mathematical models as well as being available as an operational system.
3. The range and type of tests need to be identified, particularly aspects of the test data that are important. For example, radar clutter issues would map to thermal noise issues for an IR sensor.
4. The process-flow for the UUT is typically reversed in stimulation equipment (the starting point for the synthetic environment test equipment is the ground truth, whereas establishing the ground truth is the aiming end-point of the UUT).
5. A ground-truth generator should be common to all sensor types so that data fusion is based upon the same ground-truth for all sensors. This may result in a particular sensor not using all of the ground-truth information.
6. The processing load to generate appropriate data needs to be derived and shared between a host PC processor and one or more co-processors as appropriate. In some cases, that require identification, simplifications and 'work-arounds' may need to be identified for the implementation to be practical and cost effective.

This has been applied to the radar and ESM stimulation equipment in this section. Further work is required to apply this to other sensors.

5 Extensions & Exceptions

This section is an extension to the previous chapter and is intended to demonstrate the amount of flexibility offered by the research test shell. This is important because it needs to support a very wide range of sensor equipment options if the intent to be generic is to be met. Foliage penetration and atmospheric diffraction are amongst those features not documented due to space constraints.

5.1 Doppler Effects

Target-platform relative motion is calculated by target objects, as described in section 4.9, to modify target phase returns. If there is relative radial movement between the platform and target, the Doppler Effect will cause a further phase change in reflected energy. If both the target and platform were stationary, the phase of the returned signal would be related to the distance the wave travelled (twice the range between them), such that (5) applies:

$$\phi_r = \phi_t + 2R\left(\frac{2\pi}{\lambda}\right) \quad (5)$$

where ϕ_t = phase of transmitted signal referred to a local standard in the transmitter (radians) and λ = wavelength of radar RF (m) – other parameters as defined previously.

(5) assumes that the reflection itself does not result in a phase change. If there is relative motion between the target and platform there will be a phase change during the transmission period but a more significant one between pulses of illumination (the PRI period). During the PRI period, the relative distance will have changed as described in (6):

$$\delta r = V_D \delta t \quad (6)$$

This results in a phase change as shown in (7):

$$\delta\phi = V_D \delta t \frac{2\pi}{\lambda} \quad (7)$$

where δr = range change; V_D =Relative radial velocity between platform and target (m/sec); δt = time between pulses (PRI – Sec); $\delta\phi$ =phase change (radians) – other parameters as defined previously.

The phase change is accommodated by modifying the convolved waveform-target data set at each PRI so that the relative motion phase change is detected by the radar as being a moving target with a Doppler frequency equivalent to the rate of change of phase between PRIs. The Doppler equation can be used to extract the relative radial velocity as defined in (8):

$$V = \frac{F_D c}{2f_r} \quad (8)$$

where F_D = Doppler Frequency; c = speed of light. f_r = radar frequency (Hz)

Verification of Implementation of Doppler equations was verified by comparing computed results with manual calculations for test cases where the radial velocity was selected for a target. The FFT of the predicted return signal exhibited a spectral line at the correct Doppler frequency. See Appendix I.10.

The above provides a basic radar return generator that is scenario based, however the presence of clutter has not yet been added. Clutter returns are of key importance and are treated as boundary case of range-extended size, where the target has changing RCS patterns between radar pulses. There is more information in section 5.5.

5.1.1 Micro-Doppler Effects

Some targets carry rotating parts (an antenna for example). If the rotation rate of the part is such that it presents the same RCS at each illumination of the target, the rotating part would appear to be fixed. Micro-Doppler

effects (that include JEM (Jet Engine Modulation) lines) are caused by rotating parts of a target being out of phase with the illumination intervals. This causes differing returns for each period of illumination. It is typically caused by rotating antennas or propulsion systems such as helicopter or jet engine blades from which the 'JEM' term is derived. The effects have not yet been included in the test shell but are planned to be implemented by assigning parameters to the location, plane, number and size of rotating elements on each target. The rotation frequency (that could be a function of speed) will be assigned so that the appropriate Doppler frequency is produced by the mechanism described in the previous section. The effect will be to change the amplitude and phase of RCS points on each illumination. This, in turn, will cause additional phase change in the returned signal. This feature has not yet been implemented.

5.2 Multi- Beam Handling

The beamshape is defined in the research test shell by defining the I-Q amplitudes for each azimuth and elevation angle relative to the reference direction of the antenna. There are 4096 steps, covering 360° azimuth and 2048 bits for 180° elevation, that are held in a file. This makes it possible to define complex beamshapes that may not be physically realisable. For example, a monopulse configuration for sum or difference channels can be produced with a single beam and return one channel of data for processing. This would require two beams and two processing channels in a final configuration. This antenna feature reduces the amount of processing needed for early-stage investigations.

Where multi-processing channels are needed, for example sum and difference, it is necessary to duplicate a section of the configuration shown in Figure 34 because the returns to each processing channel will be different. This configuration has not yet been tested.

It will be noted that antenna polarisation can be controlled by suitable values in the I-Q entries for each angular step of the beam definition file. Furthermore, for phased arrays, where the beam shapes differ according to

the steering angle, an alternative to calculation is to use the appropriate beamshape definition file to produce the required dataset. Evaluation of the effect of failures, or re-weighting, of Tx/Rx elements in the array can also be handled by suitable modification of the resulting beamshape.

5.3 Phased Array Antennas

Many modern types of radar used phased array antennas; these have three impacts upon the design of test equipment compared to traditional rotating antennas:

1. Consecutive look-angles can be widely separated and irregularly initiated in time because they are electronically controlled and not dependant upon the physical rotation of the antenna
2. Beamwidth changes with look-angle due to the geometric pattern of transmit/receive modules
3. Direct injection of signals to the antenna requires more stimulation

The effect is to increase the instantaneous workload and response time of the processing for the test shell because the degree of prediction is limited.

Look Angles: Traditional radar antennas have a fixed beamwidth and they rotate at a constant rate. This makes prediction of their look-angle much simpler. Phased array antennas comprise many Tx/Rx modules and are able to re-phase the transmissions from each module to achieve a fast switch of look-angle. External equipment, such as the test-shell, needs to have access to the current look-angle. It cannot be predicted by calculating it from rotation rate and the time the antenna was in the reference position (usually pointing forwards on the platform) as would be the case for a rotating antenna. However, modern military radar equipment uses standard data busses to communicate between operational modules within the radar (see Figure 25 that shows the functional blocks). The test shell can monitor these busses to obtain information about the radar's control commands and can, therefore, respond appropriately. This technique applies to mode changes as well as look-angles.

Beamshape: The relationship between the 3-D beam shape and look-angle is fixed assuming that all Tx/Rx modules are operational and remain so for the duration of the exercise. This provides two options for the test shell:

either calculate the beam shape given the spatial distribution of the modules and the required look-angle or use a pre-calculated look-up table. Either can be done, the first increases the processing load and the second increases the need for rapid access memory – a traditional processing dilemma.

Stimulation: Once the look-angle and beamshape are known, it is possible to inject a signal behind the antenna that includes the appropriate amplitudes and phases of a returned signal. Once the calculations have been made, injection at that point is independent of the antenna’s physical construction – see Figure 29 that shows some signal injection points. However, if the antenna is to be included in the equipment being tested the task is more difficult.

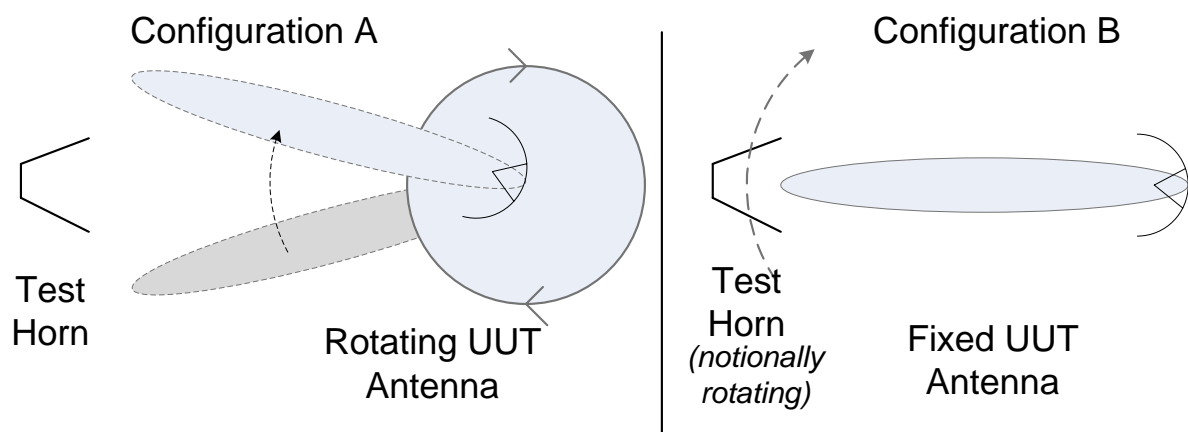

Figure 37 - Antenna in-the-loop Stimulation

A traditional antenna can be included in the test-loop by transmitting a signal from a horn antenna driven by the test equipment as depicted in Figure 37 that is an extension to Figure 29. If the radar system under test (UUT) antenna is rotating, signals can only be injected from a bearing cone equivalent to the beamwidth of the radar’s antenna (Configuration A). However, this does provide, for example, for a training scenario with an attack from a single direction using synthetic targets in the presence of ‘normal’ radar traffic.

If the traditional antenna can be fixed to point at the test horn, although the rest of the system under test believes it to be rotating, a more complex scenario can be emulated (Configuration B). The signal driving the test horn

can be generated as though the test antenna was rotating around the platform, delivering the return signals from each transmitted pulse.

This example using a traditionally rotating antenna can be extended to a phased array but the set-up becomes more complicated due to the change of beamshape of the antenna under test. The transmitting test horn must emit signals from targets (and clutter) weighted according to their relative bearing to the apparent steering direction of the antenna under test. These cases were explored during test applications see sections 6.1.1, 6.3.1 and 6.3.2.

Finally, there is the potential to drive directly the Tx/Rx modules in the phased array of the radar being tested, on an individual basis. This may be done electrically i.e. by removing the module and producing electrical signals, or by very low power RF using a hood over the modules. These options have not been explored during this research period and their investigation remains as future work.

5.4 Mode Changes & Data Transfers

There are a significant number of parameters associated with the operation of the test-shell. These can be conveniently grouped so that the communication between the test shell and other equipment (the unit under test, and possible external control and monitoring equipment) becomes more efficient.

There are 3-categories of parameters

- Those associated with the scenario and so do not change during the exercise
- Those that change infrequently, for example on an EXI basis
- Those that change much more frequently

The complete lists are not provided here, but the first group includes the location on the Earth's surface for the scenario, the number of targets and their capabilities.

The concept of modes, in the sense intended here, was introduced in section 4.9.2.2 and it is explained in more detail here. The mode information

contains those parameters needed to run an EXI and are likely to change from one EXI to the next. As in all generalisations, some borderline cases exist and these are identified in Table 22 as non-mode parameters.

These parameters are transferred as a block transfer and are aligned to EXI start and end. The communication is asynchronous with EXI operation and so a double-buffering method holds data from the last transfer in one buffer whilst the previous data are held in another buffer. The buffers are only swapped at the end of an EXI, however that does not prevent the start of any pre-calculation that is needed, generation of a clutter map is an example of this.

| Parameter | Mode |
|-----------------------------|------|
| Carrier Tx Frequency | Y |
| Transmission Waveform(s) | Y |
| Internal losses | Y |
| Pre-Pulse Delay | Y |
| Pre-pulse delay | Y |
| Pre-pulse external/internal | Y |
| PRI or PRF | Y |
| PW | Y |
| Receiver Gain | Y |
| Resolution – time-steps | Y |
| Rx Antenna Gain | Y |
| Tx Antenna Gain | Y |
| Tx Power | Y |
| Angular Transmit Masks | N |
| Look angle | N |
| Range Gates | N |

Table 22 - Mode Parameters

In addition to the above, there are computed parameters that are used internally and may be needed by external equipment. Target positions are one such example, these can be made available as they are computed, however, they form one set of data that recorded in a scenario log for examination post-exercise. The log is created as a file in the test-shell computer and can be used for post-scenario analysis to determine, for example routes and times of detection. These cases were addressed during applications described in section 6.2.2.

5.5 Clutter Extensions

Early stages of the research were concerned with ground-air, air-air and some space applications where clutter is of less importance than applications that involve ground/sea as a background. This thesis is concerned with providing a framework that will support all aspects necessary to produce a suitable test shell, of which clutter is one. However, in these downward looking applications, arguably clutter is of greater importance than getting realistic target returns because surveillance and tracking applications often work on ‘something that is different to the clutter’ – a quotation from SAAB, without needing it to be of high fidelity. The big issue of these radar systems is to overcome the difficulties imposed by the presence of clutter and locating targets within it.

This issue was not addressed until a later stage of the research and there is still work to be done in this area. However, the architecture can accommodate this as will be described.

Environmental factors that affect clutter include those shown in Table 23:

| Sea Clutter | Land Clutter |
|---------------------------------|---|
| Wind (strength and direction) | Type of surface (foliage, desert, buildings etc) |
| Tide (strength and direction) | Current and previous weather – Precipitation (snow, rain) Wind – produces Doppler from foliage etc. |
| Water depth (and depth changes) | Temperature e.g. ice formation or not |
| Proximity to land | Terrain (flat, hilly, mountainous) |

Table 23 - Clutter Factors

Radar design and operating conditions, specifically the antenna’s 3-D beamshape, height and grazing angle are also important. If the beamshape is wide horizontally, a larger area will be covered and the range-cell returns will result from more spatial integration than if the beam is narrow. The vertical beamwidth (and vertical (grazing) lookdown angle) affect the amount of ground in the return and its start range. This effect can be seen from Figure 23 that shows this in exaggerated form with a high target looking at

long range. If the lookdown angle and/or the height changed, the effect on the amount of clutter and its start range can be understood.

Body of knowledge There are many works available describing clutter distributions. Sea clutter is well covered by the Ward, Tough and Watts IET Publication ‘Sea Clutter: Scattering, the K Distribution and Radar Performance’ [68] chapters 1-7. These authors and others have also produced articles and other works that cover these aspects. Ideally, for this research, there would be a definitive relationship between the elements in Table 23 and the clutter distribution but the research has not located such a work. The Douglas sea state table is reproduced on page 16 of ref [68] (table 2.1), it associates wind speed and duration of the wind condition with wave height. This referenced work also relates water flow, modelled as a sech^2 function over a sandbank (page 60). This research has not so far investigated (or incorporated) the relationship between such effects (if any) and clutter. It remains an open question.

The equivalent book in the land domain is ‘Low-Angle Radar Land Clutter: Measurements and Empirical Models’ by J.B Billingsley 2002 [97], also published by the IET. This relates clutter to a range of weather and environmental conditions, including diurnal and seasonal variations. The Doppler Effect produced by wind-blown vegetation, mainly trees, is addressed, as are a range of terrains from mountainous to urban, including wetland and grassland. Clutter models are offered from the simple to complex.

These elements have not been brought together by this research but their existence is noted. It remains as further work to be done as the commercial importance of these issues increases. The final chapter of ref [68] indicates that clutter parameters are not yet closely linked to weather parameters, so that clutter can be ‘notoriously variable’ for apparently similar conditions (e.g. wind speed or sea state) – see section 3.4.

Implementation The architecture described in this research is modular and object orientated. It is intended that parts can be modified, improved and

adapted to different applications without affecting other parts. This can be seen in Figure 34 where the clutter processing elements are shown in purple. For this flexibility to be achievable, it is necessary for the interfaces, which are accessed by other objects, to be a super-set of the requirements. In this case, the interface parameters include all of those in Table 23 as well as the radar operating parameters.

The clutter map is an important feature of those shown in Figure 34. The architecture supports a wide range of implementations from it being a fixed dataset; through to being mode related to being calculated in real-time as an FPGA function. The process involves beam-width integration of clutter reflectors for each range step (time-step) to form the equivalent of a very long target. The long convolution that results is performed as a series of shorter convolutions that are run in parallel and added together. The implementation work was undertaken by others in the sponsoring company. This was done at the instigation of the author of this research who verified the implementation by comparison of the FPGA results with those obtained by the author's implementation using MATLAB.

5.6 Multi-Path Issues

Multipath effects occur due to reflections, for example from the surface surrounding a target and by refraction in the atmosphere. Their removal possibly rates second to clutter in importance in radar processing. When it occurs, it results in multiple reflections with different path lengths from the target. The reflection and the real target path lengths may overlap to interfere constructively or destructively. If two overlapping path lengths result in a phase change of an odd multiple of $\frac{1}{2}$ wavelengths, the signal will combine destructively. Equal amplitude signals will disappear under these circumstances. This is likely to be a transitory condition, but each side of this exact path difference the signal level will be reduced. The reduction can be such that the signal/clutter level ratio is less than detection threshold and so the target can disappear for a while. It is thought that collisions between small sailing boats and cross-channel ferries could be caused by this effect, an example being a collision between the sailing yacht Ouzo and

the ferry *Pride of Bilbao* Marine Accident Investigation Branch report 7/2007 [98]. In other circumstances, where path lengths do not overlap, a ghost image will be presented to the receiving equipment

Clearly, this is an important feature. It applies not only to RF (radar and ESM) but also to other signal types, particularly sonar. Sonar is subject to sea-bottom and sea-surface reflections and refraction due to temperature ducting. It is clearly important to consider these effects in the test shell. They have not been included so far but the research has pointed to a strategy to address this issue.

It has been described how the transmitted waveform and target reflecting points are convolved and added to the clutter background (section 4.9.2.2 page 141); this is done as a mini timeseries that is added to the main timeseries. A multipath return would take the same form but be delayed and subject to amplitude and phase changes. The exact nature of these changes and, possibly more importantly, the geometric conditions and critical angles that would create multipath conditions have not yet been established as part of this research.

5.7 Improved Target Resolution

The target's shape can be used in its default form from a parameters file entry. This will produce a simple radar cross-section that changes with aspect angle as described by Stimson [99] and others. This simple representation is suitable for some applications including detection and tracking, it is not suitable for SAR/ISAR applications. The research test shell looks for a high-resolution definition file with the same name as the call sign of each object. This is an index to a number of aspect files, each containing an I-Q data set for a single azimuth-elevation view of the target. There would be as many such files as aspect views necessary to define the target with sufficient resolution. The columns in the table define the normalised I-Q contributions to the reflectivity of an incident wave; the rows represent the physical position of each reflecting point in time resolution steps. For example, if there are 11 reflecting points, and the timesteps are

10 nSec, the target is 16.5 Metres deep (11 range steps of 1.5 Metres) from this angle of view.

It can be appreciated that this format supports the building of some complex reflecting structures; the level of complexity can match the needs of each application. There is full control over 3-D viewing angle and the nature of the reflecting points within the outline shape of the object. For detection and tracking it may not be necessary to have such complexity, the default values may be sufficient. However, for SAR-ISAR ((Inverse) Synthetic Aperture Radar) applications this format offers considerable flexibility and is unrivalled by any available real time stimulation equipment that has been revealed during the research.

However, the resolution of 10 nSec is insufficient for many applications so either interpolation, or finer defining steps, is required. There are 3-ways to overcome this.

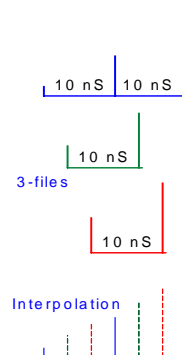

Figure 38 – Improved Target Resolution

1. For each viewing angle a series of files with 10 nSec steps can be imagined, each starting at a different range point – see the top 3 parts of Figure 38. The range value of the target defines the set of data to be used for that transmitted pulse so that the 10 nSec sampling period more accurately matches the reflecting points on the target.
2. The aspect file can be given a finer resolution and then sub-sampled at the required rate of the receiver chain A-D convertor (here 100 MHz).
3. Interpolation can be used to support a resolution to a few cm.

There is further advantage in that the files can be built directly from turntable models of the required target that generally produce I-Q data information in this format. There can be security issues with the representation of targets. Examples would include some antennas or missile launchers that have been fitted to a target. The research test shell will run the same simulation with any set of data that represents a target. This allows those operators with sufficient level of security clearance to work with the target models that have higher levels of classified information, whereas others can use different models without affecting the rest of the operation of the equipment. The files can be changed easily to suit the application. The research included a substantial amount of work to arrive at this format.

5.8 Latency in External Signals

Some issues become apparent when systems of systems are being integrated and latency is a particular cause of many of these. Latency on navigation data is considered here by its effect upon performance also considered is the way that this can be resolved.

Navigation data are used in an operational system to locate the platform so that the relative position (range-bearing) of targets can be converted to geographical positions. This is important, for example, for some weapon systems and for directing other assets to intercept the target, particularly in a crowded area.

Sensor location information (range-bearing) is very close to instantaneous for the platform because it is delivered directly using real-time processing. If there is latency on the delivery of the current position of the platform, the position of platform at the time that the relative will be an old position that can considerably distort the computed position of a target. This is made worse if the platform and/or the target are manoeuvring. This is shown in Figure 39.

The platform's track is shown dotted and the actual range-bearing applied to an old position to provide the (erroneous) computed position of the target.

As successive positions are computed as the platform turns, the position of the target can appear to change very rapidly. This may be sufficient to break a tracking algorithm, resulting in the target being 'lost' so that re-acquisition is needed when the manoeuvre is complete. Not only is that undesirable, it would be uncontrollable if the target is manoeuvring. If the latency is consistent, the error can be compensated once the latency time is known,

Investigating this during design stages is important and it can be built-in to the test-shell by delaying the true platform position before it is delivered to the unit-under-test. This was undertaken for a helicopter radar application and a variable delay added to the user controls. The customer reported that the feature worked well.

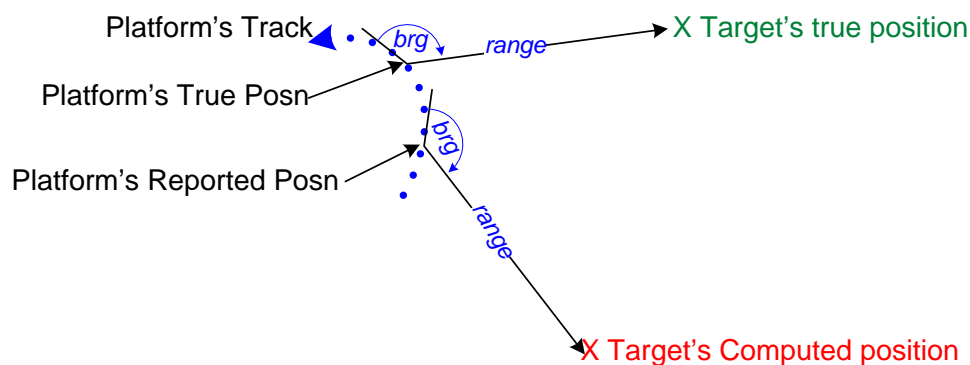

Figure 39 – Effect of Navigation Data Latency

5.9 I/O Issues

The purpose of the proposed test shell is to allow software and hardware to be stimulated with data. Radar data are computed as I-Q pairs or a composite signal for these to be transferred to the unit under test (UUT) clearly requires the data to be in a form appropriate to the UUT. The calculations, performed in parallel digital format, may need to be converted to another format for compatibility with the UUT.

This applies not only to the radar timeseries (I-Q pairs) that are output signals but also to other signals, some of which may be inputs, pre-pulse radar trigger is an example. These input/output (I/O) signals require a

range of convertors to be available so that analogue or serial digital formats, including fibre-optic, can be supported.

Such I/O convertors may be special to the application but they form a small part of a system that is otherwise generic.

5.10 Radar Frequency Control

The research implementation used a laboratory instrument from Agilent to produce RF signals (the radar returns) the amplitude, phase and frequency of which are controlled by the test-shell.

It was found that all but the frequency could be controlled readily and in real-time, an essential feature. However, significant frequency change, greater than could be controlled by applying offset Voltage to an oscillator, required a few 10's of mSec to allow the circuits in the RF generator to stabilise.

If a significant frequency change were to be required during an EXI, or if the inter-EXI period is shorter than the RF generator's stabilisation period, the real-time response cannot be met. This problem was not resolved but regimes for addressing it have been discussed with Agilent and potential users. There are 2 categories of usage:

- 1 It does not matter because it is possible to stay within low frequency changes for each 'experiment' with the UUT. If large changes are required, these can be considered as two experiments.
- 2 It does matter and an RF generator is required for each RF frequency band to be used. All generators are driven with the same modulating data and the appropriate one selected, by an external RF switch, for the frequency band required.

5.11 Data Fusion Issues

There are no special issues relating to data fusion that are not covered by close adherence to replicating the physics of the scenarios. This will ensure that timings, geographical locations and correct aspect depictions of targets will stay consistent across the domains involved in the fusion (radar, ESM EO/IR etc.).

5.12 Scenario Building Issues

A number of issues have not been fully addressed by this research and they remain open for further work. Most have been described in this and other chapters. The research has been aimed at covering issues thought by the author and domain specialists who contributed to the work, to carry the most risk and to offer the greatest threat to the concept's viability.

Scenario building for the research work was achieved by data entry into a spreadsheet to define geographic locations, radar and ESM parameters and performance of vehicles (maximum speeds, accelerations etc.). This is not a visual way to address these issues and runs counter to the main objectives. However, it was understood by the stakeholders to be a comparatively simple aspect with low risk. Military, and those stakeholders with a less technical bias, find the current approach a challenge and suggestions about setting up the platform and targets on Google Earth, with waypoints entered graphically are amongst those that have been gratefully received.

At a larger scale of integration, at the time of writing, a proposal is being considered by the MoD to integrate this physics approach with the 'serious games' approach to link the best aspects of both.

5.13 Data Recording

Data recording would allow a scenario and responses of the UUT to the stimulation described here to be recorded. One argument suggests that recording is not necessary because the scenarios can be re-run at any time. However, development of the UUT means that the scenarios will not necessarily be run with the same UUT as previously. In such cases recording could help to evaluate modifications to the UUT.

This is partially addressed by the research test shell taking and filing a snapshot of all operational parameters for each scenario and storing these with the identities of the necessary set-up files. It would also be possible to record the raw stimulation data for subsequent replay and analysis, as for a traditional trial or laboratory-based test.

Data recorded during real trials are an invaluable source of data. Setting up scenarios to emulate the trial conditions is a way to verify results from this test shell. Obtaining access to such recordings proved impossible for commercial reasons.

1. There were timing issues
 - a. The UUTs were not able to partake in real trials when this test shell was being used
 - b. The UUT was not available for laboratory tests following live trials during which recordings had been made
2. There were commercial and/or confidentiality issues
 - a. The cost of live trials is very high – especially when military vehicles are involved – companies are not inclined to make the data freely available
 - b. The cost of trials (and therefore ownership of the data) may belong to the MoD – when approached for access to specific data for which the radar was accessible, they declined
 - c. Examination of test data results can provide more information to a subject matter expert than might be intended – for example information about performance of phased array antennas could be derived from a scan containing target data

This situation was resolved by employing suitable subject matter experts who have experienced many live and virtual situations within the domain of their expertise. They can compare current results with many previous ones, arguably offering greater value in this way than by an assessment of static data. In the opinion of one such person from Selex, this removes the risk of a set of results being tuned to a particular test case. The assessments included dynamic ‘what-if’ elements. Changes to the test conditions were made to ensure that the equipment being tested responded as the subject matter expert(s) would expect (frequently, several people were involved in each test). Subsequently, the subject matter experts listed the technical features they had examined and provided a written and signed declaration of their satisfaction. These endorsements are available on a confidential basis to the Examiners. The following chapter describes the tests that were undertaken.

6 Verification

It will be appreciated that there are 3 aspects to this work:

- A technically based test shell that produces data that a platform would expect to receive at any place on the Earth, electromagnetic energy (either passively (ESM) or supplemented by energy emission (radar))
- A view of the location showing deployment of energy sources and reflectors (targets etc) - Visualisation
- A delivery mechanism for the above that is likely to be acceptable to all stakeholders (mainly DE&S, prime contractors and SMEs) in a way that meets government objectives for supply chain management

This section sets out the work done to verify the claims for the proposed approach. The ideal situation would be to have a single project from its inception to in-service stages of its lifecycle and show how the combination of the proposed test shell, visualisation and devolved T&E structure performed at each stage. However, this is not practical for two reasons; firstly, the timescale for a typical project is too long, typically 10 years or more. Secondly, it is not practical either to use a new and previously untried method as the sole mechanism for project delivery or to run the new and existing methods in parallel.

However, what has been achieved is reference to 6 mini technical applications where the proposed approach has been evaluated for various stages of the CADMID cycle. The first two of the three aspects are covered in this way. The third aspect is addressed in this section but is on going. Much of the period of this research was one of austerity with programs abandoned or in a state of uncertainty. In these cases, the project did not proceed. Some work has been extended because the projects are still running.

Confidentiality issues are associated with the applications, many of which are at a leading edge of technology and therefore commercially, if not

militarily, sensitive. Non-disclosure and similar agreements are in place for all of the projects and so a separate document containing relevant information can be made available on a 'need to know' basis.

There is a wide range of applications, each with differing priorities in terms of what features are important. In the words of the main technical contact for application 2, *'it is not necessary for the test shell features to be a perfect representation of reality, but they do need to be adequate in those areas that matter to the project'*. Defining 'adequate' is not always simple, especially when a number of stakeholders are involved. The most difficult situation arises when there are several technical specialists involved. The approach, to achieve an effective group as summarised in section 4.11.5, included discussion with all stakeholders to:

- Establish what was being sought and what would constitute a good outcome
- Establishing expectations of what the test shell could and could not do – either totally, or at its current stage of development
- Establish who would be responsible for which aspects – including access to equipment, setting up time, familiarisation time etc.
- Document and agree the above

In some cases, this involved further development of aspects of the test shell.

Table 24 shows the profile of features that were deemed, by other stakeholders, important for each application. In the table, 1 indicates high importance; the addition of a 'd' indicates a desirable feature. In many of the 'd' cases, particularly where changing mode or some other parameters was involved, it was considered acceptable to use multiple tests to cover the cases.

Some issues were not thought to be important because only one stage of the lifecycle was being considered, whereas they would otherwise be more important. Detection indication is used to mean that the test shell is required to indicate a feature of the real radar being displayed by the test

shell. In App3 it was tracking information not target detection. Phased array support includes beam shape modification according to beam angle.

| RF Feature | App1:- Nasar | App2: Naval Helicopter | App3:Fighter a/c | App4: Naval Radar | App5: Type Approval | App6: ESM |
|------------------------------|-----------------|---------------------------|------------------------|-------------------------|------------------------|--------------|
| Platform/target motion | 1 | 1 | 1 | 1 | 1 | 1 |
| Transmitted waveform clutter | 1+ | 1 | 1+ | 1 | 2 | 1 |
| Tgt shape fidelity | 1 | 2 | air-air 3 other 1-2 | 2 | 1 | N/A |
| Doppler | 2 | 2 | 2 | 2 | 2 | N/A |
| Beamshape | 2 | 2 | 1 | 1 | 2 | 1 |
| Multipath | 2 | 1 | 1 | 1 | 2 | 1 |
| Weather | 2 | 3 | 3 | 3 | 2 | 3 |
| Coherent returns | 1 | 3 | 3 | 3 | 1d | 3 |
| Large number of targets | 3 | 2 | 1 | 1 | 3 | N/A |
| Multi-mode operation | 3 | 3 | 3 for most modes | 2 | 2 | 1 |
| Recording results | 3 | 2 | 1d | 2 | 3 | 2 |
| Multiple injection points | 1 | 2 | 2 | 1 | 1 | 1 |
| Freq agility | 2d | 2d | 2d | 2d | 2d | 2d |
| Swerling | 3 | 3 | 2d | 3 | 3d | 1 |
| Jammer active | 1 | 1 | 1 | 1 | 1 | 1 |
| Rng &/or Brg accuracy | 3 | 3d | 3d | 3d | 3 | 1 |
| Sync to real radar | 1 | 1 | 1 | 1 | 1 | 1 |
| Freq agility | 2 | 1 | 1 | 1 | 1 | 1 |
| Power agility | 3d | 3 | 3d | 3 | 3 | 1 |
| Antenna steering | 3 | 3 | 3d | 3 | 3 | 1 |
| Brg sync with real antenna | 3 | 3 | 1 | 3 | 3 | 2 |
| Detection indication | 1 | 1 | 2 | 1 | 1 | 1 |
| Tgt obscuration | 1 | 1 | 3 | 3 | 3 | 1 |
| Landmass depiction | 3 | 3 | 3 | 3 | 3 | 3 |
| Polarisation | 1 | 3 | 3 | 3 | 2 | N/A |
| Multi-ch op | 3d | 3 | 3d | 3 | 3d | 1 |
| Roll/pitch/yaw | 3d | 3d | 2d | 3 | 3 | 3 |
| Micro Doppler | 1+ | 3 | 3 | 2d | 2d | 3 |
| Phased array | 3 | 3 | 3d | 3 | 3 | 1 |
| Rng/Brg gating | 3 | 3 | 1 | 3 | 3 | 3 |
| | 3 | 1 | 1 | 1 | 2 | 3 |

Table 24 - Parameters of Importance to Stakeholders

6.1 Concept and Analysis stages

One project is described in this part of the lifecycle.

6.1.1 Application 1: NASAR an MoD project

This application illustrates a commercial construct that could apply to the implementation of the concept. It also scopes a technical involvement.

Overview: This naval project is intended to supplement/replace existing ship navigational radar equipment with the ability to detect small craft in rough seas. Naval vessels, like any others, are subject to rules of navigation for harbour entry and departure. They must also maintain safe navigation of shipping lanes. Their additional needs are, for example, to engage air and sea targets. For example being able to detect inflatables at as great a distance as possible, is one that would increase situational awareness. Merging these functions offers a reduction in weight, power and manning capability. Extending the capability of traditional navigation radar equipment to improve detection capability in rough seas would address the need to detect inflatables. That is the navigational and situation awareness (NASAR) objective.

The project was run by a Project Team in Abbey Wood and discussion with them led to an agreement to run the test shell and its visualisation capability for the purposes of an assessment of bidders' offerings.

Objectives: DE&S had issued a provisional specification and, of the companies that had expressed interest, 4 were down selected for an assessment phase. The original intention was to allocate time on a naval vessel to each company for this purpose. DE&S and the companies were both sensitive to the issue of providing a comparable set of weather and trial conditions for each assessment period. The proposed solution offers a resolution to this issue. DE&S invited comments from these companies and all agreed in principle, each with understandable reservations. The companies concerns included:

1. The need for confidentiality about their offering – it should not be shared with other bidders (or DE&S, without their permission)
2. The nature of the proposed assessment tests (scenarios) – this resolved to ensuring that their offerings were exposed to conditions that they felt gave them a technical advantage
3. The fidelity of tests i.e. verification of the test shell, that it replicated the specified weather conditions, sea-states, ship motion and target features in an adequate and appropriate way

Involvement: The author of this thesis met each of the companies who disclosed information about their offering and the way in which they planned to meet the objectives. This was done under confidentiality agreements to meet concern 1 above. The visual approach was understood by all. The general requirements are summarised in sections G.1.1 and G.1.2.

Concern 2 was addressed. Each supplier offered specific features to meet certain sea and ship motion conditions. They required that any assessment should include conditions that would exercise these specific features to best advantage. They wished to assess the test cases (scenarios) with their radar equipment prior to the DE&S assessment.

Concern 3 was discussed with all parties and the way it was addressed is discussed below. It led to The RTDC submitting a commercial proposal to the MoD. The proposal included assisting with the production of an Integrated Test Evaluation and Analysis Plan and providing manpower to set-up a test shell to produce agreed scenarios.

The test shell would be set-up with radar parameters (transmitted power, waveform, frequency, beam gain and shape etc.) for each bidder's radar equipment and the results would be compared for:

- Detection range
- Tracking capability
- Identification capability

The RTDC would liaise with Dstl to ensure that the scenarios were truly representative of situations at sea concerning clutter, multi-path and other features appropriate to the proposed tests. Note that multi-path reflections are not currently included but are part of the development road-map, with other features, for inclusion as needs for them arise.

The test shell, with similar, but not the assessment scenarios, would be made available to all suppliers prior to the assessment so that they could verify the results against their own expectations.

It was also agreed that test shell would be made available for 4 weeks to each of the bidders prior to the assessment. The test shell would be delivered to them using similar, but not identical, scenarios to those that would be used for the assessment. In addition, The RTDC would work with each company, comparing real or recorded data from their radars operating in a variety of (documented) conditions (scenarios). The scenarios would result in the test shell producing synthetic radar returns that would be applied to that company's radar. The RTDC would make any adjustments necessary to achieve agreed comparability between the real and simulated scenarios. This was intended to allay concern 3 and provide a baseline set of test conditions acceptable to all stakeholders.

Each company would then run the pseudo assessment criteria and make any adjustments they wished to make. The 'real' and documented assessment would be witnessed by DE&S, possibly Dstl, using the assessment scenarios agreed between Dstl, DE&S and The RTDC.

Contribution: This work was useful in developing a template for a working relationship between DE&S, Dstl (DE&S technical advisors) and the bidding companies, with an SME providing the assessment capability. It is very unfortunate that the project was abandoned and its future is still uncertain. However, it confirms that the test shell promises to be a useful tool in assessing the relative merits of bids in the competition phase of procurement. The work suggests that the concept could be considered, as

intended, for acceptance testing, by helping to ensure that the customer receives what was ordered.

6.2 Design Stage

Two projects are described for this part of the lifecycle.

The first of these illustrates how the concept can reduce the cost of final acceptance testing. It also illustrates how it can support further investigation when unexpected results emerge from the extended test capability that the test shell offered.

The second application in this group illustrates that all skills to produce a working test shell need not reside in one place. The skills of radar specialists were harnessed to populate the technical framework of the test shell with algorithms appropriate for the task-in-hand. This work has achieved initial success and it is being extended to applications that are more complex.

6.2.1 Application 2: Naval Helicopter Application

Overview: This application is associated with an export project to provide an air and sea coverage surveillance-radar system for naval helicopters. The project was nearing its end and issues associated with performing appropriate acceptance tests emerged. Live tests were performed at a roof laboratory using a fixed antenna on a platform that was obviously not moving. The targets were largely commercial aircraft following steady paths into a nearby airport. This test shell was used to extend those tests to provide a moving platform and targets that had the freedom to move under users' control and in more challenging ways. The test shell was used to investigate some unexpected target tracking results that were observed during synthetic and live testing.

Objectives: - The test shell was required to help verify range and bearing calculations. It was later used to explore issues that emerged due to latency of navigation data delivered to the radar's track processing equipment. This

was prone to losing track during certain manoeuvres of the platform and/or target.

Test Shell Involvement: - A -R test shell (a variant to support radar) was used to extend the tests already performed live from a roof-lab using a real radar and targets of opportunity. Much work was undertaken to verify the operation of the test shell concerning the following

- **Target and platform motion** – to ensure that macro motion (over several hours) and micro motion (pulse to pulse timings) were such that the platform and targets followed appropriate paths when travelling in straight lines or undergoing acceleration in 2 planes. A range discrepancy was observed when synthetic and real returns from reflectors in accurately located positions were compared. This was traced to the velocity of RF signals at the test altitude being different to the speed of light in a vacuum used by the test shell. The speed of light used in the calculation was modified to 299792458 m/sec (from 300000000 m/sec). Applying this correction caused the test-shell range markers and real features to align.
- **Calculation of relative motion** – to ensure that the relative range, bearing and radial velocities were accurately calculated on a pulse by pulse basis
- **Very basic clutter effects** – to show that more complex clutter generation had a ‘placeholder’ for later inclusion into the test shell – see Figure 34. At this stage, these signals were not convolved with clutter.
- **Sensitivity to pre-pulse variations** – to show that the timing of the ‘transmitted pulse’ was accurately synchronised to the time that the radar processing equipment expected the pulse to be transmitted. (Clearly, the synthetic environment does not require an actual transmission but the returns are referenced to this signal). The stability and accuracy of the pre-pulse affects the range calculation of targets. Any jitter or offset on this signal would cause target positions, as perceived by the radar, to jitter or to be offset in range. A 1 nsec jitter would cause an apparent range jitter of 0.3 metres.
- **AGC accuracy** – test shell AGC can be optimised for a selected range so that signal returns are within the dynamic range of processing equipment. Alternatively, AGC can be turned off. In the test shell, the

AGC can be selected to be 'perfect' (same dynamic range for all physical distances) or obey a rule based upon a selected range or be turned off.

- **Range gating accuracy** – the amount of data delivered to the radar's processors can be limited by range and/or bearing gating. That is arranging to transfer only data from a number of 'boxes' defined by two ranges and/or two bearings. The bearing selection is not applicable to steered arrays. This check measured the accuracy of such selections.
- **Bearing blanking accuracy** – is used to prevent radiation in sectors where it is not required. This may be to avoid radiating parts of the platform or areas of the earth (for tactical reasons).
- **Beamshape effects on target return amplitude** – radar beam shapes are such that some radiation can occur outside the defined beamwidth (3dB points). This check was used to verify beamshape performance by measuring the amplitudes of target returns over 360°.
- **Ability to apply a selection of waveform values** – these can change on a pulse-by-pulse basis and some processing relies upon appropriate waveform – target returns. This is necessary to identify range ambiguous targets for example.

The test shell performance was exercised in each of these categories. The verification method and results are presented in Appendix H where it will be seen that satisfactory results were obtained.

The customer designed and entered scenarios to extend the tests that had previous been performed live from the roof lab and used to verify the test shell. This work led to further examination of latency in delivering navigation data to the radar, resulting in tracking errors as previously described. An addition to the test shell was made to make the latency a variable factor. This was achieved by the reference positional information being delayed by a variable time. The test shell used the reference information and the delayed information was delivered to the radar processing equipment (as in the aircraft configuration).

The test shell was then used to demonstrate the issue to the relevant department in the customer's organisation. In addition to displaying the true position of targets on Google Earth, the test shell supports display of reported positions. During manoeuvres involving rapid turns, the true and reported positions deviated to such an extent that not only was it visible, but tracking could be lost, as explained in section 5.8.

Contribution: this application was the first to be undertaken with the test shell. It provided confidence in the concept and implementation of the basic algorithms that were evaluated. The more complex algorithms, including clutter generation, can be readily changed to resolve any discrepancies. The important factor was that the architecture was adequate to support real-time delivery of signals in a way that was acceptable to this radar and its developers.

The test shell produces a log of all parameters at one-second intervals throughout the scenario. However, the visualisation facility proved to be valuable for illustrating the issues that had emerged. The visualisation facilities were also demonstrated to other project stakeholders who confirmed that it helped in understanding the complex issues that are encountered.

6.2.2 Application 3: Fighter Aircraft Application

Overview: This airborne multi-role radar is required to support air-to-air, air-to-ground and air-to-sea modes. Its operation in each of these areas includes surveillance and attack modes of various types. The research nature of the project results in it carrying commercial classification. The nose-mounted radar used a phased array antenna with some mechanical steering capability relative to the airframe. The mechanical steering allows the aircraft to monitor a wider viewing angle than can be achieved by a solidly mounted phased array antenna. A fixed, sideways looking, array was used during development stages. This was mounted on a larger aircraft so that technical personnel were able to monitor operation during test flights.

Although presented as a single project it was actually two. One part took place with supplier 3a directly and the other with their partner 3b. The two engagements took different, but interacting, paths that are presented here as one because of their close relationship.

Objectives: The objective was to provide synthetic test data to support exploration of illumination modes and analysis of air-air and air-sea modes of operation. There are many operational modes, each with different waveforms, transmission power and PRF. Each of these comprises at least one pulse-burst execution interval (EXI) during which time the waveform can change.

It was found that, for each application, there is a different importance-profile requirement for the test shell's features. In this case, the algorithm developers were interested in fidelity of clutter and target features in relation to waveform and beamshape. Other developers placed more importance on timing of returns, response times and latency. In addition to these engineering areas of interest, managers tended to place importance on flexibility and features that would support future developments or other projects. Support for SAR processing was one such area of secondary interest.

Involvement: It was agreed that a number of areas of interest would be identified for current investigation, provided that there could be shown to be a convincing argument that the other areas could be addressed. It was found that this profiling was less stable than originally intended as external events unfolded and interacted with the current developments. Other projects and extensions of the current application were two such external factors.

The involvement of this research was limited and ran in parallel with 'normal' development, this enabled comparisons to be made and these are discussed at the end of this section. Some aspects are still running as will be described later. The situation was (and still is at the time of writing) complex and dynamic. However, this thesis isolates some technical areas for further presentation of capability that was explored by this application. The radar parameters that are presented were used for demonstration purposes and should not be taken as being related to any radar.

Basic EXI operation. An Execution Interval (EXI) comprises a defined number of radar pulses. Each pulse can have an individual waveform. In this case, the carrier frequency, PRF and power were fixed for the EXI period. An EXI was associated with a beam pointing direction and beamshape. Target returns are expected from in-beam directions according to the beamshape and the relative angles (and ranges) of the targets. Range ambiguous targets were expected, bearing ambiguous targets were of less interest in this application. For some experiments, range dependent amplitudes were required and for others they were not required because the injection of test signals was post automatic gain control (AGC). The relative amplitudes of clutter and signal varied in their relevance according to each experiment.

Parameters for the next EXI were made available towards the end of a current EXI. In this application, the lengths of time of the gaps between EXIs were not critical and extended time could be used by the test shell, although this extension was found not to be necessary. The gap is used by

the radar to set-up for the next EXI, providing time for the test shell to do the same.

Figure 40 depicts the configuration of an aircraft with a sideways looking antenna. There are three targets in the beam direction. Two EXI transmission bursts are depicted. One has a PRF that allows the three targets to provide unambiguous range returns. The second EXI uses pulses with a higher PRF and the target at furthest range provides an ambiguous return. The PRFs are 10 kHz and 15 kHz resulting in maximum non-ambiguous ranges of approximately 15 km and 9.9 km respectively. The non-ambiguous range is dependent upon the speed of light (more correctly the speed of an RF signal) in air. That is a function of the atmospheric conditions and frequency in use. It varies from the value in a vacuum as was experienced in the tests performed during the application described in section Figure 40 (see page 209). The table in Figure 40 shows the ranges and radial velocities of the three targets. The negative radial velocity of target 2 indicates that it is approaching the radar platform.

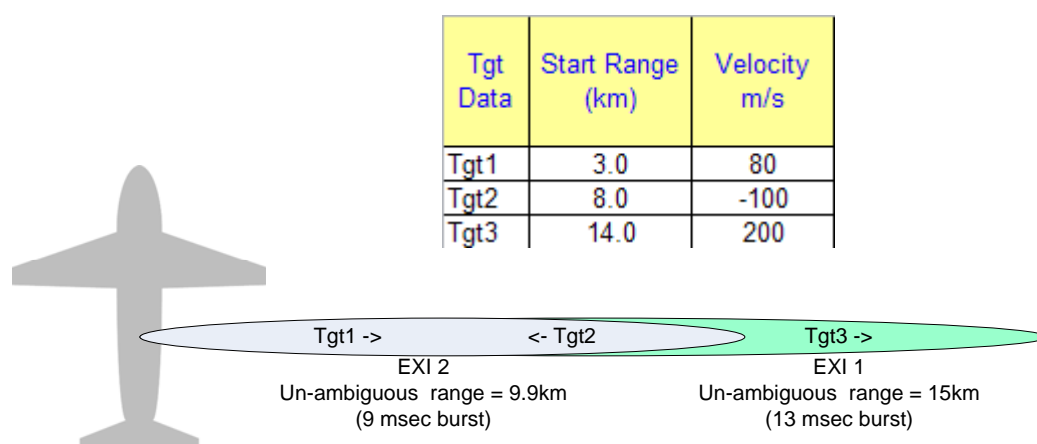

Figure 40 – Side-Scanning Radar

The first EXI comprised 131 pulses with a waveform as shown in Figure 41 and the second EXI comprised 134 pulses with the waveform shown in the same figure. The first waveform comprises 100 samples and the second 91 samples.

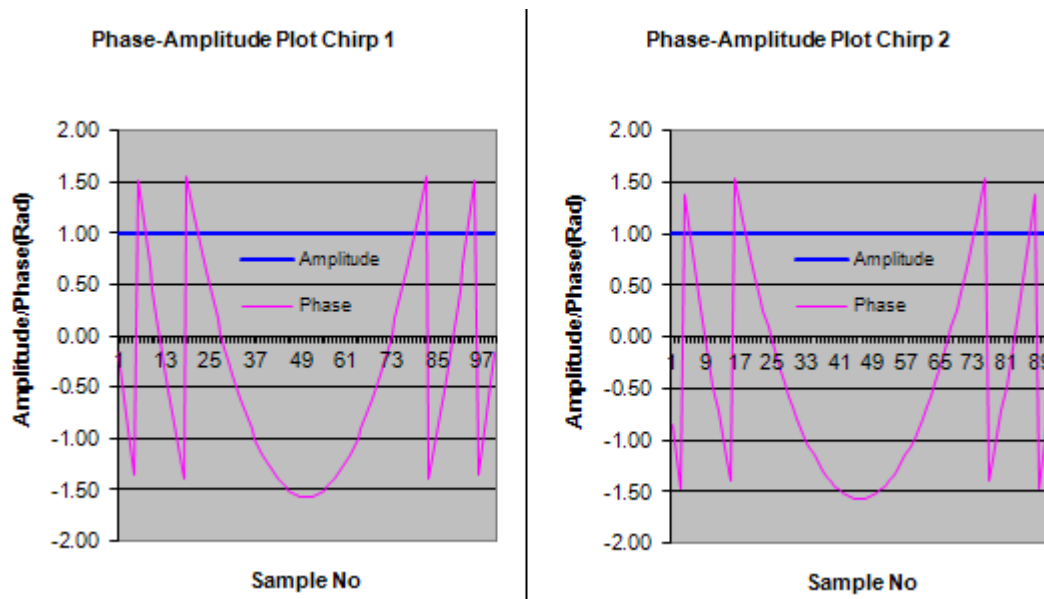

Figure 41 – Transmitted Waveforms

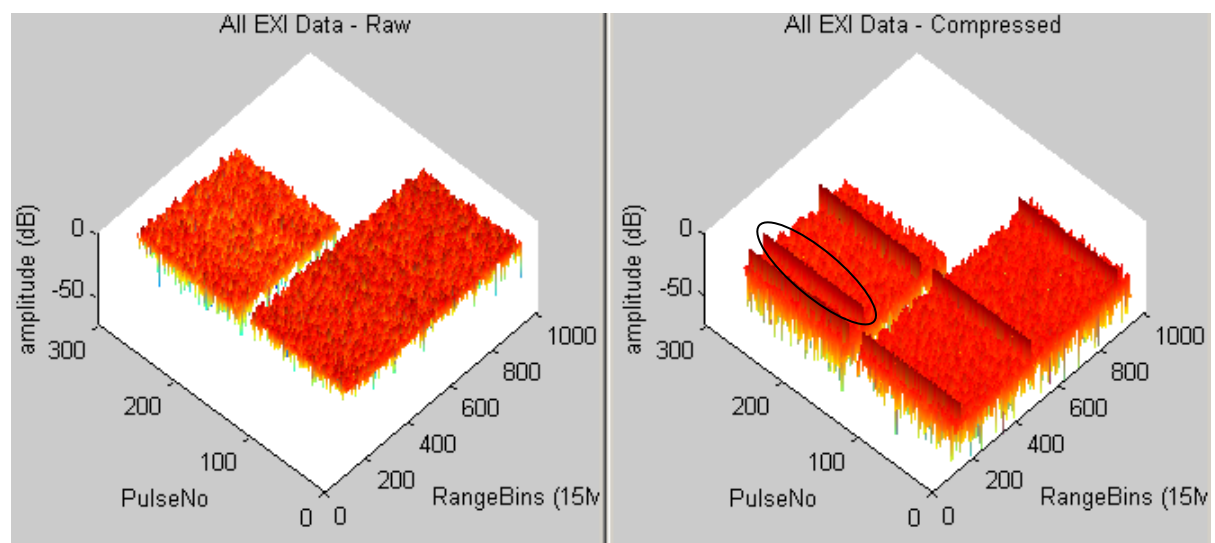

Figure 42 – Raw and Compressed Data

The resulting returns produced by the test shell are shown in Figure 42. The left side shows the test-shell’s base-band output of targets convolved with waveforms for each EXI. Pulse numbers and the inter-EXI gap can be seen. Range bins (in this case 15 m each) can also be seen. The right-hand diagram is the compressed version of the raw return. The targets are visible in this presentation. The range ambiguous target can be clearly seen close to the start of each PRI, and circled, in the second (furthest) EXI. The targets have a small number of complex RCS points. These diagrams were

produced by using a file output facility from the test shell and plotting the results using MATLAB. Normally, these signals would be applied in real-time to a suitable point in the radar processing chain, for example a processor at the output end of an IF amplifier.

Processing these data are functions of the radar being tested. It is at this point that information becomes more restricted due to users' commercial sensitivities. MATLAB was used by the author to emulate the results that were obtained by users. This processing is not part of the test shell's functionality.

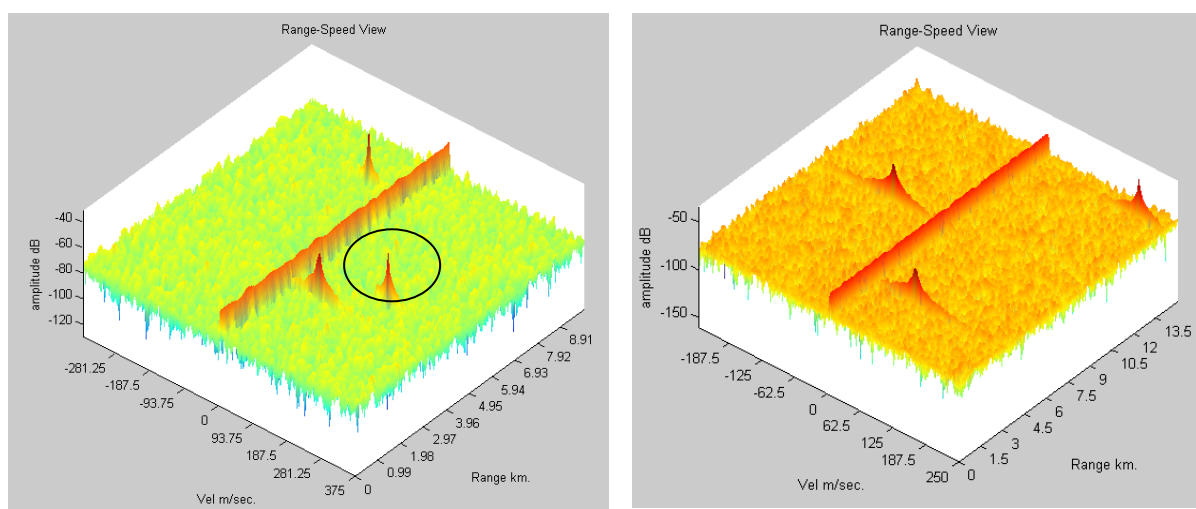

Figure 43 – Doppler Plots – 2 EXIs

Figure 43 shows two Doppler plots, each showing 3 targets. The first EXI is depicted on the right to correspond with the sequences shown in Figure 42. The range and radial velocities of each target can be read from the original plots, it is difficult to do this with these prints. (It will be remembered that Figure 40 shows them with positions of 3, 8 and 14 km and velocities of +80, -100 and +200 m/sec.). It will be noticed that the maximum velocity and range are different for the two EXIs as would be expected because of their different PRFs. The range ambiguous target can be seen in the left-hand plot (circled). It has a range of 4 km and velocity +100 m/sec.

Target Detection in Sea Clutter: Sea clutter was an area of interest to those involved with algorithm development in this application. A simple Weibull model was implemented and further work is necessary to improve

the clutter representation. Ideally, multiple clutter areas will be implemented in the area of radar coverage, related to weather conditions (particularly wind and tide strengths and directions) and depth of ocean.

The timing issues, specifically pre-pulse to transmission delay (that determines range calculations) were adequately met. Inter-EXI gaps were of interest to one group and could be achieved (as shown in the plots). Algorithm developers were able to accept any size of gaps because they were processing each EXI individually at the time of these tests. However, more work is needed in the clutter representation to meet their further needs. Specifically, the Doppler footprint will be skewed and extended as the look angle increases to include more forward/backward spatial coverage and the beam width degrades (increases).

Contribution: This work: The application was probably the most challenging so far and much benefit was gained from it. The test shell coped with the requirements. It identified that further work is needed in some areas. However, the additional work is required to improve the implementation, not to meet concept inadequacy. The RTDC are funding some extensions to the clutter, Doppler and other features with supplier 3a providing some 'unofficial' comparison of results from test shell vs. results from real-world recordings. This is extremely useful in guiding direction of development to produce convergence with real results. Supplier 3b's technical personnel are also contributing to the technical discussion, particularly concerning waveforms, illumination dwell characteristics and associated demands upon test equipment. This will allow complex operational scenarios to evolve and influence, positively, the role of the test shell in training applications. More complex waveforms, particularly those that change during an EXI period, have been implemented. They are not shown here for confidentiality reasons. Not only are the waveforms confidential, showing the results obtained by using them would infringe confidentiality. Omitting this implementation detail does not substantially detract from illustrating of the conceptual capability of a test-shell as described here.

6.3 Manufacturing Stage

Three applications are presented to illustrate the role of this concept during the manufacturing stage of CADMID. The first application extends application 2 and further illustrates a commercial construct that is a variant of that proposed. The second application shows how the concept could be applied to assist with achieving type approval for production equipment (in this case maritime radar). The ability to repeat tests is important in this application. The final application helps to illustrate the training capability of the proposed concept, in this case for an ESM equipment.

6.3.1 Application 4: Naval radar field-testing

Overview: The main issue was being able to evaluate the performance of this naval radar with targets that could be controlled and tests repeated. The cost of doing this live would be prohibitive for each test and repeating tests in an identical way would be near impossible.

Objective: to generate synthetic targets in S-band for over-air transmission on a land based site. A horn antenna would be placed around 1 km from the radar's antenna. The test shell would have access to the transmission pre-pulse and emit signals emanating from synthetic (hostile) targets that were varying in range but on a fixed bearing relative to the radar being tested.

Test Shell Involvement: planning took place for The RTDC to produce a number of scenarios that involved air targets approaching the platform from a fixed direction. The test shell scenarios would support the need for targets to be located on a bearing that was fixed, due to the physical constraint of using a fixed transmitting horn antenna.

The test shell would use the current waveform of the real transmitter and generate returns synchronised to the transmissions of the radar being tested. The transmission times would be compensated for the 1 km separation of the horn antenna and the radar being tested by adding an (approximately) 3 μ sec delay to the return signals. Although this was not a critical feature because the absolute range with time was not significant for

processing purposes. Supplier 4 would provide the site, the horn antenna and a suitable power amplifier, plus manpower to operate the equipment. The RTDC would be funded to provide the test shell and scenarios and be available during the testing period.

Unfortunately, the radar company were affected by the economic situation and needed to reduce the numbers of staff. This had a double effect, fewer people would be available to provide the facilities and employing The RTDC as a sub contractor at a time of redundancy would not be commercially acceptable.

Contribution: this work illustrated that the concept is viable, as perceived by a commercial organisation, for purposes of live testing. It will be appreciated that commercial organisations require a consensus of opinions that include a technical assessment by subject matter experts. These assessments are not trivial. There are consequences for their organisation, as well as for the individuals, if a flawed assessment is undertaken. Hence, if the technical outcome was not likely to be that promised, the time and effort spent to achieve the above would not have been committed. If a fatal flaw had been encountered the technical assessment would have been terminated. That it was not terminated is evidence that no such flaw was found. This is expanded in the related endorsement document provided by the subject matter expert heading the assessment.

6.3.2 Application 5: Type approval testing

Overview: Commercial marine radar equipment has recently become subject to quantitative measurement before type approval is issued. This is discussed in section G.1.1 (page 293). British Standard (BS EN 62388:2008) [100] defines the tests and the performance that is required. Currently, there are two methods of marine radar testing in Europe. One is over-water from a land-based fixed site, one of which is in the UK and run by QinetiQ at Shoeburyness. The other is on a ship based in Hamburg that sails four times per year carrying several manufacturers' equipments for testing. This is supplemented by shore-based facilities. Other capabilities include fixed laboratory testing. One of these facilities is exploring the use of this concept to add a dynamic quality and provide the means to meet the new regulations.

Objective: the objective is to provide a completely synthetic environment for performing the tests defined in the standard. A secondary requirement is to provide synthetic targets to complement real-world returns from a new shore-based site.

Test Shell Involvement: The tests specified in the standard have been programmed as scenarios in this test shell. Insertion of synthetic targets into a live environment would be as described for application 4. The platform and targets each have pre-defined routes, speeds, turns as defined in the standard. The parameters of the radar being tested are entered and the returns are applied to the receiver of the radar being tested. The bridge display system is driven by the receiver in the normal way and it is monitored for the features defined in the specification. This includes collision alarm sounding, a feature that is not practical to test in a live environment.

Maritime vessels used for commercial purposes are equipped with an Automatic Identification System (AIS) that transmits the vessels details on a regular basis. The information includes the name of the vessel, its course

and positional coordinates. It is intended to add this feature to synthetic targets in the test shell.

Contribution: This work is on going and has the interest of not only the test facility, Supplier 5, but also maritime radar manufacturers. The application reinforces the real-time over-air aspects of interest to application 4 but it adds the new dimension of a second sensor system being used alongside the radar. AIS support utilises the test shell feature to support data fusion applications. All other applications described here require single-sensors.

In addition to the radar simulation, for which an improved clutter algorithm is needed, it will be necessary to include AIS simulation for the synthetic vessels. This can be achieved because the test shell necessarily has the information because it is generated as part of the target's navigational features described previously. It will also be noted that the test shell has relative range and bearing information that can be compared to that of the radar being tested. In this way, the accuracy of the calculations of the radar under test can be assessed.

6.3.3 Application 6: An MoD ESM application

Overview: the existence of this MoD project is classified to Secret and so cannot be discussed in detail because that would indicate how/where it is being used. However, if necessary, a contract number can be provided and application for information made directly to the MoD. The following details are generic and are included to show that the test shell concept has been evaluated for a sensor other than the radar example described so far. The AIS application described for application 5 is being considered but it is not yet implemented, whereas the ESM sensor test shell, described here, has been implemented.

The RTDC had a contract to provide ESM equipment that was accepted using a traditional acceptance procedure. This involved laboratory (parametric) tests and a live test ('live' meaning it was subjected to a real but uncontrolled environment and its performance observed). This combination of tests is typical of traditional final testing for MoD contracts. It will be appreciated that they are less than ideal. Firstly, the parametric tests verify the parameters that were defined but are 'static' in their nature. Secondly, the dynamic live testing is intended to bridge the gaps. However, the uncontrolled nature of the environment means that the tests are dependant upon the limited data; this may or may not be adequate. Furthermore, the quality of their assessment is dependant upon the skill of the tester's familiarity with the local RF environment. Tests often take the form of searching for known features from the local environment.

Objective: A test shell was modified to produce ESM signals as an adjunct to the traditional acceptance procedure. The scenarios were controllable and repeatable. This enabled comparative testing to be performed and the 'live' testing could be extended into areas where infrequently occurring events could easily be introduced. It was intended to gain subjective feedback about the suitability of the concept as a testing method.

Test Shell Involvement: The work described previously, in section 4.5, relates to this application. Complex RF signals were generated by the test shell, derived from RF equipment carried by the targets. The equipment being tested provided visualisation of data sources based upon their emissions. This could be compared with the ‘real-world’ situation generated by the scenario generator’s visualisation provided by the test shell. The operators who took part in the acceptance were pleased with the results compared to a ‘standard’ acceptance test. They spent several hours, after acceptance was completed, ‘playing’ with the system to explore closest point of approach and other features that produce distinct display patterns and signatures that operators can experience with real equipment when these infrequent situations occur. The DE&S group have since assisted with promoting the concept within the MoD.

Contribution: This application provides evidence that the concept applies to more than one sensor type. It also shows the value of the visualisation display compared to the traditional acceptance test. The parametric based testing needs to be performed by specialists whereas the tests conducted with the test shell can be understood by a wider stakeholder group.

The uncontrolled environment can also involve operators, but definitive identification of features is a hit-and-miss situation that, at best is transient. The test shell approach allowed the specialists and the operators to communicate enthusiastically. They re-ran some scenarios to see the transient effects that are difficult to observe in the uncontrolled environment.

This suggests that there is a training application for the test shell. The visualisation aspect provided benefit in this case, compared to the uncontrolled environment where targets could not be observed alongside the ESM display.

6.4 Summary of Visualisation Proposal

The use of Google Earth showing the position of the sensor platform and targets was understood by all. However, the reaction to it differed between stakeholders. Scenarios ranged from moderately complex to quite simple concerning inclusion of target representation and clutter for example.

Technical specialists: their reaction was that it added very little, they could visualise the situation perfectly well without it. However, some personnel found it useful when one of their more senior colleagues used it to explain a feature. This was experienced on applications 2, 3 and 5.

Project managers: the reaction of project managers was one of casual interest. Predictably, their main questions were of the nature of ‘is that what we said it would do?’ They engaged with the display and colleagues to discuss subtleties of range detection, false targets due to artefacts and other issues. This was experienced on applications 2, 3 and 6.

Business development managers: as a group, these were the most enthusiastic. They were involved in 3 of the applications and in each case suggested that this would be a useful selling aid. In two cases, the company is considering adopting the proposed approach for this purpose. This was experienced on application 5.

DE&S personnel: The concept was discussed with other DE&S personnel in addition to those involved with these applications. Their approach was positive but it was not overwhelmingly so. On many projects they have seen the ‘serious computer games’ displays where the presentation and quality are close to TV images. They are unfamiliar with the use of the proposed visual techniques to monitor technical progress during a project (because this proposed approach is novel in this respect). Their normal approach is to rely on a progress meeting and undertake a guided walk-around of new developments. In the case of any concerns, they would engage with Dstl (for example) but were cautious about distracting the prime contractor with

unscheduled questions or activities. Asked if they felt their current approach was adequate their response was 'probably not'.

Summary: based upon the technical assessments that were undertaken by subject matter experts, there were no outright negative reactions and the average is favourable. As it stands, the visualisation approach is estimated by the author to be adding value. It has demonstrably been used in these applications to stimulate discussion in a way that has not been seen by this author when written specifications are used instead. That was its intended function.

There is some evidence to support joining this approach with that of serious games to improve the visualisation aspects. Work is being initiated to fund some of this work under the auspices of the Synthetic Environment Tower of Excellence's program.

6.5 Summary of Test Shell Proposal

The architecture of the test shell has been able to support the applications explored so far. The modular structure has been shown to support algorithms to be modified to meet specialised needs. These needs, expressed in the language of test shell development, rely upon the architecture using massively parallel processing. This introduces issues of optimisation of processing capability that includes trade-off situations between processing and look-up capability. The type of storage and structure of the data stored are critical factors at the data rates required for the types of high-speed applications considered here. Expressed in terms of a radar specialist, changes to target fidelity and adding complex sequences of EXIs in territory that has many different clutter types would be a good way forward. This would support increased in-depth evaluation of complex scenarios.

It has been found optimal to form teams of specialists, comprising people with the appropriate mix of skills, to identify these issues. This is cooperative way of working has been shown to meet objectives that the individual specialists cannot meet on their own. There is opportunity for academia to contribute to this way of working. This offers the potential to

broaden the approach by introducing new sensor related concepts as well as improved algorithms for the various aspects that require them. It is consistent with, and an example of, the government's intent to strengthen the supply chain.

6.6 Summary of T&E Implementation Proposal

The proposal to devolve T&E to be an SME activity, using equipment such as the test shell has not been fully evaluated. Variants of it, for the different parts of the lifecycle, have been explored in applications 1 and 4 but not to a great extent. It is hoped that further work in this area, fostered and supported the interest shown at senior levels of the MoD (as described in section 4.1), will allow more progress to be made in this direction.

7 Summary, Conclusions, Further Work

This section concludes this research thesis. The work is summarised and conclusions drawn. There is, however, more work that needs to be done and these areas are presented here.

7.1 Summary

The MoD's procurement organisation (DE&S) and their procurement practices were investigated (Chapter 2). DE&S performance is measured in terms of delivering on time and to budget with all DLODs available when required. The development of the procurement system has been tumultuous in terms of change and re-organisations in attempts to meet performance objectives. Section 2.1 and Appendix A are devoted to unravelling the history so that this research may be better informed and avoid some of the historic issues. These issues and the key findings of 4 recent major reports, (Gray, SDSR, Levene and Luff - Appendix B) are summarised in Table 1 – Organisational Issues Relevant to this Research. Associated with the table is a first-pass at the significance of these findings to this research (section 2.1.3). The research aims to address the shortfalls and avoid the pitfalls, as related to T&E.

The practices used by DE&S, plus their outcomes involved an analysis of the process itself – section 2.2 and Appendix C and performance analysis – by results published by the NAO – section 2.3 and Appendix D. Comparisons between projects, and of a single project over a period, are difficult because accounting procedures vary in both dimensions. Some useful findings were established, sections 2.3.2 to 2.3.3. However, interviews with DE&S personnel, current and past as well as Serving Officers (section 2.4) revealed a number of issues that were confirmed by the Gray report. The phrase 'Enterprise change' arose in this context. Levene and Gray are carrying out a major Enterprise change. A proposed additional aspect of this was developed by this research. It is finding guarded favour

with Capability and Senior Serving personnel. Work to develop this further is continuing.

These issues are summarised in Table 8, as they relate to this research. This table also has associated with it some pointers about how the information informed this research (section 2.4.2).

The findings from these two tables were used to formulate 6 questions in an attempt to evaluate the potential for continuing the research (section 2.7). The assessment criteria were those set out in the introduction, where sponsoring company's objectives and those of the MoD in this area were stated.

It was found that there is a good chance of meeting both objectives and the research continued by evaluating 8 areas of current practice

1. Procurement Options
2. DE&S Guidance
3. Systems Engineering
4. Specifying & Measuring Radar Performance
5. Visualisation and Simulation Software
6. Technically Based Software Tools
7. Testing Techniques
8. When to Test

The best-of-breed techniques from each of these were identified and used to structure the research. The outcome is a technical solution, a generic T&E test shell plus devolving the T&E activity from the (prime) contractor with a contract to deliver equipment. The T&E test shell is not a pre-requisite for the devolution of the T&E capability. The T&E test-shell is likely to be required for sensor related systems.

The government's intent to increase the share of work to SME organisations to 25 % by value provided the path to making the commercial construct implemented by the SME sector. This option also addresses issues such as

the possibility of prime contractor intellectual property right (IPR) infringements. An SME organisation is not as well placed to benefit from such infringements, as a larger company would be.

The technical solution is one that several technical specialists have challenged, based upon practicality of implementation (section 4.2). The research went to some lengths to demonstrate that appropriately applied modern technology makes the solution feasible. A T&E test shell prototype has been developed, with much appreciated help from radar and ESM specialists.

The test shell is designed to support other sensor types but this was not done during this research period. However, the way this work can be extended is developed in this thesis (e.g. sections 4.6, 4.9.2.4 and 4.13). Section 6 shows that the proposed T&E test shell can find application throughout each stage of the CADMID lifecycle, as it was designed to do.

7.2 Conclusions

The research addressed the question:

“Is there a way to improve the specification and monitoring of sensor procurement programs, such that there is one set of criteria from concept stage to delivery that can be used for all stages of development, that is independent of any particular program or supplier, with the aim of reducing risk and cost whilst offering support for future sensor fusion applications?”

A generic (not project specific) test-shell is offered to support a wide range of sensor systems, across all phases of the CADMID cycle. A commercial construct is also offered that may be used in conjunction with the test-shell or independently of it.

Ideally, a new project would have been run with both these and the current techniques used in parallel. That is not practical. It was possible to run the test shell on different projects, each at different points in their CADMID cycle.

The test shell uses modern firmware techniques that help to overcome the challenges experienced by previous attempts to implement real-time stimulation. This research program used just one FPGA of modest size. It was shown that all of the technical issues relating to speed of operation with complex algorithms could be overcome. Latency issues could also be overcome by using the appropriate method of interfacing with the unit being tested. In some cases this is at PC level (position information is an example), in other cases it requires direct FPGA interfacing (synchronising with a real-radar’s time of emission is an example). The visual interface, using Google Earth in this case, was found by users with an operational and managerial background to add value. It allowed better communication with the technical stakeholders. This was summarised in section 6.4.

Not all of the radar technical capabilities that were evaluated are described in this thesis, due to lack of space. Foliage penetration and diffraction due to atmospheric conditions are examples. Issues arising from the comments presented in section 4.2 have been addressed and overcome during the research period. In summary, where sensor specific issues have been identified, the test-shell approach and implementation method has allowed the path to their solution to be shown to be possible and practical – including finding a suitable solution to the cost issues. The test shell configuration, as proposed and implemented, is a fraction of the cost of the theatre-style demonstrators and the bespoke solutions that have are available. Furthermore, this solution is small and portable, it uses COTS components and it is not project specific – all advantages compared to the previous work in this area. The generic nature of the test-shell means that its production and operation can be independent of a contractor whose deliverable equipment is being tested. This is a significant contribution to independence of evaluation and good-practice as identified by INCOSE and others.

Further work to assess the test-shell with other sensor types is required before the final assessment can be made. However, based on radar and ESM sensors, it has been demonstrated that significant results can be achieved.

This research has presented a new way to consider specification, measurement and training relating to complex sensor systems.

The commercial construct, devolving T&E to an SME organisation, did not achieve the level of testing that was anticipated. However, the principle has been shown to be acceptable to DE&S by its consideration for use on a project. It is unfortunate that the project was subsequently cancelled. Some senior Military and Capability personnel have expressed enthusiasm for introducing ways to provide independent assessment of the status of projects placed with prime contractors. The proposed method offers a way that such assessment is part of the normal operation of a project, not something that would increase cost and cause friction if a detailed status

report is deemed necessary. The approach proposed here is still being considered in this regard.

It is frustrating that timescales in defence applications are long and the pace slow. However, this is inevitable given the size and diversity of the MoD's organisation.

The research objectives and scope outlined in Chapter 1 are very significant in terms of their effects upon the MoD's procurement of sensor systems. It will contribute to the aims of reducing risk and cost as well as timescales. The objectives of re-use, more use of COTS equipment and less bespoke design are met within the scope of test and evaluation. The work presented here supports the claims made. The commercial construct for delivering T&E by SME participants also addresses government objectives. The recent reports and White Papers indicate that the government's thinking would be supported by this research. The situation within DE&S is in some turmoil until its future is resolved. This research is of significant interest to sensor systems stakeholders and will continue to contribute to the debate about the way that test and evaluation is carried out in the future.

7.3 Further Work

This thesis describes the extent of the research undertaken so far. It recognises that further work is required, particularly in the following areas:

Addition of other sensors to improve coverage of data fusion applications as described in section 4.9.2.4. The process adopted for radar and ESM sensors (section 4.13) needs to be applied as new sensors are added. An initial cursory look at the implementation issues suggests that the complexity of implementation is not significantly greater for other sensors. The FPGA basis of implementation, supported by PC software is likely to be adequate.

Clutter is of major concern to radar systems and more work is needed to improve performance of the test shell in this area. In particular, no definitive work has been found that unambiguously relates clutter parameters to measurable weather and environmental conditions – described in section 5.5. The simplified Weibull distribution used in the research does not reflect the state-of-the-art in sea clutter representation. It would be desirable to involve clutter subject matter experts in finding a way to implement the more advanced algorithms that are available.

User-friendly improvements The test shell would benefit from further development to make it more user-friendly. In particular, the addition of a suitable data entry system for setting-up scenarios would be useful as described in sections 4.8 and 5.12. Microsoft Excel was used to create data tables to define scenarios, transmitted waveform I-Q values, target reflecting point positions in space and other parameters. The concept of a ‘parameter wall’ used in the implementation means that there is a clear interface between algorithmic access by the PC and FPGA processing and the setting of parameters. Parameters could be changed dynamically by having a user interface writing to the parameter wall during execution of a scenario. An example would be a pilot ‘flying’ an aircraft sensor platform through the scenario playing area as the scenario develops. Work to provide a DIS/HLA interface to support this is being considered with a simulation specialist.

This will be a first-step in utilising much more powerful visualisation tools than provided by Google Earth.

Direct RF input to a phased array is likely to be an area of future interest, given the popularity of these antennas. More work is required to optimise the approach for this as described in section 5.3. It is possible that an array of the type being tested could be used to drive signals into the array on the equipment being tested. This technique can give rise to some problems being masked due to the commonality. Independent separate testing is the traditional way to identify the possibility of such a situation.

Lessons Learned The research identified that no systematic method of applying lessons learned from previous projects to current ones is in-place, other than by the memory of stakeholders (section 2.5). The scenario structure proposed by this research lends itself to improving this situation. For example, there is the option to document the discrepancy identified in earlier equipment as part of the scenarios' data sets to be used for all future equipment of a similar type.

An enterprise modification was proposed in section 4.1. This requires further work with all stakeholders to find solutions to the implementation issues that can be expected to arise by its adoption. All stakeholders will be able to identify pros and cons from their perspectives. It is necessary that these are fully addressed so that any future method of working offers each stakeholder an advantage with minimal disadvantages. The method need to be accepted by all for it to be effective.

More field-testing of the test shell would be beneficial so that any remaining issues can be resolved and an improved process developed for using the test shell. The process should include operating procedures, training, MoD recruitment issues etc. It is intended that the technical implementation has a structure that can be populated to meet the needs of specific tests. Some tests require more fidelity in certain areas than others do. Once a high fidelity implementation for each aspect is introduced, it may be more cost-effective to adopt it for all tests so that its performance is

consistent. Developing a lower fidelity model may save FPGA resources, for example, but this needs to be balanced against the cost of the alternative and its general acceptance based upon the incidence of its use.

Distributed Operation. The test shell can be used in multiple locations by synchronising the start of a scenario, clock interval updates and results obtained at each location. There is a network infrastructure to support network operation based upon DIS/HLA architecture (see section 3.3.1). Furthermore, many applications use 'serious games' for visualisation purposes (see section 3.5). The proposed test shell would support distributed operation that uses this existing infrastructure. In this way distributed testing for example of a Defensive Aids Suite that uses radar, LIDAR, ESM and acoustic sensors could be tested at the sites of the manufacturers of each system component before being assembled in one location for final integration and test. Similarly, distributed training system with hardware in the loop can be considered so that the forces train with the actual equipment they use operationally.

References & Bibliography

The following list includes all references, books, other documents and internet sites that were reviewed during this research. The order is that of their occurrence in this document.

- [1] MoD, Defence Technology Strategy for the 21st Century (DTS) *DTS White Paper* MoD London.Oct.2006.
http://www.mod.uk/NR/rdonlyres/27787990-42BD-4883-95C0-B48BB72BC982/0/dts_complete.pdf
- [2] Defense Under Secretary, DoD High Level Architecture (HLA) for Simulations USD (A&T) Washington D.C.Sept.1996.
- [3] MoD, The Defence Industrial Strategy (DIS) *Defence White Paper CM6697* HMSO London.Dec.2005.
http://www.mod.uk/nr/rdonlyres/f530ed6c-f80c-4f24-8438-0b587cc4bf4d/0/def_industrial_strategy_wp_cm6697.pdf
- [4] "Defence Personnel Totals" *Defence Management* R & F Defence Publications Shrewsbury UK 2009
<http://www.armedforces.co.uk/mod/listings/10013.html>
- [5] "MoD 'is top heavy with civil servants'" *Defence Management* R & F Defence Publications Shrewsbury UK 29-9-2009
http://www.defencemanagement.com/news_story.asp?id=10773
- [6] Hines, N., "William Hague risks Europe row with referendum call" *The Sunday Times* 8-10-2009.
- [7] B. Gray, Review of Acquisition for the Secretary of State for Defence MoD London.Oct.2009.
<http://www.mod.uk/NR/rdonlyres/78821960-14A0-429E-A90A-FA2A8C292C84/0/ReviewAcquisitionGrayreport.pdf>
- [8] Watts, S., Griffiths, H. D., Holloway, J. R., Kinghorn, A. M., Money, D. G., Price, D. J., Whitehead, A. M., Moore, A. R., Wood, M. A., and Bannister, D. J., "The Specification and Measurement of Radar Performance" *IEE RADAR 2002* Edinburgh International Conference Centre Radar 2002 Proceedings 15-17 Oct.2002 pages 542 - 546. IEE.London. 15-10-2002.
- [9] Ward, Keith D., Tough, Robert J. A., and Watts, S Ch Title: "The Specification and Measurement of Radar Performance" Book Title: *Sea Clutter: Scattering, the K Distribution and Radar Performance* The IET pages 311 - 335. Series: IET Radar, Sonar, Navigation and Avionics Series 20 Series Editors: Stewart, N. and Griffiths, H. D. ISBN 0 86341 503 2 2006.

- [10] Watts, S., Griffiths, H. D., Holloway, J. R., Kinghorn, A. M., Money, D. G., Price, D. J., Whitehead, A. M., Moore, A. R., Wood, M. A., and Bannister, D. J., "The Specification and Measurement of Radar Performance" *IEE RADAR 2002* Edinburgh International Conference Centre Radar 2002 Proceedings 15-17 Oct.2002 pages 542 - 546. IEE.London. 15-10-2002.
- [11] P. Luff and J. Brokenshire, National Security Through Technology: Technology, Equipment, and Support for UK Defence and Security *White paper CM8278* MoD London.Feb.2012.
<http://www.mod.uk/NR/rdonlyres/4EA96021-0B99-43C0-B65E-CDF3A9EEF2E9/0/cm8278.pdf>
- [12] P. Luff and J. Brokenshire, National Security Through Technology: Technology, Equipment, and Support for UK Defence and Security *White paper CM8278* MoD London.Feb.2012.
<http://www.mod.uk/NR/rdonlyres/4EA96021-0B99-43C0-B65E-CDF3A9EEF2E9/0/cm8278.pdf>
- [13] National Audit Office, The Major Projects Report 2010 The Stationery Office Belfast.Oct.2010.
- [14] B. Gray, Review of Acquisition for the Secretary of State for Defence MoD London.Oct.2009.
<http://www.mod.uk/NR/rdonlyres/78821960-14A0-429E-A90A-FA2A8C292C84/0/ReviewAcquisitionGrayreport.pdf>
- [15] MoD, "Securing Britain in an Age of Uncertainty: The Strategic Defence and Security Review" . 19-Oct.-2010.
- [16] P. L. Levene, "Defence Reform: An independent report into the structure and management of the Ministry of Defence" ID P002437128 06/11. 27-June-2011.
- [17] P. Luff and J. Brokenshire, National Security Through Technology: Technology, Equipment, and Support for UK Defence and Security *White paper CM8278* MoD London.Feb.2012.
<http://www.mod.uk/NR/rdonlyres/4EA96021-0B99-43C0-B65E-CDF3A9EEF2E9/0/cm8278.pdf>
- [18] B. Gray, Review of Acquisition for the Secretary of State for Defence MoD London.Oct.2009.
<http://www.mod.uk/NR/rdonlyres/78821960-14A0-429E-A90A-FA2A8C292C84/0/ReviewAcquisitionGrayreport.pdf>
- [19] B. Gray, Review of Acquisition for the Secretary of State for Defence MoD London.Oct.2009.
<http://www.mod.uk/NR/rdonlyres/78821960-14A0-429E-A90A-FA2A8C292C84/0/ReviewAcquisitionGrayreport.pdf>

- [20] B. Gray, Review of Acquisition for the Secretary of State for Defence MoD London.Oct.2009.
<http://www.mod.uk/NR/rdonlyres/78821960-14A0-429E-A90A-FA2A8C292C84/0/ReviewAcquisitionGrayreport.pdf>
- [21] B. Gray, Review of Acquisition for the Secretary of State for Defence MoD London.Oct.2009.
<http://www.mod.uk/NR/rdonlyres/78821960-14A0-429E-A90A-FA2A8C292C84/0/ReviewAcquisitionGrayreport.pdf>
- [22] MoD, "Securing Britain in an Age of Uncertainty: The Strategic Defence and Security Review" . 19-Oct.-2010.
- [23] P. L. Levene, "Defence Reform: An independent report into the structure and management of the Ministry of Defence" ID P002437128 06/11. 27-June-2011.
- [24] P. L. Levene, "Defence Reform: An independent report into the structure and management of the Ministry of Defence" ID P002437128 06/11. 27-June-2011.
- [25] P. L. Levene, "Defence Reform: An independent report into the structure and management of the Ministry of Defence" ID P002437128 06/11. 27-June-2011.
- [26] P. L. Levene, "Defence Reform: An independent report into the structure and management of the Ministry of Defence" ID P002437128 06/11. 27-June-2011.
- [27] Sec of State, Equipment, Support, and Technology for UK Defence and Security *A Consultation Paper CM7989* MoD London.Dec.2010.
- [28] P. Luff and J. Brokenshire, National Security Through Technology: Technology, Equipment, and Support for UK Defence and Security *White paper CM8278* MoD London.Feb.2012.
<http://www.mod.uk/NR/rdonlyres/4EA96021-0B99-43C0-B65E-CDF3A9EEF2E9/0/cm8278.pdf>
- [29] P. Luff, Equipment, Support, and Technology for UK Defence and Security *A Consultation Paper CM 8277* MoD London.Feb.2012.
http://www.mod.uk/NR/rdonlyres/F4ACE80C-BFD7-463D-99A6-2B46098BB0C4/0/cm7989_Eqpt_supp_tech_ukdef.pdf
- [30] P. Luff and J. Brokenshire, National Security Through Technology: Technology, Equipment, and Support for UK Defence and Security *White paper CM8278* MoD London.Feb.2012.
<http://www.mod.uk/NR/rdonlyres/4EA96021-0B99-43C0-B65E-CDF3A9EEF2E9/0/cm8278.pdf>

- [31] B. Gray, Review of Acquisition for the Secretary of State for Defence MoD London.Oct.2009.
<http://www.mod.uk/NR/rdonlyres/78821960-14A0-429E-A90A-FA2A8C292C84/0/ReviewAcquisitionGrayreport.pdf>
- [32] Crown, MODAF Architectural Framework Overview *MODAF-M09-002* HMSO.Aug.2005.
- [33] National Audit Office, The Major Projects Report 2010 The Stationery Office Belfast.Oct.2010.
- [34] National Audit Office, The Major Projects Report 2010 The Stationery Office Belfast.Oct.2010.
- [35] B. Gray, Review of Acquisition for the Secretary of State for Defence MoD London.Oct.2009.
<http://www.mod.uk/NR/rdonlyres/78821960-14A0-429E-A90A-FA2A8C292C84/0/ReviewAcquisitionGrayreport.pdf>
- [36] National Audit Office, The Major Projects Report 2010 The Stationery Office Belfast.Oct.2010.
- [37] B. Gray, Review of Acquisition for the Secretary of State for Defence MoD London.Oct.2009.
<http://www.mod.uk/NR/rdonlyres/78821960-14A0-429E-A90A-FA2A8C292C84/0/ReviewAcquisitionGrayreport.pdf>
- [38] National Audit Office, The Major Projects Report 2010 The Stationery Office Belfast.Oct.2010.
- [39] National Audit Office, The Major Projects Report 2010 The Stationery Office Belfast.Oct.2010.
- [40] National Audit Office, A summary of the NAO's work on the Ministry of Defence 2010-11 National Audit Office.Sept.2011.
http://www.nao.org.uk/publications/1012/departamental_overview_mod.aspx
- [41] B. Gray, Review of Acquisition for the Secretary of State for Defence MoD London.Oct.2009.
<http://www.mod.uk/NR/rdonlyres/78821960-14A0-429E-A90A-FA2A8C292C84/0/ReviewAcquisitionGrayreport.pdf>
- [42] National Audit Office, The Major Projects Report 2010 The Stationery Office Belfast.Oct.2010.
- [43] Mathieu, Larive, "Winning the War by Winning the Peace: Strategy for Conflict and Post-Conflict in the 21st Century" *Annual Strategy Conference*.Carlisle Barracks, Pennsylvania. 13-4-2004.

- [44] Levy, A., "War in Yugoslavia: Nato's media blunders" *Reporters sans frontieres* 5, rue Geoffroy Marie; 75 009 Paris 1999.
- [45] Standardisation of PFI Contracts *PU101* HM Treasury.Mar.2007.
http://www.hm-treasury.gov.uk/d/pfi_sopc4pu101_210307.pdf
- [46] "Technical Support – The Framework Agreement for Technical Support (FATS)" *UK MoD Acquisition Management System* UK MoD. 6-6-2007 <http://www.ams.mod.uk/content/topics/pages/3545.htm>.
- [47] MoD, "Urgent Operational Requirements (UOR)" *MoD Fact Sheet* MoD.London. 2010
<http://www.mod.uk/DefenceInternet/FactSheets/DefencePolicyandBusiness/UrgentOperationalRequirementsuor.htm>.
- [48] B. Gray, Review of Acquisition for the Secretary of State for Defence MoD London.Oct.2009.
<http://www.mod.uk/NR/rdonlyres/78821960-14A0-429E-A90A-FA2A8C292C84/0/ReviewAcquisitionGrayreport.pdf>
- [49] AMS MoD, "Acquisition Operating Framework (AOF)" *Acquisition Operating Framework (AOF) website*. 1-10-2006
http://www.aof.mod.uk/aofcontent/tactical/ppm/content/lifecycles/cadmids.htm?zoom_highlight=CADMID.
- [50] DSTAN MoD, "Principles of Defence Acquisition (PDA) ver 01 Jan 2003" *DSTAN MoD*. 2003 <http://www.dstan.mod.uk/pda.ppt>.
- [51] Requirements and Acceptance Evolution - CADMID Guidance to DE&S *AOF Website*.Nov.2011.
<https://www.aof.mod.uk/aofcontent/tactical/randa/content/randaevolution.htm>
- [52] DE&S, "AOF - Integrated Test, Evaluation and Analysis Plan (ITEAP)" *MOD AOF website* MoD. 2011.
- [53] Watts, S., Griffiths, H. D., Holloway, J. R., Kinghorn, A. M., Money, D. G., Price, D. J., Whitehead, A. M., Moore, A. R., Wood, M. A., and Bannister, D. J., "The Specification and Measurement of Radar Performance" *IEE RADAR 2002* Edinburgh International Conference Centre Radar 2002 Proceedings 15-17 Oct.2002 pages 542 - 546. IEE.London. 15-10-2002.
- [54] Lutz, Robert John Hopkins University, "FEDEP V1.4: An Update to the HLA Process Model" *Winter Simulation Conference 1999*. Institute for Operational research and the Management Sciences.Winter Simulation Conference. 1999.
- [55] Ford, Keith Thales, "The Euclid RTP 11.13 Synthetic Environment Development & Exploitation Process" *Simulation Interoperability*

- Conference*. Simulation Interoperability Standards Organization (SISO). 2001.
- [56] Defense Under Secretary, DoD High Level Architecture (HLA) for Simulations USD (A&T) Washington D.C.Sept.1996.
- [57] Link, Nora, "ISRTA in Synthetic Environment - CAE" *ISRSC (SAR/SLAR) 2004* Ottawa.Ottawa. 14-9-2004.
- [58] Lutz, Robert John Hopkins University, "FEDEP V1.4: An Update to the HLA Process Model" *Winter Simulation Conference 1999*. Institute for Operational research and the Management Sciences.Winter Simulation Conference. 1999.
- [59] Ford, Keith Thales, "The Euclid RTP 11.13 Synthetic Environment Development & Exploitation Process" *Simulation Interoperability Conference*. Simulation Interoperability Standards Organization (SISO). 2001.
- [60] Ford, Keith Thales, "The Euclid RTP 11.13 Synthetic Environment Development & Exploitation Process" *Simulation Interoperability Conference*. Simulation Interoperability Standards Organization (SISO). 2001.
- [61] M. Brasse, O. M. Mevassvik, and Skoglund Tom, Federation Composition Process and Tool Support in EUCLID RTP 11.13 TNO (Netherlands) & FFI (Norwegian Defence Organisation).2000.
http://www.tno.nl/defensie_en_veiligheid/commandovoering_en_operat/simulatoren/euclid_rtp_11_13/03F-SIW-047.pdf
- [62] "NITEWorks.Net - ENIF" *Crown copyright website*. 2004
<http://www.naodefencevmf.org/downloads/pdf/NITEworks.pdf>.
- [63] "NITEWorks.net" *Crown copyright website*. 2004
<http://www.niteworks.net/>.
- [64] NITEWorks, "QuickLooks - a new Niteworks delivery option - A guide for MoS Staff" *Niteworks* Niteworks Farnborough UK. 22-9-2009
<http://www.niteworks.net/news/>.
- [65] Crown, MODAF Architectural Framework Overview *MODAF-M09-002* HMSO.Aug.2005.
- [66] Couretas, J. M. "System Architectures: Legacy Tools/Methods, DoDAF Descriptions and Design Through System Alternative Enumeration" *The Journal of Defense Modeling and Simulation: Applications, Methodology, Technology* 3 4 pages 227 .- 237 1-10-2006
<http://dms.sagepub.com/content/3/4/227.abstract>

- [67] Watts, S., Griffiths, H. D., Holloway, J. R., Kinghorn, A. M., Money, D. G., Price, D. J., Whitehead, A. M., Moore, A. R., Wood, M. A., and Bannister, D. J., "The Specification and Measurement of Radar Performance" *IEE RADAR 2002* Edinburgh International Conference Centre Radar 2002 Proceedings 15-17 Oct.2002 pages 542 - 546. IEE.London. 15-10-2002.
- [68] Ward, K. D., Tough, R. J. A, and Watts, S. "*Sea Clutter: Scattering, the K Distribution and Radar Performance*" IET Series: IET Radar, Sonar, Navigation and Avionics Series 20 Series Editor: Stewart, N. and Griffiths, H. D. ISBN 0 86341 503 2 2006
- [69] Gruppung, J., "Flight Simulator History" *website*. 2012
<http://fshistory.simflight.com/>.
- [70] MoD, The Defence Industrial Strategy (DIS) *Defence White Paper CM6697* HMSO London.Dec.2005.
http://www.mod.uk/nr/rdonlyres/f530ed6c-f80c-4f24-8438-0b587cc4bf4d/0/def_industrial_strategy_wp_cm6697.pdf
- [71] MoD, Defence Technology Strategy for the 21st Century (DTS) *DTS White Paper* MoD London.Oct.2006.
http://www.mod.uk/NR/rdonlyres/27787990-42BD-4883-95C0-B48BB72BC982/0/dts_complete.pdf
- [72] "VBS2" Bohemia Interactive Simulations Florida USA 2012
<http://armory.bisimulations.com/products/vbs2/overview>
- [73] Black, R. "*Managing the Testing Process: Practical Tools and Techniques for Managing Hardware and Software Testing*" Ed. 3 Wiley ISBN 10: 0-470-40415-9 1-8-0009
- [74] D. Murray and M. Dumble, SimTE Initial Study – Final Report - SIF *SL01M000SR1 issue 3* Cap JTES/ SE Tower of Excellence.Jan.2012.
- [75] Forsberg, K. and Mooz, H., "Application of the "VEE" to Incremental and Evolutionary Development" Proceedings of the National Council for System Engineering (INCOSE) Conference.St Louis MO. 1995.
- [76] Boehm, Barry W. "A Spiral Model of Software Development and Enhancement" *Computer* page 60 - 72 1988
- [77] Cloutier, Robert "*Systems Engineering Handbook*" Ed. 3.1 2nd printing INCOSE ISBN INCOSE-TP-2003-002-03.1 2008
- [78] Verzuh, E "*The Portable MBA in Project Management*" John Wiley & Sons Inc. ISBN 0-471-26899-2 2003

- [79] Loo, R. "Working Towards Best Practices in Project Management: a Canadian Study" *International Journal of Project Management* 20 Pergamon Canada page 93 - 98 2002
- [80] P. Luff and J. Brokenshire, National Security Through Technology: Technology, Equipment, and Support for UK Defence and Security *White paper CM8278* MoD London.Feb.2012.
<http://www.mod.uk/NR/rdonlyres/4EA96021-0B99-43C0-B65E-CDF3A9EEF2E9/0/cm8278.pdf>
- [81] B. Gray, Review of Acquisition for the Secretary of State for Defence MoD London.Oct.2009.
<http://www.mod.uk/NR/rdonlyres/78821960-14A0-429E-A90A-FA2A8C292C84/0/ReviewAcquisitionGrayreport.pdf>
- [82] P. Luff and J. Brokenshire, National Security Through Technology: Technology, Equipment, and Support for UK Defence and Security *White paper CM8278* MoD London.Feb.2012.
<http://www.mod.uk/NR/rdonlyres/4EA96021-0B99-43C0-B65E-CDF3A9EEF2E9/0/cm8278.pdf>
- [83] P. A. Foster, Policy For The Coordination Of Military Electromagnetic Spectrum Allocations And Assignments Between Cooperating Nations *ACP 194* The Combined Communications-Electronics Board (CCEB).June2011.
<http://jcs.dtic.mil/j6/cceb/acps/acp194/ACP194.pdf>
- [84] "Radio frequency spectrum" . 07-Sept.-2006.
- [85] Dawber, W. "*Study to establish measurement parameters for testing radar bandsharing performance*" Ed. QINETIQ/EMEA/TS/CR0705949/1.1 QinetiQ Ltd 1-10-2007
- [86] "Object Management Group (OMG)" <[12] Volume>. <[05] Date, primary>. Web: <http://www.omg.org>
Date accessed: <[28] Date, secondary>
- [87] Williams, Ed., "Aviation Formulary V1.44" *website*. 2009
<http://williams.best.vwh.net/avform.htm>.
- [88] "*WGS 84 Implementation Manual*" Ed. V4 EUROCONTROL European Organization for the Safety of Air Navigation Brussels,Belgium 12-2-1998
- [89] Digital Terrain Elevation Data (DTED) National Geospatial-Intelligence Agency Denver, CO USA.May2000.
<https://www1.nga.mil/ProductsServices/Pages/PublicProducts.aspx>
- [90] Andrews, Larry C. "*Field Guide to Atmospheric Optics*" Ed. 1 SPIE Press Series: Field Guides Series Editor: Greivenkamp, John. E. ISBN 0-8194-5318-8 2004

- [91] Payne, C "Principles of Naval Weapon Systems" Ed. 1 Naval Institute Press ISBN 13: 978-1-59114-658-2 2006
- [92] Mil Std 1553 US Dept of Defense Washington USA.1973.
<http://www.milstd1553.com/>
- [93] IEEE 802.3-2008 IEEE Standards Association.2008.
<http://standards.ieee.org/about/get/802/802.3.html>
- [94] "PCIe Specification" PCI Sig Beaverton Oregon USA 18-11-0010
<http://www.pcisig.com/specifications/pciexpress/base3/>.
- [95] S. Venuti, HDMI Graphics Interface HDMI Licensing, LLC Sunnyvale CA USA.2009.
http://www.hdmi.org/manufacturer/hdmi_1_4/index.aspx
- [96] DVI .Apr.1999.
http://www.ddwg.org/lib/dvi_10.pdf
- [97] Billingsley, J. B. "Low-Angle Radar Land Clutter: Measurements and Empirical Models" IET London UK ISBN 0-85296-230-4 1-5-2002
- [98] Report on the investigation of the loss of the sailing yacht Ouzo and her three crew South of the Isle of Wight during the night of 20/21 August 2006 Marine Accident Investigation Branch, Southampton.Apr.2007.
http://www.maib.gov.uk/cms_resources.cfm?file=/Ouzo_.pdf
- [99] Stimson, George W. Ch Title: "Radar Fundamentals" Book Title: *Introduction to Airborne Radar* Ed. 2 SciTech Publishing Inc pages 123 - 123 ISBN 1-891121-01-4 1998.
- [100] "Maritime navigation and radio communication equipment and systems. Shipborne radar. Performance requirements, methods of testing and required test results" Vol. BS EN 62388:2008 British Standards Institute 30-5-2008
- [101] Murray, M. T. "Some Aspects of Operational Analysis in the Ministry of Defence" *The Journal of the Operational Research Society* 38 10 Palgrave Macmillan Journals pages 875 .- 882 1-10-1987
<http://www.jstor.org/stable/2582647>
- [102] "History of the MoD" website. 5-4-2012
<http://www.mod.uk/DefenceInternet/AboutDefence/History/HistoryOfTheMOD/>.
- [103] Murray, M. T. "Some Aspects of Operational Analysis in the Ministry of Defence" *The Journal of the Operational Research Society* 38 10 Palgrave Macmillan Journals pages 875 .- 882 1-10-1987
<http://www.jstor.org/stable/2582647>

- [104] Lindop, A. J. Dr, "Cost Effectiveness in UK Defence Procurement: The COEIA" *AGARD CONFERENCE PROCEEDINGS 602 - Strategic Management of the Cost Problem of Future Weapon Systems* NATO Advisory Group for Aerospace Research and Development (AGARD) pages 15-1. NATO.Norway. 22-9-1997.
- [105] Lang, J. D. et al, "The Value of Science & Technology in Affordability" *AGARD CONFERENCE PROCEEDINGS 602 - Strategic Management of the Cost Problem of Future Weapon Systems* NATO Advisory Group for Aerospace Research and Development (AGARD) pages 20-1 - 20-17. NATO.Norway. 22-9-1997.
- [106] Lang, J. D. et al, "The Value of Science & Technology in Affordability" *AGARD CONFERENCE PROCEEDINGS 602 - Strategic Management of the Cost Problem of Future Weapon Systems* NATO Advisory Group for Aerospace Research and Development (AGARD) pages 20-1 - 20-17. NATO.Norway. 22-9-1997.
- [107] "History of the MoD" *website*. 5-4-2012
<http://www.mod.uk/DefenceInternet/AboutDefence/History/HistoryOfTheMOD/>.
- [108] Crown, "Stategic Defence Review - White Paper: Modern Forces for the Modern World" Command Paper 3999 p. ch 8 SMART Procurement. 09-July-1998.
- [109] National Audit Office, Implementation of Integrated Project Teams *HC 671 Session 2001-2002*.Mar.2002.
- [110] Crown "The Acquisition Handbook Ed 6" Ed. 6 MoD Acquisition Management System (AMS) London UK 1-10-2005
- [111] BBC, "Warning over MoD kit overspend"
http://news.bbc.co.uk/1/hi/uk_politics/3421309.stm BBC. 23-1-2004
http://news.bbc.co.uk/1/hi/uk_politics/3421309.stm.
- [112] MoD, The Defence Industrial Strategy (DIS) *Defence White Paper CM6697* HMSO London.Dec.2005.
http://www.mod.uk/nr/rdonlyres/f530ed6c-f80c-4f24-8438-0b587cc4bf4d/0/def_industrial_strategy_wp_cm6697.pdf
- [113] MoD, Defence Technology Strategy for the 21st Century (DTS) *DTS White Paper* MoD London.Oct.2006.
http://www.mod.uk/NR/rdonlyres/27787990-42BD-4883-95C0-B48BB72BC982/0/dts_complete.pdf
- [114] NAO, MoD Major Projects Report 2005 *HC 595* The Stationery Office London.Nov.2005.
http://www.nao.org.uk/publications/0506/major_projects_report_2005.aspx

- [115] B. Gray, Review of Acquisition for the Secretary of State for Defence MoD London.Oct.2009.
<http://www.mod.uk/NR/rdonlyres/78821960-14A0-429E-A90A-FA2A8C292C84/0/ReviewAcquisitionGrayreport.pdf>
- [116] B. Gray, Review of Acquisition for the Secretary of State for Defence MoD London.Oct.2009.
<http://www.mod.uk/NR/rdonlyres/78821960-14A0-429E-A90A-FA2A8C292C84/0/ReviewAcquisitionGrayreport.pdf>
- [117] B. Gray, Review of Acquisition for the Secretary of State for Defence MoD London.Oct.2009.
<http://www.mod.uk/NR/rdonlyres/78821960-14A0-429E-A90A-FA2A8C292C84/0/ReviewAcquisitionGrayreport.pdf>
- [118] MoD, "Securing Britain in an Age of Uncertainty: The Strategic Defence and Security Review" . 19-Oct.-2010.
- [119] MoD, "Securing Britain in an Age of Uncertainty: The Strategic Defence and Security Review" . 19-Oct.-2010.
- [120] MoD, "Securing Britain in an Age of Uncertainty: The Strategic Defence and Security Review" . 19-Oct.-2010.
- [121] P. L. Levene, "Defence Reform: An independent report into the structure and management of the Ministry of Defence" ID P002437128 06/11. 27-June-2011.
- [122] P. L. Levene, "Defence Reform: An independent report into the structure and management of the Ministry of Defence" ID P002437128 06/11. 27-June-2011.
- [123] P. L. Levene, "Defence Reform: An independent report into the structure and management of the Ministry of Defence" ID P002437128 06/11. 27-June-2011.
- [124] P. L. Levene, "Defence Reform: An independent report into the structure and management of the Ministry of Defence" ID P002437128 06/11. 27-June-2011.
- [125] P. Luff and J. Brokenshire, National Security Through Technology: Technology, Equipment, and Support for UK Defence and Security *White paper CM8278* MoD London.Feb.2012.
<http://www.mod.uk/NR/rdonlyres/4EA96021-0B99-43C0-B65E-CDF3A9EEF2E9/0/cm8278.pdf>
- [126] P. Luff, Equipment, Support, and Technology for UK Defence and Security *A Consulation Paper CM 8277* MoD London.Feb.2012.
http://www.mod.uk/NR/rdonlyres/F4ACE80C-BFD7-463D-99A6-2B46098BB0C4/0/cm7989_Eqpt_supp_tech_ukdef.pdf

- [127] P. Luff and J. Brokenshire, National Security Through Technology: Technology, Equipment, and Support for UK Defence and Security *White paper* CM8278 MoD London.Feb.2012.
<http://www.mod.uk/NR/rdonlyres/4EA96021-0B99-43C0-B65E-CDF3A9EEF2E9/0/cm8278.pdf>
- [128] P. Luff and J. Brokenshire, National Security Through Technology: Technology, Equipment, and Support for UK Defence and Security *White paper* CM8278 MoD London.Feb.2012.
<http://www.mod.uk/NR/rdonlyres/4EA96021-0B99-43C0-B65E-CDF3A9EEF2E9/0/cm8278.pdf>
- [129] P. Luff and J. Brokenshire, National Security Through Technology: Technology, Equipment, and Support for UK Defence and Security *White paper* CM8278 MoD London.Feb.2012.
<http://www.mod.uk/NR/rdonlyres/4EA96021-0B99-43C0-B65E-CDF3A9EEF2E9/0/cm8278.pdf>
- [130] P. Luff and J. Brokenshire, National Security Through Technology: Technology, Equipment, and Support for UK Defence and Security *White paper* CM8278 MoD London.Feb.2012.
<http://www.mod.uk/NR/rdonlyres/4EA96021-0B99-43C0-B65E-CDF3A9EEF2E9/0/cm8278.pdf>
- [131] MoD, "Securing Britain in an Age of Uncertainty: The Strategic Defence and Security Review" . 19-Oct.-2010.
- [132] B. Gray, Review of Acquisition for the Secretary of State for Defence MoD London.Oct.2009.
<http://www.mod.uk/NR/rdonlyres/78821960-14A0-429E-A90A-FA2A8C292C84/0/ReviewAcquisitionGrayreport.pdf>
- [133] National Audit Office, The Major Projects Report 2010 The Stationery Office Belfast.Oct.2010.
- [134] B. Gray, Review of Acquisition for the Secretary of State for Defence MoD London.Oct.2009.
<http://www.mod.uk/NR/rdonlyres/78821960-14A0-429E-A90A-FA2A8C292C84/0/ReviewAcquisitionGrayreport.pdf>
- [135] National Audit Office, The Major Projects Report 2010 The Stationery Office Belfast.Oct.2010.
- [136] B. Gray, Review of Acquisition for the Secretary of State for Defence MoD London.Oct.2009.
<http://www.mod.uk/NR/rdonlyres/78821960-14A0-429E-A90A-FA2A8C292C84/0/ReviewAcquisitionGrayreport.pdf>
- [137] National Audit Office, The Major Projects Report 2010 The Stationery Office Belfast.Oct.2010.

- [138] National Audit Office, The Major Projects Report 2010 The Stationery Office Belfast.Oct.2010.
- [139] National Audit Office, The Major Projects Report 2010 The Stationery Office Belfast.Oct.2010.
- [140] Kirkpatrick, D. Prof "The Cost of Delay" *RUSI Defence Systems* June 2010 page 28 - 31 1-6-2010
- [141] B. Gray, Review of Acquisition for the Secretary of State for Defence MoD London.Oct.2009.
<http://www.mod.uk/NR/rdonlyres/78821960-14A0-429E-A90A-FA2A8C292C84/0/ReviewAcquisitionGrayreport.pdf>
- [142] National Audit Office, The Major Projects Report 2010 The Stationery Office Belfast.Oct.2010.
- [143] MoD PFI Contracts 2009 .Oct.2009.
<http://www.thinkdefence.co.uk/2009/10/the-mods-pfi-list/>
- [144] Review of PFI Projects in Construction and Operation *Final* MoD PFU.Dec.2005.
http://www.mod.uk/NR/rdonlyres/AB2251DB-7E36-42AA-872C-1F663828366E/0/pfu_op_review_051205.pdf
- [145] Review of PFI Projects in Construction and Operation *Final* MoD PFU.Dec.2005.
http://www.mod.uk/NR/rdonlyres/AB2251DB-7E36-42AA-872C-1F663828366E/0/pfu_op_review_051205.pdf
- [146] National Audit Office, I The Stationery Office.Mar.2007.
<http://www.nao.org.uk//idoc.ashx?docId=809d9a1b-7598-457e-9280-076a838eceb3&am>
- [147] Pollock, A., "Uncovering the true costs of PFI" *The Guardian* 23-9-2009.
- [148] BBC, Government to 'prop up' PFI deals BBC.Mar.2009.
http://news.bbc.co.uk/1/hi/uk_politics/7920522.stm
- [149] ARM, Ltd, CoWare, Synopsis, and CynApps "System C" 1999
<http://www.arm.com/about/newsroom/352.php>
- [150] "GEDAE" Gedae, Inc. 1247 N Church Street, Suite 5 Moorestown, NJ 08057. 2005.
- [151] Razdow, A. "MathCad" Adept Scientific 1986
<http://www.mathcadshop.co.uk/estore.html?gclid=CPG61tS-kaUCFVEA4wod4X7DNA>

- [152] "MATLAB & Simulink" The MathWorks.3 Apple Hill Drive Natick, MA 01760-2098 Phone: 508-647-7000 Fax: 508-647-7001. 01-Jan.-2006.
- [153] "MATLAB & Simulink" The MathWorks.3 Apple Hill Drive Natick, MA 01760-2098 Phone: 508-647-7000 Fax: 508-647-7001. 01-Jan.-2006.
- [154] "VisSim" Visual Solutions Inc. 1989
<http://www.vissim.com/>
- [155] "xUML" Kennedy Carter 2008
<http://cplus.about.com/od/glossar1/g/xmldefn.htm>
- [156] Aegis Technologies "HLA Tools" Aegis Technologies 2007
http://www.aegistg.com/Training_Implementing_HLA_13.htm
- [157] Calytrix "SIMplicity" Calytrix Technologies Inc 2006
<http://www.calytrix.com/news/newsitem/86/>
- [158] Pratt, D. R Dr and Franceshini, R. W. Dr "Test & Training Enabling Architecture TENA" Science Applications International Corporation (SAIC) 2006
<https://www.tena-sda.org/display/intro/Home>
- [159] Andro "Electromagnetic Environmental Effects (E3) Expert" Andro Computational Solutions LLC 2010
http://www.androcs.com/html/e3_expert.html
- [160] Bird, D "FACETS" Thales Wells Somerset Thales Land & Joint Systems, UK Wookey Hole Road Wells Somerset BA5 1AA. T: +44 (0) 1749 672 081 2006
- [161] Vincent, Ross and Denis, Dion, "Marine environment background synthesis using MODTRAN 4" pages 62390H. SPIE. 12-4-2006.
- [162] Pugh, M. L. and Zulch, P. A. "RL-STAP" Rome Labs USA 1995
<http://www.computer.org/portal/web/csdl/doi/10.1109/ACSSC.1995.540885>
- [163] "SAIC Radsim" SAIC SAIC Corporate Headquarters, 10260 Campus Point Drive, San Diego, CA 92121 phone 1-800-430-7629 2005
www.saic.com/products/simulation/radsim3/
- [164] Russell.R "Virtio" Open Source Internet Linux 2007
<http://portal.acm.org/citation.cfm?id=1400097.1400108>
- [165] Summit Design "Vista" Summit Design Inc 2006
<http://www.design-reuse.com/news/12697/summit-design-vista-ide-simplifies-intellectual-property-development-design-sharing-systemc-designs-without-run-time-license.html>

- [166] "Sensor Modelling Language (SML)" VisAnalysis Systems Technologies (VAST) - a group in University of Alabama 2004
http://portal.opengeospatial.org/files/?artifact_id=11516
- [167] "*Maritime navigation and radio communication equipment and systems. Shipborne radar. Performance requirements, methods of testing and required test results*" Vol. BS EN 62388:2008 British Standards Institute 30-5-2008
- [168] Sampson - Next Generation Multi-function Radar BAE SYSTEMS Frimley UK.2011.
http://www.baesystems.com/cs/groups/public/documents/document/mdaw/mdm4/~edisp/baes_021431.pdf
- [169] "AWACS Surveillance Radar - The Eyes of The Eagle" Northrop Grumman Corporation.USA. 2012.
- [170] Watts, S. and Gordon, A. J., "The Searchwater family of airborne radars" *Radar 97 (Conf. Publ. No. 449)* Radar 97 (Conf.Publ.No.449) pages 334 - 338. 14-10-1997.
- [171] EuroRadar, "Captor Radar" Selex-Galileo. 2012.
- [172] Stevens, M. "*Secondary Surveillance Radar*" ISBN 0890062927 1-3-1998
- [173] M. E. Weber, The Next Generation Multi-Mission U.S. Surveillance Radar Network Lincoln Laboratory & MIT USA.Feb.2007.
- [174] Lacomme.P, Hardange.J, Marchais.J, and Normant.E Ch Title: "Radar Equation in Free Space" Book Title: *Air and Spaceborne Radar Systems, An introduction* IET ISBN 0-85296-981-3 1999.
- [175] "*Electronic Warfare and Radar System Engineering Handbook*" Ed. Rev 2 Naval Air Systems Command and Naval Air Warfare Center USA 1-4-1999
- [176] McCandless, S. W. and Jackson, C. R. "*SAR Users Manual*" Ed. 1 U.S. Department of Commerce National Oceanic and Atmospheric Administration (NOAA) 1-9-2004

Appendix A The Procurement Process History

This appendix to section 2.1 presents a short history of the key changes to the procurement organisation of the MoD. Its purpose is to illustrate the number of changes that have occurred that have led to the current atmosphere and personnel attitudes to the prospects of further change.

This research is aimed at assisting in breaking out of this process by considering the lifecycle of project as a single commercial-technological entity rather than procurement of a technological entity.

A.1.1 First World War to 2006

During the First World War, the Defence Chiefs had control of procurement and that situation was re-instated in 2011. However, the intervening period saw exponential growth in technology and so the evolution is more complex than a simple cyclic one. Attempts were made during the intervening years to harness the technological growth rate and this led to a ballooning of the MoD's establishment. Statistics and a perceptive quotation are presented in section 1.1.2.

The situation enjoyed by the Service Chiefs was challenged by Lloyd George in 1930 when the civilian role of Minister for Coordination of Defence was created. During the Second World War Winston Churchill took over this role, such was its importance. Clement Attlee reinstated the role after the war but the Chiefs agreed what was required to meet their objectives. In 1971, the Procurement Executive was formed and it was just that, an executive body to handle the mechanics of procurement. Technological growth was beginning to be recognisable by this time and The Defence Operational Analysis Establishment (DOAE) was set up as described by an article in the Journal of the Operational Research Society in October 1987 [101]. By 1991, the DOAE had spawned the Air, Land and Sea Warfare Centres to deal with introduction of technology to the respective Services. The Defence Research Agency (DRA) existed to consider the future

applications of emerging technologies. Consolidation started around 1995 (see section A.2) when several establishments were merged to form a 9,000 strong Defence Establishment Research Agency (DERA) in support of, but separated from, the 7,000 strong Procurement Executive.

By 2009, there was economic pressure, due to the world banking crisis that started to emerge in 2007; there was also a change of UK Government in 2010. It was being recognised that the procurement policy was stretched; the value of orders placed was greater than the budget to pay for them. This led to stop-go procurement that itself added to the cost as analysed in section 2.3.

A.1.2 The Analysis Role

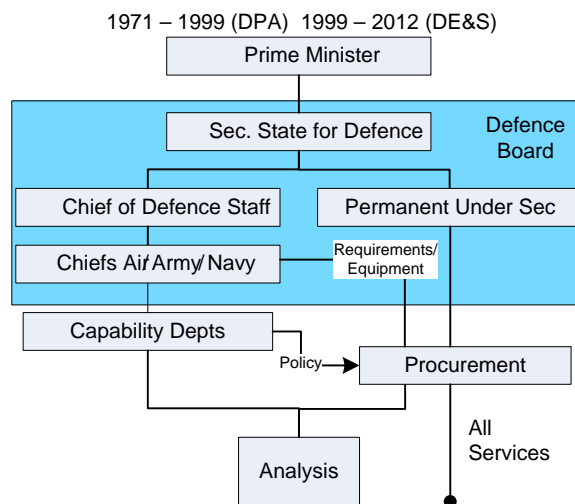

Figure 44 – Procurement 1971 - 2012

The History of the MoD [102] tells us that “In 1971 the Government called on Mr Derek Rayner to advise on its relations with the aviation industry. One of his principal recommendations was the transfer to the MOD of the military aviation task, to be undertaken by a separate organisation within the MOD. In 1971 the Admiralty, the War Office, Air Ministry, Ministry of Aviation and an early MoD were formed into an MoD that we would recognise today. The Procurement Executive was born on 2 August 1971, with Mr (later Lord) Rayner as its first Chief Executive.”

This more professional approach mandated that specifications need to be analysed scientifically, contracts needed to be drawn-up in a way appropriate to the contract type. No longer could the Chiefs of Staff directly control what they needed, an intermediate layer was added and the generation of specifications was entrusted to specialists. The Defence Operational Analysis Establishment (DOAE) was set up as described by an article in the Journal of the Operational Research Society in October 1987 [103]. After 1971, once the analysis had been performed, the Procurement Executive of MoD (MoD(PE)) would place orders with industry.

This structure, analysis informing procurement, would set the standard for several iterations of change that followed and would hold for 40 years as shown in Figure 44. A 'Head Office' group in Whitehall communicated with the Chiefs of Staff, answered questions and passed concepts for evaluation to the DOAE in West Byfleet; Northwood; Brampton and units assigned mainly to the RAF and RN. 200 analysts, plus a £4M extramural group then wrote code, originally in FORTRAN, to provide stochastic simulations to answer questions such as detection probability and 'success' rate by using Monte Carlo simulations.

These techniques would be largely incomprehensible to Chiefs of Staff and Whitehall people, even if they could have communicated directly with those undertaking the work rather than their Head Office representatives. The scientific approach was to be trusted, not least because it was new, scientific and somewhat obscure to most – few would be brave enough to challenge the 'scientific evidence' and risk their promotion chances.

A.1.3 Scientific Methodology

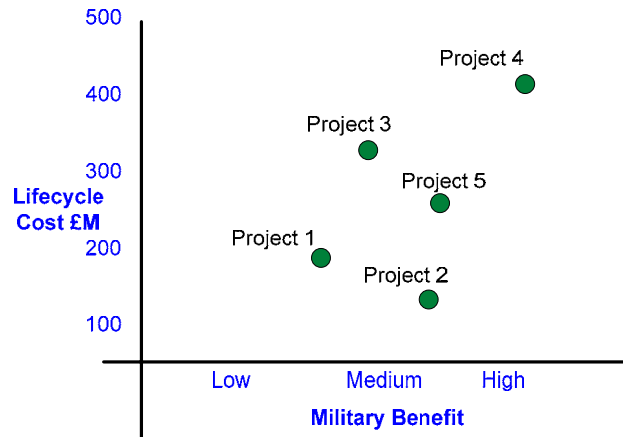

Figure 45 – Military Equipment Cost-Benefit Analysis

There was always an awareness of value for money that continues today. To help build business cases, the DOAE sought a method of comparison of alternative technical approaches. Ideally, MoD Whitehall needed a traditional business case to put to the Treasury with costs, financial benefits and measures such as return on investment. They were not sure how to measure financial benefits of military equipment. The Combined Operational Effectiveness and Investment Appraisal (COEIA) approach evolved around 1993. This is described by Dr A.J. Lindop, from the then recently formed centre of procurement excellence at MoD Abbey Wood, at the 1997 AGARD²⁹ Conference [104]. For each option, lifecycle costs on the y-axis of a 2-D graph were matched with military effectiveness (low-high etc) on the x-axis – thereby avoiding assigning an actual cost to the benefits whilst providing a method of comparing expected benefits and costs between options. The concept is shown in Figure 45.

They also recognised the timescale issue and a COEIA would be run 2-3 times during a lifecycle. This method was a good solution but must have been open to subjective criticism according to the political and financial arguments about perceived military advantage. This manifestation of inter-Service rivalry still exists in Whitehall. For example, today there is still the

²⁹ AGARD - Advisory Group for Aerospace Research and Development a NATO group to disseminate information of interest to its members.

debate about ‘does the Navy need Trident or would many more conventional weapons spread across the 3 Services, be more pragmatic in meeting today’s actual threat?’

Each Service competes for Treasury money. It should be clearly stated that, although there may be inter-Service rivalry in Whitehall, the Services cooperate very well in the field.

A.2 Consolidation

The DOAE, later Defence Operational Analysis Centre, spawned the Air, Land and Naval Warfare centres. In 1991, the Defence Research Agency (DRA³⁰) was formed, to pool resources, from:

1. The Royal Aerospace Establishment (RAE Farnborough)
2. The Admiralty Research Establishment (ARE Portland Dorset and Portsmouth Hampshire)
3. The Royal Armament Research and Development Establishment (RARDE Fort Halstead)
4. The Royal Signals and Radar Establishment (RSRE Malvern)

In 1995, the following groups were also amalgamated with DRA to form the Defence Evaluation and Research Agency (DERA) History³¹:

5. The Defence Test and Evaluation Organisation (DTEO – various trials ranges)
6. The Chemical and Biological Defence Establishment (CBDA Porton Down)
7. The Centre for Defence Analysis (CDA)

DERA grew to 9,000 people, taking over much of the early stage analysis work, backed by the Warfare Centres’ specialists, and MoD(PE) employed around another 7,000 at its inception in 1991. Validation of the models and simulations generated were by departmental colleagues, the only people who

³⁰ A useful description of DRA is given at <http://www.cs.ucl.ac.uk/research/renoir/members/dra.html>

³¹ The context and demise of DERA is explained at the following National Archive website <http://webarchive.nationalarchives.gov.uk/+http://www.mod.uk/DefenceInternet/FactSheets/ModAndQinetiq.htm>

could understand the techniques. There is a potential discontinuity of understanding between the two groups of stakeholders, military and scientific. The communications links were tenuous and it took a significant time to produce results. Not all agencies were wholly in favour of this approach, J.D Lang of Boeing said in his paper 'The Value of Science & Technology in Affordability' at a NATO Advisory Group for Aerospace Research and Development (AGARD) conference in 1997 [105]:

'Science and Technology (S&T) programs can have critical impact on the cost of aeronautical systems. The problem is to teach S&T personnel how to deal with the impact that their technologies have on cost as well as they deal with the technical performance impacts.' [106]

Analysis responsibility changed from DERA to the Defence Science and Technology Laboratory Dstl. This separated the classified defence needs of the MoD from less classified MoD activities. Manning and operating test ranges were gifted to QinetiQ when the split of DERA was made in 2001. Dstl still provide the main analysis and scientific support to the MoD in areas where military sensitivity is greatest.

Another rationalisation of the MoD's procurement took place in 1995. Whitehall could not house all of these people and so it was decided to retain its 'Head Office' role and consolidate the procurement side to Abbey Wood Bristol, as the Defence Procurement Agency. Only 4 years later, the organisation was re-formed into the Defence Equipment and Support Executive (DE&S) [107] responsible for all aspects of procurement including all lifecycle stages. This amalgamated the functions that had become separated, it now reported to a Permanent Under-Secretary, a Civil Servant.

The 1998 Strategic Defence Review [108] (Titled "Modern Forces for a Modern World") resulted in the formation of civilian and military teams to administer acquisition of equipment. The purpose and function of Integrated Project Teams (IPTs) were explained in an National Audit Office Paper [109] and their name was later shortened to 'Project Teams' (PTs).

A.3 SMART to DIS/DTS

1999 to mid 2000 were years of stability in organisation. However, the period was punctuated by funding freezes, spending cuts and attempts to balance budget. The rivalry for funds and the inadequate methods of predicting costs were the primary cause for Government decisions that resulted in a 'stop-go' policy for individual projects.

This annoyed those whose budgets were cut; Press reports appeared and so the attention of voters was drawn to the situation. In 2004 the 'SMART Procurement' initiative was introduced by Lord Drayson, together with an Acquisition Handbook [110] to act as guidance for the PTs. See the inset for the 7 Principles of Smart Acquisition. The initiative carried the 'faster, cheaper, better' catchphrase to describe the objectives for procurement henceforth. It was lampooned into "faster, cheaper and riskier" by some Press, particularly following a fatal crash of a Nimrod aircraft that suffered a fuel leak whilst refuelling.

The 7 Principles of Smart Acquisition

1. a through life systems approach, typified by applying Whole Life Costing techniques
2. Integrated Project Teams (IPTs) with clearly identified customers
3. a better, more open relationship with industry
4. more investment during early project phases
5. effective trade-offs between system performance, through life costs and time
6. new procurement approaches
7. a streamlined process for project approvals

Smart procurement, like much of Labour's last 12 years, was more sound bite than substance. "Faster, cheaper and riskier" might have been more appropriate. Guardian October 30 2009³²

³² <http://www.guardian.co.uk/uk/2009/oct/30/defence-nimrod-report-fatal-errors>

A quotation from the BBC Friday, 23 January 2004, 15:28 GMT summarises the issues that faced the MoD in its dealings with its suppliers [111]:

"The Ministry of Defence is facing heavy criticism for an overspend of more than £3bn on major projects. ... Lord Bach denied there was any effort to "punish" BAE but said the arms industry in general must "raise its game". ... Sir Raymond Lygo, chief executive of the firm in the 1990s, told BBC Radio Five: "A well-known fact, whether anybody admits it or not, is you'll never get any programme through the government if you ever revealed the real cost.

"After a year you say 'I'm terribly sorry but the costs have now risen for this reason and the other reason'."

The year 2005/2006 saw the presentation of two important White Papers, the Government's Defence Industrial Strategy (DIS) [112] in late 2005 closely followed in early 2006 by the Defence Technology Strategy (DTS) [113]. These papers set out the way forward for procurement of defence materiel and the relationship that the Government wished to foster with Industry. The papers acknowledged that strategic thinking needed to be strengthened and the shrinking budgets would mean that prioritisation would be necessary. Network capability was advocated as the way to improve the information delivered to the frontline (DIS p20) as was the rapid and efficient production of the BAES Raven UAV (DIS p89). Raven evolved from a Technology Demonstrator (TDP) program, a method perceived to be a good way for the MoD and industry to explore options, as an alternative to industry producing equipment to an MoD produced specification. The White Papers made it clear that the situation of payment regardless of results is being challenged.

To place this into context, the Nimrod MRA4 aircraft was overspending by around 30% and was delayed by 80 months, Astute submarine and Type 45 Frigate were also not running to plan. National Audit Report for Major Projects 2005 figure 1 [114]

Nimrod was later scrapped in a spectacular way; it was ‘ripped apart’ behind screens³³, the event being shown on the BBC TV news. However, Astute and T45 continued successfully into Service life.

The two papers defined which defence technologies were critical to the UK’s objectives and which industries were considered to be providing ‘Sovereign capability’³⁴. The DTS emphasised what was needed in a selection of military sectors. The importance of research and development was highlighted together with the need for a strong supply chain with active academia and small-medium enterprises (SMEs). These themes were to be taken up and greatly strengthened in later in Government thinking.

³³ BBC News Item also published on their website <http://www.bbc.co.uk/news/uk-12297139>

³⁴ Sovereign capability – a capability that the Government wishes to retain in the UK, the intent being to provide UK Forces with an advantage over other nations that can not support at least change or modification of equipment

Appendix B Recent Reforms

This appendix is germane to the research. It highlights the consolidation of Government attitudes including:

- 1 The Prime Minister and his Deputy (Strategic Defence and Security Review - Appendix B.2)
- 2 The Secretary of State for Defence (Lord Levene - Appendix B.3)
- 3 Minister for Defence Equipment and Support (Peter Luff - Appendix B.4)

This situation was preceded, maybe precipitated, by the Secretary of State for Defence commissioning Bernard Gray, a strategic thinker who was not part of the establishment, to produce a report (see the next section). The report suggests ways to reform the organisation that has emerged from the historical background described in Appendix A.

This appendix identifies the work that is taking place to respond to the demand for change and better value for money. In doing so, it defines the objectives that the Government wishes to achieve and points to the direction in which they wish to travel to achieve them. It will be understood that this research must align closely with these objectives and direction if it is to be an acceptable option for consideration.

B.1 Review of Acquisition (Gray 2009)

An introduction and summary of this report is presented in section 2.1.1.1. The following paragraphs expand some of the observations and assertions in the report, particularly those with relationship to this research. It should be pointed out that the Gray report is very comprehensive in its coverage and by no means all aspects are reviewed here.

B.1.1 Cost Prediction

Each service is responsible for making the case to support its needs in competition with other services. Gray recommended that the Defence Board should comprise the Permanent Under Secretary (Chair); Chief of Defence Staff, MoD DG Finance, Vice Chief of Defence Staff, 2nd Permanent Under Secretary, and no other [115] page 33.

The MoD currently has Capability Heads to set policy for and provide advice regarding translating the needs of the Service Chiefs into equipment specifications. Departments run by the Capability Heads include serving personnel and transfer their findings to the Defence Board by a 3-star officer (Vice-Admiral or equivalent) who is Deputy Chief of Defence Staff (Capability) (DCDS(Cap)), the Defence Board being at 4-star level. Furthermore, the Capability Heads obtain estimates for equipments from DE&S who also employ serving personnel.

Gray suggests (p44) that collusion takes place between the same-service counterparts at these two levels to ensure that attractive (low-cost) estimates are provided. This has a dual benefit:

1. to their Service (Army, Navy, Air Force) by reducing the risk of proposals being blocked by other Service Chiefs, thereby maximising the chances of each Service gaining a good share of the available funds
2. to the serving personnel in the departments by avoiding them facing charges of failing to deliver their Service's proposed equipment, (fatal for future prospects)

This collusion resulting in outside agreements by alleged 'deals in the corridors' also allows DCDS(Cap) to make life easier for the board by there being less open disagreement – thereby maximising DCDS(Cap)'s promotion opportunities (p30). Gray suggests that the organisational team feeling fostered by these relationships prevents any rebels objecting to the manipulation and so it becomes 'the norm'.

This obfuscation suggests that there is opportunity for clearer communication of pros and cons in comparing equipments and for estimating the life costs – Gray addresses the second of these by proposing financial modelling; this research addresses the first by improved technical modelling.

B.1.2 Strategy

The bottom-up aggregation process makes top-down strategy approach difficult – (Executive Summary).

Specifications and costs are built by DE&S who combine cost elements of the required equipment to provide a total cost, whereas the Capability Heads are more likely to work from a top-down approach and have interest in technological capability. Service Chiefs are interested in the value of military capability. There is serious discontinuity between these stakeholders (DE&S, Capability Heads and Service Chiefs) identified in the report.

Gray asserts that the expectations of the Capability Departments are not managed by DE&S who operate in isolation (this is exacerbated by the length of the M4 that separates them). The Capability Departments have no association with costs or their management. Gray proposes that Capability Departments should have responsibility in these areas; in fact, he proposes a much tighter definition of roles and responsibilities. In addition to allocation of responsibilities, there is a need to define how these should be discharged. The first step in this direction is to find a way for all stakeholders to communicate. Gray advocates that the common denominator is finance, but that may not sit well with the Service personnel or the technical personnel, an issue addressed by this research that extends the Gray logic to broaden the concept of modelling from financial to include technical modelling.

B.1.3 Responsibilities

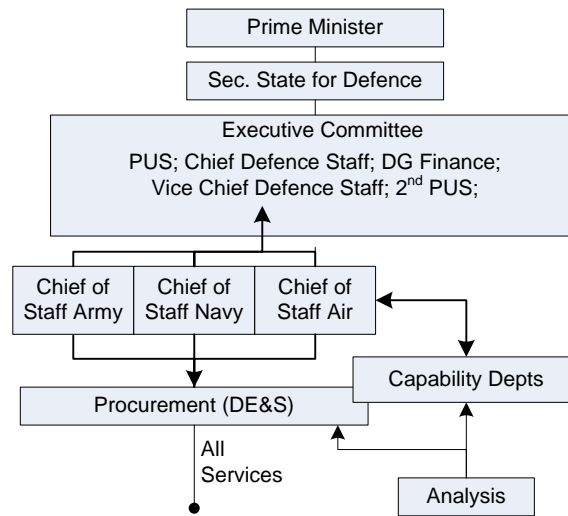

Figure 46 – Gray Proposal

Executive Committee and Responsibilities - The report is very clear about the way forward for MoD procurement. There should be an executive committee as previously described on page 264 – see Figure 46. The committee should be responsible for evaluating plans with respect to cost, benefits and alternatives. They should take a complete proposal structure from the 3-star Deputy Chief of Defence Staff (Capability) (DCDS(Cap)) and accept it or reject it. They would not be allowed to pick and mix but, if they were not satisfied, would return their concerns to the Capability Heads to re-vamp an alternative solution.

The PUS should be fully responsible for the viability of the plans adopted, similar to the chief executive of a private company (p35) and placed under duty to parliament to account for the affordability of the plan. The Director General (Finance) would have an equivalent role concerning finance; the Chief of Defence Staff would be responsible for ensuring that the plan was fit for military purpose (p32/33).

All obvious but much crisper role definitions than at present where there is a blurring of responsibilities into a collective. Similarly, Gray proposes that the DE&S 3-star structure should be rationalised and focussed upon a

financial key role. DE&S needs to divest itself of non-essential activities, such as running dockyards, and concentrate on improving its level of core skills to reduce team sizes whilst improving capability. Key engineering skills need to be added, possibly in a way similar to the French equivalent DGA organisation with whom the MoD are growing partnerships. The DGA includes technical personnel in technical roles, similar to the UK's DERA organisation of some years ago.

Gray found that there was pride in defining equipment that was 'just within the laws of physics' ([116] p23). Whilst this might meet the objective of providing a technological lead, Gray observed that an '80%' solution might be quicker and cheaper to produce and also support exportation needs of industry to boost their sales and so maintain a stronger sovereign capability. He mourned the lack of a culture that would support cyclic development, with incremental routes to improvement. An incremental approach would also achieve the same ends of faster delivery, promoting export potential and paying for what was needed not what could be achieved.

There are significant cultural barriers between the existing procurement system and what Gray believes is needed. The main one is resistance to change. Gray proposes that the answer to this is that DE&S should move to a Trading Fund status or be Government Owned but Contractor Operated (a so-called GOCO organisation). He explains his views about the efficacy of this ([117] chapter 9.5) and suggests that alternatives are considered for 12-months, if the considerations get nowhere, then the GOCO route should be taken. However the route eventually develops, there is need for an enveloping structure that engages all stakeholders – this has still to be found.

B.2 Strategic Defence and Security Review (SDSR 2010)

Fully titled: “Securing Britain in an Age of Uncertainty: The Strategic Defence and Security Review”, [118] this document sets out the Government’s Defence Strategy for the next 5 years with a less detailed view to 2020. It declares that there should be a review after 5 years compared to the Gray report’s proposal of 4 years. As its title indicates, there is a (homeland) security theme included with the defence strategy. This review considers the defence aspects and is limited to those aspects that affect this research.

The report recognises that there have been deficiencies in the support for the armed forces ([119] Foreword)

“The Royal Navy was locked into a cycle of ever smaller numbers of ever more expensive ships. We have an Army with scores of tanks in Germany but forced to face the deadly threat of improvised explosive devices in Iraq and Afghanistan in Land Rovers designed for Northern Ireland. And the Royal Air Force has been hampered in its efforts to support our forces overseas because of an ageing and unreliable strategic airlift fleet. ... We must never send our soldiers, sailors and airmen into battle without the right equipment, the right training or the right support.”

B.2.1 Armed Service Roles

The review defines roles for the armed forces based upon a rationale of the number of conflicts they might reasonably expect to support simultaneously [120] page 19. These are either:

A single long engagement with 6500 personnel plus 1 short engagement with 2000 personnel plus a ‘simple’ engagement with 1000 personnel.

Or

A long duration engagement requiring 30,000 personnel

This important statement bounds the number of scenarios that must be met. The strategy can be expanded to a series of tactical scenarios. The exploration of the capability of existing equipment and tactics in these scenarios can be used to establish likely outcomes and military effectiveness. This can lead to a full definition of any equipment deficiencies, identification of what is needed to fill the gaps and hence lead to a basis for cost estimation. The research aims to support these activities with a methodology to support traceability of decision-making.

B.2.2 Priority Objectives

The following are declared as high priority for the UK:

1. ensure that our key counter-terrorist capabilities are maintained and in some areas enhanced, while still delivering efficiency gains
2. develop a transformative programme for cyber security, which addresses threats from states, criminals and terrorists, and seizes the opportunities which cyber space provides for our future prosperity and for advancing our security interests
3. focus cross-government effort on natural hazards, including major flooding and pandemics, and on building corporate and community resilience
4. focus and integrate diplomatic, intelligence, defence and other capabilities on preventing international military crises, while retaining the ability to respond should they nevertheless materialise

The following are declared as low priority for the UK:

1. low probability but very high impact risk of a large-scale military attack by another state
2. uncertainty about longer-term risks and threats,

B.2.3 Military Tasks

The seven Military Tasks defined in the SDSR are:

1. defending the UK and its Overseas Territories
2. providing strategic intelligence
3. providing nuclear deterrence
4. supporting civil emergency organisations in times of crisis
5. defending our interests by projecting power strategically and through expeditionary interventions
6. providing a defence contribution to UK influence
7. providing security for stabilisation

It is an objective to have the capability to support the following campaigns:

1. an enduring stabilisation operation at around brigade level (up to 6,500 personnel) with maritime and air support as required, while also conducting:
2. one non-enduring complex intervention (up to 2,000 personnel), and
3. one non-enduring simple intervention (up to 1,000 personnel);

or alternatively:

- three non-enduring operations if we were not already engaged in an enduring operation;

or:

- for a limited time, and with sufficient warning, committing all our effort to a one-off intervention of up to three brigades, with maritime and air support (around 30,000, two-thirds of the force deployed to Iraq in 2003).

B.2.4 Size of each Service

| Navy | Army | Air Force |
|---|---|---|
| Trident | 5 brigades 6,500 personnel recce tanks, + support | Typhoon & JSF |
| 7 Astute submarines | Air assault brigade | 7 x C-17; 22 x A400M; 14 Airbus A330 transport/tanker |
| 1 Aircraft Carrier + 1 in extended readiness | Multiple rocket launcher 70km + loiter | 12 x Chinook |
| 6 x T45 destroyer 13x T23 frigates (T26) Merlin + Chinook | Armoured vehicle Terrier, Scout FRES Utility Vehicle | Command & control facilities |
| 1,800 Marines | Support vehicles | ISTAR: E3D Sentry; Rivet Joint Sig. Int. (Boeing RC-135V/W) |
| Wildcat & Merlin helicopters | Heavy armour Warrior; AS90 artillery; Titan; Trojan Engineering vehicles; Challenger tank | Storm Shadow Cruise Missiles (for use with fast jets) |
| 14 x mine countermeasures (Hunt & Sandown classes – replacement for hydro and patrol) | ISTAR (Watchkeeper) + Force Protection equipment | Improved simulation training |
| Survey & ice patrol | Apache, Wildcat | Protection squadron |
| Supply ships | IED disposal | CBRN capability |
| Roll-on roll-off transports | Deployable HQ + support | |
| ISTAR - various | Rapid reaction capability | |
| P32 Reduce manpower by 5,000 to 30,000 | P 32 Reduce manpower by 7,000 to 95,000 | P 32 Reduce manpower by 5,000 to 33,000 |

Table 25 – Services' Equipment Allocation

The future equipment and size of the 3 Services are defined by the report, as are the numbers of the MoD personnel needed to support them. These parameters are shown in Table 25 (derived from pages 24-27 of the SDSR). The equipments represent the initial platforms in tactical scenarios that this research aims to support.

The MoD Civil Service will also decrease by 25,000 to 60,000 by 2015 (p32). MoD spent nearly £19 billion in 2009 with UK suppliers and it has been estimated that some 300,000 UK jobs are supported by defence spending and exports. (p30) and there is the statement regarding SMEs

“We will aim to support the small and medium-sized enterprises that are a vital source of innovation and flexibility.”

There is no further explanation about how this might be achieved or who is responsible for its implementation. There are serious cuts in equipment, manpower and other services (p31) over a range of diverse areas that includes estates, personal allowances and communications. Despite these savings, this part of the report sets the size of the market and identifies that there is a role for SMEs; this research aims to establish the viability of one such role.

B.3 Defence Reform 2011 (Levene)

The Levene report's full title is "Defence Reform: An independent report into the structure and management of the Ministry of Defence" [121] June 2011. The report closely follows the Gray report's recommendations, formatting them into a structure without imposing a method of implementation.

"We have not produced a detailed blueprint....The senior leadership of Defence understands the detail better, and will be the people responsible for making it work. They must now take the lead." ([122] page 63).

The report makes it clear that there should be a 'Head Office' function to deal with strategy. The report also states that the function should be separated from the delivery functions resulting from strategic decisions. The 'Head Office' function will be covered by Whitehall with a leaner and fitter structure than previously.

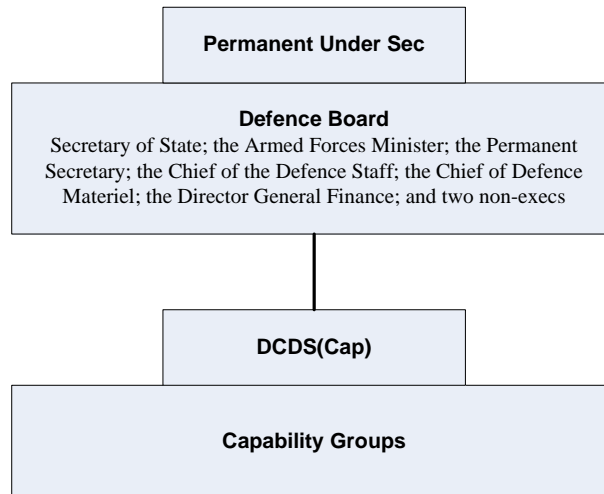

Figure 47 – Levene's Procurement Decision Making

The strategic group (Defence Board) will be headed by the Secretary of State for Defence and comprise Permanent Under Secretary (PUS); Chief of Defence Staff (CDS); Chief of Defence Materiel (CDM); Director General Finance (DG Finance); one other Minister and 3 non-executive Directors (p21) as shown in Figure 47. It will meet ten times per year, rather than on the current ad hoc basis. The PUS and CDS will share a leadership role,

representing the civilian and military staff interests. Their roles and responsibilities, like all other stakeholders, are clearly defined.

It will no longer be acceptable to operate as a committee for decision-making; committees will exist to advise and inform as necessary but decisions will be made by identified members of the Board. The CDS (and others) may consult with Chiefs of Staff (Army, Navy Air Force) in order to produce a workable strategy but their coordination will be a direct responsibility of the Defence Board, removing the need for a Commander in Chief ([123] page 35).

Those personnel not involved with strategy will be moved out of Whitehall, this includes the Defence Chiefs, and they will retain an 'office' manned by 2-star personnel for communication purposes. The strategic decisions will be handed down to each Chief of Staff, together with individual budgets for delivering their part of the strategy. The budget will cover all aspects including recruitment, training, equipment and manpower with the intent of ending the arbitration over individual equipments' trade-off between the Services. The Chiefs will each have freedom to administer their budget to meet their strategic goals, being accountable quarterly to PUS/CDS with advice from DG Finance. To assist them there will be new roles of Directors of Resources ([124] page 41).

This construct has 2 main layers, the Defence Board operates at the strategic level and the Chiefs of Staff have their own committee to discuss operational issues as well as forming advisories on strategy, equipment and any other relevant information for passing back to the Board. A functional structure is identified; the functions are shown in capital text in the following. The Board's function is to DIRECT the Chief of Staff's role is to GENERATE and DEVELOP plans and structure to deliver the strategy. The equipment and services required by the Chiefs will be delivered by DE&S (the ACQUIRE function). They will be supported in this by the ENABLERS that provide the infrastructure in terms of business techniques, buildings estates and land plus scientific advice (Defence Business Services (DBS) Defence Infrastructure Organisation (DIO) and Dstl respectively). Finally,

the OPERATE function will be provided by the Permanent Joint Headquarters (PJHQ) who will be responsible for military operations, supported by the Chiefs of staff.

The Chief of Defence Materiel (CDM) is responsible for all aspects of Acquisition. This includes appropriate administration of budgets allocated for acquisition purposes through to relationships with industry as providers to DE&S. The organisation of DE&S is under review with 3-constructs proposed by CDM (Bernard Gray) being considered by the Defence Secretary.

A summary of the reports main findings and proposals are presented at the end of section 2.1.1.3.

B.4 Security Through Technology (Luff 2011)

In December 2011 Peter Luff, Minister for Defence Equipment, Support and Technology (see Table 26) , issued a green paper (CM7989) inviting interested parties to contribute to this white paper “Security Through Technology” (CM 8278) [125]. The results of the consultation, acknowledging the scope responses (CM 8277 [126]), was issued with the white paper [127] that describes the route to be taken following this consultation.

| Defence Political Structure in Detail | |
|---|---|
| Secretary of State for Defence | Rt Hon Philip Hammond MP 19 Oct 11 Previously Liam Fox |
| Minister of State for the Armed Forces | Nick Harvey 9 Jun 10 |
| Minister for International Security Strategy | Gerald Howarth MP 27 Oct 10 |
| Personnel, Welfare and Veterans | The Rt Hon Andrew Robathan 11 Jan 11 |
| Minister for Defence Equipment, Support and Technology | Peter Luff 15 Aug 11 |
| Under Secretary of State and the Lords Spokesman on Defence | Lord Astor 28 Sep 10 |

Table 26 - Defence Political Structure

The White Paper opens with the attention grabbing observation that all of the previous proposals are 'not enough' and that a 'new approach' is needed to buying and supporting defence and security equipment from industry. The report proposes that there is potential synergy between the military and homeland security issues in current engagement with terrorist organisations, Al Qaeda for example.

The foreword to the report is provided by Peter Luff (Minister for Defence Equipment, Support and Technology – (see Table 26 for the defence political structure), and James Brokenshire, Minister for Crime and Security. Apart from potential for intelligence exchange, it is not clear how the armed services and police might cooperate. However, the report does offer support for buying commercial-off-the shelf (COTS) equipment (rather than specifically designed or 'bespoke equipment) where possible for this shared market. It sets out a decision making process so that if COTS are not suitable the next stage is to consider modified COTS and, finally, a bespoke system, but one that uses open standards. Affordability will be a consideration at all stages. It will be remembered from chapter 1 that use of COTS equipment is an objective of this research.

It is planned that there will be a funded 10-year equipment plan ([128] para 43); by comparison, yearly reviews currently take place and funding can be lost or suspended by these reviews. It is also intended that bi-lateral (for example the UK with the US or France) or multi-lateral procurement agreements, will be favoured ([129] paras 42 and 47), with the consideration of export potential being an important factor. This is intended to strengthen UK industry by providing a wider market. Science and technology budgets have reduced from 2.5% of annual defence spend to 1.2% but it is intended that it should not drop further ([130] para 43) .

In common with other government reports, this report acknowledges that academia and SMEs have a role to play. Like the Strategic Defence and Security Review (2010) [131] it is not specific about what that role might be, or who within the structure should deliver it. This research offers a way that this can take place within the framework of the current government policy.

Appendix C The Analysis Function

Analysis is provided during the CA stages of the lifecycle and is procured by the Capability Departments (Caps) or DE&S. This is referenced in section 2.2, with further explanation here. It will be noted, from the work done as part of the Gray report, that the Caps are physically disconnected from DE&S, and intellectually disconnected from implementation costs and risks. They are “proud to ask for deliveries that are 'just within the laws of physics'” - Gray report [132] p23. The outcome is a way to ensure that UK Forces are provided with leading-edge equipment, but the downside is the associated risk of making it operational in the time required for delivery. The Analysis function is offered by several organisations including Dstl and Industry including Towers of Excellence and Niteworks.

C.1 Towers of Excellence

These voluntary organisations are formed from Industry and Academia with Dstl participation. There are Towers of Excellence pertaining to Radar, Synthetic Environments and Electronic Warfare, as well as other specialist topics. They are, from time to time, invited to undertake studies or pilot projects associated with a military need. The sponsors are usually a Capability Department or Dstl. Typical values of contracts are around £1-£5M and, depending upon the rules of each Tower, the membership forms a Special Interest Group (SIG) to respond to each request. Tower opportunities have reduced since their inception; many of the Towers exist in name only. The SE Tower is an exception and a study was recently undertaken into the use of simulation techniques for test and evaluation funded by the Capability Department for Joint Training Evaluation Systems (Cap JTES). This is discussed further in section 2.4 on page 54.

C.2 Niteworks

Niteworks, an industry-based organisation that offers studies into defence issues, is described in more detail in section 3.3.4. It is funded by Cap JTES

to a level of £6M per year. This funding pays for a small permanent administrative staff that forms part of the BAE SYSTEMS organisation. In addition to the basic funding, Niteworks charge for each study that is undertaken. Niteworks members are invited to participate, based on their relevant experience, and selection is by competitive interview. Funding for members, which comprise large and small organisations as well as Academia, is in the region of a few £10K's for, typically under 6-months involvement. A typical investigation team will comprise 4-5 people.

The larger Niteworks projects, in recent years these have become rare, involve military commanders of, for example, infantry and mobile units each operating in isolated booths. Each has a display representing the computer screens or real-world view that they would experience in real-life. They communicate using simulations of their various communication methods, computers, radios etc. A scenario develops and they each respond as they would normally. This is a training aid but also a way to evaluate new techniques. Niteworks does not support significant inclusion of real equipment.

Appendix D Major Projects' Analysis

The 2010 report [133] was used to identify the cost overrun and time overrun on those major projects for which complete data sets were presented. The estimated and currently predicted costs are shown in Figure 48 and Figure 49 where the projects are organised by overspend, from low to high (-ve indicates under-spend).

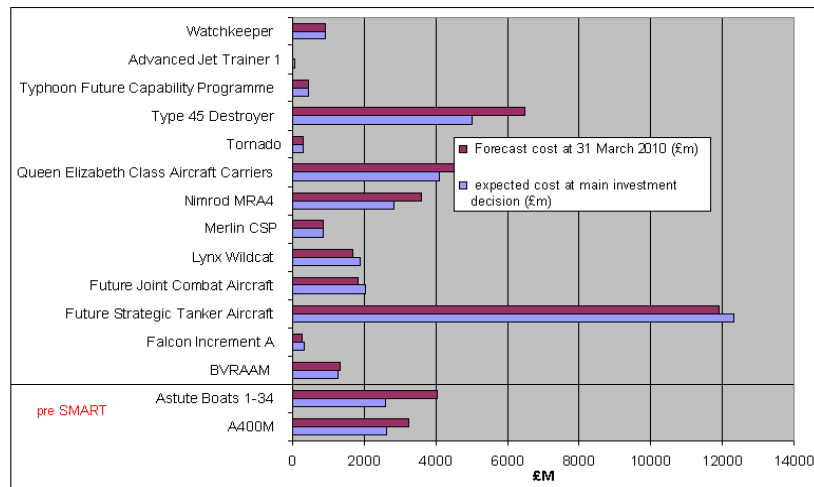

Figure 48 – Project Spend Analysis

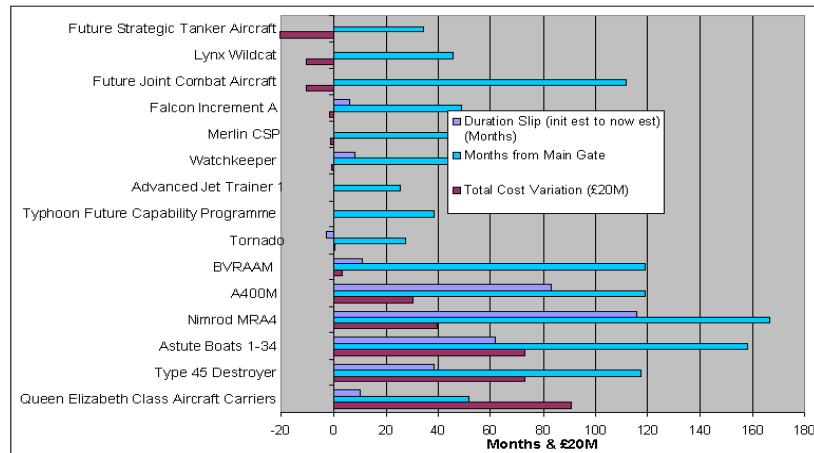

Figure 49 – Project Cost, Delivery Time and Project Time

The pre-SMART (see section A.3 for a description of SMART Acquisition) sample size is too small to allow comparison of performance pre and post the introduction of SMART Acquisition. A comparison of the performance reported in the Gray report vs. the performance in 2010 suggest that SMART Acquisition has created an improvement – see Table 27.

| Issue | Gray | 2010 |
|-----------------------|-------------|------------------------|
| Average Time Overruns | 80% (5yrs) | 0 (max nearly 3 years) |
| Average Overspend | 40% (£300M) | 4% (£151M) |

Table 27 -- Changes in Performance since the Gray Report

The underlying statistics that existed in 2009, at the time of the Gray report [134], were significantly worse than is revealed by the 2010 figures [135]. Unfortunately, this improvement was not sustained in 2011 figures.

D.1 Project Time and Delay analysis.

Correlation between the time from Main-Gate (contract award) and expected delay is about 80% as is shown in Figure 50. A straight line and 2nd order best-fit line have been added to the graph (using the least-squares method) and the equations are shown in the figure. The sample size is small and there are no detailed projects starting within 21 months. No specific conclusion, can be draw from the time into a project that the slips are declared, other than they are post Main-Gate i.e. in the 'DM' stages of CADMID and, as time progresses, the expected delay increases. The significance of this point becomes clearer with the procurement process analysis in section 3.2.1.

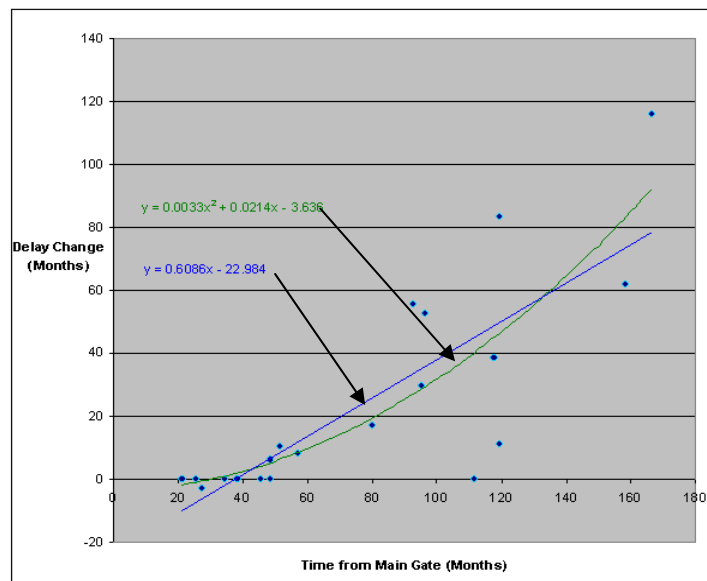

Figure 50 – Project Time vs. Delivery Delay

D.2 Technical Performance

Cost and delivery parameters are important issues that address the ‘failing to produce’ part of the charge that “the system is failing to produce the equipment we don’t need” (The Gray Report [136] (p8)). The ‘equipment we don’t need’ part is accounted for by the fact that needs have moved-on since the equipment was defined. Alternatively, this arises because some DLODS are missing, making the equipment unusable. Technical performance against Defence Lines of Development (DLODs – see Table 3) and Key Performance Measures can be examined – see Figure 51 and Figure 52 respectively.

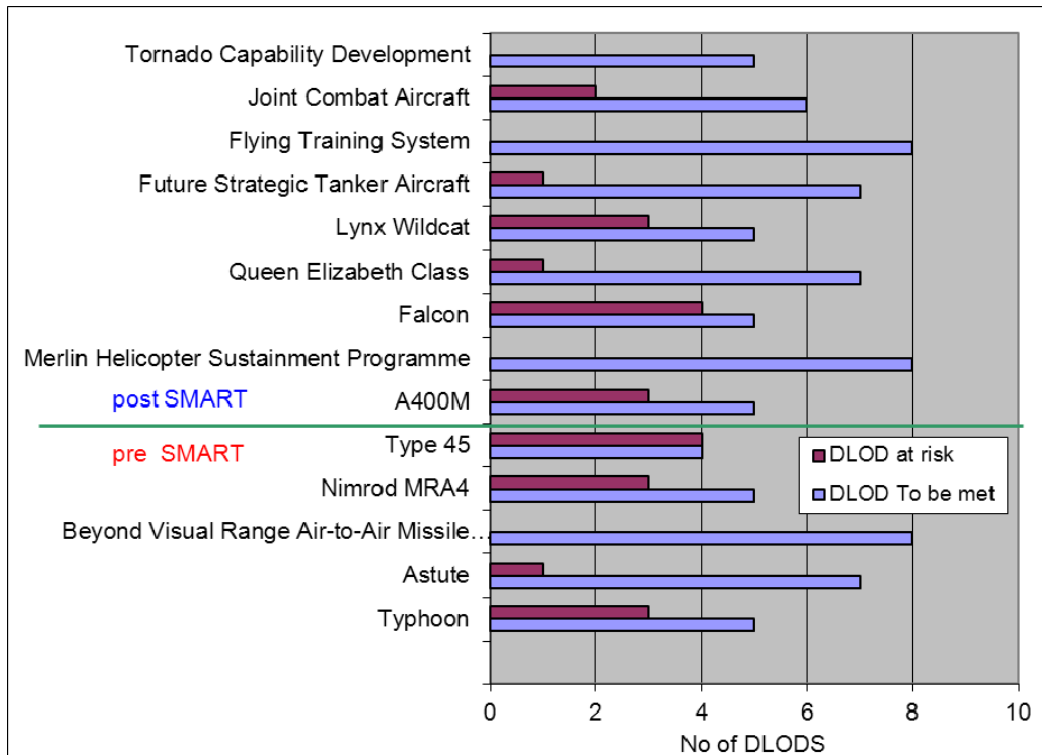

Figure 51 – DLOD Performance of Main Projects 2010

Unlike DLODs, the KPMs are specific to each project. The NAO’s major project reports include DLOD and KPM statistics and these are shown in Figure 51 and Figure 52 respectively.

It can be seen that BVRAAM and Merlin are performing well to both criteria, whereas A400M, Astute and Typhoon are not performing quite as well.

This indicates variability in delivery efficiency that is explored further in the next sections.

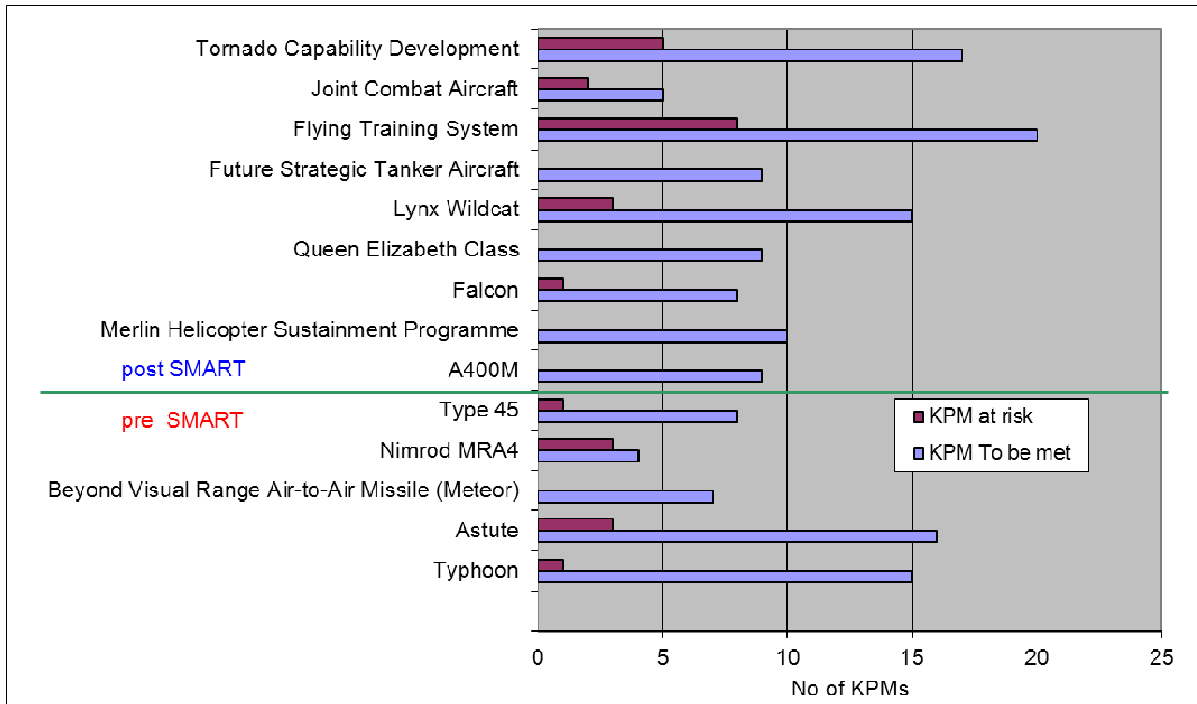

Figure 52 – KPM Performance of Main projects 2010

D.3 Method of Project Analysis

A more detailed look at The Major Projects Report 2010 [137] was taken to establish what might be achievable by identifying issues and their sensitivities in relation to overall performance. It was hypothesised that a problem was likely to be due to one or more of the following that are analysed:

1. Change of priorities

- a. military
 - i. change of threat/priority
- b. political
 - i. budgetary
 - ii. policy changes

2. A misunderstanding in one or more areas

- a. A technical issue that had been underestimate
- b. A requirement that was not identified at an early stage
- c. An emergent technical problem

| Programme Change (PC) | Technical Change (TC) | Friction - a 'knock-on' effect | Financial Adjustments (FA) |
|---|--|--|--|
| Changed delivery profile Unidentified variance Removing requirements for sub-systems Defer feature or reinstate it Contract date changed Change total number of deliverables Programme realism re-evaluated programme risks re-evaluated | Specification change Equipment added, deleted or modified Equipment features delayed or brought forward Modifications to special to type equipment Training needs added deleted or modified Changes to Spares and Deployment Kits | Changes in timing of expenditure Delay of programme Slip of payments and associated equipment Subsequent contract renegotiation due to changes Improved understanding - including adjustment for actual sunk costs | Variation in Cost of Capital Charge Changes to Cost of Capital Charge and Sunk Costs Correction of previous years treatment of deliveries Transfer from Resource/Capital Departmental Limit Exchange rate changes Changes in inflation rate |

Table 28 – Project Analysis Categories

These were analysed into 4-categories as described in Table 28, the descriptions are taken from actual issues identified in the NAO report [138]:

D.4 Programme and Technical Changes

It will be appreciated from the content list for these two categories, that the 'prime-mover' issues are likely to be one or both of Programme or Technical Changes. If these were removed, the 'knock-on' effects would not exist and it is likely that the financial issues (changes in financing the project) would also be removed, or the need for them greatly reduced.

It should be pointed out that it is not always simple to allocate a particular issue to a single category. For example, a programme delay may result in technology advancing during a delay period, such that technical changes need to be introduced. This situation would result in a further delay with financial consequences. One example of a situation like this is the Typhoon [139] Vol 2 page 192:

Development revised cost (+£55m) as a result of revised assessment of change proposals and risk.

Tranche 1 production revised cost (+£50m) as a result of refined assessment of retrofit programme and interoperability modifications.

Each issue was generally assigned to the most likely primary cause - programme delay. Technical change involves explicit cost change for the supplier and/or the MoD so it is vigorously resisted by both parties. It could be argued that a technology update would have been needed anyway and this would have caused a programme delay. Some such issues were allocated to technical causes where they could be identified. In fact, it does not substantially affect the overall conclusions as will be seen later.

D.5 Financial Adjustment

The financial control of projects and balancing budgets has been, and still is, a main focus of defence procurement – given that technical requirements are being met. When a project starts to slip, its contingency budget is brought into play and an item 'Risk Differential' holds the contingency money. The amount of contingency money is (NAO definition):

“the most likely (50%) and the highest acceptable (not to exceed e.g. 80%) estimates at Main Gate”

This budget can be moved to offset the loss. It is not until the actual overspend exceeds the contingency fund that a loss is declared. At a lower level of adjustment, VAT and exchange rate effects adjust the financial costs.

D.6 Cost of Change

The costs of change have been referred to as 'friction', the effect of any changes increases the overall costs, even though the purpose of introducing the change is often to reduce short-term spending. A project suspension is a typical example. This may reduce the money spent in the current year, often with the penalty of increased total cost. Colloquially the phrase 'spending to save' is transformed into 'saving to spend' as described more fully in section 2.4 but, more formally, this effect is summarised by Prof David Kirkpatrick in his RUSI magazine article June 2010 [140]

A Policy of delay

The failure of MoD project teams to quantify adequately the penalties of delay makes it all too easy for politicians and bureaucrats to delay projects for short-term budgetary convenience.

Appendix E Procurement Options

This appendix presents more information about UOR and PFI contracts, plus a comparison, by value between PFI and EPP contracting methods.

UORs In recent years, since the Iraq and Afghanistan involvements particularly, they have been used for major purchases. It would be assumed that a project the size of Foxhound armoured vehicle or Watchkeeper UAV would be procured by traditional competition but they were both UOR procurements. It is generally reported that the UOR system works well, an example is the Gray Report [141] p8:

The UOR process, which is designed to provide battle winning equipment at short notice to current operations, appears able to deliver better trade-offs between performance, cost and time in the interests of ensuring that, by and large, the frontline receives the right kit at the right time.

It is possible to conjecture why the perceived advantages are achieved:

1. The military planning process failed to predict, in timely manner, the need for these assets
- 4 The time between identifying the need and delivery, using the traditional process (the procurement lead-time), would be too long
- 5 The traditional delivery process is too cumbersome
- 6 The need is clearly understood by those who require it, they feel at risk until the need is met and so are highly motivated to communicate the need effectively to those who can deliver it

The common root is that the traditional method of requirements' analysis and procurement are falling short of today's needs. The delivery mechanism of UORs compared to traditional projects may be quicker but there are downsides. Issues of compatibility with existing equipment will be given cursory attention by the suppliers of UOR equipment. Any obvious

similarities are likely to be adopted but such benefits will not be exhaustively sought. This can lead to (for example) many power generators, with similar characteristics, being required in the field. The actual numbers are not for general publication.

The scope of testing is reduced to the key issues of basic functionality and safety. This can lead to failures if extreme environmental conditions are encountered, for example sustained heat or dust storms. This increases the support costs and reduces availability of the equipment. Actual figures are not for general publication.

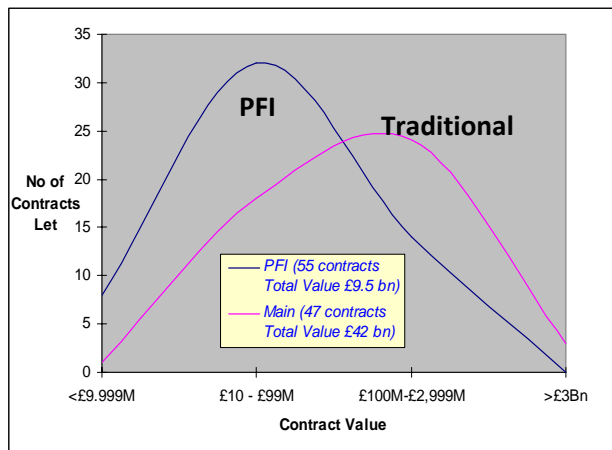

Figure 53 – PFI vs. Traditional Contracts by Value

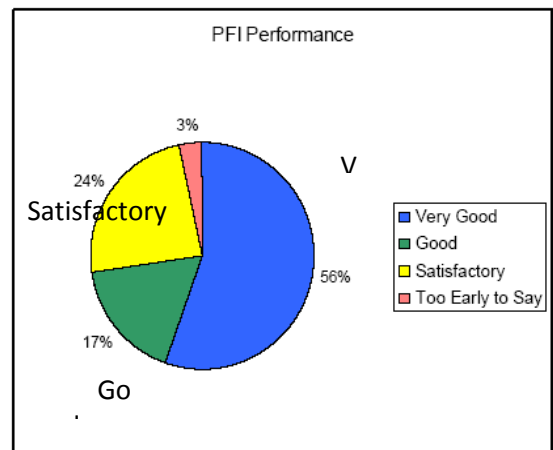

Figure 54 – PFI Satisfaction Report

PFI A comparison of the number and value of traditional and PFI contracts in place is shown in Figure 53 the information was derived from ‘The Major Projects Report 2010’ [142] and ‘MoD PFI Contracts Report’ [143]. It can be seen that PFI contracts let are comparable to traditional contracts in number (56 vs. 47) but their value is much less, £9.5bn vs. £42bn. This is because PFI contracts generally do not involve R&D elements; they tend to be of a support and maintenance type and of lower average value, peaking in the £10-100M rather than £100M+ for traditional contracts.

A review of the performance of PFI contracts was produced by the MoD’s Private Finance Unit in 2005 [144] and it declared itself pleased with the results see Figure 54 that was produced from data in section 4 page 9 of the report. The key findings were [145] Sect 1.4 p3:

PFI in the MOD substantially delivers projects on time and within budget. All 29 projects were delivered on budget. All except three were delivered within two months of the agreed date. For the three projects that did incur delays, contractor failure accounted for the delay in only one project. Circumstances beyond the contractors' control and not related to the PFI procurement delayed the other two;

PFI projects in MOD are performing well and are delivering the services required. All of the project teams surveyed reported that the performance of their PFI project was satisfactory or better. Three quarters of project teams rated the performance of their PFI project as good or very good; and

Long-term PFI contracts in MOD are flexible enough to accommodate future change and to deliver on a sustained basis. The review identified that 85% of projects reported that their PFI contracts were suitably flexible to accommodate change and had effective change management mechanisms. There was however, feedback that changes to the contract require extensive effort and are costly

Only 2 years later, a different perspective was emerging. A good deal for the MoD did not necessarily mean a good deal for the contractors. In 2007 an NAO report 'Improving the PFI tendering process' [146] report that:

Lengthy tendering periods and inadequate preparation of projects have put off some bidders

The Guardian, in Feb 2009 [147] reported that the PFI contracting process had been subject to an industry cartel for price fixing.

one third of PFI projects attracted two bidders or fewer between 2004 and 2006 mainly because of lack of bidder interest

Bid rigging involves submitting an artificially high price so as to give the appearance of competition

The 2008 bank bailout, following the sub-prime mortgage crisis that lead to bank reserves being devalued, caused interest rates to drop. Those PFI contracts that bridged this period suddenly appeared to be costing more than market value would indicate to be reasonable, the contractors found it difficult to borrow money and £2bn of loans were provided by the Government to support contracts [148]. However, the MoD's Private Finance Unit (PFU) at Abbey Wood issued guidelines³⁵ for the conduct of issuing such contracts and they are still in operation. Clearly, the PFI method in its existing implementation may have some attraction but is not a panacea for defence procurement.

Appendix F Software Tools – Summary Tables

This appendix to section 3.6 presents tables with details of the tools reviewed as part of this research.

| System | Manufacturer | Brief Description |
|----------------|----------------------|--|
| System C [149] | OSCI | It is a broadly supported C++ open source language and simulation kernel for modelling and implementing electronic systems. |
| GEDAE [150] | GEDAE | A block-diagram design tool produces executable code. It generates waveform and graphical outputs and allows processes to be grouped into equipment units to simulate equipment I/O. It can provide output in C or FPGA compatible code. |
| MathCAD [151] | MathSoft | It is a mathematically orientated programming language with additional facilities for plotting and visualising information. |
| MATLAB [152] | The Math Works | It is a mathematically orientated programming language with additional facilities for plotting and visualising information. |
| Simulink [153] | The Math Works | A block diagram building tool to produce models that execute simulations |
| Vissim [154] | Visual Solutions Inc | A block diagram building tool to produce models that execute simulations |
| xUML [155] | Kennedy Carter | Executable UML |

Table 29 – Other Modelling Tools

| System | Manufacturer | Brief Description |
|---------------------|-----------------------|---|
| Various FEDEP [156] | Aegis Technologies | A range of tools for supporting implementation of FEDEP HLA systems |
| SIMplicity [157] | Calytrix Technologies | a visual builder for Synthetic environment objects (federates) |
| TENA [158] | SAIC | It is a test and Training Enabling Architecture. A CORBA type system that extends the concept by allowing the models to be modified locally and also HWIL is recognised |

Table 30 - FEDEP/SEDEP Tools

| System | Manufacturer | Brief Description |
|--|-------------------------------------|---|
| E3 Expert; ICEMES; EMMS [159] | Andro Computational Solutions | A range of tools for EM modelling e.g. EMM is a tool intended to simulate and predict interaction between RF sensors. It includes the effects of jamming on multiple sensors. It is used to predict the coverage of a given physical area. |
| FACETS [160] | Thales | RCS prediction based upon Physical Theory of Diffraction. |
| MODTRAN [161] | AFRL | Calculates atmospheric transmission at user selectable wavelengths, protected by U.S. Patent, # 5,884,226; |
| RL-STAP [162] | Rome Labs USA | It is a serious modelling tool from Rome labs using real and synthetic data over simulated terrain. The model is STAP orientated but includes other features. A \$10Bn development in conjunction with CAE Software |
| RADSIM [163] | SAIC | This software uses an overhead image from a Photoshop application and produces a radar image from it. Point cells are added and complex images generated from them that contain texture information. The radar simulation program that scans the image later uses this, and a tiling system is used for loading into memory to cover the part of the scene being imaged by the radar. |

Table 31 – Deeper Abstraction Level Tools

| System | Manufacturer | Brief Description |
|---|--|--|
| Virtio [164] | Open Source Linux | A software development platform that enables early software development and early hardware/software integration of embedded systems through virtual prototyping technology |
| Vista [165] | Summit Design | model, run & verify design prior to transfer to FPGA |
| Sensor Modelling Language (SML) [166] | VisAnalysis Systems Technologies (VAST) | A modelling language developed for spacecraft and other sensor platforms used to observe earth resources. A UML based language with XML object descriptors. |

Table 32 – HWIL Tools

Appendix G Radar Requirements' Research

Section 4.4 introduces the applications that have been considered by this research. This appendix presents the information in more detail.

G.1 Maritime Applications

Maritime radars are generally located on ships. There are also land-based radars used for maritime traffic control, for example monitoring the Dover Straits and harbours. The land-based maritime radars are addressed in the ground-based radar section.

G.1.1 Commercial Maritime Radar

Commercial maritime radars are used for navigation purposes, including collision avoidance. They operate in conjunction with an Automatic Identification System (AIS)³⁶, a radio-based transmission system carried by all larger private and commercial vessels. AIS equipment transmits the identification of the ship carrying it, its position course and speed. This information is typically overlaid on a radar image to provide more situational awareness than provided by just the radar-based view. The main regulatory requirement is defined in British Standard BS EN 62388, the current version being 2008 [167]. This Standard has been reviewed in detail during this research; it applies to radar used by military vessels as well as commercial shipping. The specification includes tests that must be passed by all maritime radars for them to be awarded the type-approval required for the radars to be placed upon the market for sale to ship operators. The tests are designed to assess the radar's performance in terms of accuracy, resolution and discrimination in both range and bearing. (Here, "discrimination" means being able to identify separately, two or more targets that are 'close' to each other, 'close' being defined in the specification). It also defines the assessment of target tracks presented by radar equipment.

³⁶ Information about AIS can be found at the International Maritime Organisation site <http://www.imo.org/ourwork/safety/navigation/pages/ais.aspx>

There is an issue of maintaining tracks correctly when the routes of target ships cause them to come close then separate. Under these circumstances, if the route of a slow ship were to be wrongly associated with a faster one, there would be potential for collision between ‘our’ ship and one of those detected but wrongly assigned a course and speed.

Relevance The Standard helps to define the performance required of equipment being offered to test such systems. In this case, this research-proposed synthetic environment (SE) must be able to:

Allow an operator to select:

1. Ships’ starting position speed and course
2. A number of targets’ starting positions, directions and speeds
3. Each target’ s change of direction and speed (as necessary)
4. Target’s RCS values
5. Sea states (ideally as wind and current parameters)
6. Transmitted frequency, power and modulation information
7. Beam shape of the ship’s transmitter and receiver antennas (usually the same antenna)
8. Landmass locations

The Synthetic Environment must be able to:

1. Update the target positions regularly (in relation to the radar’s scanning rate). The actual positions, speeds and heading must be known accurately (to check those derived by the radar under test)
2. Generate, in real-time, radar returns relating to these scenarios, in a form appropriate to the radar, for injection into the radar’s receiver chain
 - a. Include sea clutter according to a user-defined sea-state
 - b. include land clutter returns
 - c. include Doppler shift
3. Ideally, be able to compare the ship’s radar-extracted data with the ‘ground-truth’ produced by the SE.
4. Provide feedback to the operator as the scenario evolves

G.1.2 Military Maritime Radar

In addition to the needs of commercial ships’ radars, a military vessel has additional requirements. These can be met by other radar equipment. The commercial needs are more likely to be specified as additions to the military

needs. Naval ships need to detect, track and identify air as well as sea targets. They also need to be able to detect and track smaller targets at greater range, reliably, and in more adverse weather conditions than a commercial vessel. In many cases, there will be an additional need for the radar to be used as part of a weapon system to engage hostile targets.

The BAE SYSTEMS Sampson radar, fitted to the T-45 Destroyers and used by the UK Royal Navy, is typical of modern radar. This uses two simultaneously operating planar phased arrays tilted towards the sky and mounted back-to-back. They rotate about a vertical axis to cover 360° in azimuth, the tilt angle and steerable beams support elevation coverage. An alternative is to use more arrays that do not rotate; the Lockheed Martin AN/SPY-1 is an example.

Published data about the Sampson radar [168] reveal it to operate in the E-F bands (the old S-band) and be able to suppress multiple jammers with a monopulse operating mode. High precision tracking of targets in the 3-D space covered by the radar is performed by employing frequency agility and multiple transmitted waveforms.

Relevance This limited information indicates that, in addition to the other features identified so far, the following are important:

1. Frequency agility
2. Multiple transmitted waveforms
3. Adaptive beam-forming
4. 3-D beam formation
5. Support for phased arrays
6. Variable transmit power (implied)
7. Dwell time options (implied)
8. Jamming features
9. High range and bearing resolution

G.2 Military Air Radar

Airborne military radars can be categorised into surveillance and combat types. The Airborne Warning and Control Systems (AWACS) aircraft provide area coverage to detect and identify ships, aircraft and land vehicles. Their control capability allows them to direct combat aircraft to investigate, deter or engage targets of interest.

The Northrop Grumman AN/APY-1/2 [169] radar is a military airborne radar capable of surveillance and its published processing bandwidth is 5 Msamples/sec. The Thales Searchwater radar's published operating frequency is old X-band with a processing bandwidth up to 50 Msamples/sec [170].

Combat aircraft radar specifications are more difficult to access from open sources. They are also multi-mode radars, used for navigation, target detection and tracking, as well as air-air combat including initial engagement for missile attacks. They have air-air, air-ground and air-sea capability. The Selex Captor/ECR90 radar information, published in 2003 on their website 'Eurofighter Technology and Sensors.htm' (no longer available) identified operating modes of the radar as 'long-range air to air', 'close range visual' and 'air to surface'. The radar uses a multi-mode X-band pulse Doppler radar, current information excludes this detail [171]. The radar claims include track-while-scan, data adaptive scanning, and SAR capabilities. The SAAB Gripen radars PS05/A and the phased-array NORA radar, have similar capabilities.

Relevance In addition to the other features identified so far, the following are important:

1. Selection of frequency band
2. Ability to change or inter-leave modes (also for maritime military radar)
3. Clutter types are important (sea, land etc.)

G.2.1 Ground-Based Radar

Commercial ground-based radars are predominantly surveillance radars of various types for airport air-traffic control or ship movement control in confined waters such as harbours or the UK's Dover Straits. They often operate in conjunction with other systems, AIS for maritime-related radars and secondary radar for aircraft. Secondary radar is a transponder system that is triggered by a receipt of a radar signal and returns information similar to AIS data. Chapter 1 of 'Secondary Surveillance Radar' by Michael S. Stevens describes the concept [172]. The military equivalent is the Identification, Friend or Foe (IFF) system that may be turned off, for obvious reasons.

Surveillance radar specifications are generally published for air-traffic control; some of these also have a military application. In 2007, the US Federal Aviation Authority commissioned The Lincoln Laboratory and Michigan Institute of technology to review civil aircraft monitoring in the USA. The study [173] recommended a program to rationalise the existing system by adopting current technology and a multi-mission phased-array radar (MPAR). This provides a useful insight into traditional surveillance radars and the capability required of future equipment. The specification of existing radars and the proposed MPAR are shown in Table 33 - Air Traffic Surveillance Radars in the USA.

| Parameter | Weather Service Radar 88-D | Terminal Doppler Weather radar TDWR | Westinghouse ASR-9; Raytheon ASR-11 | ASR-1; ASR-2; ASR-4 | Proposed multi-mission phased array radar MPAR |
|----------------------|----------------------------|-------------------------------------|-------------------------------------|---------------------|--|
| Wavelength (cm) | 10 | 5 | 10 | 30 | 10 |
| beamwidth | 1° | 0.5° | 1.4°x5° | 2° | 1° |
| Power (kW) | 750 | 250 | | | |
| PW (µSec) | 1.6 or 4.7 | 1 | 1 | | 10-100 |
| clutter suppression | yes | yes | | | yes |
| Doppler | yes | yes | | | yes |
| Weather processing | yes | | | yes | yes |
| Coherent | yes | | | | yes |
| Multi-beam | no | no | | | 160 |
| Processing Bandwidth | | | | | 1 MHz |

Table 33 - Air Traffic Surveillance Radars in the USA

The radars summarised in the table produce pencil or cosecant-squared beam shapes and operate in the D (L) (1-2 GHz), E-F (S) (2-4 GHz) and G-H (C) (4-8 GHz) bands. The proposed MPAR radar would be able to process simultaneously, three frequencies in the 2.7-2.9 GHz band, equivalent to three independent beams. The three beams would notionally be used for monitoring weather, aircraft and the third for independent allocation to aircraft of interest or areas of severe weather. The third channel would be provided with modulation (waveform) to improve range and Doppler resolution for tracking non-cooperative targets (meaning targets without secondary radar transponder responses that provide height, speed, direction and other information). The MPAR beam formations would be changed dynamically to support volumetric or pencil coverage and would have four faces operating simultaneously. These features combine to provide a 1-minute update of all features supported by the radar, including the position estimation of non-cooperative targets.

Military ground-based radars are generally air surveillance and/or missile guidance systems. Air surveillance is dealt with above and missile radars are dealt with in the next section.

Relevance In addition to the other features identified so far, the following are important:

1. Change of pulse widths
2. Coherent operation (also for other military radars)
3. Ability to operate with secondary radars/AIS/IFF

G.3 Missile-borne Radars

Missile-borne radars operate at high frequencies typically L-band (old Q-band) and above, to achieve high positional resolution of their targets at close ranges, often less than a mile, for the final homing operation. In this mode, they operate as conventional radars. Prior to this phase, they may operate in one of three modes:

1. Active guidance – the launch platform computes the intercept vector for the missile and transmits this via a data link
2. Monopulse scan – the angle of the launch platform’s illuminating radar return from the target relative to the flight axis of the missile is used to deduce the required intercept vector. Mono-pulse radars use two or more antennas and compare the phase between them. The angles indicate the azimuth (and elevation) angle(s) of the target relative to the axis of the receiving antenna (p32 [174]).
3. Conical scan (not used in new designs) – the launch platforms illumination radar is received by a mechanically scanning antenna, the angle of which, relative to signal strength of the received signal indicates the required intercept vector (p 10 – 1.2 [175]).

Relevance Apart from a very much higher operating frequency, (the selection of which is already identified as important) and the need for operation at very close distance between the radar and target, there are no additional features.

G.4 Satellite Radars

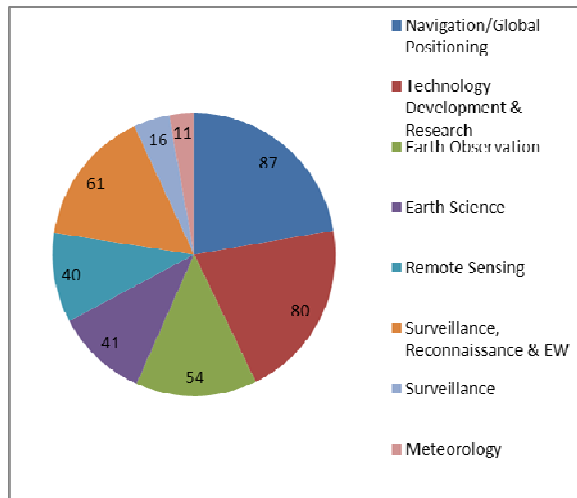

Figure 55 - Uses of Radar Satellites

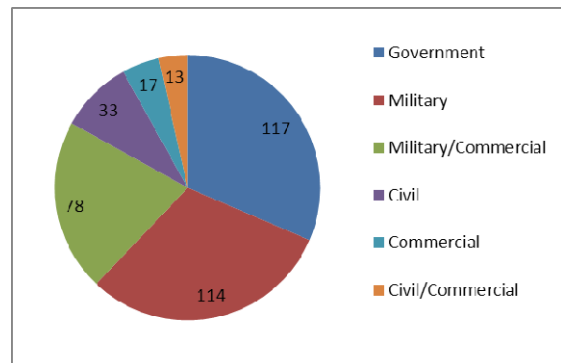

Figure 56 - Radar Satellite Operators

Satellite radars are primarily used for imagery purposes, including mapping, weather monitoring and earth resource assessments (forest-cover, crop yields etc.). Figure 55 shows an analysis of the uses but the information is not easy to confirm. The data shown is based upon information from the UCS Satellite Database³⁷, an independently run organisation. As the chart shows, satellite radars are used for military purposes including tactical observations of ground, air or sea installations and movements as well as battle damage estimation.

Figure 56, also from the UCS Satellite Database, shows the nominal split of radar satellite operators between military/ government and commercial/civil. The information about military uses is difficult to confirm and it may be that some designated for ‘research’ or ‘government’ usage have a military application. All applications and operators are included in the analysis.

The roles of the radars overlap with airborne operation; the main differences are the geographical area covered and the distance between platform and target. The ERS-2, RadarSat-1 and Envisat radars operate in the 3, 6 and 24 cm bands (D-H bands)-bands with G-band and 4 kW peak power being

³⁷ http://www.ucsusa.org/nuclear_weapons_and_global_security/space_weapons/technical_issues/ucs-satellite-database.html

typical. Sentinel 1 has a pulse width of 5-100 μ Sec and PRF of 1-3 kHz (based upon information from the European Space Agency website³⁸. A wider summary of satellite radar parameters can be seen in Table 1.2, page 5 of the NOAA publication 'The SAR Users' Manual' [176]. That table also shows that polarisation is a feature of these radars. This is also a feature of terrestrial radars but has not previously been introduced.

Terrestrial airborne radars may be operating to altitudes of 25 km whereas orbiting imaging satellites operate 700-900 km above the earth. Given a PRF of 3 kHz, the unambiguous range is given by $0.5c/F$ where c is the speed of light and F the PRF; this is 50km for example values. Satellite-borne radar will therefore emit 14 or so pulses before the echoes from first are returned. This is a difference between the simulation requirements of airborne and satellite radar.

Relevance the new features included here are:

1. Very long range between radar and targets
2. Polarisation is of interest.

G.5 Countermeasures

Countermeasures are used to protect fixed or moving targets. Their deployment is intended to make it more difficult for the protected area to be surveyed or attacked. Countermeasures are either passive, chaff³⁹ being an example, or active in various forms including:

1. Randomised continuous modulation of jamming at the frequency of the incident radar
2. Multiple retransmissions of the incident radar waveform and frequency

The first of these produces a 'white-out' in a sector, blinding the illuminating radar. The second produces multiple false targets so that the illuminating radar is likely to lose track on the real target. The return may have a similar RCS pattern to the real target (to form one or more decoys) or

³⁸ <http://www.esa.int/esaCP/index.html>

³⁹ Chaff is a cloud of metallised strips, the size of which are calculated to reflect radar power in particular band

it may just return a Doppler-shifted echo of the illuminating radar's waveform.

Relevance these types of jamming capabilities need to be considered in a test facility.

Appendix H Basic Geometry

This set of calculations is common to the platform and each moving target. First, the distance moved during a 1 mSec period is calculated by using a simple equation of motion. The distance is converted to radians by the relationship shown in (9)

$$\theta_r = \frac{d}{\text{Radius_of_Earth}} \quad (9)$$

The angle is then used to calculate the new latitude of the platform or target as shown in (10)

$$\text{lat}_2 = a \sin(\sin(\text{lat}_1) \cos(\theta_r) + \cos(\text{lat}_1) \sin(\theta_r) \cos(\text{brg})) \quad (10)$$

Finally, the longitude of the new position can be found (11)

$$\begin{aligned} \text{step1 } \text{lon}_2 &= a \tan 2(\sin(\text{brg}) \sin(\theta_r) \cos(\text{lat}_1), \cos(\theta_r) - \sin(\text{lat}_1) \sin(\text{lat}_2)) \\ \text{step2 } \text{lon}_2 &= \text{mod}(\text{lon}_1 - \text{lon}_2) + \Pi, 2\Pi) - \Pi \end{aligned} \quad (11)$$

Once these calculations have been performed on a coarse basis, the new positions can be updated with fine resolution by approximation to a straight line for sub 1 msec calculations. For example, this is done at the time of a radar transmission pulse for radar operation and at the time of a scan for ESM operations. This is important for Synthetic Aperture Radar (SAR) and similar applications where high spatial resolution is required. In this way, sub-wavelength resolutions can be achieved by use of phase angle measurements of distance between the platform and targets.

The distance d_{PT} and bearings between the platform and each target Θ_{PT} are calculated on a similar fine resolution basis according to (12) and (13)

$$d_{PT} = a \cos(\sin(\text{lat}_p) \sin \text{lat}_T) + \cos(\text{lat}_p) \cos(\text{lat}_T) \cos(\text{lon}_p - \text{lon}_T) \quad (12)$$

$$\theta_{PT} = a \cos\left(\frac{(\sin(\text{lat}_T) - \sin(\text{lat}_p))}{(\sin(\theta_r) \cos(\text{lat}_p))}\right) \quad (13)$$

The bearing needs to be subtracted from 2π if the target longitude is greater than that of the platform.

The slant range from platform to target is calculated using triangle geometry equations as shown in Figure 57 (d_{PT} is used to calculate the angle subtended at the centre of the Earth between the R +target height radial and the R +platform height radial).

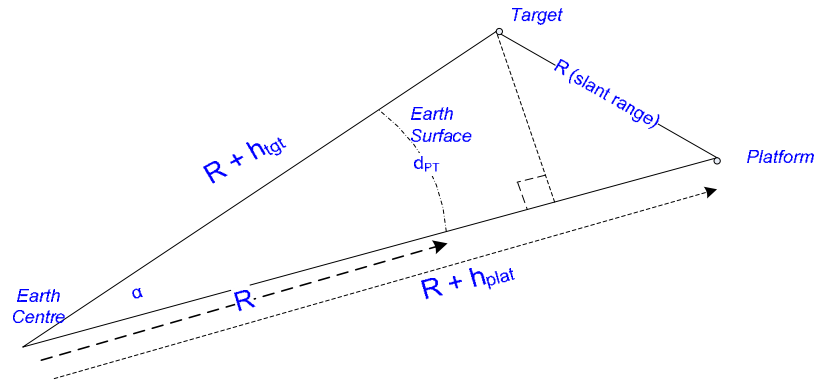

Figure 57 – Platform-Target Slant Range Geometry

The speed and relative angle of the target's course to that of the platform is of importance for some sensor types. The speed at any time is calculated by a simple equation. Clairaut's formula relates the true course to the latitude at any point on the journey as shown in (14)

$$\sin(tc1)\cos(lat_1) = \sin(tc2)\cos(lat_2) \tag{14}$$

where $tc1$ = initial true course (radians); $tc2$ = final true course (radians); lat_1 and lat_2 are the first and last latitudes of the object (platform or target) respectively.

Appendix I Design Verification

The various elements of the design were verified individually using simple scenarios before more complex scenarios were introduced. The following sections describe the simple scenario tests that compare the experimental results with expected results.

I.1 Target Return Amplitude and Range Verification

A scenario was created with a stationary target of RCS 1000m² at 10 km due north of the platform. The amplitude of the return was measured by capturing the I-Q digital values and converting these to Voltage by using the parameters in the implementation model. These values were converted to a power measurement by squaring, adding and dividing by the load impedance (50 Ohms) set in the user interface. (Power = V²/R). The radar equation was applied to obtain the theoretical return power and the results compared. A spreadsheet was set-up to calculate the expected values for a series of Ranges, RCS size with varying Power and gain values.

Target range is a measure of time of return (less pre-pulse offset) and was checked against the known range (10km) of the target given the standard speed of EM waves in air (3×10^8 m/sec).

The values measured were within 0.1% of the calculated values.

I.2 Motion Verification –macro-scale

Several scenarios were set-up to have an object fly from a start location to an end destination; this included a full great-circle route back to the start. A speed was chosen for one run, then doubled for the next and times measured and compared. Several runs were made at varying angles, including polar routes. The earth was modelled with a radius of 6,378,100 metres. The calculations for this use spherical earth equations and equations of motion as introduced in section 4.9.1 on page 135.

The maximum errors on a great-circle loop (40,074.7842 km) were 0.01 km distance error (0.0002%) and 1.5 sec time error (0.001%) for a 40-hour transit time. These were due to rounding errors and accuracy of the computer's reference clock. They are small enough to be discarded because most scenarios intended for this application will have much shorter duration, 3-4 hours typical maximum, with a 500 km maximum radius.

I.3 Motion Verification – normal scale

A target was located at a start position and programmed to move at a fixed speed of 100 m/sec in a direction that would take it over a landmark at 100 km distant. The time of travel was monitored and the display observed to ensure that the landmark was over-flown. A time of 16 minutes 40 sec \pm 0.1 Sec was measured on a stopwatch. When the computer's internal oscillator was used to measure time the error time the error was less than 10 msec. This represents an error of (0.001%).

A linear acceleration was applied to the target for a selected time. This was followed by a different deceleration rate and the time for the target to come to rest was measured. The equations of motion were calculated manually and the time compared. The results were within the 0.01% tolerance that was applied

More complex speed, acceleration, climb and dive rates were entered to cause the target to perform, for example, a 'rectangular' route in 3-D space on a curved earth. These were calculated such that landmarks would be traversed at points in the flight path. The actual routes taken were compared to the predicted and found to correspond to within 0.1 Seconds over a 15-minute scenario.

I.4 Relative Motion Verification

The basic equations applying to distance and bearing calculations on a spherical earth are well proven by a large number of applications that are in regular use – for example navigation equipment. The issues for the test shell amount to ensuring that the processing assets were adequate to achieve required resolution and accuracy. Ten controlled experiments were run with one fixed object and one moving object. The scenario was varied to extend range on a fixed bearing; followed by maintaining a constant range and changing bearing. Finally, scenarios were implemented with both objects moving in controlled ways. The calculated latitudes, longitudes and altitudes were logged and the range-bearing calculations checked by manual implementation of the equations. The tolerable errors were deemed to be 0.01% and these were easily achieved.

Care has been taken in the test shell calculations to use absolute values where possible to reduce cumulative errors. Track plots were achieved by storing old position values but Google Earth offers track plotting as a feature; the stored values are used for the system log that can be transferred (downloaded and/or printed) at the end of a scenario.

I.5 Pre-pulse Timing

The pre-pulse timing signal was verified by incrementing it and noting the range change of a stationary target when the platform was also stationary. The range change was expected to be equal to the delay change x speed of light. The values corresponded within 0.01% of calculated.

I.6 Clutter on/off

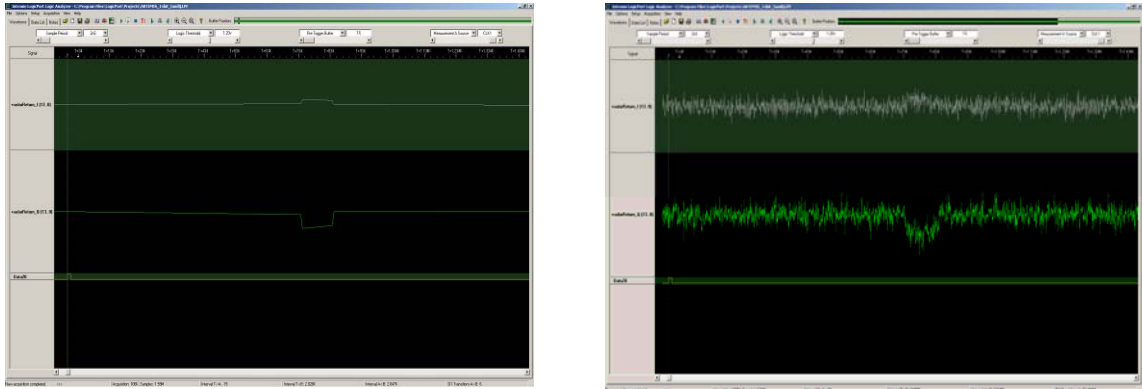

Figure 58 – a 10 M^2 target return with and without 10 M^2 clutter RCS

The time-series plots Figure 58 shows a target return with and without clutter. In this case, the amplitude of the clutter was equal to the amplitude of the target. The I-Q values exhibit the presence of clutter in the right-hand photograph.

I.7 AGC Design Verification

The AGC effect was verified by building a scenario that caused a target to fly away from the radar platform on a fixed bearing. The amplitudes of the target's return were monitored and compared to the settings that had been applied for AGC range. They were found to be well within the tolerance level of 0.01% that was set.

I.8 Range Gating Verification

A target was arranged to move slowly away radially from the platform's position with the platform's beam angle fixed to the direction of the target's travel. The returns were observed and the target appeared at the start range and disappeared at the end range. However, the target re-appeared at a distance equivalent to a PRI plus the start-range time, (as expected) then disappeared again at a range equivalent to a PRI plus end-range time. This is due to range ambiguity and was repeated 4 times. When the PRI was jittered in all but the first appearance, the target jittered, confirming that these later returns were range ambiguous.

I.9 Bearing gating Verification

Stationary targets were placed just inside and just outside the bearing gates with the platform also being stationary. A narrow beam width was selected, the antenna rotated and the targets located. It was found that those outside the bearing gates were not displayed. The beam width was widened to accept the excluded targets and all targets appeared. It was found that the gating angle was accurate to 1-bit of bearing ($360^\circ/4096$).

I.10 Verification of Doppler Implementation

A target was set-up to move radially towards the platform at a fixed speed. The antenna was pointed in the direction of the target and the PRF noted. The phase change of each return was measured.

- Frequency: 5.9960 GHz (Wavelength: 5cm)
- Target range (relative to platform): 1000m
- PRF 1 kHz, Waveform pulse width: 9μsec
- Beam Shape: Isotropic (to be bearing independent)
- Target Shape: Plain Rectangle
- Set the target to move away from the platform at a rate of 1.25cm/s.
- Confirm I&Q phase rotation rate is: 0.5Hz

The Doppler frequency is presented in section 5.1 (page 183). Re-applying equation (8) to find the Doppler frequency gives equation (15).

$$F_d = \frac{2V_D}{c} F_r \quad (15)$$

Applying this equation, the Doppler frequency is 0.5 Hz ($2 \times 1.25 \times 10^{-2} \times 5.9960 \times 10^9 / (3 \times 10^8)$).

The target was organised to move towards the platform and the phase rotation direction was again checked to be reversed but at the same rate of change. At this Doppler rate it was possible to monitor the changing amplitude of the I or Q return on an oscilloscope and to count its oscillations over a period of time measured on a stop watch, from which the rate can be calculated.

Figure 59 shows a view of the Doppler shift.

The radar's PRF is set to 10 Hz as can be seen by the pre-pulse signals in Figure 59 and the phase rotation of the I-Q returns can be seen by the cyclic amplitude changes.

In the right-hand photograph, the phase rotation is reversed compared to the left-hand photograph, as the target recedes. In the first case the I signal lags the Q signal, in the second case it leads.

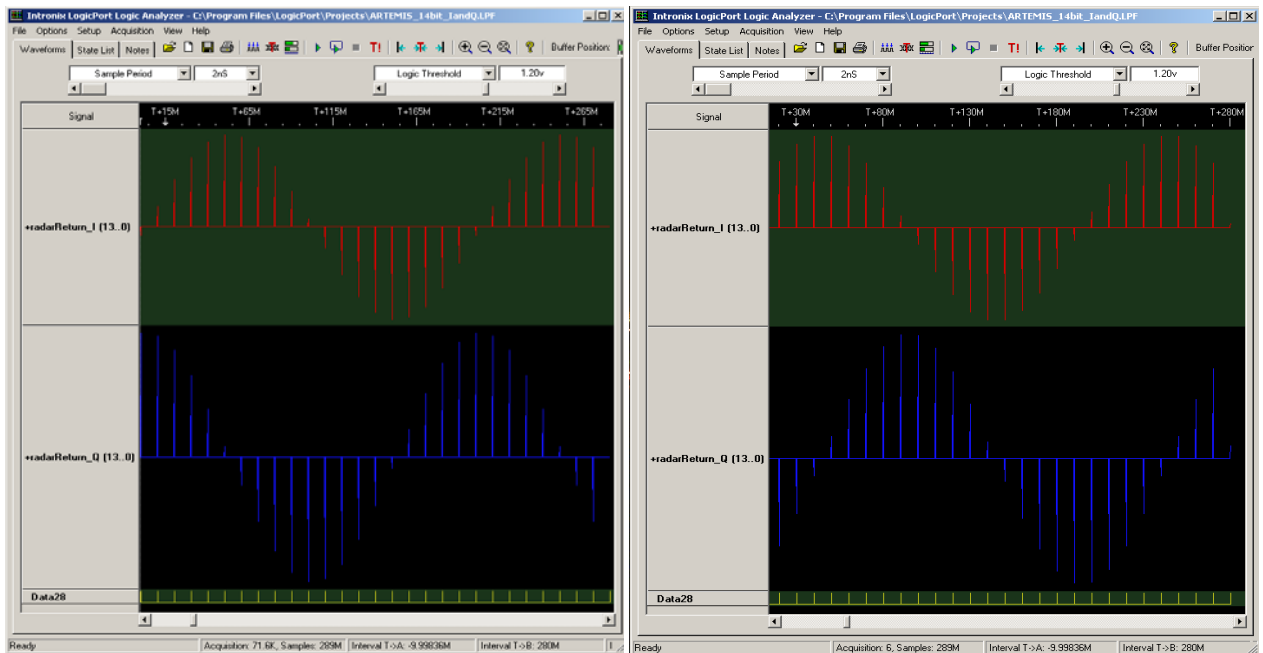

Figure 59 – Doppler - Approaching and Receding

I.11 Verification of Transmitted Waveform Design

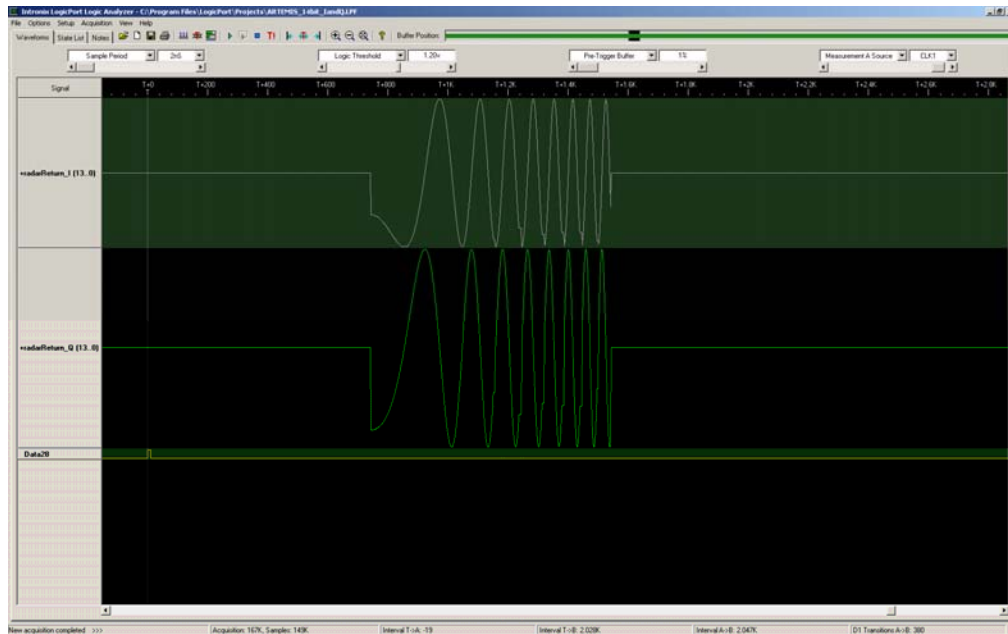

Figure 60 – Waveform rising to 1 MHz

A number of waveforms and target shapes have been used to verify the convolution. The simplest was an impulse waveform with a single RCS reflector. This produced an impulse in the time series and its width was measured. This was repeated for a number of waveforms with different widths. An incrementing frequency waveform with a single RCS reflector produced an incrementing-frequency in the time series as shown in Figure 60. A series of reflectors, to represent a more complex target shape, illuminated with an impulse waveform returned a time series that repeats the waveform at RCS separation times and with corresponding amplitudes.

In all cases, the amplitudes were correct to better than $\pm 0.01\%$ (as expected by 16-bit digital calculation). The times were correct within the appropriate 10 nSec step (the time-series resolution). It is inferred from this that a complex-waveform and complex-target are accurately convolved; the inference was verified by using MATLAB to predict the outcome and comparing with that observed from the radar variant of the test shell.

1.12 Verification of Beamshape Design

Two targets were placed on Google Earth at 45° angular separation from the platform. The closest target was at half the range of the furthest target. A 6° beam with no side-lobes was pointed at the furthest target and a single return was seen at the correct range. The beam width was increased in 5° steps such that the 45° off-beam gain was increased from zero to 0.2; 0.4; 0.6 and 0.8. The second target appeared at half the range of the first, with increasing amplitude as defined by the gain to a measurement accuracy of 16-bits – that of the digital calculation implementation.

Variants of these tests are included as customer acceptance tests with each delivered the radar variant of the test shell.

1.13 Antenna pointing Angle Verification

A beam was created with gain x1 at 0°; 0.5 at 360°/4096 (1-bit) each side of 0°; 0.25 at the steps each side of that. The platform was positioned with targets at 30°; 45° 72°; 180°; 220° and 300° each at different ranges; these angles and ranges being chosen arbitrarily. The beam was pointed in the direction of each target in turn and the amplitude of return measured. The beam was stepped in 1-bit increments each side of the centre position and the amplitude was found to decrease accordingly, showing that the pointing accuracy is correct to 1-bit.