

Heat and Mass Transfer Analysis within a Disc-Shaped Fluidized Sorption Reactor

Marcin Sosnowski^a, Jaroslaw Krzywanski^b, Karolina Grabowska^c, Anna Zylka^d, Anna Kulakowska^e, Dorian Skrobek^f, Marcin Dwyner^g, Waqar Muhammad Ashraf^h, Radomír Ščurekⁱ

^a Jan Dlugosz University, Czestochowa, Poland, m.sosnowski@ujd.edu.pl, CA

^b Jan Dlugosz University, Czestochowa, Poland, j.krzywanski@ujd.edu.pl

^c Jan Dlugosz University, Czestochowa, Poland, k.grabowska@ujd.edu.pl

^d Jan Dlugosz University, Czestochowa, Poland, a.zylka@ujd.edu.pl

^e Jan Dlugosz University, Czestochowa, Poland, a.kulakowska@ujd.edu.pl

^f Jan Dlugosz University, Czestochowa, Poland, d.skrobek@ujd.edu.pl

^g Jan Dlugosz University, Czestochowa, Poland, m.dwyner@ujd.edu.pl

^h University College London, London, United Kingdom, waqar.ashraf.21@ucl.ac.uk

ⁱ VŠB - Technical University of Ostrava, Ostrava, Czech Republic, radomir.scurek@vsb.cz

Abstract:

The depletion of fossil fuels and increased greenhouse gas emissions are crucial factors forcing innovation in various branches of industry and life. In the 21st-century air conditioning is becoming a necessity in terms of well-being and health. Therefore, adsorption cooling technology constitutes a very promising alternative to energy-consuming and environmentally hazardous vapour compression chillers. The main challenge in the wider popularization of adsorption technology is the intensification of heat and mass transfer within the adsorption bed. Therefore, the paper presents different sorption reactor concepts aimed at solving the aforementioned issue. The main parameters influencing heat and mass transfer for each of the analyzed cases are calculated using the computational fluid dynamics code adapted to capture the specific phenomenon occurring in the adsorption bed. The developed numerical model is validated against the experimental data collected on the test stand dedicated to experimental research of innovative adsorption beds operating in various conditions. The results of numerical modelling with the use of the developed coupled CFD & DEM model concerning the adsorbent particles movement and variation in relative temperature of the adsorbent within the fluidization process are presented in the paper. The research allowed to define the design parameters of the adsorption bed that allow intensifying the heat and mass transfer in the adsorption reactor and, in consequence, significantly contribute to the development and popularization of the adsorption cooling technology.

Keywords:

Adsorption chiller; CFD & DEM coupling; Computational fluid dynamics; Discrete element modelling; Fluidization; Heat and mass transfer.

1. Introduction

1.1. Innovation for a sustainable future

The depletion of fossil fuels and the urgent need to reduce greenhouse gas emissions have forced various industries to innovate and develop sustainable alternatives. The major development activities are carried out in energy [1], transportation [2], agriculture [3], and construction industry [4] among which the energy industry is one of the largest contributors to greenhouse gas emissions and climate change. To reduce emissions, the industry has shifted toward renewable energy sources such as solar, wind, and geothermal power. In addition, innovations in energy storage technologies such as batteries and hydrogen fuel cells are also helping to make renewable energy more viable. According to the roadmap presented by the International Renewable Energy Agency [1], renewable energy technologies could provide 90% of the world's electricity by 2050, reducing greenhouse gas emissions by 60%. In addition, cooling systems are responsible for up to 26% of electricity consumption depending on the country [5], with more than 40% of energy consumption in the residential and service sector [6]. This leads directly to the occurrence of peak demand for electricity during the summer period

when the capacity of the power system is the lowest. Such a situation may result in local power deficits or even blackouts, examples of which have already appeared many times. Therefore, the energy industry has been exploring alternative and sustainable energy sources such as solar energy or wind energy but attempts have also been made to waste heat utilization. One of the technologies allowing to effectively utilize the low-grade waste heat for chill generation, seawater desalination or long-term heat storage is the adsorption technology.

1.2. Advantages and disadvantages of adsorption technology

Adsorption technology involves using solid adsorbents to capture and store or transform energy. The process involves the adsorption of a gas or vapour onto a solid surface, which releases heat energy. Several types of adsorbents can be used in adsorption technology, such as zeolites, activated carbons, and metal-organic frameworks (MOFs). Each type of adsorbent has unique properties that make it suitable for specific applications. Metal and carbon nanotube additives to adsorbent are capable to improve its thermal diffusivity and subsequently the overall performance of the process [9]. One of the advantages of adsorption technology is its ability to use low-grade waste heat sources, which are typically not viable for other heat recovery technologies. The recent interest in adsorption cooling technology results from the following benefits of adsorption chillers in comparison to conventional vapour-compression systems:

- powered with a renewable or waste heat source of temperature as low as 50°C [10], which directly leads to a reduction in CO₂ emissions and pollution [11],
- environmentally friendly due to the absence of hazardous and environmentally harmful refrigerants [12],
- capable to desalinate seawater [13],
- almost zero electricity consumption [14],
- no moving parts resulting in high reliability [15],
- quiet due to the absence of compressors and no vibration [16],
- simple control & maintenance [16].

But the widespread application of adsorption chillers is limited by the following shortcomings of adsorption cooling technology:

- low coefficient of performance [17],
- large weight & volume [15],
- intermittent cooling [18],
- high initial procurement cost [18],
- exploitation under vacuum conditions [19].

1.3. Adsorption chiller work cycle

The adsorption process in the chiller is used to transfer heat and produce cooling, with the refrigerant being adsorbed onto the surface of a solid adsorbent material [20]. The work cycle of an adsorption chiller typically involves several subsequent stages, including adsorption, refrigerant transfer, desorption, and refrigerant condensation.

1.3.1. Adsorption

In the adsorption stage, the adsorbent material is exposed to the refrigerant vapour and the refrigerant molecules are adsorbed onto the surface of the adsorbent. The adsorption process is driven by a heat source, which raises the temperature of the adsorbent and facilitates the adsorption of the refrigerant.

1.3.2. Refrigerant Transfer

Once the refrigerant is adsorbed onto the adsorbent material, the next stage of the cycle is the transfer of the refrigerant. This involves the movement of the refrigerant vapour from the adsorber to the evaporator.

1.3.3. Desorption

In the desorption stage, the temperature of the adsorbent is lowered. This causes the refrigerant molecules to be released from the surface of the adsorbent and return to the vapour phase. The desorption stage is the key to the cooling process as it releases the heat that was previously absorbed during the adsorption stage.

1.3.4. Refrigerant Condensation

The final stage of the work cycle is the condensation of the refrigerant vapour back into a liquid. This stage involves the use of a condenser, which is typically cooled using a cooling medium such as water. As the refrigerant vapour flows through the condenser, it gives up its heat to the cooling medium and condenses into a liquid, ready to repeat the cycle.

1.3.5. Thermodynamic cycle

The sorption reactor operates between the condenser/evaporator pressure and the minimum/maximum adsorbate concentration levels. The Clapeyron diagram depicted in Figure 1 illustrates the four ideal thermodynamic stages occurring in the bed i.e., isosteric preheating (1–2), isobaric desorption (2–3), isosteric precooling (3–4), and isobaric adsorption (4–1).

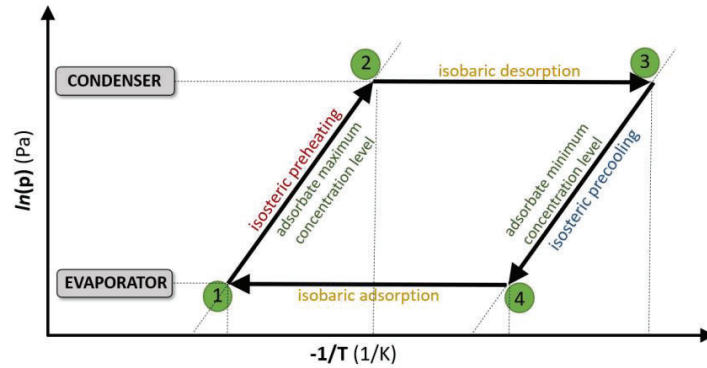

Figure 1. Clapeyron diagram of a basic adsorption chiller work cycle

1.4. Adsorption chiller construction

The operation of an adsorption chiller typically involves a closed-loop system, which includes an evaporator, an adsorber, a condenser, and a desorber as shown in Figure 2a. The refrigerant absorbs heat and evaporates in the evaporator, while it is adsorbed onto the surface of the adsorbent material in the adsorber. The refrigerant is cooled and condenses back into a liquid in the condenser and the desorber is where the refrigerant is desorbed from the adsorbent material, releasing the heat that was previously absorbed. Typically, the adsorber and desorber are combined into one sorption reactor to simplify the system and reduce its overall cost (Figure 2b). Moreover, at least two sorption reactors operating interchangeably are commonly used to assure constant delivery of cool (Figure 2c). The operation of an adsorption chiller is controlled with valves linking the above-mentioned parts of the system. Researchers have also proposed more sophisticated concepts: combined heating and cooling adsorption chiller [21], three-bed adsorption chiller [22] or re-heat two-stage adsorption chiller [23].

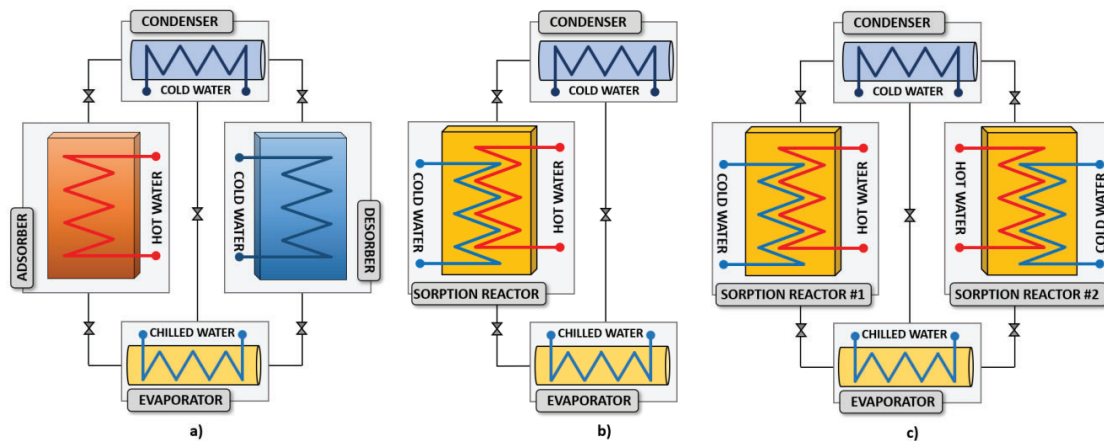

Figure 2. The schematic diagram of the adsorption chiller construction: a) basic concept, b) adsorber and desorber combined into a sorption reactor, c) two sorption reactors operating interchangeably.

1.5. Previous research

The effect of cooling temperature on the performance of a solar adsorption chiller with enhanced mass transfer was investigated in [24]. The authors proposed a new enhanced mass transfer mode with two condensers and a micro vacuum pump for decreasing the desorption pressure. The refrigerant vapour was condensed before being pumped into the receiver, which increased the density of the refrigerant and improved the mass flow

rate with the same pressure and working speed of the pump. The performance of the solar adsorption cooling system with the enhanced model was evaluated and compared with three different cooling temperatures. The results showed that reducing the cooling temperature can greatly improve the coefficient of performance (COP) under the mode of enhanced mass transfer.

The integrated adsorption-absorption system driven by transient heat sources for cooling and desalination was investigated in [25] and [26]. In the first case, the system operated with a relatively low exergy efficiency in the absorption cycle of up to 15.33%. The adsorption bottoming cycle successfully utilised the heat from the absorption subsystem at a relatively higher exergy efficiency of up to 42.69%. The execution of a transient heat source of sinusoidal waveform enhanced the water production by up to 30% and the cooling of absorption and adsorption subsystems by 24% and 15%, respectively. The performance of innovative combined absorption and adsorption cooling systems employing the same evaporating and condensing units was theoretically investigated in [26]. The performance of the proposed system was compared with a separated absorption and adsorption cooling system, combined absorption and adsorption cooling system employing the parallel operation mode, a conventional single-stage adsorption cooling cycle, and other integrated systems available in the literature.

Triply periodic minimal surface structures have been implemented in adsorber/desorber to improve the performance of adsorption cooling systems in [27]. The use of metal triply periodic minimal surface-based structures considerably increased the effective thermal conductivity of the porous media/metal composite due to its large surface area to porous media volume. A fully three-dimensional computational fluid dynamics model was constructed using ANSYS Fluent in the above-mentioned research. This research methodology was also applied in [28].

An experimental and analytical study on the application of adsorber plate heat exchangers in thermally driven chillers was carried out in [29]. The authors investigated the effect of both heat and mass transfer characteristic lengths of two different adsorber plate heat exchangers for application in an adsorption chiller on the adsorption and desorption kinetics. It turned out that the adsorption kinetics is mainly influenced by the mass transfer characteristic lengths, while the desorption kinetics is dominated by the heat transfer characteristic lengths of the adsorbent domain.

Apart from computational fluid dynamics, the artificial intelligence approach is also commonly used in the analysis of adsorption systems. Heat and mass transfer prediction in fluidized beds of cooling and desalination systems was researched in [30]. The developed model allowed the study of input parameters' effect on the outputs and optimize the operating strategy of the bed. Also, the cost of manufacturing adsorption chillers is described in the scientific literature [31] - at a maximum Coefficient of Performance of 1 and maximum Specific Cooling Power of 300 W/kg, the specific selling price of a Silica gel adsorption chiller is €1018 per kW of cooling power.

The effectiveness of adsorption technology in waste heat utilization has been proved in numerous research papers e.g. [32]. The authors conducted experimental and theoretical analyses on the effects of temperature, dew point, and the flow velocity of high-temperature moist air on the regeneration rate in the adsorption heat pump systems.

1.6. Motivation and novelty

Despite the presented numerous research activities aiming to improve the adsorption cooling technology, further research and development are needed to optimize it and make it more cost-effective for commercial applications. Therefore, this paper aims to propose the novel concept of using computational fluid dynamics (CFD) coupled with discrete element modelling (DEM) to analyse the benefits of using fluidization to improve heat and mass transfer within the adsorption bed. Such an approach has never been used before and reveals great potential for further improvement in optimizing the construction of adsorption reactors with numerical methods. It will deliver new knowledge, especially concerning the adsorbate velocity field within the sorption reactor at the operating conditions (absolute pressure below 3 kPa) and it will allow to design the reactor and control the process in a way that maximizes the heat and mass transfer within the whole volume of the adsorbent material.

2. Methods and research objects

As the heat and mass transfer in the sorption reactor are the main factors influencing the overall performance of the adsorption chiller, several design concepts of the reactor were analysed within the carried-out research. They are described in the following paragraphs with the newest concept of fluidized sorption reactor being the main focus of attention.

2.1. Honeycomb sorption reactor

The concept of a honeycomb sorption reactor depicted in Figure 3 was presented in detail in [33]. It contributed to the increased heat transfer surface area and simultaneously assured a compact and lightweight design of the chiller. The computational fluid dynamics analysis performed with the use of the developed endothermic desorption model incorporated into the ANSYS Fluent software allowed defining of the optimal design of the

investigated type of heat exchanger and its correlation with basic factors influencing the performance of the sorption reactor and its dimensions such as the gradient of heating/cooling water temperature, logarithmic mean temperature difference, heat exchanger mass to sorbent ratio, effective mass factor, heat transfer surface to sorbent mass ratio and solid volume fraction. Moreover, the spatial temperature distribution in the reactor as well as the influence of construction material on the above-mentioned factors were defined.

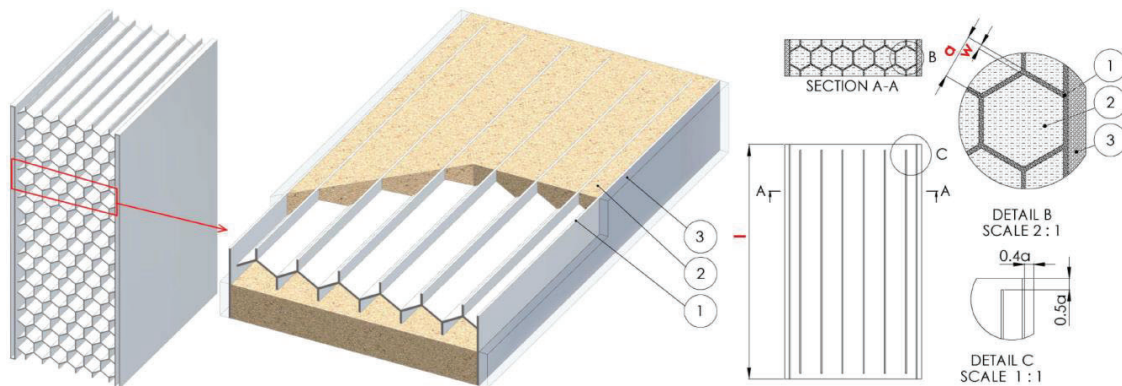

Figure 3. Concept of a honeycomb sorption bed [33], 1 – metal heat exchanger, 2 - sorbent, 3 – heating/cooling water collector

The commercial ANSYS Fluent tool dedicated to computational fluid dynamics was used in this research. However, it does not allow for sufficient consideration of the aspects related to heat and mass exchange during sorption processes. Therefore, the User-Defined Functions (UDF) capability was used to create the model of sorption processes, as it is necessary to take into account fluctuations in the local intensity of heat production or consumption during the exothermic adsorption or endothermic desorption process, respectively. The above-mentioned intensity of heat production or consumption in the sorption reactor depends directly on the local temperature of the sorbent. The mathematical dependence of the sorption intensity and the sorbent temperature was determined as a polynomial function of coefficients defined and validated during previous studies concerning heat transfer in the sorption beds [34].

2.2. Multi-disc sorption reactor

The innovative construction of a multi-disc sorption reactor depicted in Figure 4 was investigated and presented in detail in [35]. In contrast to the commonly applied designs, in a multi-disc reactor, the sorbent is placed in separate disc-shaped packets, and the cooling/heating water washes the packets of sorbet from the outside transferring heat. The adsorbate vapour flows through the fixing net into the sorbent packets penetrating them. The fixing net holds the granular sorbent inside the disc-shaped packets.

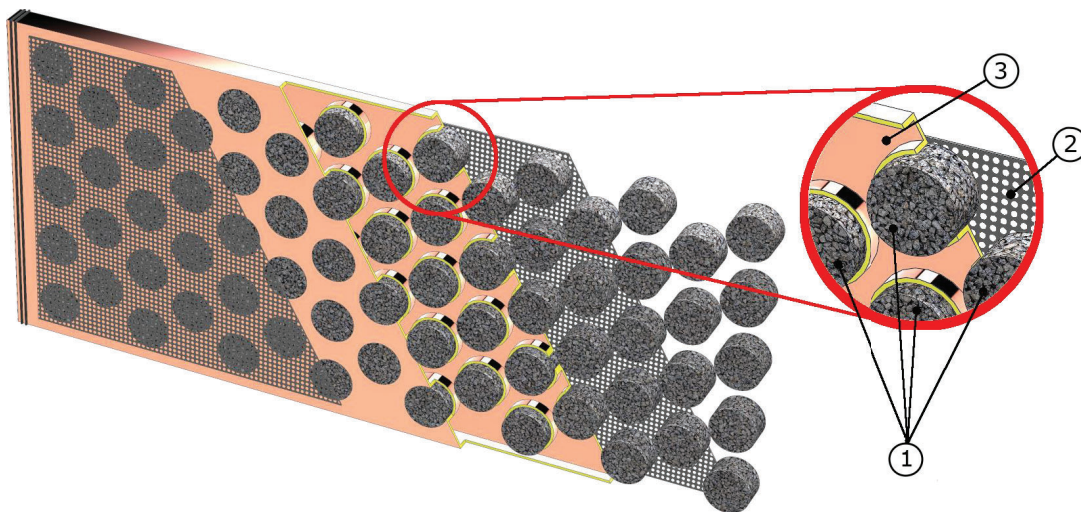

Figure 4. Section view of the investigated multi-disc sorption bed [35]: 1 - disc-shaped sorbent packets; 2 - fixing net; 3 - the main body of the sorption reactor

The proposed construction allowed to place the sorption reactor e.g. in the ceiling of the building or integrating it with solar panels to directly supply the reactor with the necessary heat. Such a solution allows to significantly expand the potential installation sites of the adsorption chillers and thus reduces the need to save a large space for the installation of the adsorption chiller – it is one of the main disadvantages of these devices. Another advantage of the proposed solution is its potential for scalability by adjusting the number of sorbent discs to the expected cooling capacity of the adsorption chiller or the possibility of installing two or more multi-disc sorption reactors with sorbent packages one above another with the space between them being a vapour collector [35].

2.3. Disc-shaped fluidized sorption reactor

The low coefficient of performance of the conventional fixed-bed adsorption chillers is one of their main disadvantages. It results from the low heat transfer in the sorbent beds. One of the well-known methods, allowing to improve the heat transfer coefficient between the porous material and the immersed heating surface is fluidization [36]. Therefore, based on the best practices and numerical models developed and validated within the research concerning honeycomb sorption reactor and multi-disc sorption reactor, the novel concept of a disc-shaped fluidized sorption reactor has been proposed to maximize the coefficient of performance of the adsorption chiller.

2.3.1. Experimental test stand

The experimental test stand was adapted to investigate the operation of the disc-shaped fluidized reactor and to deliver experimental data necessary to validate the developed numerical model of the sorption reactor described in paragraph 2.3.2. Coupled CFD & DEM.

The schematic diagram and the photograph of the experimental test stand are depicted in Figure 5. The test stand consists of a bottom tank operating as an evaporator and an upper tank equipped with an interchangeable sorption reactor. Both tanks are connected to the vacuum pump and to each other via valves controlled individually by the data acquisition and control unit. Both tanks are equipped with electrical heating and an additional inlet/outlet to be supplied with liquid medium (water) for cooling or heating. Moreover, mass sensors, absolute and relative pressure sensors and temperature sensors are installed in both tanks. A detailed description of the experimental test stand is provided in [37].

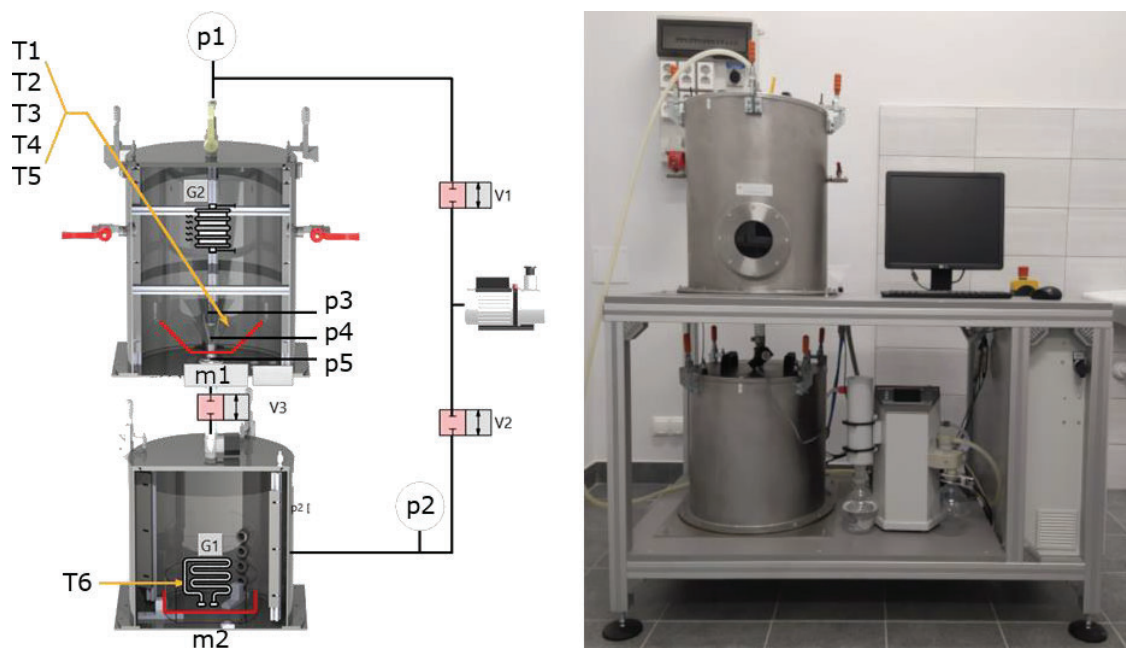

Figure 5. Experimental test stand: schematic diagram (left) and photograph (right)

The top tank can be equipped with different types of sorption reactors and for the purpose of the research the investigated disc-shaped fluidized reactor depicted in Figure 6 was installed in the test stand. The diameter of the reactor was 30 mm and the height of the adsorbent material bed was 30 mm at steady state. The spherical silica gel of 500 μm diameter and bulk density equal to 780 kg/m^3 was used as the adsorbent. The initial pressure in the top tank was 1500 Pa and 2500 Pa in the bottom tank resulting in the initial pressure difference of 1000 Pa. This pressure difference was the driving force of the fluidization process in the sorption reactor. The fluidization lasted until the equilibrium of pressure in both tanks which was 20 seconds.

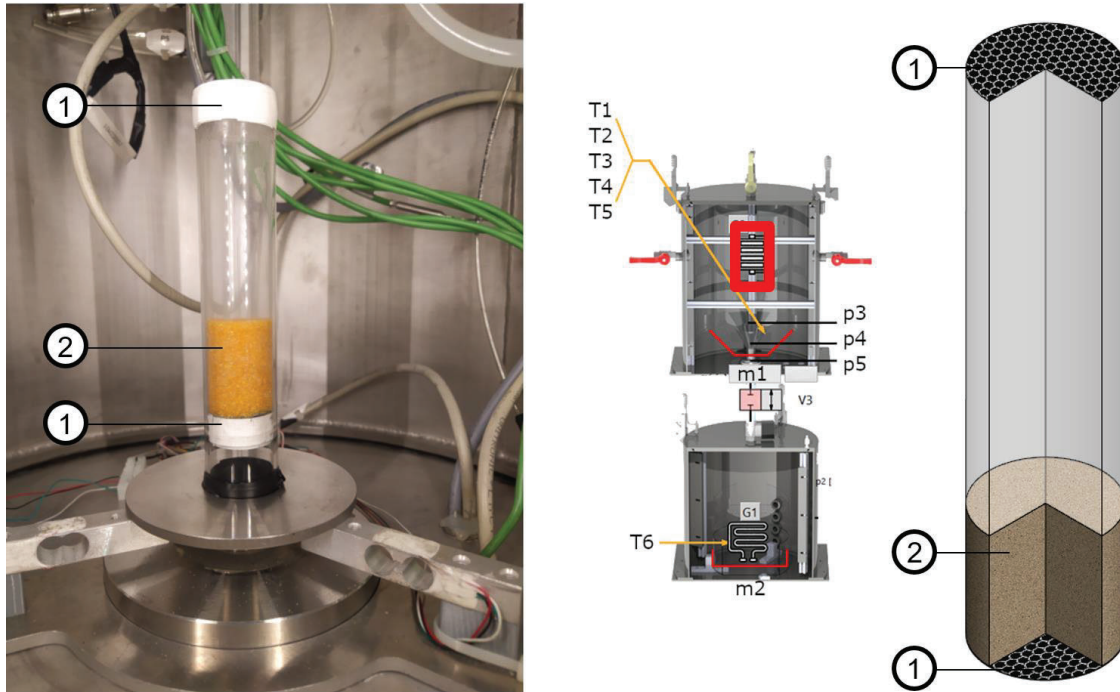

Figure 6. Disc-shaped fluidized sorption reactor: 1 – fixing net, 2 – silica gel

2.3.2. Coupled CFD & DEM

The detailed numerical analysis of the disc-shaped fluidized reactor is a challenging task due to the lack of suitable models. Therefore, the carried-out research aimed to develop a comprehensive model coupling the computational fluid dynamics code with the discrete element method. Such an approach is a promising alternative for modelling granular-fluid systems, expanding the range of coupled particle-fluid processes that can be managed with numerical simulations. Two-way coupling, in which the fluid flow affects the particle movement and the particle flow influences the continuous phase behaviour was applied within the research. Complex phenomena such as heat and mass transfer in a fluidized reactor can be handled with such configured tools after further expanding their standard capabilities with an adsorption/desorption model.

Therefore, the numerical research was divided into two stages: (1) adsorbent particles movement and heat transfer with wall-particle and particle-particle interactions, and (2) additional analysis with a user-defined function capable to take the heat and mass transfer resulting from the sorption processes into account. The results presented below are obtained within the first stage of the research.

The developed model was validated using the data registered on the experimental test stand presented in paragraph 2.3.1.

3. Results

The results of numerical modelling with the use of the developed coupled CFD & DEM model concerning the adsorbent particles movement and variation in relative temperature of the adsorbent within the fluidization process lasting 20 seconds are presented in Figure 7 for time step equal 1 s. The initial pressure difference equal to 1 kPa between the bottom tank (evaporator) and the upper tank induced the flow of the adsorbate (water vapour) directed towards the upper tank. Within the first second of the process, all the adsorbent particles were fluidized by the flow and approx. 40% of the total number of particles were suspended in the upper part of the reactor. The upper fixing net indicated in Figure 6 with the number (1) prevented the particles from being pushed out of the sorption reactor. These particles were suspended there until the ninth second of the process – at that time the pressure difference between the tanks was reduced, which induced a decrease in the adsorbate flow velocity. Therefore, the particles suspended in the upper part of the reactor began to move towards the bottom of the reactor where they were effectively fluidized and the heat transfer was intensified. This process lasted until the sixteenth second when the fluidization stopped due to the decrease of the flow velocity below the fluidization velocity. It can be seen that the heat transfer between the sixteenth and the twentieth second significantly decreased and occurred mostly only in the 10% of the particles located at the very bottom of the disc-shaped fluidized sorption reactor.

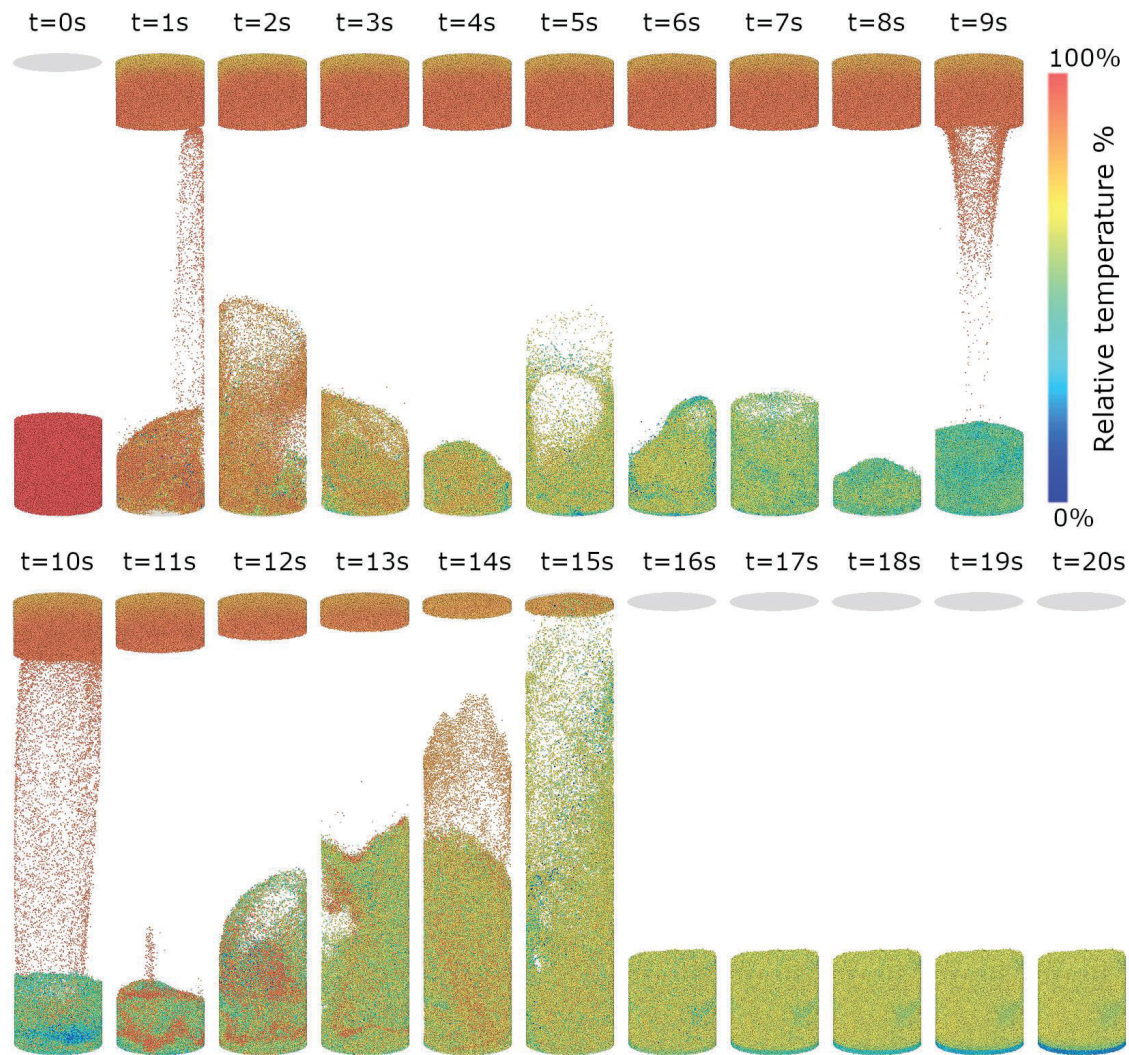

Figure 7. Adsorbent particles movement and variation in relative temperature of the adsorbent within the disc-shaped fluidized reactor for consecutive time steps.

4. Conclusions

The paper presents three concepts of sorption reactors dedicated to adsorption chillers with a special focus on the novel disc-shaped fluidized reactor. All the reactors are analysed with numerical methods. The new approach of coupled computational fluid dynamics and discrete element modelling was applied in the numerical analysis of the disc-shaped fluidized sorption reactor.

The developed numerical model was validated using the data obtained on the experimental test stand.

The results indicate that the coupled CFD & DEM modelling approach is a powerful and cost-effective research tool capable of effectively analysing complicated physical phenomena occurring in the proposed concept of a disc-shaped fluidized reactor. Such an approach has never been used before and reveals great potential for further improvement in optimizing the construction of adsorption reactors with numerical methods.

Further research is needed to extend the model with a user-defined function capable to take the heat and mass transfer resulting from the sorption processes into account. Moreover, the optimal pressure difference inducing the adsorbate flow has to be defined to intensify the heat and mass transfer within the process. The above-mentioned issues will be investigated and presented in the forthcoming papers.

Acknowledgements

This work was performed within project No. 2018/29/B/ST8/00442, "Research on sorption process intensification methods in modified construction of adsorbent beds" supported by the National Science Center, Poland. The support is gratefully acknowledged.

References

- [1] Global Energy Transformation: A roadmap to 2050, International Renewable Energy Agency, Abu Dhabi, 2018.
- [2] Global EV Outlook 2020, International Energy Agency, Paris, 2020.
- [3] Regenerative Organic Agriculture and Climate Change: A Down-to-Earth Solution to Global Warming, Rodale Institute, Kutztown, 2014.
- [4] Bringing Embodied Carbon Upfront: Coordinated Action for the Building and Construction Sector to Tackle Carbon Emissions, World Green Building Council, London, 2019.
- [5] Quality report of European Union energy statistics, European Commission, 2017.
- [6] R. Saidur, H.H. Masjuki, M.Y. Jamaluddin. "An application of energy and exergy analysis in residential sector of Malaysia". *Energy Policy* 2007; 35(2):1050-1063.
- [7] Sztekler K, Kalawa W, Nowak W, Mika L, Grabowska K, Krzywanski J, et al. Performance evaluation of a single-stage two-bed adsorption chiller with desalination function. *Journal of Energy Resources Technology*. 2021;1–22.
- [8] Sztekler K, Kalawa W, Nowak W, Stefański S, Mkia Ł, Siwek T, et al. Experimental study of two-bed adsorption chiller with desalination. In: , editor. *ECOS 2019 - Proceedings of the 32nd International Conference on Efficiency, Cost, Optimization, Simulation and Environmental Impact of Energy Systems 2019*. p. 3143–51.
- [9] Kulakowska A, Pajdak A, Krzywanski J, Grabowska K, Zylka A, Sosnowski M, et al. Effect of Metal and Carbon Nanotube Additives on the Thermal Diffusivity of a Silica-Gel-Based Adsorption Bed. *Energies* [Internet]. 2020;13(6). Available from: <https://www.mdpi.com/1996-1073/13/6/1391>
- [10] Hassan, H.; Mohamad, A.; Alyousef, Y.; Al-Ansary, H. A review on the equations of state for the working pairs used in adsorption cooling systems. *Renewable and Sustainable Energy Reviews* 2015, 45, 600–609.
- [11] Pyrka, P. Modelowanie trójzłożowej chłodziarki adsorpcyjnej. *Zeszyty Energetyczne* 2014, 1, 205–216.
- [12] Voyiatzis, E.; Stefanakis, N.; Palyvos, J.; Papadopoulos, A. Computational study of a novel continuous solar adsorption chiller: performance prediction and adsorbent selection. *International journal of energy research* 2007, 31, 931–946.
- [13] Shahzad, M. W.; Ybyraiymkul, D.; Burhan, M.; Oh, S. J.; Ng, K. C. An innovative pressure swing adsorption cycle. *AIP Conference Proceedings* 2019, 2062, 020057.
- [14] Sur, A.; Das, R. K. Review of technology used to improve heat and mass transfer characteristics of adsorption refrigeration system. *International Journal of Air-Conditioning and Refrigeration* 2016, 24, 1630003.
- [15] White, J. Literature review on adsorption cooling systems. *Latin American and Caribbean Journal of Engineering Education* 2013.
- [16] Sultana, T. Effect of overall thermal conductance with different mass allocation on a two stage adsorption chiller employing re-heat scheme. 2013.
- [17] Grabowska, K.; Sosnowski, M.; Krzywanski, J.; Sztekler, K.; Kalawa, W.; Zylka, A.; Nowak, W. The Numerical Comparison of Heat Transfer in a Coated and Fixed Bed of an Adsorption Chiller. *Journal of Thermal Science* 2018, 27, 421–426.
- [18] Kurniawan, A.; Rachmat, A.; others CFD Simulation of Silica Gel as an Adsorbent on Finned Tube Adsorbent Bed. In *E3S Web of Conferences*; 2018; Vol. 67, p. 01014.
- [19] Elsheniti, M. B.; Hassab, M. A.; Attia, A.-E. Examination of effects of operating and geometric parameters on the performance of a two-bed adsorption chiller. *Applied Thermal Engineering* 2018.
- [20] Sosnowski M. Experimental and numerical analysis of multi-disc heat exchanger efficiency in adsorption chillers powered with waste heat. *Journal of Physics: Conference Series* [Internet]. IOP Publishing; 2019;1398:012013.
- [21] Krzywanski J, Sztekler K, Bugaj M, Kalawa W, Grabowska K, Chaja PR, et al. Adsorption chiller in a combined heating and cooling system: simulation and optimization by neural networks. *Bulletin of the Polish Academy of Sciences: Technical Sciences*. e137054–e137054.
- [22] Krzywanski J, Grabowska K, Herman F, Pyrka P, Sosnowski M, Prauzner T, et al. Optimization of a three-bed adsorption chiller by genetic algorithms and neural networks. *Energy Conversion and Management*. Elsevier; 2017;153:313–22.
- [23] Krzywanski J, Grabowska K, Sosnowski M, Zylka A, Sztekler K, Kalawa W, et al. Modeling of a re-heat two-stage adsorption chiller by AI approach. *MATEC Web Conf*. 2018;240:05014.

- [24] Liang, J, Zhao, W, Wang, Y, Ji, X, Li, M. "Effect of cooling temperature on the performance of a solar adsorption chiller with the enhanced mass transfer". *Applied Thermal Engineering* 2023; 219.
- [25] Mohammed, R, Radwan, A, Rezk, A, Olabi, A, Sharma, V, Kalam Hossain, A, Alaswad, A, Abdelkareem, M. "Energy and exergy study of the integrated adsorption-absorption system driven by transient heat sources for cooling and desalination". *Energy Conversion and Management* 2023; 277.
- [26] Hassan, M, El-Sharkawy, I, Harby, K. "Study of an innovative combined absorption-adsorption cooling system employing the same evaporator and condenser". *Case Studies in Thermal Engineering* 2023; 42.
- [27] Gado, M, Ookawara, S, Hassan, H. "Utilization of triply periodic minimal surfaces for performance enhancement of adsorption cooling systems: Computational fluid dynamics analysis". *Energy Conversion and Management* 2023; 277.
- [28] Grabowska K, Sosnowski M, Krzywanski J, Sztekler K, Kalawa W, Zylka A, et al. Analysis of heat transfer in a coated bed of an adsorption chiller. *MATEC Web Conf.* 2018;240:01010.
- [29] Mikhaeil, M, Gaderer, M, Dawoud, B. "On the application of adsorber plate heat exchangers in thermally driven chillers; An experimental and analytical study". *Applied Thermal Engineering* 2023; 220.
- [30] Krzywanski, J, Skrobek, D, Zylka, A, Grabowska, K, Kulakowska, A, Sosnowski, M, Nowak, W, Blanco-Marigorta, A. "Heat and mass transfer prediction in fluidized beds of cooling and desalination systems by AI approach". *Applied Thermal Engineering* 2023; 225.
- [31] AL-Hasni, S, Santori, G. "The cost of manufacturing adsorption chillers". *Thermal Science and Engineering Progress* 2023; 39.
- [32] Wijayanta, A, Ooga, S, Hironaka, S, Xue, B, Fukai, J. "Waste heat for regeneration of a packed bed of zeolite particles". *International Journal of Heat and Mass Transfer* 2023; 203.
- [33] Sosnowski M, Krzywanski J, Grabowska K, Makowska-Janusik M, Nowak W, Sztekler K, et al. Implementation of a honeycomb bed in an adsorption cooling technology. In: , editor. *ECOS 2019 - Proceedings of the 32nd International Conference on Efficiency, Cost, Optimization, Simulation and Environmental Impact of Energy Systems.* 2019. p. 2521–30.
- [34] Grabowska K, Sosnowski M, Krzywanski J, Sztekler K, Kalawa W, Zylka A, et al. The Numerical Comparison of Heat Transfer in a Coated and Fixed Bed of an Adsorption Chiller. *Journal of Thermal Science.* 2018;27(5):421–6.
- [35] Sosnowski, M. "Evaluation of Heat Transfer Performance of a Multi-Disc Sorption Bed Dedicated for Adsorption Cooling Technology". *Energies* 2019; 12(24).
- [36] Krzywanski J, Grabowska K, Sosnowski M, Zylka A, Kulakowska A, Czakiert T, et al. Heat Transfer in Adsorption Chillers with Fluidized Beds of Silica Gel, Zeolite, and Carbon Nanotubes. *Heat Transfer Engineering.* Taylor & Francis; 2021;0(0):1–15.
- [37] Grabowska K, Zylka A, Kulakowska A, Skrobek D, Krzywanski J, Sosnowski M, et al. Experimental Investigation of an Intensified Heat Transfer Adsorption Bed (IHTAB) Reactor Prototype. *Materials.* 2021;14(13).