

Investigations into the *in situ* *Enterococcus faecalis* biofilm removal by passive and active sodium hypochlorite irrigant delivered into lateral canal of a simulated root canal model

S. A. Mohammed¹, M. E. Vianna² M. R. Penny³ S. T. Hilton³ N. Mordan¹ J. C. Knowles¹

¹ Division of Biomaterials and Tissue Engineering, UCL Eastman Dental Institute, University College London, London, United Kingdom.

Postal address: 256 Grays Inn Road, London WC1X 8LD

E-mails: Saif.mohammed.12@ucl.ac.uk

n.mordan@ucl.ac.uk

j.knowles@ucl.ac.uk

² School of Dentistry, College of Biomedical and Lifesciences, Department of Learning and Scholarship, Cardiff University, Cardiff, United Kingdom.

Postal address: Heath Park Campus, Cardiff CF14 4XY

Email: ViannaM@cardiff.ac.uk

³ School of Pharmacy, Faculty of Life Sciences, University College London, London, United Kingdom.

Postal address: 406, 29-39 Brunswick Square, London WC1N 1AX

E-mail: matthew.penny@ucl.ac.uk

s.hilton@ucl.ac.uk

Corresponding author:

Jonathan Campbell Knowles

Division of Biomaterials and Tissue Engineering,

UCL Eastman Dental Institute,

256 Gray's Inn Road, London WC1X 8LD, UK.

Email: j.knowles@ucl.ac.uk

Running title: Biofilm removal by sodium hypochlorite.

Key words: Automated agitation; *Enterococcus faecalis* biofilm; lateral canal; manual agitation; sodium hypochlorite; 3D printing model.

Acknowledgements

The authors declare that there is no conflict of interest. The authors acknowledge that this study is based on ideas and concepts originated, developed and under investigation by Professor Kishor Gulabivala and Yuan Ng, strands of which have been presented at conferences and as Masters Dissertations. This work was partially supported by the Iraqi Ministry of Higher Education through a PhD Scholarship (# 1031).

Abstract

Aim: This study aimed to investigate *in situ* *Enterococcus faecalis* biofilm removal from the lateral canal of a simulated root canal system using passive or active irrigation protocols.

Methodology: Root canal models (n = 43) were manufactured using 3D-printing. Each canal was created with an 18 mm length, apical size 30, a .06 taper, and a lateral canal of 3 mm length, 0.3 mm diameter. Biofilms were grown on the lateral canal and apical 3 mm of the main canal for 10 days. Biofilm of three models was examined using SEM. The other Forty models were divided to four groups (n = 10). The model was observed under a fluorescence microscope. Following 60 s of 9 mL of 2.5% NaOCl irrigation using syringe and needle, the irrigant was either left stagnant in the canal or activated using gutta-percha, sonic or ultrasonic methods for 30 s. Images were then captured every second using an external camera. The residual biofilm percentages were measured using image analysis software. The data were analyzed using generalized linear mixed models. A significance level of 0.05 was used throughout.

Results: The highest level of biofilm removal was with ultrasonic agitation (66.76%) followed by sonic (45.49%), manual agitation (43.97%), and passive irrigation groups (38.67%) respectively. The differences was a statistically significant between the residual biofilm in the passive irrigation and both sonic & ultrasonic groups ($P = 0.001$).

Conclusion: The agitation results in better penetration of the 2.5% NaOCl into the lateral canals. Ultrasonic agitation of NaOCl improved the removal of biofilm.

1. Introduction

It is widely acknowledged that complete eradication of biofilm by root canal treatment would be essential for preventing of periodontitis (Sjögren *et al.* 1997). The treatment

includes instrumentation and irrigation. It has been reported that albeit using instrumentation, it would be not enough for complete elimination of bacteria from the root canal system (Nair *et al.* 2005). The reason for this inadequacy may be related in part to the canal anatomy that does not come into contact with the instrument. Lateral canal is an example of canal anatomies that are difficult to be instrumented and could harbour bacterial biofilms (Ricucci *et al.* 2009). This demonstrates that the use of a final irrigation regimen after the completion of chemo-mechanical canal preparation may contribute to improved debridement in the non-instrumented part of the root canal system (Ballal *et al.* 2009). However, the debriding action of an irrigant may remain elusive when using a needle and syringe alone (Jiang *et al.* 2012). Agitation may be applied to aid the dispersal of the irrigant into the root canal system (Macedo *et al.* 2014). Agitation techniques for root canal irrigants include either manual agitation (Cecic *et al.* 1984; Druttman & Stock 1989; Huang *et al.* 2008) or automated agitation (Cunningham *et al.* 1982; Sabins *et al.* 2003).

More recently, literature has emerged that offers important insights into strategies of irrigant delivery, mixing, and agitation within the root canal system (Hsieh *et al.* 2007; Boutsoukis *et al.* 2010; Layton *et al.* 2015). However, the real-time monitoring of bacterial biofilm removal from the root canal system by NaOCl is not completely understood. Therefore, more knowledge of biofilm-NaOCl interaction within the root canal system is crucial to improve the outcomes of the root canal treatment.

This study investigated the effect of different agitation techniques on the efficacy of 2.5% NaOCl to eliminate the biofilm from the surface of the lateral canal using the residual biofilm, removal rate of biofilm, and the extent of destruction of the residual biofilm as outcome measures.

2. Materials and Methods

2.1. Construction of transparent root canal models with lateral canal and distribution to experimental groups

The root canal models (n = 43) were created as previously described (Mohammed *et al.* 2016). The design of the model used herein consisted of a main canal of 18 mm length, apical size 30, a .06 taper, and a lateral canal of 3 mm length, 0.3 mm diameter located at 3 mm from the apical terminus (Figure 1). Three models were used to examine the biofilm, which were generated on the surface of the root canal model. The other models were divided into four groups (n = 10 per group) according to the type of irrigation protocol. In-group 1 (the passive irrigation group), no agitation was applied. In-group 2 (the manual agitation group), the irrigant was agitated using a gutta-percha cone (GP) (SybronEndo, Buffalo, New York, USA). In-group 3 (the sonic agitation group), the irrigant was agitated using the EndoActivator[®] device (Dentsply Tulsa Dental Specialties, Tulsa, OK, USA). In-group 4 (the ultrasonic agitation group), the irrigant was agitated using a Satelec[®] P5 ultra-sonic device (Satelec, Acteon, Equipment, Merignac, France).

2.2. Preparation of microbial strain and determination of the standard inoculum

Biofilms were grown from a single bacterial strain (*Enterococcus faecalis*; ATCC 19433). The strain was supplied in the form of frozen stock in a brain-heart infusion broth (BHI) (Sigma-Aldrich, St. Louis, Montana, USA) and 30% glycerol (Merck, Poole, UK) stored at -70 °C. The strain was thawed to a temperature of 37 °C for 10 minutes and swirled for 30 seconds using a Vortex (IKA, Chiltern Scientific, Leighton, UK) (Siqueira *et al.* 2002). After thawing, 100 µL of the strain were taken and plated onto a BHI agar plate (Sigma-Aldrich, St. Louis, Montana, USA) with 5% defibrinated horse blood (E&O Laboratories, Scotland, UK) and incubated at 37 °C in a 5% CO₂ incubator

(LEEC, Nottingham, UK) for 24 hours. Bacterial morphology and catalase activity were confirmed prior to the generation of the biofilms. For this, two colonies of the strain were separately removed using a sterile inoculating loop (VWR, Leicester, UK), and catalase test using 3% H₂O₂ (Sigma-Aldrich Ltd, Dorset, UK) and Gram staining test (BD Ltd., Oxford, UK), were performed. In addition, the identification of the strain was achieved by performing 16S rRNA gene sequencing and analysis.

A standard inoculum of 10⁸ CFU/mL concentration was used, which was adapted from a previous study (Al Shahrani *et al.* 2014). For this, six colonies were removed from the agar plate, placed into 20 mL of BHI broth with 5% defibrinated horse blood, and incubated at 37 °C in a 5% CO₂ incubator for 24 hours. BHI containing *E. faecalis* was adjusted to 0.5 absorbance at a wavelength of 600 nm using a spectrophotometer (NanoDrop™ Spectrophotometer ND-100, Wilmington, USA) (Al Shahrani *et al.* 2014). Inoculum concentration was confirmed by determining the colony forming units per millilitre (CFUs/mL) using six ten-fold serial dilutions (Peters *et al.* 2001). This was performed by mixing aliquots of 100 µL bacterial inoculum into 900 µL of reduced transport fluid in 1.5 mL mini tubes (Sarstedt Ltd, Nümbrecht, Germany). From these dilutions, aliquots of 20 µL were plated on BHI agar plates with 5% defibrinated horse blood and then incubated at 37 °C in the 5 % CO₂ incubator for a period of 24 hours. The colony forming units per millilitre (CFUs/mL) corresponding was 1.1 × 10⁸ CFU/mL.

2.3. Generation of single species biofilm (*E. faecalis*) on the surface of the apical 3 mm of the canal model

The sterilisation method of the model was different as the models halves were packed individually in packaging bags (Sterrad 100S, ASP®, Irvine, CA, USA) and then sterilised using gas plasma with hydrogen peroxide vapor (Sterrad 100S, ASP®, Irvine,

CA, USA) for 50 min (Precautions & Flush 2008). The model was then incubated at 37 °C in a 5% CO₂ incubator for ten days.

One mL of standard *E. faecalis* inoculum (1.1×10^8 CFU/mL) was delivered into a sterilised 7 mL plastic bijou bottle that contained the sterilised half model. The apparatus incubated at 37 °C in a 5% CO₂ incubator (LEEC, Nottingham, UK) for 7 days. A sterile syringe (BD Plastipak™, Franklin Lakes, NJ, USA) and a 21-gauge needle (BD Microlance™, Franklin Lakes, NJ, USA) were used to immerse the 3 mm apical portion of the half model. Every three days, half of the inoculum that surrounded the model was discarded and replaced with fresh BHI broth (De-Deus *et al.* 2007). The biofilm on the surface of three root canal models were observed using scanning electron microscopy (SEM) (FEIXL30 FEG SEM, FEI, Eindhoven, Netherlands). For this, the sample was fixed in 3% glutaraldehyde in 0.1 M sodium cacodylate buffer at 4 °C overnight. Then, they were dehydrated in a graded series of alcohol (50, 70, 90, and 100%), placed in hexamethyldisilazane for 5 min and air-dried. Samples were mounted onto aluminium pin stubs, and sputter coated with gold/palladium (Polaron E5000, QUORUM Technology, UK) before examination using SEM. The model halves with biofilms were removed from the plastic bottle and prepared for staining with a crystal violet (CV) stain in order to reveal any relevant changes as a result of the irrigation experiments. Each model half with a biofilm was placed on a microscopic slide. The model was rinsed with distilled water (Roebuck, London, UK) to remove loosely attached cells. Using a pipette (Alpha Laboratories Ltd, Eastleigh, Winchester, UK), 2 µL of CV stain (Merck, Darmstadt, Germany) was applied to the part of the canal half where the biofilm had been generated (3 mm) and left for 1 minute for staining. It was subsequently washed with distilled water (Izano *et al.* 2007).

2.5. Re-apposition of the model halves

Before reassembling the two model halves, a polyester seal film of 0.05 mm thickness (Uniseal™, Buckingham, UK) was positioned on the half coated with biofilm. Any part of the film that overhung the canal boundary was removed using a surgical blade (Swann-Morton, Sheffield, UK) without disturbing the biofilm. The two halves of the model were then held in position using four brass bolts (size 16 BA) and nuts (Clerkenwell Screws, London, UK).

2.6. Irrigation experiments

In all groups, sodium hypochlorite (NaOCl) of 2.5% available chlorine and 12.8 pH was used as irrigating solution. 9 mL of the NaOCl was delivered using a 10 mL syringe (Plastipak, Franklin Lakes, New Jersey, USA) with a 27-gauge side-cut open-ended needle (Monoject, Sherwood Medical, St. Louis, MO, USA). The needle was inserted into the canal just coronal to the organic film or biofilm. The port opening of the needle always faced the model half containing the organic film or biofilm. The syringe was attached to a programmable precision syringe pump (NE-1010; New Era Pump Systems, Wantagh, NY, USA) in order to deliver the irrigant at a flow rate of 0.15 mL s⁻¹. For each canal, a total of 9 mL of irrigant was delivered over a period of 1 minute. In group 1, followed the 60 s irrigation using a syringe and needle, the irrigant was kept stagnant (passive irrigation) in the canal for 30 s. in the other groups (2-4), the irrigating solution was agitated using manual (Group 2), sonic (Group 3) and ultrasonic methods (Group 4).

In the manual agitation group, the irrigant was delivered as in the previous group. Following that, a gutta-percha cone with an apical ISO size 30 and 0.02 taper was placed 2 mm coronal to the canal terminus which was used to agitate the irrigant in the root canal system with a push-pull amplitude of approximately 3–5 mm at a

frequency of 50 strokes per 30 s (Huang *et al.* 2008). A new GP cone was used with each canal model.

For the sonic agitation group, the irrigant was delivered as described in group 1. Following that, the agitation was carried out using an EndoActivator® device by placing the polymer tip of an EndoActivator® device with size 25 and 0.04 taper at 2 mm from the canal terminus, and then the agitation was continued for 30 s with a high power-setting (Ruddle 2007). A new tip was used with each canal model.

For the ultrasonic agitation group, the irrigant was delivered as in the previous group. Following that, the agitation was carried out by placing a stainless steel instrument size and taper 20/02 (IrriSafe; Satelec Acteon, Merignac, France) of Satelec® P5 Newtron piezon unit at 2 mm from the canal terminus, then the agitation was continued for 30 s. The file was energized at power setting 7 as recommended by the manufacturer. A new instrument was used with each canal model.

Following irrigation protocols, the residual NaOCl on the model surface was immediately neutralised by immersing the models in 2 mL of 5% sodium thiosulphate solution (Sigma-Aldrich Co Ltd., Gillingham, UK) for 5 minutes (Hegde *et al.* 2012).

Three models from each group were examined for residual biofilm using SEM. The samples were prepared as described before, and the residual biofilm on the canal surface was imaged at 3, 2, and 1 mm from the canal terminus.

2.7. Recording of biofilm removal by the irrigant

The rate of film or biofilm removal was recorded using a high-resolution CCD camera (QICAM Fast 1479, Toronto, Canada). The camera was connected to a 2.5× magnification lens on a fluorescent microscope. During the time-lapse recording of interactions between the irrigant and the organic film or biofilm, both fluorescing (red

filter) and non-fluorescing (intensity of 2.5 W/m^2) light was used to achieve a better resolution (Figure 2).

2.8. Image analysis

The video-captured recording was separated into sixty images according to each second of footage using Image J 1.4 and micro-imaging software 1.4 (Media Cybernetics Inc., Rockville, MD, USA). The images were analysed using Image-pro Plus 4.5 and ipWin4 software (MediaCybernetics®, Silver Spring, Maryland, USA). Canal surface coverage by residual organic film or biofilm present after every second of irrigation (0.15 mL) was quantified.

2.9. Data analyses

The residual biofilm (%) on the surface of the root canal model with a lateral canal anatomy at each second of 90 seconds irrigation with passive and active 2.5% NaOCl irrigant was analysed using line plots. An assumption concerning a normal distribution of data for the residual biofilm was checked using a visual inspection of the box and whisker plots. The data were normally distributed and therefore the generalised linear mixed models, followed by Dunnett post-hoc comparisons were performed to compare their distributions in the four experimental groups. A similar analysis was performed to analyse the effects of irrigant agitation duration (time) and experimental group (passive or manual, sonic, and ultrasonic active irrigation) on the percentage of residual biofilm covering the lateral canal surface area. A significance level of 0.05 was used throughout. The data were analysed by SPSS (BM Corp. Released 2013. IBM SPSS Statistics for Windows, Version 22.0. Armonk, New York, IBM Corp).

3. Results

3.1 Statistical analysis

The mean (95% Confidence interval) percentages of the lateral canal surface area coverage with residual bacterial biofilm against duration of irrigation(s) are presented in Figure 3. The data showed that the greatest removal was associated with the ultrasonic agitation group (66.76%) followed by sonic agitation (45.49%), manual agitation (43.97%), and passive irrigation groups (control) (38.67%) respectively.

The results from the linear mixed model (Table 1) indicated that there was a statistically significant difference between the residual biofilm on the lateral canal surface area in the passive irrigation group and the automated groups (sonic & ultrasonic) ($P = 0.001$). Amongst the agitation groups, strong evidence of less residual biofilm was found in the ultrasonic agitation group than those in the sonic and manual agitation groups ($P = 0.011$).

Another important finding (Table 2) was that the interval of irrigant agitation interestingly had an influence on the amount of biofilm removed. The amount of biofilm removed using passive irrigation group was significantly less [0.51%/s; (± 0.08), 1.01%/s; (± 0.08)] than the amount of biofilm removed using sonic, and ultrasonic agitation groups respectively ($P = 0.001$). For the agitation groups, the amount of biofilm removed using the ultrasonic agitation group was significantly more [0.07%/s; (± 0.06), 0.49%/s; (± 0.06)] than that using the manual and sonic agitation group respectively ($P = 0.001$).

3.2 Microscopic images analysis

SEM images of the biofilm on the surface of the lateral canal models before and after irrigation are presented in Figure 4.

Taking the biofilm structure of the untreated model into account, SEM images (Fig. 4ai) showed cocci morphology of the bacteria cell. Bacterial cells were often gathered in colonies, and held together by a matrix of extracellular polymeric substance. Complete encapsulation of bacterial cells by the matrix could be observed.

The influences of 2.5% NaOCl irrigation on biofilm at the 3 mm level from the canal terminus are presented in Figure 4 (a_{ii}, a_{iii}, a_{iv}). Although SEM images of passive irrigation (Fig. 4a_{ii}) and manual agitation (Fig. 4a_{iii}) groups showed residual biofilm with obvious ESP destruction and a damaged cell membrane; some bacteria cells appeared flawless. Entire biofilm elimination was associated with automated groups (Fig. 4a_{iv}).

At the 2 mm level, reduction in removal and destruction effect were evident in the passive irrigation (Fig. 4b_i) and manual (Fig. 4c_i) groups, and communities of bacterial cells held by EPS matrix were noted. This effect was more distinct in the former group. Regarding the automated groups, the greatest biofilm deformation and removal was associated with the ultrasonic group (Fig. 4e_i) followed by the sonic group (Fig. 4d_i).

At 1 mm from the canal terminus, both passive irrigation (Fig. 4b_{ii}) and manual (Fig. 4c_{ii}) groups showed no effect and this pattern was reflected in the intact form and structure of the biofilm. The destruction effect of biofilm by NaOCl was noticed in the sonic (Fig. 4d_{ii}) and ultrasonic (Fig. 4e_{ii}) groups. This effect was superior in the latter group. However, unharmed bacterial cells that are enclosed in an extracellular polymeric substance was identified.

4. Discussion

This study set out with the aim of comparing the impact of passive and active irrigation protocols (manual, sonic, and ultrasonic agitation) and time of irrigation on the efficacy of 2.5% NaOCl irrigant to remove biofilm from the wall of a simulated lateral canal of the root canal system. The results of this study did not show any significant increase in the efficacy of NaOCl during manual agitation. Although a greater removal and eradication effect of NaOCl on the *E. faecalis* biofilm was associated with the ultrasonic activation group, it was not enough for complete biofilm removal and dissolution from the lateral canal anatomy.

In the present study, all *in vitro* models were made of synthetic transparent materials. The surface and composition of such materials differ from that of the natural surface found in the root canal dentine. The porous nature of dentine (due to dentinal tubules) may act differently from a solid plastic material. An *in vitro* study that uses *ex vivo* (extracted teeth) to test the antimicrobial action of irrigants would be more relevant in terms of reflecting the clinical situation. Yet, tooth structures are concealed, which makes them unavailable for the direct visualisation needed to assess the antibacterial action of an irrigant during the process of irrigation. In this regard, the models advocated in this study have the advantage that the transparent canal model allows for a direct investigation in a time dependent way, into the removal action of the test targets (biofilm, simulant biofilms) by NaOCl irrigant.

In this study, the root canal model was created with an apical size 30, .06 taper because it has been suggested that the minimum apical size necessary to deliver the irrigant to the canal terminus is size 30 (Khademi *et al.* 2006). A side cut 27-gauge endodontic needle was chosen for this study, as it is commonly used in clinical practice, and to avoid the greater pressure required to deliver the irrigant at a rate of

9 mL per minute, as is the case when using a flat ended 30-gauge needle (Shen *et al.* 2010). A total of 9 mL of NaOCl were used during syringe irrigation protocol as it has been reported that 9 mL were sufficient to remove stained collagen simulating biofilm from the root canal system (Huang *et al.* 2008). The volume of 9 mL per minute (0.15 mL s^{-1}) irrigant was selected as an attempt to improve the solution penetration (Bronnec *et al.* 2010). Furthermore, this rate falls within the range of $0.01\text{--}1.01 \text{ mL s}^{-1}$ reported in previous studies to be used in clinical practice (Boutsioukis *et al.* 2007). One criticism may be generated about the high flow rate that may increase both apical pressure and irrigant extrusion (Park *et al.* 2013); however, it has been argued that the healthy condition of the periapical tissue creates a barrier against the apical extrusion (Salzgeber & Brilliant 1977).

The diameter of the lateral canal of the root canal model used herein was 0.3 mm (300 μm). This may be considered as a limitation as it lies beyond the range of the lateral canals (10 - 200 μm) reported in previous studies using scanning electron microscope (Dammaschke *et al.* 2004) and microcomputer tomography (Al-Jadaa *et al.* 2009) of human teeth. However, this width was selected, as it was adequate for recording the in-situ removal of the bacterial biofilm. In addition, based on our observations on the printing of lateral canal models with a smaller diameter, the inner surface of the canal was incompletely polymerised. Furthermore, the lateral canal of diameter 250 μm , which is larger than the abovementioned range, was used in a previous study to investigate the removal of simulated biofilms from the lateral canals (Macedo *et al.* 2014).

A total of ten days was selected for biofilm growth as it has been confirmed that this period allowed microbial colonization and developed biofilm models. The relevant biofilm model allowed for the controlled investigation and comparison of the

antimicrobial protocols (Halford *et al.* 2012). Antimicrobial susceptibility of generated biofilms over time has been intensively explored. For instance, Wang *et al.* (2012) showed that young biofilm was more sensitive to intracanal medicaments, and bacteria were more easily killed than in old biofilm. It has been urged that the biofilms become increasingly difficult to be eliminated by antibacterial agents between 2 and 3 weeks (Stojicic *et al.* 2013). However, another study suggested the biofilm resistance is inherent and it is possible to generate mature wild bacterial biofilm (*Pseudomonas aeruginosa*) after 5 days incubation (Klausen *et al.* 2003).

In the present study, a fluorescent microscope has been selected to observe and record biofilm removal by NaOCl. The main advantage of this microscope was that it allowed direct vision of the biofilm removal without the need for sample fixation. However, the high resolution imaging proved difficult because of the steeply curved sides of the canal walls, which interfere with light reflection from these areas. Furthermore, it was unachievable to assess single bacterial cell destruction in the biofilm because the lens of the microscope used herein was a 2.5-x objective lens. In this regard, residual biofilms were examined using CLSM, SEM, and TEM to assess cell viability, biofilm structure, and the extent of bacterial cells destruction respectively.

The use of crystal violet stain to render the biofilm visible under the microscope provoked an issue, because the stain may affect the oxidative capability of NaOCl. For this, experiments were performed to examine the effect of crystal violet stain on the oxidative capacity and capability of NaOCl. The results showed that crystal violet, which displayed a fluorescent capacity, showed neutral effect on NaOCl. This was interpreted by the evaluation of the available chlorine and pH of NaOCl before and after the addition of crystal violet. This result may be attributed to the alkaline property

of the stain, or due to their concentration, which was not high enough to affect the oxidative capacity of NaOCl. The experiments were done in triplicate.

Image analysis software (Image-Pro Plus) has been used to analyse the images from the fluorescent microscope. This software has been adopted in other studies in order to analyse images (Huang *et al.* 2008; McGill *et al.* 2008). One criticism that can be made in relation to all image-analysis techniques is that the areas measured are to some extent subjectively chosen by the examiner. In order to reduce this limitation, inter- and intra-examiner assessments were carried out. A semi-automatic approach to measuring the biofilms was applied and imaging software was used to manually draw the template of the root canal outline and quantify the biofilm. The same template was used to obtain and calculate the biofilm area after washing, without further interference of the operator.

Although the method of quantifying the biofilm from the root canal wall showed marked results, a single assessor performed the measurements and therefore there was a possibility of bias. In order to reduce this, a methodology was agreed using a standard protocol for outlining the root canal and for setting the threshold of the stain to be measured. The principal assessor and another observer who was experienced in using image analysis software measured 10% of the images and this was repeated until sufficient inter-observer agreement was achieved (Hartmann & Wood 1990). Another attempt to reduce bias was attained by assessment of the intra-observer reliability. This was performed by recording ten replicate measurements of the residual biofilm in each group at specific intervals (every 10 s of the 90 s irrigation) and comparing the values taken. This comparison showed good agreement between the measurements (Koppe *et al.* 2009). This semi-automatic method provided operator-independent quantitative results.

The results which emerged from the statistical analysis were that NaOCl is necessary to be in direct contact with the *E. faecalis* biofilm to perform total removal and destruction of the bacterial cell (Moorer & Wesselink 1982). This was achieved in all groups at the 3 mm level from the lateral canal terminus, as the port opening of the needle was facing the lateral canal, which may yield a jet with high velocity fluid flow (Boutsioukis *et al.* 2010; Verhaagen *et al.* 2012).

The agitation of the NaOCl could enhance a lateral flow component, and improve irrigant penetration into the side canal (Castelo-Baz *et al.* 2012). However, no complete eradication of biofilm was evident in the passive and manual agitation groups. The possible explanation for this might be that the rate of irrigant refreshment as the irrigant diffused was decreased (van der Sluis *et al.* 2010). As the irrigation procedure continued, the irrigant penetration into the terminus of the lateral canals was enhanced with automated groups (sonic and ultrasonic). These results may be related to the acoustic streaming and cavitation effects that were created by the tip oscillation of the sonic and ultrasonic device within the main root canal (Van der Sluis *et al.* 2005). Nevertheless, NaOCl efficacy was insufficient for complete removal of the residual biofilm. This could be due to fact that the effective diffusion of NaOCl was restricted to the top layers of the biofilm (Renslow *et al.* 2010). Another possible explanation for this is the rapid consumption of OCl⁻ ions of NaOCl during its reaction with biofilm (Moorer & Wesselink 1982). The efficacy of NaOCl was reduced at 1 mm from the lateral canal terminus in all irrigation groups. This observation could be attributed to the reduction in both fluid convection (Verhaagen *et al.* 2014) and irrigant replacement (Wang *et al.* 2014).

The findings are in agreement with de Gregorio *et al.* (2009) findings, who showed that the efficacy of the automated groups (sonic & ultrasonic) was greater than that of

the passive irrigation group. However, the findings of the current study do not support the abovementioned study, which reported that there was no difference between the sonic and ultrasonic agitation groups. This inconsistency may be due to the structure of biofilm exhibiting resistance to antimicrobial agents (Roberts & Mullany 2010) when compared to the contrast media used in the de Gregorio et al. study.

Further studies, which take the multi-species biofilm variable into account, will need to be undertaken.

5. Conclusion

Within the limitation of the present study, the removal effect of NaOCl on the bacterial biofilm was limited to the 3 mm level from the lateral canal terminus. The agitation of NaOCl results in better penetration of the irrigant into the lateral canals. Ultrasonic agitation of NaOCl improved the removal of biofilm.

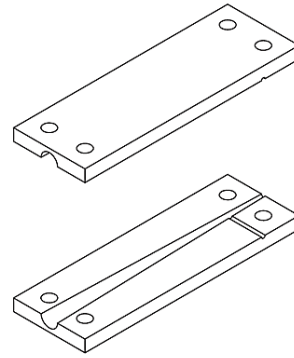
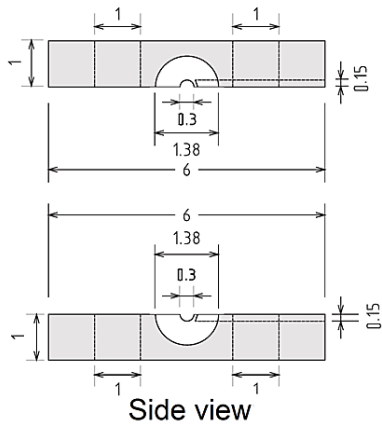

Side view

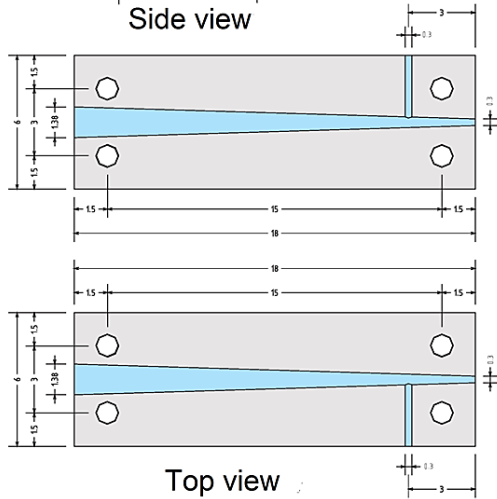

Half canal (Top mould)

Half canal (bottom mould)

Top view

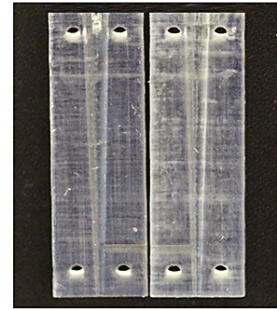

Printed canal model

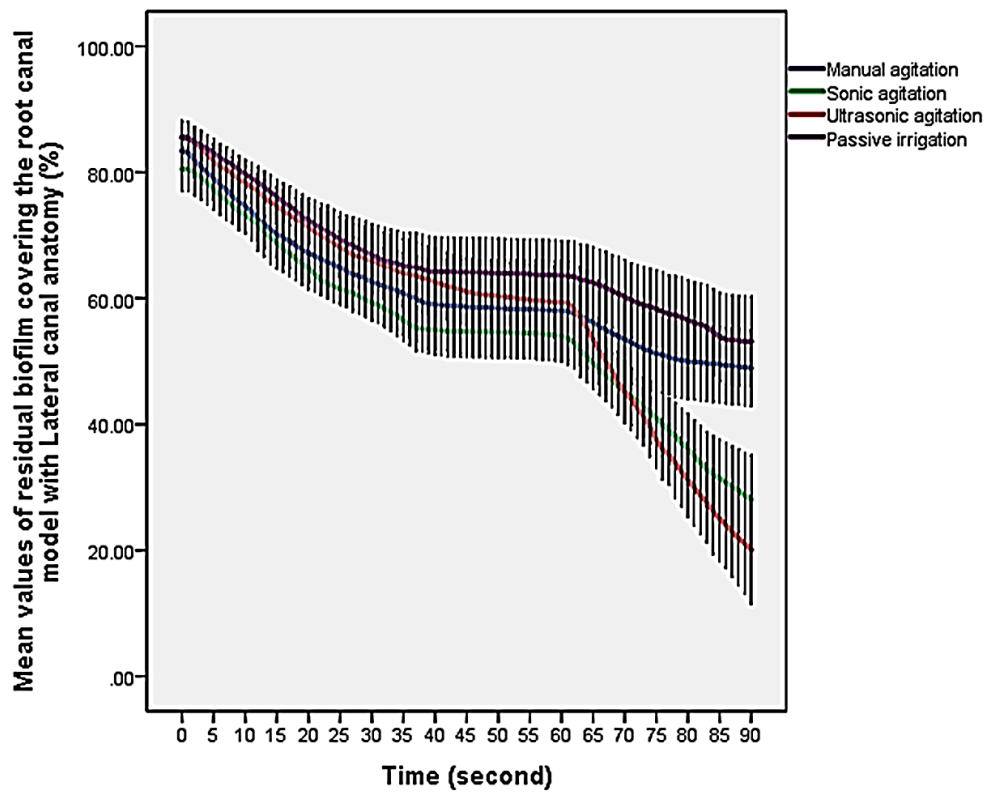
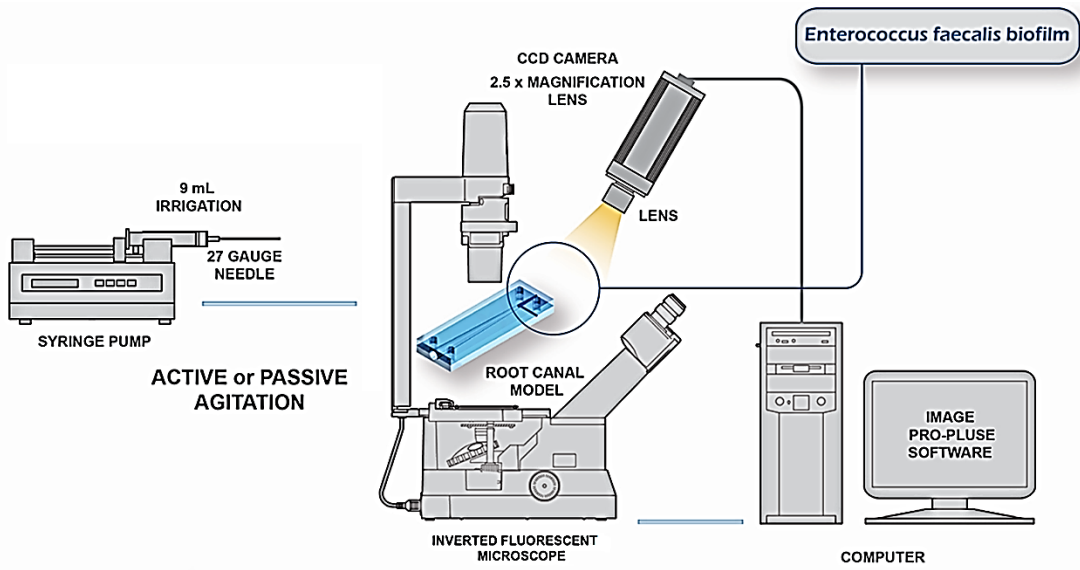

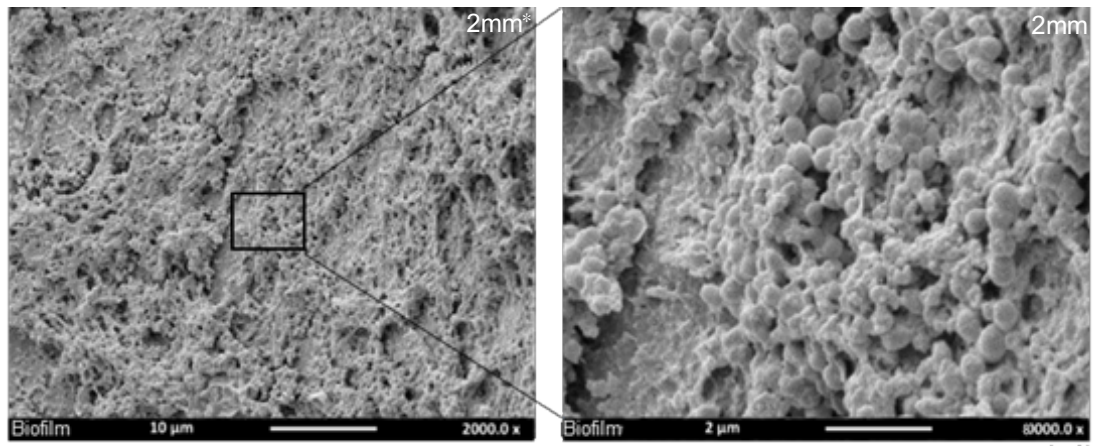

(ai)

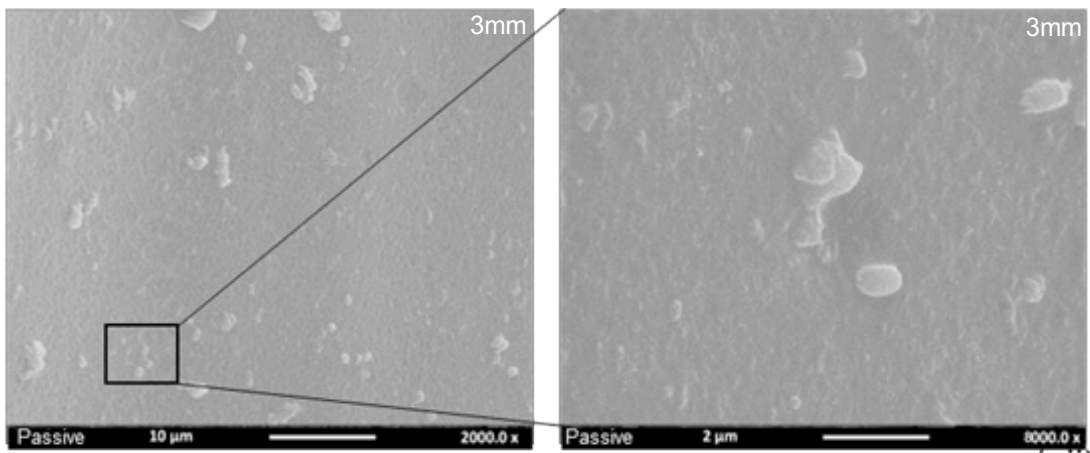

(aii)

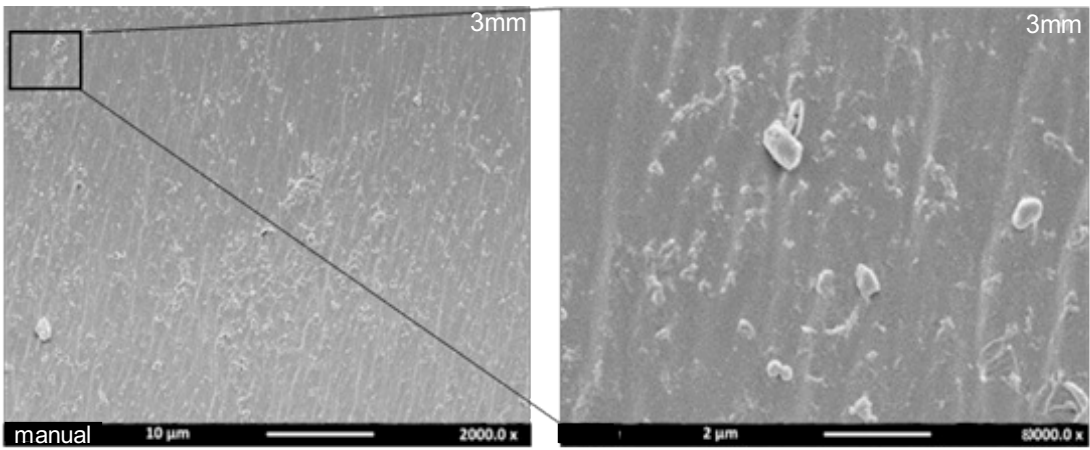

(aiii)

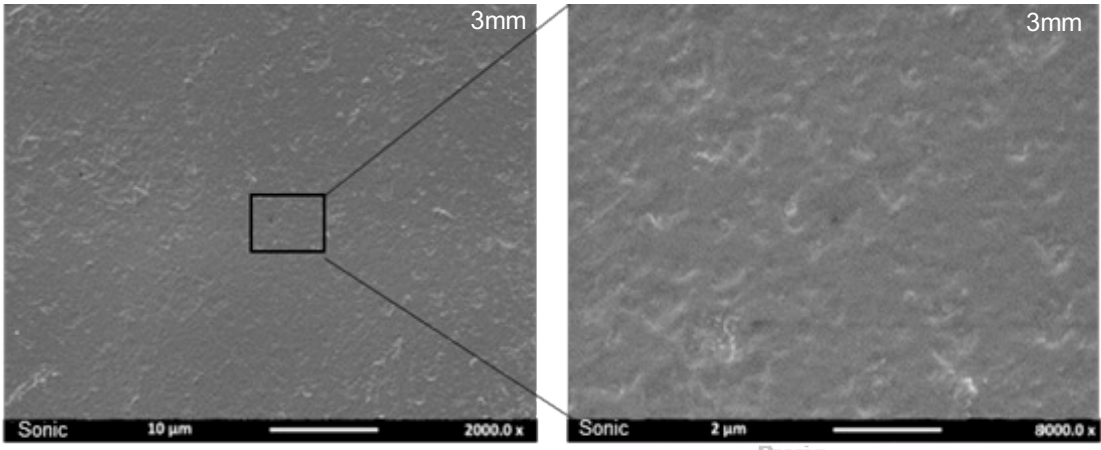

Passive (aiv)

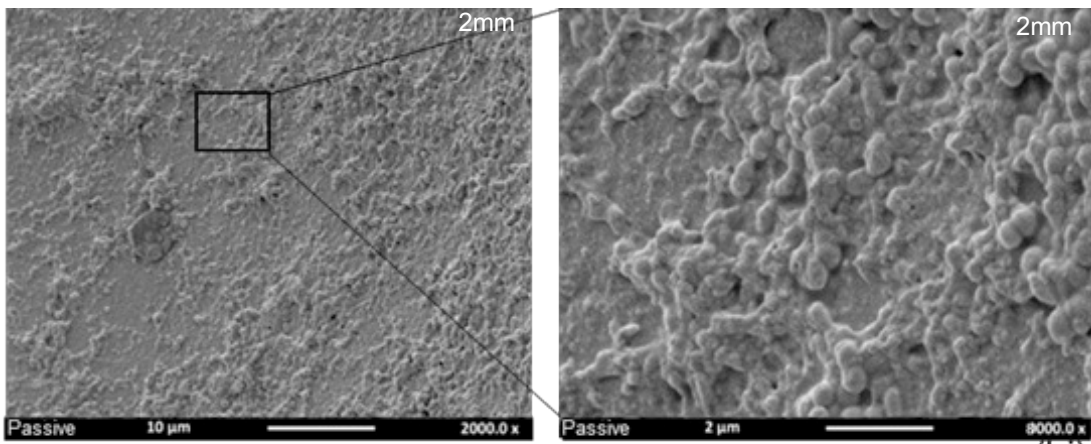

(bi)

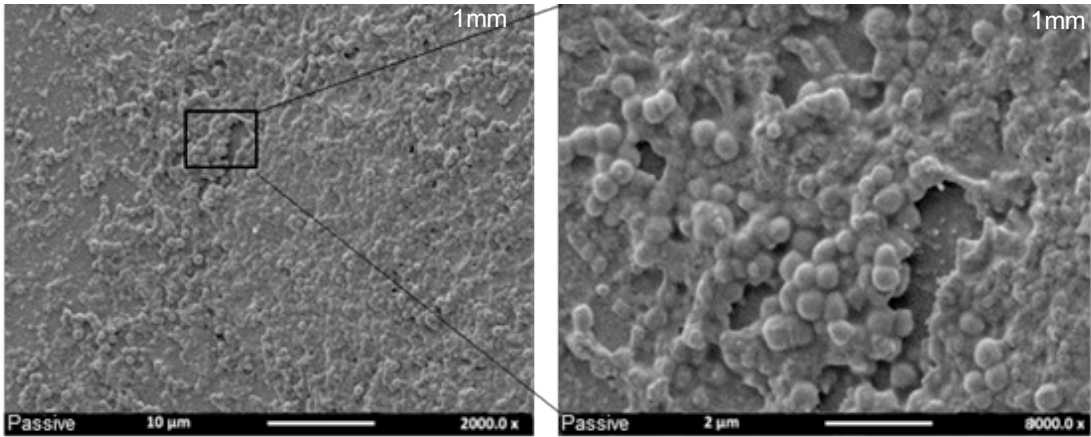

(bii)

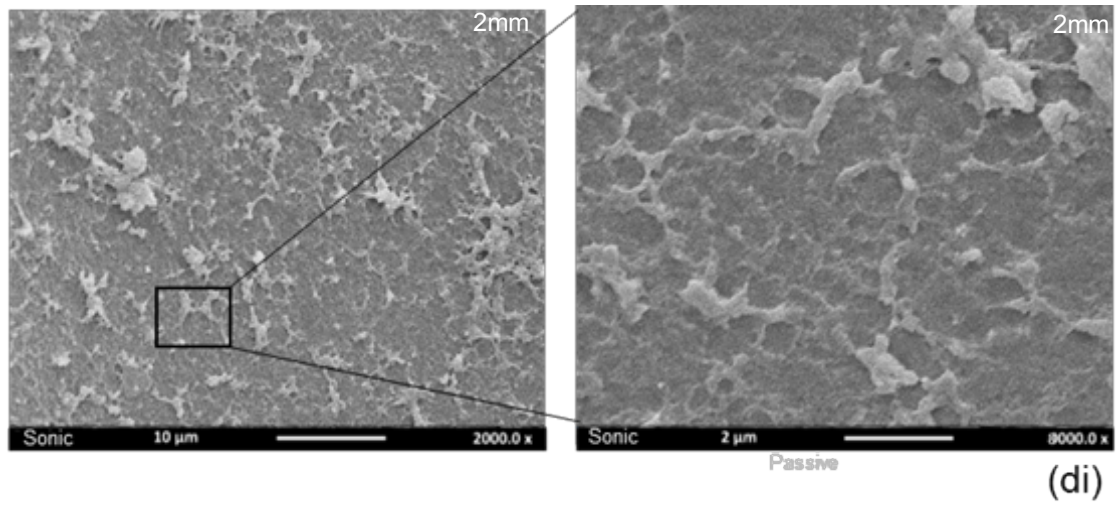
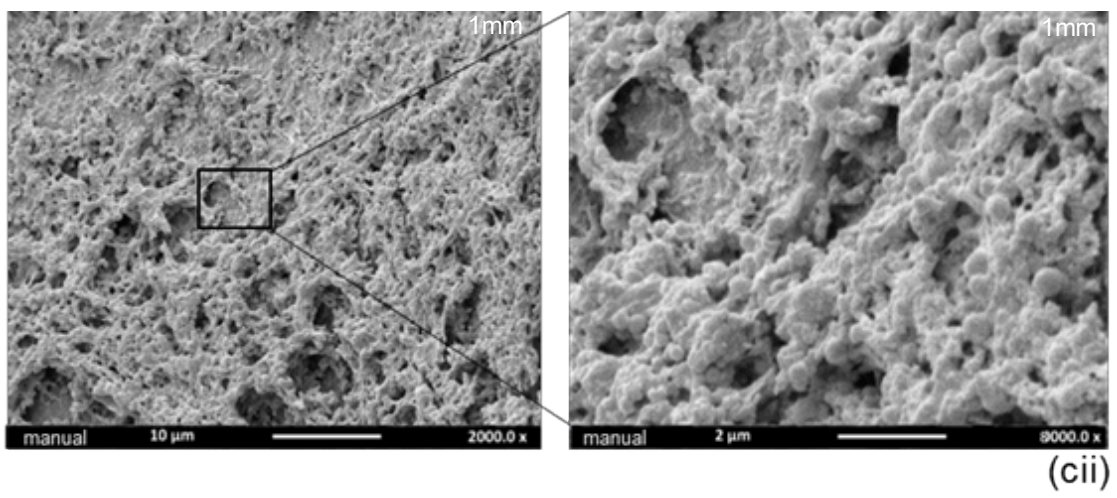
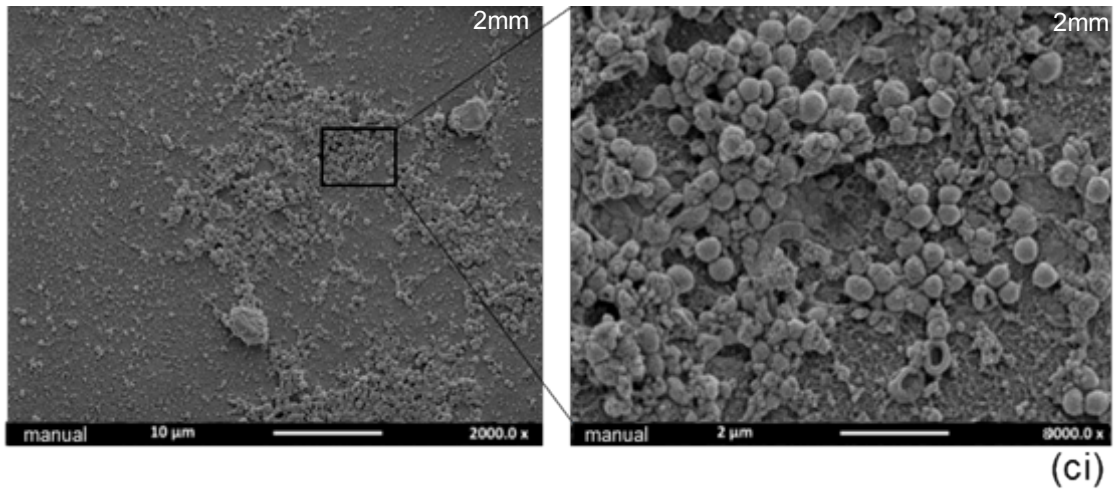

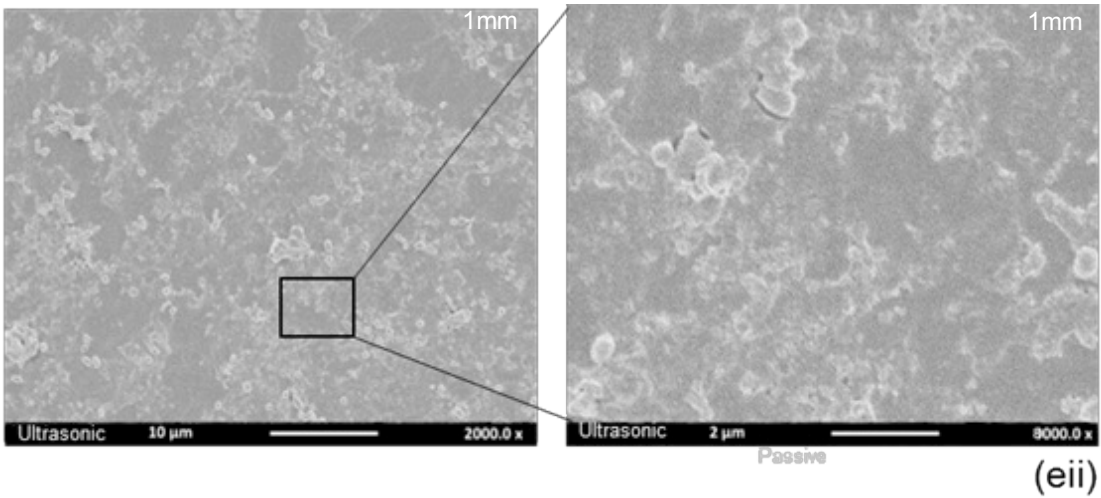
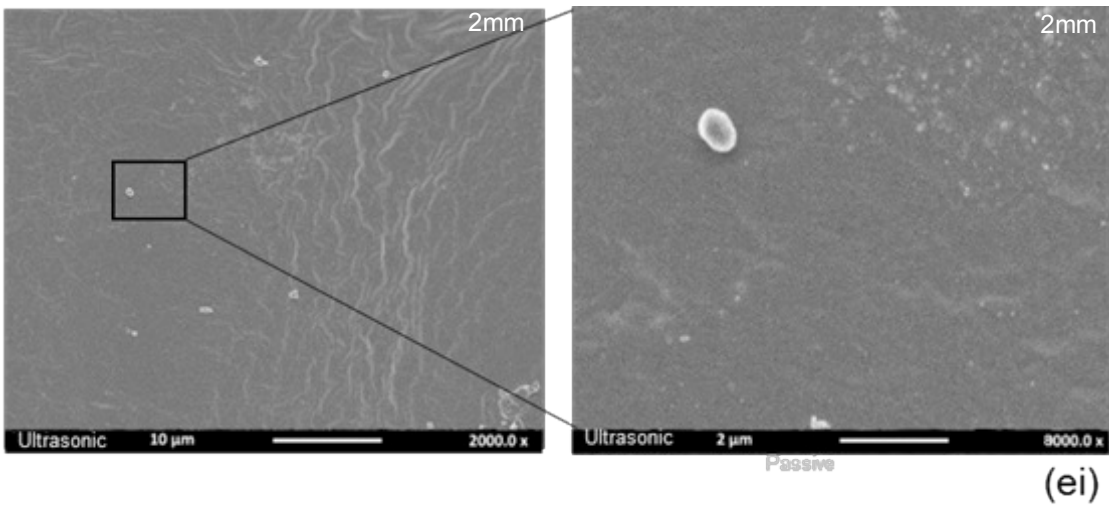
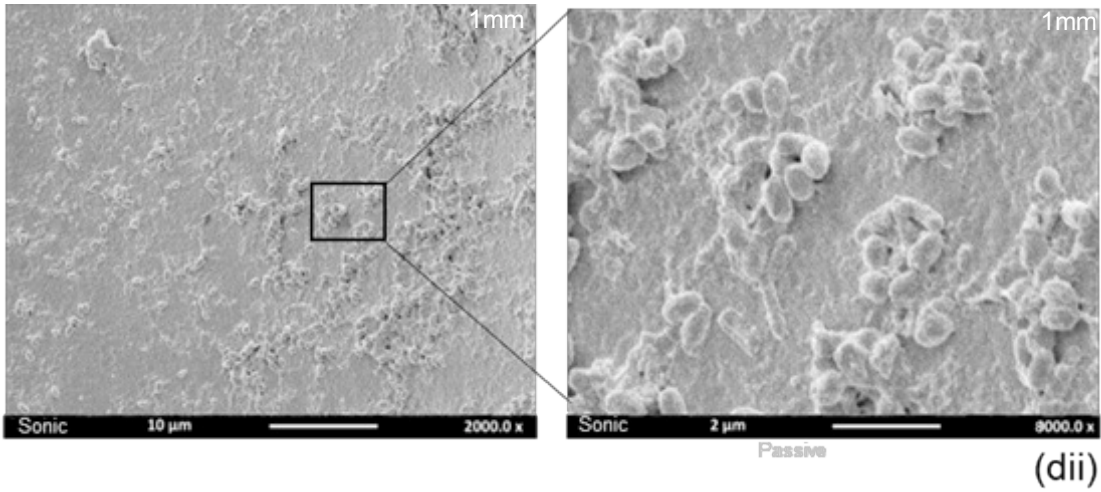

*The information at the upper right of each image indicates the level of the root canal (in mm) from the canal terminus where the residual biofilm was captured.

Legend

Figure 1: Image illustrates the design of the complex root canal mode (main and lateral canals. Each half of a simulated canal is of 18 mm length with 1.38 mm diameter at the coronal portion and 0.3 mm diameter at the apical portion. The lower view shows the printed two halves and when they are reassembled, a straight simple canal of 18 mm length, apical size 30, and a 0.06 taper is created with lateral canal of 3 mm length, 0.3 mm diameter.

Figure 2: Sketch illustrating the set-up of equipment for recording of the biofilm (biofilm was generated on the apical portion (3 mm) of the main and lateral (3 mm) canals model) removal by active or passive NaOCl irrigation protocol using a camera connected to a 2.5× lens of an inverted fluorescent microscope. The irrigant was delivered using a syringe with a 27-gauge side-cut open-ended needle, which was attached to a programmable precision syringe pump. The residual biofilm was quantified using computer software (Image-pro Plus 4.5).

Figure 3: Mean (95% CI) percentages values of the residual biofilm (%) covering the root lateral canal surface-area over duration (s) of syringe irrigation followed by passive or active irrigation protocols, stratified by type of irrigation (n = 10 per group).

Figure 4: SEM images illustrate (ai) *E. faecalis* biofilm grown for 10 days. (aii, aiii, and aiv) residual biofilm at 3 mm from the lateral canal after passive irrigation, manual, sonic protocols respectively. (b) Passive irrigation group; (i) residual biofilm at 2 mm from the lateral canal terminus; (ii) residual biofilm at 1 mm from the lateral canal terminus. (c) manual-agitation group; (i) residual biofilm at 2 mm from the lateral canal terminus; (ii) residual biofilm at 1 mm from the lateral canal terminus. (d) Sonic agitation group; (i) residual biofilm at 2 mm from the lateral canal terminus; (ii) residual biofilm at 1 mm from the lateral canal terminus. (e) Ultrasonic agitation group; (i) residual biofilm at 2 mm from the lateral canal terminus; (ii) residual biofilm at 1 mm from the lateral canal terminus.

Experimental groups	*Coefficient (±SE)	95% CI	<i>P</i> value
Manual agitation vs passive irrigation	10.78 (±5.9)	0.81, 22.36	0.068
Sonic agitation vs passive irrigation	21.04 (±5.9)	9.46, 32.63	0.001
Ultrasonic agitation vs passive irrigation	56.08 (±5.9)	44.49, 67.67	0.001
Manual agitation vs ultrasonic agitation	-66.88 (±5.9)	-78.46, -55.29	0.011
Sonic agitation vs ultrasonic agitation	-34.91 (±5.9)	-46.49, 23.33	0.011
Manual agitation vs sonic agitation	-32.31 (±8.1)	-43.89, 20.72	0.011

*Coefficient for the residual biofilm, SE= standard error, CI = Confidence interval.

Experimental groups	*Coefficient (±SE)	95% CI	<i>p</i> value
Manual agitation vs passive irrigation	-0.06 (±0.08)	-0.22, 0.09	0.428
Sonic agitation vs passive irrigation	-0.51(±0.08)	-0.66, 0.36	0.001
Ultrasonic agitation vs passive irrigation	-1.01 (±0.08)	-1.12, -0.85	0.001
Manual agitation vs ultrasonic agitation	0.07 (±0.08)	0.91, 1.22	0.001
Sonic agitation vs ultrasonic agitation	0.49 (±0.08)	0.34, 0.65	0.001
Sonic agitation vs manual agitation	0.58 (±0.08)	0.43, 0.74	0.001

*Coefficient for time effect represents the rate of biofilm removal, SE= standard error, CI = Confidence interval.

Table 1: Generalized linear mixed model analysis to compare the difference in the amount of residual biofilms (%) covering the lateral canal surface following passive or active irrigation time with 2.5 % NaOCl irrigant (n = 10 per group).

Table 2: Generalized linear mixed model analysing the effect of time (seconds) on the amount of biofilm removed from the lateral canal surface of each experimental group (n = 10 per group).

- Al-Jadaa A, Paqué F, Attin T, Zehnder M (2009) Necrotic pulp tissue dissolution by passive ultrasonic irrigation in simulated accessory canals: impact of canal location and angulation. *International Endodontic Journal* **42**(1), 59-65.
- Al Shahrani M, DiVito E, Hughes CV, Nathanson D, Huang GT-J (2014) Enhanced Removal of Enterococcus faecalis Biofilms in the Root Canal Using Sodium Hypochlorite Plus Photon-Induced Photoacoustic Streaming: An In Vitro Study. *Photomedicine and Laser Surgery* **32**(5), 260-266.
- Ballal NV, Kandian S, Mala K, Bhat KS, Acharya S (2009) Comparison of the efficacy of maleic acid and ethylenediaminetetraacetic acid in smear layer removal from instrumented human root canal: a scanning electron microscopic study. *Journal of Endodontics* **35**(11), 1573-1576.
- Boutsioukis C, Lambrianidis T, Kastrinakis E, Bekiaroglou P (2007) Measurement of pressure and flow rates during irrigation of a root canal ex vivo with three endodontic needles. *International Endodontic Journal* **40**(7), 504-513.
- Boutsioukis C, Verhaagen B, Versluis M, Kastrinakis E, van der Sluis LW (2010) Irrigant flow in the root canal: experimental validation of an unsteady Computational Fluid Dynamics model using high-speed imaging. *International Endodontic Journal* **43**(5), 393-403.
- Bronnec F, Bouillaguet S, Machtou P (2010) Ex vivo assessment of irrigant penetration and renewal during the final irrigation regimen. *International Endodontic Journal* **43**(8), 663-672.
- Castelo-Baz P, Martín-Biedma B, Cantatore G *et al.* (2012) In vitro comparison of passive and continuous ultrasonic irrigation in simulated lateral canals of extracted teeth. *Journal of Endodontics* **38**(5), 688-691.
- Cecic PA, Peters DD, Grower MF (1984) The comparative efficiency of final endodontic cleansing procedures in removing a radioactive albumin from root canal systems. *Oral Surgery, Oral Medicine, Oral Pathology* **58**(3), 336-342.
- Cunningham WT, Martin H, Forrest WR (1982) Evaluation of root canal debridement by the endosonic ultrasonic synergistic system. *Oral Surgery, Oral Medicine, Oral Pathology* **53**(4), 401-404.
- Dammaschke T, Witt M, Ott K, Schäfer E (2004) Scanning electron microscopic investigation of incidence, location, and size of accessory foramina in primary and permanent molars. *Quintessence International* **35**(9).
- De-Deus G, Brandão M, Fidel R, Fidel S (2007) The sealing ability of GuttaFlow™ in oval-shaped canals: an ex vivo study using a polymicrobial leakage model. *International Endodontic Journal* **40**(10), 794-799.
- de Gregorio C, Estevez R, Cisneros R, Heilborn C, Cohenca N (2009) Effect of EDTA, Sonic, and Ultrasonic Activation on the Penetration of Sodium Hypochlorite into Simulated Lateral Canals: An In Vitro Study. *Journal of Endodontics* **35**(6), 891-895.
- Druittman A, Stock C (1989) An in vitro comparison of ultrasonic and conventional methods of irrigant replacement. *International Endodontic Journal* **22**(4), 174-178.

- Halford A, Ohl C-D, Azarpazhooh A, Basrani B, Friedman S, Kishen A (2012) Synergistic Effect of Microbubble Emulsion and Sonic or Ultrasonic Agitation on Endodontic Biofilm in Vitro. *Journal of Endodontics* **38**(11), 1530-1534.
- Hartmann DP, Wood DD (1990) Observational methods. *International handbook of behavior modification and therapy*, 2 edn; pp. 107-138. Plenum Press, New York: Springer/USA.
- Hegde J, Bassetty K, Krishnakumar UG (2012) Quantity of sodium thiosulfate required to neutralize various concentrations of sodium hypochlorite. *Asian Journal of Pharmaceutical and Health Sciences* **2**(3), 390-393.
- Hsieh Y, Gau C, Kung Wu S, Shen E, Hsu P, Fu E (2007) Dynamic recording of irrigating fluid distribution in root canals using thermal image analysis. *International Endodontic Journal* **40**(1), 11-17.
- Huang TY, Gulabivala K, Ng YL (2008) A bio-molecular film ex-vivo model to evaluate the influence of canal dimensions and irrigation variables on the efficacy of irrigation. *International Endodontic Journal* **41**(1), 60-71.
- Izano EA, Wang H, Raganath C, Ramasubbu N, Kaplan JB (2007) Detachment and killing of Aggregatibacter actinomycetemcomitans biofilms by dispersin B and SDS. *Journal of Dental Research* **86**(7), 618-622.
- Jiang L-M, Lak B, Eijsvogels LM, Wesselink P, van der Sluis LW (2012) Comparison of the cleaning efficacy of different final irrigation techniques. *Journal of Endodontics* **38**(6), 838-841.
- Khademi A, Yazdizadeh M, Feizianfard M (2006) Determination of the minimum instrumentation size for penetration of irrigants to the apical third of root canal systems. *Journal of Endodontics* **32**(5), 417-420.
- Klausen M, Heydorn A, Ragas P *et al.* (2003) Biofilm formation by Pseudomonas aeruginosa wild type, flagella and type IV pili mutants. *Molecular Microbiology* **48**(6), 1511-1524.
- Koppe T, Meyer G, Alt K (2009) Comparative dental morphology. Preface. *Frontiers of Oral Biology* **13**, XI.
- Layton G, Wu W-I, Selvaganapathy PR, Friedman S, Kishen A (2015) Fluid Dynamics and Biofilm Removal Generated by Syringe-delivered and 2 Ultrasonic-assisted Irrigation Methods: A Novel Experimental Approach. *Journal of Endodontics* **41**(6), 884-889.
- Macedo R, Robinson J, Verhaagen B *et al.* (2014) A novel methodology providing insights into removal of biofilm-mimicking hydrogel from lateral morphological features of the root canal during irrigation procedures. *International Endodontic Journal* **47**(11), 1040-1051.
- McGill S, Gulabivala K, Mordan N, Ng YL (2008) The efficacy of dynamic irrigation using a commercially available system (RinsEndo®) determined by removal of a collagen 'bio-molecular film' from an ex vivo model. *International Endodontic Journal* **41**(7), 602-608.
- Mohammed SA, Vianna ME, Penny MR, Hilton ST, Mordan N, Knowles JC (2016) A novel experimental approach to investigate the effect of different agitation methods using sodium hypochlorite as an irrigant on the rate of bacterial biofilm removal from the wall of a simulated root canal model. *Dental Materials* **32**(10), 1289-1300.
- Moorer W, Wesselink P (1982) Factors promoting the tissue dissolving capability of sodium hypochlorite. *International Endodontic Journal* **15**(4), 187-196.
- Nair P, Henry S, Cano V, Vera J (2005) Microbial status of apical root canal system of human mandibular first molars with primary apical periodontitis after "one-visit" endodontic treatment. *Oral Surgery, Oral Medicine, Oral Pathology, Oral Radiology, and Endodontology* **99**(2), 231-252.
- Park E, Shen Y, Khakpour M, Haapasalo M (2013) Apical pressure and extent of irrigant flow beyond the needle tip during positive-pressure irrigation in an in vitro root canal model. *Journal of Endodontics* **39**(4), 511-515.
- Peters LB, Wesselink PR, Buijs JF, van Winkelhoff AJ (2001) Viable Bacteria in Root Dentinal Tubules of Teeth with Apical Periodontitis. *Journal of Endodontics* **27**(2), 76-81.
- Precautions MSB, Flush AC (2008) Guideline for Disinfection and Sterilization in Healthcare Facilities, 2008. [WWW document]. http://www.cdc.gov/hicpac/pdf/guidelines/Disinfection-Nov_2008.pdf URL [accessed on 08.07.2015].
- Renslow RS, Majors PD, McLean JS, Fredrickson JK, Ahmed B, Beyenal H (2010) In situ effective diffusion coefficient profiles in live biofilms using pulsed-field gradient nuclear magnetic resonance. *Biotechnology and Bioengineering* **106**(6), 928-937.
- Ricucci D, Siqueira JF, Bate AL, Ford TRP (2009) Histologic investigation of root canal-treated teeth with apical periodontitis: a retrospective study from twenty-four patients. *Journal of Endodontics* **35**(4), 493-502.

- Roberts AP, Mullany P (2010) Oral biofilms: a reservoir of transferable, bacterial, antimicrobial resistance. *Expert Review of Anti-Infective Therapy* **8**(12), 1441-1450.
- Ruddle CJ (2007) Hydrodynamic disinfection. *Dentistry Today* **11**(4), 1-9.
- Sabins RA, Johnson JD, Hellstein JW (2003) A comparison of the cleaning efficacy of short-term sonic and ultrasonic passive irrigation after hand instrumentation in molar root canals. *Journal of Endodontics* **29**(10), 674-678.
- Salzgeber RM, Brilliant JD (1977) An in vivo evaluation of the penetration of an irrigating solution in root canals. *Journal of Endodontics* **3**(10), 394-398.
- Shen Y, Gao Y, Qian W *et al.* (2010) Three-dimensional numeric simulation of root canal irrigant flow with different irrigation needles. *Journal of Endodontics* **36**(5), 884-889.
- Siqueira JF, Rôças IN, Lopes HP (2002) Patterns of microbial colonization in primary root canal infections. *Oral Surgery, Oral Medicine, Oral Pathology, Oral Radiology, and Endodontology* **93**(2), 174-178.
- Sjögren U, Figdor D, Persson S, Sundqvist G (1997) Influence of infection at the time of root filling on the outcome of endodontic treatment of teeth with apical periodontitis. *International Endodontic Journal* **30**(5), 297-306.
- Stojcic S, Shen Y, Haapasalo M (2013) Effect of the source of biofilm bacteria, level of biofilm maturation, and type of disinfecting agent on the susceptibility of biofilm bacteria to antibacterial agents. *Journal of Endodontics* **39**(4), 473-477.
- Van der Sluis L, Wu MK, Wesselink P (2005) The efficacy of ultrasonic irrigation to remove artificially placed dentine debris from human root canals prepared using instruments of varying taper. *International Endodontic Journal* **38**(10), 764-768.
- van der Sluis LW, Vogels MP, Verhaagen B, Macedo R, Wesselink PR (2010) Study on the influence of refreshment/activation cycles and irrigants on mechanical cleaning efficiency during ultrasonic activation of the irrigant. *Journal of Endodontics* **36**(4), 737-740.
- Verhaagen B, Boutsoukis C, Heijnen G, Van der Sluis L, Versluis M (2012) Role of the confinement of a root canal on jet impingement during endodontic irrigation. *Experiments in fluids* **53**(6), 1841-1853.
- Verhaagen B, Boutsoukis C, Sleutel C, Kastrinakis E, Van der Sluis L, Versluis M (2014) Irrigant transport into dental microchannels. *Microfluidics and nanofluidics* **16**(6), 1165-1177.
- Wang Y, da Silva Domingues JF, Subbiahdoss G, van der Mei HC, Busscher HJ, Libera M (2014) Conditions of lateral surface confinement that promote tissue-cell integration and inhibit biofilm growth. *Biomaterials* **35**(21), 5446-5452.
- Wang Z, Shen Y, Haapasalo M (2012) Effectiveness of endodontic disinfecting solutions against young and old *Enterococcus faecalis* biofilms in dentin canals. *Journal of Endodontics* **38**(10), 1376-1379.