

**ESSAYS IN ECONOMIC THEORY**

MANZUR RASHID

UCL

DOCTOR OF PHILOSOPHY

## DECLARATION

I, Manzur Rashid confirm that the work presented in this thesis is my own. Where information has been derived from other sources, I confirm that this has been indicated in the thesis.

M. Rashid

## ABSTRACT

This thesis has two major themes.

The first theme (Chapters 1 – 3) focuses on search theory and industrial organisation. I build a novel model of costly search where firms choose price distributions, draws are then taken from these distributions and the collection of draws is presented to consumers. Consumers are aware of the set of prices that firms charge but do not know which price is associated with which firm. As they search, they learn and update their beliefs about the prices offered by the other firms. I extend the model by introducing a price comparison website as well as informed and uninformed consumers. Equilibrium in the model has certain desirable properties.

The second theme (Chapters 4 – 6) focuses on game theory, and in particular, games with forgetful players. One of the 'conclusions' of the *Games and Economics Behaviour* collection of papers on imperfect recall is that there is no one way to model imperfect recall in games; in particular, modelling issues which are of little or no consequence in games of perfect recall suddenly become substantive in games of imperfect recall. Furthermore, there is little consensus on how to proceed. I introduce a class of decision problems where, if we think of forgetting in a novel but intuitive way, we can transform the game into a game of perfect recall – thus resolving the modelling ambiguities. I extend the model to show that an agent with self-control problems may in certain cases be better off having a bad memory. I consider whether a firm can offer different contracts to discriminate between different types of consumer with varying degrees of memory and sophistication. Finally, I consider the consumption behaviour of a forgetful consumer.

## TABLE OF CONTENTS

CHAPTER 1: BERTRAND COMPETITION WITH COSTLY SEARCH AND THE DIAMOND PARADOX.....	5
CHAPTER 2: INTRODUCING A PRICE COMPARISON WEBSITE.....	56
CHAPTER 3: COMMISSION FEES AND EXTENSIONS.....	91
CHAPTER 4: IMPERFECT RECALL AND TASK COMPLETION I.....	125
CHAPTER 5: IMPERFECT RECALL AND TASK COMPLETION II.....	156
CHAPTER 6: A SIMPLE CONSUMPTION PROBLEM WITH MEMORY IMPERFECTIONS.....	186
REFERENCES.....	221

# CHAPTER 1: BERTRAND COMPETITION WITH COSTLY SEARCH AND THE DIAMOND PARADOX

## 1 INTRODUCTION

It was perhaps George Stigler who first considered that consumers searching for a low price for a good (Stigler, 1961) or workers searching for a job (Stigler, 1962) were significant problems which warranted economists' attention. Since then, search theory has become an area of economic theory in its own right. The insights gleaned from its application include helping us to understand how price dispersion can occur for homogenous goods (e.g. Burdett and Judd, 1983) as well as why there might be involuntary unemployment in the labour market (e.g. Mortensen and Pissarides, 1994).

It is well known that when a consumer is engaging in costly search for some characteristic of a good such as a low price or high quality from a known distribution, optimal search involves the consumer following a cut-off rule (see for example Rothschild, 1974). That is, the consumer continues to search until he finds a price below (or a quality above) some threshold value, at which point he stops searching and purchases the item. Diamond's (1971) counterintuitive result, that under certain conditions, firms, when faced with such consumers will choose to offer the monopoly price no matter how small the search cost, is known as the *Diamond paradox* in the literature.

The intuition behind the result is elegant: consider that you are the owner of a firm contemplating what price to offer. Suppose that both firms and consumers know the distribution of prices in the marketplace, but not which price is being offered by which firm. In particular, you know that the lowest price being offered by any of the other firms is  $p$ . You reason that if you are visited by a consumer who incurs a search cost  $\epsilon$  every time he visits a

store, then he will certainly purchase from you if you charge a price of  $p + \epsilon$  (so long as this is below his reservation price). This is because the cheapest price being offered in the market is  $p$  and the consumer will have to pay a search cost at least equal to  $\epsilon$  in order to find this price. All firms reason like this and therefore no firm offers a price less than  $p + \epsilon$ . Now, each firm realises that if a consumer visits his store, he will purchase for sure at a price of  $p + 2\epsilon$  (so long as this is below his reservation price). Iterating this process causes the price to increase to the monopoly price. Furthermore, a firm has no incentive to offer a lower price than his competitors. This is because consumers who are currently visiting other stores, reason that the probability of actually visiting your store (if they decide to search) is so low that their decision to search is independent of the pricing decision of any single firm. We will come back to these ideas in more detail later.

In this chapter I introduce a novel model of search where firms choose price distributions from which draws are taken. The full set of draws is presented to the consumers, but the consumers are not told which price is associated with which store. In order to find out, they must engage in costly search. We know from Diamond (1971) that while it is the case that zero search costs can lead to Bertrand competition and push prices down to marginal cost, even small search costs can weaken competitive pressures substantially and lead to monopoly pricing. In our model, the equilibria are not so stark. In particular, we will see that for small search costs, equilibrium prices are close to competitive prices. Higher search costs are associated with higher expected prices and greater price dispersion.

The literature on search is substantial and I do not intend to review it thoroughly here. What I want to stress however is that in the typical search literature, when a consumer decides to search, they are essentially paying a search cost in order to take a draw from some typically known distribution. When the decision is made as to whether to undertake an additional search, they do not (at that time) know the realisation of the draw that will result from undertaking the search. In the model presented here things are somewhat different. At the time of deciding whether to undertake an additional search, instead of having knowledge of the distributions that

firms are using to randomise their prices, consumers actually know the realisation of these draws, although they do not know which price is associated with which store. This is an important distinction since it leads to the possibility of a much sharper analysis when the number of firms is not large. When the number of firms is large, there is not a substantial difference in the two different modelling strategies; one can see this clearly when there are infinite firms: infinite ‘realised’ draws from a continuous price distribution will lead to the consumer facing a continuous price distribution from which to take a costly draw from. At the other end of the spectrum, consider the case of only two firms, if the two draws are taken and presented to the consumer, then just by visiting one store the consumer is able to reveal all relevant price information and is then given a stark choice: purchase at the current store or, if you pay a search cost, you can purchase at the other price that you now know for sure. There is no ambiguity here, if the decision maker (DM) decides to search he know exactly what he is going to get. This is going to make the consumer’s decision rule relatively simple when there are a small number of firms.

We justify such a modelling strategy by considering that a consumer, when searching among a limited number of firms, is much more likely to know that there are certain particular prices being charged in the marketplace, rather than to know the cumulative distribution function (CDF) firms are using to randomise their prices. The consumer could gain this knowledge, for example, from partial recall of advertisements: ‘I know I saw an advert somewhere for this item being sold at £9.99 but I can’t remember the firm which was offering that price;’ or word of mouth from acquaintances and friends: ‘My friend Catherine bought one of these recently for £15 but she didn’t tell me from where;’ or even partial recall from previous visits to the marketplace when other goods were purchased: ‘Sometimes I do my grocery shopping at Asda and sometimes at Tesco, I know I have seen mangos priced at £1.50 at one of these stores but at which store eludes me.’ Of course as we have noted, as the number of firms becomes large, knowing the realisation of prices and knowing the full CDF become equivalent, but for a small number of firms it is much more reasonable and much less computationally demanding to

expect the consumer to know that if she searches, she will find a price which is a draw from some finite set of known discrete prices.

## 1.1 RELATIONSHIP TO THE LITERATURE

For a concise review of the substantial literature on search it is hard to do better than read the reviews by Diamond (1987) and Shi (2008). Diamond reviews what might be called *classical search theory* including laying out the argument behind the optimality of a consumer sequentially searching for a low price from a known distribution to follow a cut-off rule. Shi (2008) surveys the more recent innovations in the literature including directed or competitive search as found in Peters (1991). The substantive difference between directed and undirected search is that in the later, pricing decisions by firms have no impact on matching frequencies, so that for example a firm offering a low price for a good or a high wage for a job is not more likely to be sampled or matched to a consumer or a worker than a firm offering a high price or a low wage. Unsurprisingly, in directed search models, competitive pressures are stronger since there is a greater incentive to make attractive offers. Our model has more in common with the classical undirected literature as the consumers in our model are assumed to be completely ignorant of *which* firm offers *which* price and therefore search randomly even though they are perfectly informed about the realisation of prices in the market.

The standard intuition in industrial organisation is that the more firms there are competing in a market, the closer that market is to the perfectly competitive paradigm of marginal cost pricing. A number of papers (e.g. Eliaz and Spiegler, 2006; Spiegler, 2006) have found that in certain circumstances the reverse can be true, that is, more firms can weaken competitive pressures and indeed this is what we find in our paper. The basic intuition in our paper is that the more firms there are, the less able a firm is to attract consumers by offering a low price. This is because the consumer finds it difficult to find the low-price firm, thus the low-price is 'hidden' amongst the large amount of other prices being offered.



There is distinction in the literature between those models where a consumer is searching for a low price for a homogenous product (e.g. Baye and Morgan, 2001) and those papers which introduce some heterogeneity into the characteristics of the good as well as consumers' preferences. In the latter, consumers are searching simultaneously for a low-price product and one which matches well with their tastes (e.g. Chen and He, 2011). Our paper is of the first kind, there is no heterogeneity, either in the good being sold nor in consumers' preferences. In the former models, pure-strategy equilibria often do not exist and indeed in many of the cases we look at (but not all) we find the same.

Since our model can be thought of as a model of Bertrand competition with search costs we should mention the classic literature on Bertrand competition. Bertrand (1883) provides an alternative to Cournot (1838), who models a duopoly where firms compete by choosing quantities and then sell all their output at the price which clears the market. In Bertrand competition, firms compete instead by choosing prices which typically leads to much sharper competition since firms undercut one another until marginal cost pricing results.<sup>1</sup> Edgeworth (1925) showed that if firms were capacity constrained then marginal cost pricing may no longer be optimal. A nice result by Kreps and Scheinkman (1983) showed that under certain conditions, a two-stage game where firms first choose capacities and then engage in Bertrand competition gives rise to the same equilibrium prices as those in Cournot competition. Baye and Morgan (1999) show that in standard Bertrand competition, if firms' profits functions are unbounded then there exist mixed strategy equilibria where firms earn positive profits.

## 1.2 THE EDGEWORTH CYCLE

Edgeworth's (1925) contribution and the literature which followed are particularly relevant for our purposes and inform the way we have structured our analysis in the first three chapters. His idea is that in Bertrand competition, marginal cost pricing is only an equilibrium if firms are able to single-handedly satisfy the market demand which results at that price. If they are not, then it

---

<sup>1</sup> In Bertrand's original paper, he failed to see that firms will stop undercutting one another once the price has reached the marginal cost and instead thought that the process would continue without end.

is no longer a best-response to offer marginal-cost pricing when your competitor offers marginal-cost pricing. This is because strictly positive profits can now be gained by offering a price higher than marginal cost. How so? Well, consumers will first try to satisfy their demand by going to the firm offering marginal-cost pricing. However, once that firm has sold its entire capacity, consumers find that they cannot buy as much quantity as they would like. The only way of buying further units of the good is by going to the second (higher-priced) firm. This allows the second firm to sell to some consumers at a price greater than marginal cost and make strictly positive profits. However, this situation cannot be an equilibrium since the firm which is making zero-profit by offering marginal-cost pricing has an incentive to raise his price. So long as the price he offers is less than his competitor's price, consumers will try to satisfy their demand by visiting his firm first. This means he will prefer to just undercut his competitor. His competitor reasons in the same way and also wishes to undercut. They proceed to undercut one another until one firm reasons that he is better off switching to a high price and selling to those consumers who were unable to satisfy their demands by visiting his lower-priced competitor. In his own words, Edgeworth states:

*'At every stage...it is competent to each monopolist to deliberate whether it will pay him better to lower his price against his rival as already described, or rather to raise it to a higher...for that remainder of customers of which he cannot be deprived by his rival. ... Long before the lowest point has been reached, that alternative will have become more advantageous than the course first described.'* (1925, p.120)

Firms' resulting behaviour exhibits 'cycles', that is, they engage in undercutting one another until the price 'jumps'. The two firms then undercut one another again and so on. The reason this is interesting for our purposes is that, as we shall see, in our models, when firms are restricted to pure strategies (as in Edgeworth's original analysis) there will often not exist pure-strategy equilibria and furthermore, the dynamic behaviour of firms will exhibit cycles similar to Edgeworth cycles. Edgeworth's model gave rise to what became called in the literature *Edgeworth-Bertrand competition*, where firms compete on price; however, no one firm can supply the entire market. Some papers in this vein include Beckman (1965) and Levitan and Shubik

(1972) who show that while there are no pure-strategy equilibria, for some range of capacities, there will exist mixed strategy equilibria. Indeed, we will often find the same in our model. There are similarities and differences between our model and Edgeworth-Bertrand competition. The key similarity is that when firms are contemplating pricing decisions they encounter two opposing forces. On the one hand, they typically like to be cheaper than their competitor, as this means they are likely to sell to more consumers (this is true in standard Bertrand competition). On the other hand, they don't mind being more expensive than their competitor, so long as not too many consumers desert them (this is not true in Bertrand competition). It is these opposing forces which lead to the cycles. The cycles can be seen most clearly in our model when we restrict firms to playing only pure strategies and the strategy space is discrete. For this reason we often follow the following structure in our analysis:

- (i) We consider the game when firms are restricted to pure-strategies and the action space is continuous (this typically allows us to show that there will be no pure-strategy Nash equilibria).
- (ii) We consider the game when firms are restricted to pure-strategies and the action space is discrete (this allows us to analyse the cycles in prices which result from the tension firms face between on the one hand, wanting to undercut their competitor, and on the other, charging a high price).
- (iii) We consider the game when firms are able to play mixed-strategies and the action space is continuous (this allows us to find and characterise mixed-strategy Nash equilibria).

A key difference between the models presented here and Bertrand-Edgeworth competition is that in our model, although a firm can be more expensive than its competitor and still attract customers, it cannot be too expensive. That is, the value of the search cost puts an upper-bound on how much more expensive a firm can be compared to its competitor and still hope to attract consumers. Whereas in Bertrand-Edgeworth competition, a firm could offer the monopoly price while his competitor offered the competitive price and still sell to some consumers.

For reasons which will become clear later in the chapter, talking about Edgeworth cycles only makes sense in a game where we restrict attention to the case where firms can only offer pure-strategies and their action space is discrete rather than continuous. This is because in the continuous action game, a firm's pure best-response to his opponent's pure-action will often not be well-defined. In order to analyse the price cycles which result in the models, I refer to what I call the *pure strategy dynamics* of the game. What I mean by this is the following: suppose that firm  $j$  chooses the price  $p_j$ , I consider what firm  $i$ 's best-response to this is,  $BR_i(p_j)$ . Next, I consider how firm  $j$  would best-respond if firm  $i$  offered the price  $BR_i(p_j)$  i.e.  $BR_j(BR_i(p_j))$ . We repeat this process indefinitely giving us an infinite chain of responses  $\{p_j, BR_i(p_j), BR_j(BR_i(p_j)), \dots\}$ . This idea, a simple version of what is sometimes called *fictitious play* (see for example Brown (1951), Fudenberg and Levine (1998)), is something which has been analysed in the literature, and in particular in the literature of learning in games. One nice feature of analysing the fictitious play of a game is that it can converge to Nash equilibria; however it will only do so in a certain class of games (see Hofbauer and Sandholm (2002)). There are plenty of games in which fictitious play does not converge to Nash equilibria (e.g. see Shapley (1964)) and indeed typically this will be true in our models. The benefits of looking at the pure strategy dynamics for our purposes are two-fold:

- (i) It tells us how firms might behave in a hypothetical dynamic-game where they have to change prices regularly in response to one another, and
- (ii) There is an intimate link between the pure strategy dynamics of a game and the set of rationalisable strategies.

For the avoidance of any ambiguity, we define here what we mean by rationalisable:

**Definition 1:** *In the game  $\Gamma$ , a strategy is rationalisable if it survives the iterated removal of strategies which are never a best response.*

We know from Bernheim (1984) and Pearce (1984) that an equivalent requirement for a strategy to be rationalisable is that one can create an infinite chain of justification for why a player might

play it.<sup>2</sup> When players can randomise, then clearly this infinite chain of justification can include mixed strategies. While if they are restricted to playing only pure strategies, then we require that the chain of justification only contains pure-strategies. Recall that the pure strategy dynamics will give us a chain of responses  $\{p_i, BR_i(p_i), BR_i(BR_i(p_i)), \dots\}$ . Now there are a number of possibilities as to how this chain will evolve. One possibility is that at some point, a pure-strategy Nash equilibrium is reached, that is  $\{\dots, a, b, a, b, \dots\}$ . Another possibility is that at some point in the chain there does not exist a best response, e.g.  $\{p_i, BR_i(p_i), BR_i(BR_i(p_i)), \emptyset\}$ , in which case the chain ends. A further possibility is that at some point in the chain, a repeating cycles occurs, e.g.  $\{\dots, a, b, c, d, a, b, c, d, a, \dots\}$ , if this is the case, we can say that in the game where firms are restricted to playing pure strategies, the strategies in the set  $\{a, b, c, d\}$  are rationalisable.

### 1.3 THE STRUCTURE OF THE CHAPTER

In section 2, we outline the general model for  $N$  firms and go through some simple examples. Next, we look at the case of only two firms, which can be considered as a model of Bertrand competition with search costs. We analyse optimal firm and consumer behaviour and attempt to find equilibria in both pure and mixed strategies. We look at the links between our model and Diamond's (1971) model and see under what conditions the *Diamond paradox*, that is, monopoly pricing, is an equilibrium in our model. We also consider the links between our model and Bertrand competition and argue that our model – with two firms – can be considered to be a generalisation of Bertrand competition.

We find that when firms are restricted to playing pure strategies and the strategy space is continuous, there do not exist any rationalisable strategies. When firms are restricted to pure strategies and the strategy space is discrete then there does not exist a Nash equilibrium but offering a discrete price in the interval  $[2\epsilon, 4\epsilon]$  is rationalisable. When firms can play mixed strategies and the strategy space is continuous there is a unique symmetric equilibrium which we

---

<sup>2</sup> For example, it would be reasonable for me to play the strategy  $s$  if it was a best response to my opponent playing  $s'$ , which in turn was a best response to me playing  $s''$ . Where  $s''$  is a best response for me to my opponent playing  $s^*$ , where  $s^*$  is a best response to me playing  $s$ . The infinite chain of justification being  $(s, s', s'', s^*, s, s', \dots)$ .

characterise. Next, we show that in our model for any finite number of firms  $N \geq 2$ , monopoly pricing is an equilibrium so long as search costs are sufficiently high. We characterise the minimum search cost required for monopoly pricing to be an equilibrium and show that this decreases as the number of firms increases. In the limit, as  $N \rightarrow \infty$ , any strictly positive search cost results in monopoly pricing. We then show that if firms are unable to commit to the prices that they offer then even two firms will result in monopoly pricing for any strictly positive search cost. Finally, we characterise the deadweight loss due to costly search.

## 2 THE MODEL

We begin by outlining the general  $N$ -firm search model. There is a unit mass of consumers searching for the lowest price for one unit of a good which they value at  $v = 1$ , they do not know the prices at any given store until they visit but they do know the *realised* distribution of prices before they decide whether to engage in search. Visiting a store incurs a search cost  $\epsilon$  for the consumer. Firms can produce the good costlessly. This is all common knowledge.

### *Timing of the game*

1.  $N$  firms simultaneously each choose a distribution  $F_i$  ( $i = 1, \dots, N$ ) from which their price will be drawn.
2. Nature draws a single price  $p_i$  from each distribution  $F_i$ .
3. The consumer is presented with the collection of prices  $(p^1, \dots, p^N)$  but does not know which price is associated with which store.
4. Consumers engage in costly search (or not).

In stage one, when we refer to firms playing pure strategies, we mean that the distributions that they choose  $F_i$  must be degenerate, thus they are just choosing a price to offer for sure. When we consider firms playing mixed strategies, the distributions that they choose,  $F_i$ , may be degenerate or they may be non-degenerate, in which case, they will be randomising over a set of prices. The reason for firms randomising are: (i) as we will see, there will typically not exist an equilibrium in pure strategies, and (ii) although consumers will know the realisation of firms'

randomisation before deciding whether to engage in search, firms, when deciding what distribution of prices to offer, will not. This means that firms cannot follow simple strategies which ensure that they will undercut their competitors e.g. choose a price just low enough to attract all the customers. Even in equilibrium – at the time they are called upon to choose their price distribution – they will not know the realisation of prices in the market, even though they will know what distributions other firms are using.

In the second stage, Nature takes a single draw from each distribution chosen by firms. Note that we include the player Nature in the description of the game for expositional purposes only; it is not necessary for the firms to choose their distributions and submit it to some third-party (which we call Nature) who then carries out the randomisation on the firms' behalf. The firms could just as easily carry out the randomisations themselves. One of the reasons that we do this is that in the third stage when the consumer is presented with the prices he cannot tell which firm generated which price. One can think of the role of Nature as being responsible for drawing the prices in the second stage and then destroying any possible information which might link the price being offered to the firm offering that price. For example, if the realised prices turn out to be  $(p_1, p_2, p_3)$  one might be concerned that if this was presented to the consumers, even with the subscripts removed, they could infer simply from the order of the prices, who was offering what price. One could imagine that Nature, on drawing  $(p_1, p_2, p_3)$ , randomly jumbles up the prices so that they are instead ordered  $(p_3, p_1, p_2)$ , removes the subscripts and then adds superscripts according to the new random order  $(p^1, p^2, p^3)$ . In any case, the point we are making is that Nature is not a necessary player in this model and there is an equivalent game without Nature where firms carry out their own randomisations (if they choose to randomise at all) and then post them on a noticeboard for consumers to view. When consumers view the noticeboard they learn the prices but not which firm is offering which price. The advantage of thinking in terms of a third-party is that it makes clear that the firm is not able to communicate directly with the consumers and so there is no possibility that the consumer may be able to identify who is offering that price without searching.

## 2.1 SIMPLE EXAMPLES

Here we consider three simple cases of our model to build our intuition for how it works. It turns out that in each of these cases the equilibrium is trivial; nonetheless it is instructive to see why.

*Example 1: When there is only one firm and consumers incur no search costs*

Since there is only one firm, nature only draws a single price from a single distribution and presents it to the consumer. This fully reveals all relevant information. The consumer has to then decide whether to visit the store. As he has no search costs, he is willing to visit the store if and only if the price offered is less than or equal to his valuation. Knowing this, the firm will choose a degenerate distribution at the monopoly price  $p = 1$ .

*Example 2: When there is one firm and consumers incur search costs*

Here, again nature will reveal all relevant information to the consumer. The firm similarly wishes to charge the highest price which is consistent with the consumer visiting his store. Since the consumer has to be compensated for his search cost, the firm will choose a degenerate distribution with  $p = 1 - \epsilon$ . Notice that there is a commitment issue here. It is important that the firm is able to commit to the price that he posts, otherwise, once the consumer incurs the search cost to visit the firm, it is now optimal for the firm to renege and offer the monopoly price  $p = 1$ . Knowing this, the consumer does not search and there is no trade. In the analysis which follows we consider that firms are committed to the prices which they post.

*Example 3: Two firms and no search costs*

Then our model is equivalent to Bertrand competition. Consumers will always purchase from the firm with the lowest price and if both firms choose the same price, the market is split equally. In equilibrium, firms will charge marginal cost, in this case  $p = 0$  and make zero profits.



The simplest non-trivial case is where there are two firms (which we call firm  $i$  and firm  $j$ ) and consumers who face strictly positive search costs. One might consider this a model of Bertrand competition with search costs.

### 3 THE TWO FIRM CASE WITH POSITIVE SEARCH COSTS

In this section I outline the model for the case of two firms, including, the extensive form of the game for a particular consumer drawn from the unit mass of consumers. Next, I consider optimal consumer behaviour when faced with the two realised prices. Consumer behaviour is considered first since, in the extensive form, they are called upon to act last and so backwards induction requires us to calculate how they would optimally act before considering optimal firm behaviour. Next, we consider optimal firm behaviour when firms are restricted to playing pure strategies. We show that the game has no pure strategy equilibrium. Then we allow firms to play mixed strategies and solve for the unique symmetric mixed strategy equilibrium.

Each firm begins by choosing a price distribution  $F$ . We assume that these distributions can be represented by right-continuous CDFs and that they only include prices in the interval  $[0, 1]$ . That is, they cannot price below their marginal cost or price above consumers' reservation price. Nature then draws a price from each distribution and presents the two prices  $(p_i, p_j)$  to the consumers – but not which price is associated with which store – who must decide now whether to search or not. If consumers do not search, both consumers and firms receive a payoff of zero. While if consumers do search, half go to firm  $i$  and the other half to firm  $j$ . Consumers learn the price at the store which they visit and update their beliefs about the probabilities of visiting the other stores if they undertake an additional search. In the two-firm case this is trivial since one search fully reveals all relevant information. Consumers then decide whether to purchase at the current store or incur the additional search cost to visit the other store. They could potentially end their search without purchasing, but it is easy to see that (once a consumer has revealed himself to be willing to undertake the initial search) he will always prefer to buy from one of the stores rather than end his search without making a purchase. If the purchase is made, the consumer receives a payoff equal to his valuation less the price he

paid and his search costs. The firm which makes the sale receives a payoff equal to their profit, which is simply their revenue as there are no costs.

### 3.1 THE EXTENSIVE FORM

There is a unit mass of consumers in our model but here we consider the extensive form of the game from the perspective of a *particular* consumer who we call player 1 and the two firms,  $i$  and  $j$ . The set of players is  $\{1, i, j\}$ . Firms must choose prices, or randomise over prices, in the interval  $[0, 1]$  so we have that their action sets are:  $A_i = A_j = [0, 1]$ . The strategy set of the consumers is best seen through the extensive form below. Firms are profit maximisers with payoff function for firm  $i$ :  $\pi_i(p_i) = p_i \cdot 1[\text{consumer buys from firm } i]$ , where  $1[\cdot]$  is the indicator function (similarly for firm  $j$ ).

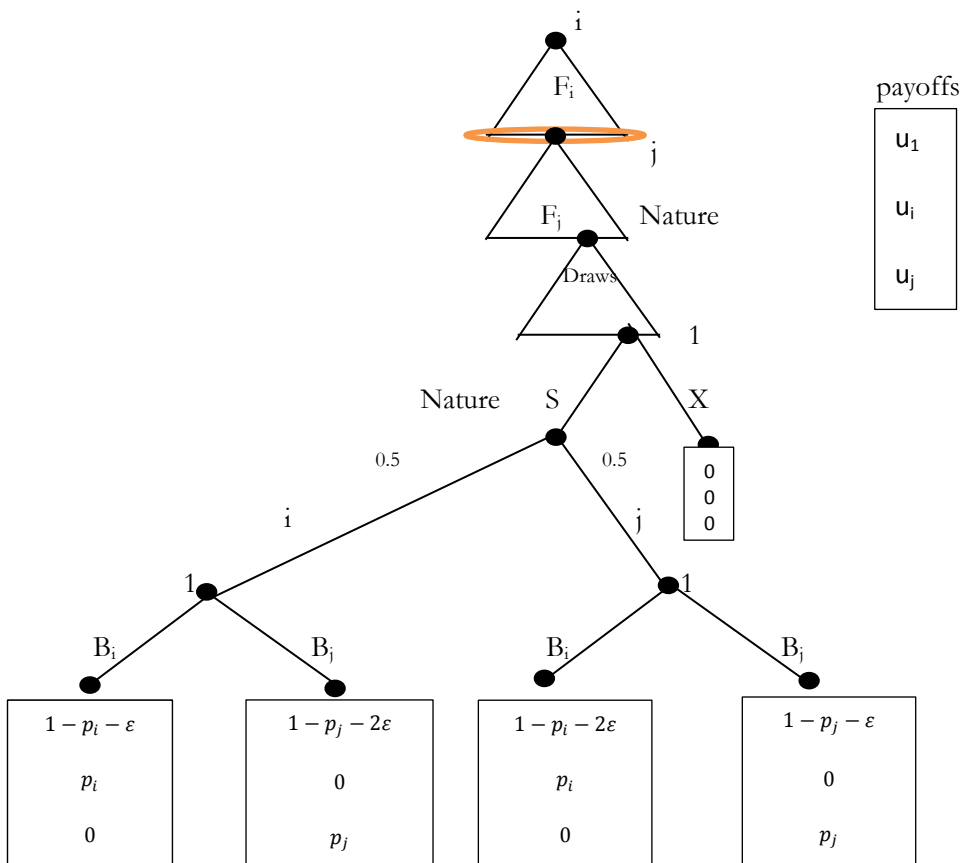

Figure 1: The extensive form of the two-firm case for a particular consumer.

Inspecting Figure 1, we see that initially firm  $i$  chooses its price distribution  $F_i$ . Next, without knowledge of firm  $i$ 's choice, firm  $j$  chooses its price distribution  $F_j$ . Nature then takes a single draw from each of these distributions and presents the two draws to the consumer (Player 1). The consumer can choose not to search, in which case everyone gets a payoff of zero, or he can choose to search. If he searches, Nature sends him to firm  $i$  or firm  $j$  with equal probability. Once the consumer is at one of the stores, the price at that store is revealed to him and he is able to infer the price at the other store. He now chooses which store to buy from. Clearly, purchasing from the other store incurs an additional search cost. The firm's payoff is equal to its price if the consumer chooses to buy from that particular firm and zero otherwise.

#### 4 OPTIMAL CONSUMER SEARCH BEHAVIOUR

Assuming the consumers wish to participate and that firms never charge more than consumers' valuation,<sup>3</sup> consumers should optimally buy at the first store they visit unless the price at the other store is more than  $\epsilon$  less than the price in the first store, in which case they should buy at the second store. This is because it will be worth incurring the additional search cost in order to benefit from the lower price. We know that as there are only two firms and the consumer knows  $(p_i, p_j)$  prior to searching, once he observes the price in the first store that he visits, he is able to infer the price at the other store perfectly. Thus, when there are two firms, one search is sufficient to fully reveal which store is associated with which price. Notice that the store which the consumer happens to visit first has an advantage over the other firm as it is not sufficient for the other firm to be cheaper to attract the consumer; it must be more than  $\epsilon$  cheaper. Since the consumer has no knowledge about which price is associated with which firm before searching, we assume that he is equally likely to visit either firm. In the context of a unit mass of consumers, half will go first to firm  $i$  and the other half to firm  $j$ .

In general, if there were  $N$  firms, consumers would receive a set of prices  $(p^1, \dots, p^N)$  and reason that if they choose to search they will have a  $1/N$  probability of visiting any particular store on

---

<sup>3</sup> If firms were to choose prices which meant that either consumers did not participate or were higher than their valuations they would make zero profits, we will see that in equilibrium firms will make positive profits.

their first search. On visiting the first store they would learn the price being offered there. They could either purchase at that price or continue their search from the remaining  $N - 1$  firms, now reasoning that they have a  $1/(N - 1)$  chance of visiting any particular store on their next visit and so on. A consumer would need to visit  $N - 1$  stores in order to learn exactly where each price was being offered.

## 5 OPTIMAL FIRM BEHAVIOUR

### 5.1 IN PURE STRATEGIES

Here we consider the case where the two firms are restricted to playing pure strategies. When firms are restricted to playing pure strategies the distributions they choose must be degenerate. We begin by considering firms' best responses and attempt to characterise the rationalisable strategies and go on to show that there does not exist an equilibrium in pure strategies. Considering firm  $i$ 's best response to a price offered by firm  $j$ : suppose firm  $j$  charges a price of  $p_j$ , the proportion of consumers that firm  $i$  attracts depends on how  $p_i$  compares to  $p_j$ . The diagram below shows what proportion of customers firm  $i$  attracts at different prices  $p_i$ :

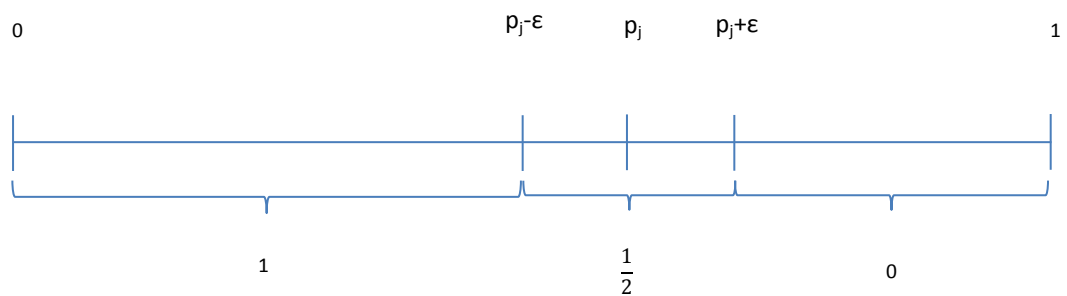

Figure 2: The proportion of consumers firm  $i$  attracts at different prices.

That is, if firm  $i$  prices in the interval  $[0, p_j - \epsilon)$  then it will sell to all of the consumers. This is because half of the consumers who initially visit firm  $i$  will purchase from it; the other half, who initially visit firm  $j$ , will consider that it is worth paying an additional search cost to purchase from firm  $i$ .

If firm  $i$  prices in the interval  $[p_j - \epsilon, p_j + \epsilon]$  then it will sell to half of the consumers. This is because, if the two prices are within  $\epsilon$  of one another, those consumers who initially visit firm  $i$  prefer to purchase from firm  $i$ , either because it is cheaper than firm  $j$ , or else, if it is more expensive, the search cost does not warrant visiting firm  $j$ . Similarly, the consumers who initially visit firm  $j$ , reason that it is not worth paying an additional search cost, and purchase from firm  $j$ . That is, when the two prices are closer than  $\epsilon$  apart, the consumer will always purchase from the firm he visits first, so long as the price being offered is below his reservation price.

If firm  $i$  prices in the interval  $(p_j + \epsilon, 1]$  it will sell to none of the consumers. This is because firm  $i$  is offering a price strictly more than firm  $j$ 's price plus a search cost, which will mean that all of the consumers who initially visit firm  $j$  will purchase from there, and all the consumers who initially visit firm  $i$  will be willing to pay the additional search cost to purchase at a price which is more than  $\epsilon$  cheaper.

This is similar in many ways to standard Bertrand competition, except that in Bertrand competition the region of prices where firm  $i$  attracts one-half of the consumers shrinks so that it only comprises one price, the price of the competitor,  $p_j$ . This makes sense because Bertrand competition is a special case of our model, the case when  $\epsilon = 0$ . Indeed, plugging  $\epsilon = 0$  into the three regions above gives us that firm  $i$  will attract all of the consumers if its price is in the interval  $[0, p_j)$ ; half of the consumers if its price is  $p_j$ ; and none of the consumers if its price is in the interval  $(p_j, 1]$ . This is precisely the same as Bertrand competition.

Clearly in our model it will never be a best response to offer a price more than  $\epsilon$  greater than  $p_j$  since – in a similar way to offering a price higher than your competitor in Bertrand – this will result in zero profits. If  $p_i$  is within  $\epsilon$  of  $p_j$ , both firms will receive half of the consumers, thus  $p_i = p_j + \epsilon$  does strictly better than all other prices in the interval  $[p_j - \epsilon, p_j + \epsilon]$ . As for offering a price in the region  $[0, p_j - \epsilon)$ , things are complicated somewhat by the fact that whatever price firm  $i$  chooses in this interval, there is some other slightly higher price which yields him strictly higher profits. A similar thing happens in Bertrand competition when firm  $j$  offers a price  $p_j$  strictly greater than marginal cost, there is no price that firm  $i$  can offer which is a best response

to  $p_j$ . The reason for this is that  $p_i > p_j$  cannot be a best response since firm  $i$  receives zero profits, while offering  $p_i = p_j$  yields strictly positive profits. However  $p_i = p_j$  also cannot be a best response since offering a price a very small amount below  $p_j$  will allow firm  $i$  to take the entire market and this must do better than matching firm  $j$ 's price. So, if there is to be a best response to  $p_j$  it must be some price  $p_i < p_j$ , however whatever price firm  $i$  picks such that  $p_i < p_j$  there is always some other price in the interval  $(p_i, p_j)$  which does strictly better. Thus, in Bertrand competition, the set of best responses to firm  $j$  offering a price strictly greater than marginal cost is the empty set. In a similar way, in our model there cannot be a best response in the interval  $[0, p_j - \varepsilon)$ . This leaves firm  $i$  with two possible candidates for a best response to  $p_j$ :<sup>4</sup>

1.  $p_i = p_j + \varepsilon$ . Which we call 'exploit' i.e. the highest price which retains half of the consumers.
2.  $\emptyset$ , the empty set i.e. no best response.

To work out when the set of best responses is going to be empty, we consider that firm  $i$  offering a price arbitrarily less than  $p_j - \varepsilon$  will be able to sell to all the consumers and will yield a profit arbitrarily close to, but less than,  $p_j - \varepsilon$ . We will call this strategy 'undercut'. Associated profits are then:

$$(E)xploit: \pi_i(E) = \frac{1}{2}(p_j + \varepsilon)$$

$$(U)ndercut: \pi_i(U) \approx p_j - \varepsilon$$

Comparing profits it turns out that firm  $i$  prefers to play U for prices  $p_j > 3\varepsilon$ , and E for prices less than or equal to  $3\varepsilon$ . This gives us  $i$ 's best response function:

$$BR_i(p_j) = \begin{cases} \emptyset, & p_j > 3\varepsilon \\ p_j + \varepsilon, & p_j \leq 3\varepsilon \end{cases}$$

---

<sup>4</sup> Assuming that  $p_j + \varepsilon \leq 1$ .

That is to say, for  $p_j \leq 3\varepsilon$ , firm  $i$ 's best response is to offer a price  $\varepsilon$  greater, while for  $p_j > 3\varepsilon$ , there does not exist a best response, although, we are able to say that there exists some price in the interval  $[0, p_j - \varepsilon)$  which yields strictly greater profits than  $\pi_i(E) = \frac{1}{2}(p_j + \varepsilon)$ .

**Result 1:** *When firms are restricted to pure strategies and can offer any price in the interval  $[0, 1]$  the set of rationalisable strategies is the empty set  $\emptyset$ .*

**Proof:** The set of rationalisable pure strategies are those which remain after the iterative deletion of strategies which are never a best response. Beginning with allowing players to price anywhere in the interval  $[0, 1]$ , consider that the best responses to those prices in the interval  $[0, 3\varepsilon]$  are the prices in the interval  $[\varepsilon, 4\varepsilon]$  while for the prices in the intervals  $(3\varepsilon, 1]$  there is no best response. Thus we are able to delete those prices in the intervals  $[0, \varepsilon)$  and  $(4\varepsilon, 1]$  since they are never a best response to any price in the interval  $[0, 1]$ . We now iterate, so that the prices in the interval  $[\varepsilon, 3\varepsilon]$  have best responses in the interval  $[2\varepsilon, 4\varepsilon]$ , while the prices in the interval  $(3\varepsilon, 4\varepsilon]$  have no best response. Thus, we are able to delete those prices in the intervals  $[\varepsilon, 2\varepsilon)$  since they are never a best response to any price in the interval  $[\varepsilon, 4\varepsilon]$ . Iterating again, we have that the prices in the interval  $[2\varepsilon, 3\varepsilon]$  have best responses in the interval  $[3\varepsilon, 4\varepsilon]$ , while the prices in the interval  $(3\varepsilon, 4\varepsilon]$  have no best response. Thus we are able to delete those prices in the intervals  $[2\varepsilon, 3\varepsilon)$  since they are never a best response to any price in the interval  $[2\varepsilon, 4\varepsilon]$ . Iterating, we have that the price  $3\varepsilon$  has a best response,  $4\varepsilon$ , while the prices in the interval  $(3\varepsilon, 4\varepsilon]$  have no best response. Thus we are able to delete those prices in the intervals  $[3\varepsilon, 4\varepsilon)$  since they are never a best response to any price in the interval  $[3\varepsilon, 4\varepsilon]$ . Finally, we see that the price  $4\varepsilon$  has no best response, thus we are able to delete the price  $4\varepsilon$  since it is not a best response to the only remaining candidate for a rationalisable price,  $4\varepsilon$ . QED.

This is a strong and surprising result, it says that in the game where firms are restricted to playing only pure strategies there are no strategies which it would be reasonable for the firms to play if they were rational and if their rationality were common knowledge. Our result is consistent with Proposition 3.2 in Bernheim (1984):

*Assume  $S_i \subset \mathbb{R}^n$  is compact for all  $i$ , and utility functions are continuous. Then there will exist at least one rationalisable strategy.*

In our model, firms' profit functions are clearly not continuous in the prices they offer; in particular, there are discrete jumps in profits when firms' prices are exactly  $\epsilon$  apart. Since Nash equilibria must be rationalisable we have the corollary:

**Corollary 1:** *When firms are restricted to playing pure strategies there does not exist a Nash equilibrium of the game.*

## 5.2 RATIONALISABILITY WITH DISCRETE PRICES

The reason why there are no rationalisable strategies in the game above is that when firms would prefer to respond to their competitor's price by 'undercutting' rather than 'exploiting', whichever price they chose, there was always some price slightly higher which did better. This meant that there was no best response for firm  $i$  to firm  $j$  offering a price greater than  $3\epsilon$ . This stems from the fact that firms strategy sets were not finite and they could choose any continuous price in the interval  $[0, 1]$ . Indeed, we will see that if we make prices discrete there will exist some rationalisable strategies in the pure strategy game. Let  $\delta > 0$ , be the length of the interval between one discrete price and the next. This means that the prices that firms can offer must be some integer multiple of  $\delta$ . We also make the following simplifying assumption:

**Assumption 1:** *The search cost  $\epsilon$ , as well as integer multiples of  $\epsilon$  can be offered as prices. That is,  $K\delta = \epsilon$ . Where  $K$  is some large integer.*

To find firm  $i$ 's best response to firm  $j$ 's price we note (keeping in mind our earlier analysis) that there are now two possible candidates for a best response to  $p_j$ :<sup>5</sup>

1.  $p_i = p_j + \epsilon$ . Which we call 'exploit' i.e. the highest price which retains half of the consumers.

---

<sup>5</sup> Assuming  $p_j + \epsilon \leq 1$ .



2.  $p_i = p_j - \varepsilon - \delta$ . Which we call ‘undercut’ i.e. the highest price which attracts all of the consumers.

Associated profits are then:

$$(E)xploit: \pi_i(E) = \frac{1}{2}(p_j + \varepsilon)$$

$$(U)ndercut: \pi_i(U) = p_j - \varepsilon - \delta$$

Comparing profits in these two cases tells us that firm i prefers to play U when responding to prices  $p_j > 3\varepsilon + 2\delta$ , and play E for prices less than  $3\varepsilon + 2\delta$  and is indifferent between playing U and E at  $p_j = 3\varepsilon + 2\delta$ . This gives us firm i’s best response function:

$$BR_i(p_j) = \begin{cases} p_j - \varepsilon - \delta, & p_j \geq 3\varepsilon + 2\delta \\ p_j + \varepsilon, & p_j \leq 3\varepsilon + 2\delta \end{cases}$$

That is, when firm j is offering a price less than or equal to  $3\varepsilon + 2\delta$ , firm i’s best response is to offer a price  $\varepsilon$  greater and still sell to half the market. While if firm j offers a price greater than or equal to  $3\varepsilon + 2\delta$ , firm i’s best response is to offer the highest price which will allow him to sell to all of the consumers.

**Result 2:** *If firms are restricted to pure strategies and Assumption 1 holds, the set of rationalisable pure strategies are those (discrete) prices which lie in the interval  $[2\varepsilon + \delta, 4\varepsilon + 2\delta]$ .*

**Proof:** The set of rationalisable strategies are those which remain after the iterative deletion of strategies which are never a best response. Consider first those (discrete) prices in the interval  $[0, 3\varepsilon + 2\delta]$ , the best responses to these will be those discrete prices in the interval  $[\varepsilon, 4\varepsilon + 2\delta]$ . While for those (discrete) prices in the interval  $[3\varepsilon + 2\delta, 1]$ , the best responses to these will be those discrete prices in the interval  $[2\varepsilon + \delta, 1 - \varepsilon - \delta]$ . Thus we can delete those discrete prices in the intervals  $[0, \varepsilon - \delta]$  and  $[1 - \varepsilon, 1]$  since they are never a best response. Continuing in this fashion we are able to delete pure strategies (discrete prices) until we are left with those discrete prices in the interval  $[2\varepsilon + \delta, 4\varepsilon + 2\delta]$ . QED.

Another way of seeing this result is to note that a rationalisable strategy is one which can be defended by some (infinite) chain of justification. Take any discrete price in the interval  $[2\epsilon + \delta, 4\epsilon + 2\delta]$ , say  $3\epsilon$ , this is a best response to the other player playing  $4\epsilon + \delta$ , which is in turn a best response to  $3\epsilon + \delta$ . Continuing in this fashion we have:  $3\epsilon, 4\epsilon + \delta, 3\epsilon + \delta, 4\epsilon + 2\delta, 3\epsilon + 2\delta, 2\epsilon + 2\delta, 3\epsilon + 3\delta, 2\epsilon + 3\delta, \dots, 4\epsilon - \delta, 3\epsilon - \delta, 4\epsilon, 3\epsilon, \dots$  this infinite chain of justification justifies every price which features at some point in the chain.

**Corollary 2:** *As  $\delta \rightarrow 0$ , the set of rationalisable pure strategies tends to those (discrete) prices in the interval  $[2\epsilon, 4\epsilon]$ .*

We have to be slightly careful here, we know that when  $\delta = 0$  (i.e. continuous prices) there will not be any rationalisable prices. However, so long as  $\delta > 0$ , no matter how small  $\delta$  becomes, there will exist rationalisable prices, and the set of rationalisable prices will tend to the interval  $[2\epsilon, 4\epsilon]$  as  $\delta$  tends to zero.

We call the price path that two firms would follow if they were continually able to change their action to best respond to their opponent's current action, the *pure strategy dynamics* of the game. Suppose firm i begins by offering the price  $4\epsilon$ , firm j will respond by choosing  $3\epsilon - \delta$ , firm i will then lower his price to  $4\epsilon - \delta$ , firm j will lower his price by  $\delta$ , and so on. They will engage in this quasi-Bertrand competition, whilst always maintaining an  $\epsilon$  gap between their prices until firm i's price falls to  $3\epsilon + 2\delta$ , at this point firm j may choose to jump his price from  $2\epsilon + 2\delta$  to  $4\epsilon + 2\delta$  and the cycle of undercutting one another begins again.

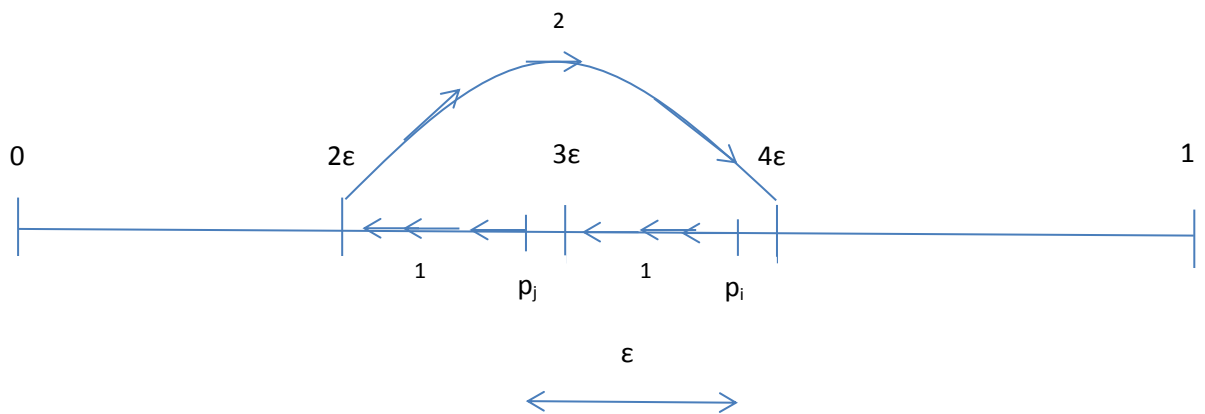

**Figure 3: The pure strategy dynamics of firm pricing.**

In the diagram above, in stage 1, firms undercut one another while maintaining an  $\epsilon$ -gap. In stage 2, one of the firms offers a price (approximately) equal to  $3\epsilon$  which causes the price of their competitor to jump from (approximately)  $2\epsilon$  to  $4\epsilon$ . Firms then enter stage 1 again and the cycle continues.

In contrast, consider any price outside of the interval  $[2\epsilon + \delta, 4\epsilon + 2\delta]$  it is impossible to create an infinite chain of (pure) justification. For example, take the price  $1.5\epsilon$ , this is a best response to  $0.5\epsilon$ , but  $0.5\epsilon$  is not a best response to any price in  $[0, 1]$ . Similarly, consider a price of  $5\epsilon$ , this is a best response to  $6\epsilon + \delta$  which is a best response to  $7\epsilon + 2\delta$ . Notice how approximately  $\epsilon$  is added at each stage until eventually the price being played by the opponent to justify your price must be greater than 1.

We know that in the continuous version of the game where firms are restricted to pure strategies, not only does there not exist a Nash equilibrium, there does not even exist a single rationalisable strategy. When prices are discrete then we have shown that there will exist rationalisable strategies. Will any of these be Nash equilibrium? The answer is no.

**Result 3:** *There does not exist a Nash equilibrium in pure strategies in the game where firms are restricted to discrete prices.*

**Proof:** We know that the best response correspondence for firm  $i$  (symmetrically for firm  $j$ ) is

$$BR_i(p_j) = \begin{cases} p_j - \varepsilon - \delta, & p_j \geq 3\varepsilon + 2\delta \\ p_j + \varepsilon, & p_j \leq 3\varepsilon + 2\delta \end{cases}$$

We are searching for a pair of prices  $(p_i, p_j)$  such that  $p_i \in BR_i(p_j)$  and  $p_j \in BR_j(p_i)$ . Suppose there is an equilibrium where firm j offers a price  $p_j \leq 3\varepsilon + 2\delta$ , then firm i's best response will be to offer the price  $p_i = p_j + \varepsilon$ . If this price  $p_i$  is:

- (i) Less than or equal to  $3\varepsilon + 2\delta$ , firm j's best response to firm i's price will be  $p_j = p_i + \varepsilon = p_j + 2\varepsilon$ . Clearly this is a contradiction and cannot be an equilibrium.
- (ii) Greater than or equal to  $3\varepsilon + 2\delta$ , firm j's best response to firm i's price will be  $p_j = p_i - \varepsilon - \delta = p_j - \delta$ . Clearly this is a contradiction and cannot be an equilibrium.

Now suppose there is an equilibrium where firm j offers a price  $p_j \geq 3\varepsilon + 2\delta$ , firm i's best response will be to offer the price  $p_i = p_j - \varepsilon - \delta$ . If this price  $p_i$  is:

- (i) Less than or equal to  $3\varepsilon + 2\delta$ , firm j's best response to firm i's price will be  $p_j = p_i + \varepsilon = p_j - \delta$ . Clearly this is a contradiction and cannot be an equilibrium.
- (ii) Greater than or equal to  $3\varepsilon + 2\delta$ , firm j's best response to firm i's price will be  $p_j = p_i - \varepsilon - \delta = p_j - 2\varepsilon - 2\delta$ . Clearly this is a contradiction and cannot be an equilibrium.

QED

Another way of seeing this result is to plot both firms' best responses and note that there does not exist a price pair  $(p_i, p_j)$  where firms' best responses intersect.<sup>6</sup>

---

<sup>6</sup> We have drawn the best response correspondence as though it was continuous although it is actually for discrete prices which are very close together. Nevertheless, the intuition and the result is the same.

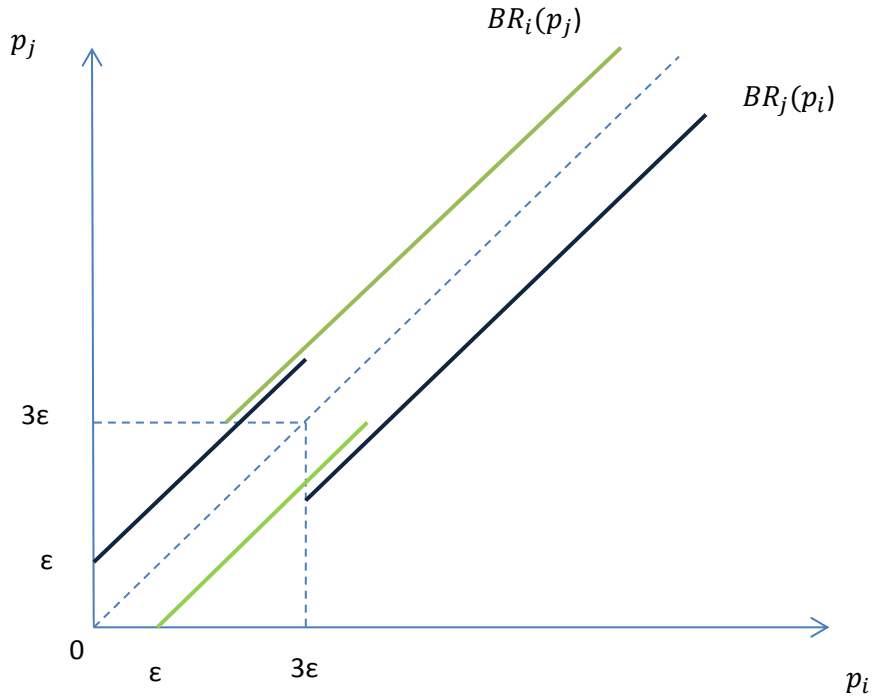

Figure 4: Firms' best response functions

### 5.3 MIXED STRATEGIES

In this sub-section, we allow firms to play mixed strategies and only consider the case where prices are continuous, that is, firms can offer any real number in the interval  $[0, 1]$  as their price. Firstly, we eliminate some prices using strict dominance arguments. We know that such prices will never be part of a mixed strategy that firms play in equilibrium. Next, over a number of steps, we argue that a symmetric equilibrium strategy, if it exists, must play a price distribution which is atomless and has full support on some interval of  $2\epsilon$  length. Finally, we prove the substantial result of this chapter which is that there is a unique symmetric mixed strategy equilibrium of our game where firms offer prices according to the distribution

$$F(p) = \begin{cases} 1 - \frac{(1 + \sqrt{2})\epsilon}{p + \epsilon}, & p \in [\sqrt{2}\epsilon, (1 + \sqrt{2})\epsilon]; \\ 2 \left[ 1 - \frac{(1 + \sqrt{2})\epsilon}{2(p - \epsilon)} \right], & p \in [(1 + \sqrt{2})\epsilon, (2 + \sqrt{2})\epsilon]. \end{cases}$$

**Lemma 1:** *When firms can play mixed strategies, prices in the interval  $[0, \sqrt{2}\epsilon)$  do not survive the iterated deletion of prices which are strictly dominated.*

**Proof:** In this proof we first consider which strategies from the bottom of the interval  $[0, 1]$  can be strictly dominated by the alternative strategy of offering a price  $\epsilon$  greater than the current lowest price which has not yet been shown to be strictly dominated. We iterate this process and find the limiting case. We then show that we can strictly dominate even more prices if we consider an alternative strategy which randomises. We iterate this process and find the limiting case.

Consider that if firm  $i$  offers a price of  $\epsilon$ , it will sell to half of the consumers if firm  $j$  offers a price in the interval  $[0, 2\epsilon]$ , and all of the consumers if firm  $j$  offers a price greater than  $2\epsilon$ . Thus we have

$$\pi_i(\epsilon, p_j) = \begin{cases} \frac{\epsilon}{2}, & p_j \in [0, 2\epsilon] \\ \epsilon, & p_j > 2\epsilon \end{cases}$$

By using this strategy, firm  $i$  can guarantee itself at least a payoff of  $\epsilon/2$ . Thus, offering a price less than  $\epsilon/2$  must be strictly dominated by offering the price  $\epsilon$ . Now that we know that no firm will ever offer a price less than  $\epsilon/2$ , we consider firm  $i$  offering the price  $\epsilon$  greater than the lowest price which has not yet been deleted i.e.  $3\epsilon/2$ , depending on  $p_j$ , this will yield profits

$$\pi_i(3\epsilon/2, p_j) = \begin{cases} \frac{3\epsilon}{4}, & p_j \in \left[\frac{\epsilon}{2}, \frac{5\epsilon}{2}\right] \\ \frac{3\epsilon}{2}, & p_j > \frac{5\epsilon}{2} \end{cases}$$

Since no firm will offer a price less than  $\epsilon/2$ , firm  $i$  can guarantee itself a payoff of at least  $3\epsilon/4$  by offering a price of  $3\epsilon/2$ . This allows us to delete prices less than  $3\epsilon/4$ . Iterating in this fashion allows us to delete all prices less than  $\epsilon$ . To see this, let  $\tilde{p}$  be the lowest price which survives the iterative deletion of prices which are strictly dominated using this particular alternative strategy of offering a price  $\epsilon$  greater than the current lowest price which has not been deleted. Profits to firm  $i$  of offering a price  $\epsilon$  greater than  $\tilde{p}$  are:

$$\pi_i(\tilde{p} + \varepsilon, p_j) = \begin{cases} \frac{\tilde{p} + \varepsilon}{2}, & p_j \in [\tilde{p}, \tilde{p} + 2\varepsilon] \\ \tilde{p} + \varepsilon, & p_j > \tilde{p} + 2\varepsilon \end{cases}$$

That is, firm i can guarantee itself a payoff of  $\frac{\tilde{p} + \varepsilon}{2}$ . If this is indeed the limiting case of the current iterative process, it must be that  $\frac{\tilde{p} + \varepsilon}{2} = \tilde{p}$ , which implies  $\tilde{p} = \varepsilon$ . So far, we have been able to show that no firm will offer a price in the interval  $[0, \varepsilon)$ , but we can in fact delete more prices than this from the bottom of  $[0, 1]$ . Consider the pure strategy  $s_i$  which plays  $p_i \geq \varepsilon$  for sure, and the alternative strategy  $s'_i$  which involves playing  $p_i + \varepsilon$  with probability  $\sigma$  and  $p_i + 2\varepsilon \leq 1$  with probability  $1 - \sigma$ .

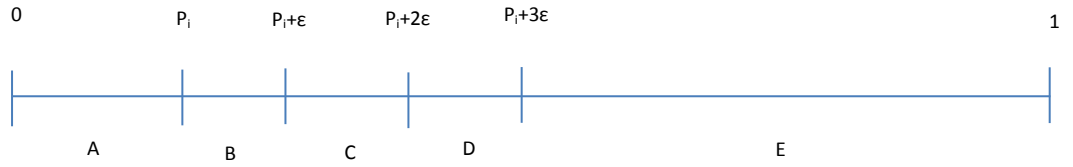

Figure 5: Different regions in which firm j can offer prices.

Consider profits to firm i – when playing the two different strategies – when firm j prices in the different regions (A, B, ..., E):

Region A: Since we are searching for the limit of this iterative process, we need not consider firm j pricing in this interval since it would have been deleted in some earlier round of iterative deletion.

Region B: In this region, firm j offers prices in the interval  $[p_i, p_i + \varepsilon]$ . Profits to firm i in this case for the two strategies are

$$\pi_i(s_i, B) = \frac{1}{2}p_i, \quad \pi_i(s'_i, B) = \frac{\sigma}{2}(p_i + \varepsilon).$$

In order for strategy  $s'_i$  to strictly dominate strategy  $s_i$ , it must be that

$$\pi_i(s'_i, B) > \pi_i(s_i, B) \Leftrightarrow \sigma > \frac{p_i}{p_i + \varepsilon} \quad (1)$$

Region C: In this region, firm j offers prices in the interval  $[p_i + \varepsilon, p_i + 2\varepsilon]$ . Profits to firm i in this case for the two strategies are

$$\pi_i(s_i, C) = p_i, \quad \pi_i(s'_i, C) = \frac{1}{2}[\sigma(p_i + \varepsilon) + (1 - \sigma)(p_i + 2\varepsilon)]$$

In order for strategy  $s'_i$  to strictly dominate strategy  $s_i$ , it must be that

$$\pi_i(s'_i, C) > \pi_i(s_i, C) \Leftrightarrow \frac{1}{2}[\sigma(p_i + \varepsilon) + (1 - \sigma)(p_i + 2\varepsilon)] > p_i \quad (2)$$

Call  $\hat{p}$  the lowest price which cannot be shown to be strictly dominated using this argument. If this is the case,  $\hat{p}$  will (just) fail to satisfy the conditions (1) and (2), so that

$$\sigma = \frac{\hat{p}}{\hat{p} + \varepsilon} \text{ and } \frac{1}{2}[\sigma(\hat{p} + \varepsilon) + (1 - \sigma)(\hat{p} + 2\varepsilon)] = \hat{p}.$$

Solving for  $\hat{p}$  give us that  $\hat{p} = \sqrt{2}\varepsilon$ . That is, for any  $p_i$  less than  $\hat{p}$  we can always find a  $\sigma > \frac{p_i}{p_i + \varepsilon}$

such that  $\frac{1}{2}[\sigma(p_i + \varepsilon) + (1 - \sigma)(p_i + 2\varepsilon)] > p_i$

Region D: In this region, firm j offers prices in the interval  $[p_i + 2\varepsilon, p_i + 3\varepsilon]$ . Profits to firm i in this case for the two strategies are

$$\pi_i(s_i, D) = p_i, \quad \pi_i(s'_i, D) = \sigma(p_i + \varepsilon) + \frac{1 - \sigma}{2}(p_i + 2\varepsilon)$$

In order for strategy  $s'_i$  to strictly dominate strategy  $s_i$ , it must be that

$$\pi_i(s'_i, D) > \pi_i(s_i, D) \Leftrightarrow \sigma(p_i + \varepsilon) + \frac{1 - \sigma}{2}(p_i + 2\varepsilon) > p_i \quad (3)$$

We know from condition (1) that for strategy  $s'_i$  to strictly dominate strategy  $s_i$ , it must be that  $\sigma > \frac{p_i}{p_i + \varepsilon}$ . If we can show that condition (3) holds for  $\sigma = \frac{p_i}{p_i + \varepsilon}$  then it must hold for all  $\sigma > \frac{p_i}{p_i + \varepsilon}$ .

This is because increasing  $\sigma$ , increases the weight on  $p_i + \varepsilon$ , which is greater than  $p_i$ . Thus, we need that

$$p_i + \frac{1 - \sigma}{2}(p_i + 2\varepsilon) > p_i$$



Which is always satisfied.

Region E: Here both strategies attract all the consumers, meaning that  $s'_i$  must do strictly better than  $s_i$  since it is associated with strictly higher prices.

QED

**Lemma 2:** *Prices in the interval  $(4\varepsilon, 1]$  do not survive the iterated deletion of prices which are strictly dominated.*

**Proof:** Consider ‘dominance from the top’ i.e. see which prices we can rule out by iteratively deleting strictly dominated prices from the top of the interval  $[0, 1]$ :

Again  $s_i$  is a pure strategy which plays  $p_i$  for sure, while  $s'_i$  this time, plays  $p_i - 2\varepsilon$  for sure:

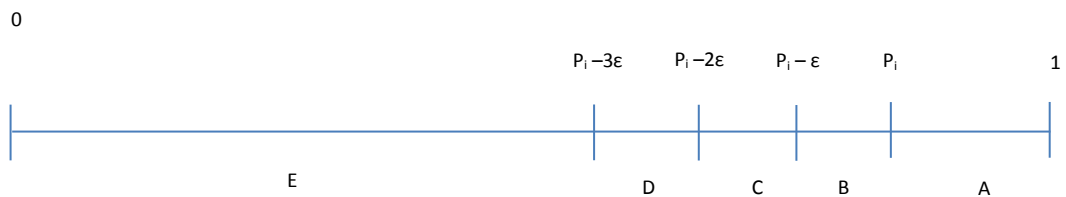

Figure 6: Different regions in which firm j can offer prices.

Consider profits to firm i when firm j prices in the different regions (A, B, C, D, E):

A: So long as we can show that  $p_i$  does not survive the iterative deletion of strategies which are strictly dominated, then we can ignore prices in this region since they too will have been deleted in some earlier round of deletion.

Region B: In this region, firm j offers prices in the interval  $[p_i - \varepsilon, p_i]$ . Profits to firm i in this case for the two strategies are

$$\pi_i(s_i, B) = \frac{1}{2}p_i, \quad \pi_i(s'_i, B) = p_i - 2\varepsilon$$

In order for strategy  $s'_i$  to strictly dominate strategy  $s_i$ , it must be that

$$\pi_i(s'_i, B) > \pi_i(s_i, B) \Leftrightarrow p_i > 4\varepsilon \quad (4)$$

Region C and D: In this region, firm j offers prices in the intervals  $[p_i - 2\varepsilon, p_i - \varepsilon]$  or  $[p_i - 3\varepsilon, p_i - 2\varepsilon]$ . Profits to firm i in this case for the two strategies are

$$\pi_i(s_i, C) = \pi_i(s_i, D) = 0, \quad \pi_i(s'_i, C) = \pi_i(s'_i, D) = \frac{1}{2}(p_i - 2\varepsilon)$$

We know from condition (4) that in order for  $s_i$  to be strictly dominated by  $s'_i$ , it is necessary for  $p_i$  to be greater than  $4\varepsilon$ . This being the case, we know that for these prices, strategy  $s'_i$  strictly dominates strategy  $s_i$

$$\pi_i(s'_i, C) = \pi_i(s'_i, D) > \pi_i(s_i, C) = \pi_i(s_i, D)$$

Region E: In this region, firm j offers prices in the interval  $[0, p_i - 3\varepsilon]$ . Profits to firm i in this case for the two strategies are

$$\pi_i(s_i, E) = \pi_i(s'_i, E) = 0$$

Clearly, here,  $s'_i$  does not strictly dominate  $s_i$ . However we will still be okay if we amend the strategy  $s'_i$  (call it  $s''_i$ ) so that instead of offering the price  $p_i - 2\varepsilon$  for sure, it offers it with probability  $1 - \mu$ , where  $\mu$  is some small strictly positive real number. With the remaining  $\mu$  probability, strategy  $s''_i$  is equally likely to offer one of the prices  $p_i - 4\varepsilon, p_i - 6\varepsilon, p_i - 8\varepsilon$  and so on.<sup>7</sup> This will mean that  $\pi_i(s''_i, E) > 0$ . Furthermore, strategy  $s''_i$  does almost as well as strategy  $s'_i$  in the other regions. Stating this formally, for any  $p_i > 4\varepsilon$ , one can always find a  $\mu > 0$  sufficiently small such that  $\pi_i(s''_i, B) > \pi_i(s_i, B)$ . In the other regions, it is easy to see that  $\pi_i(s''_i) > \pi_i(s_i)$  for sufficiently small  $\mu$ . QED

We know that any candidate for an equilibrium must only offer prices in the interval  $[\sqrt{2}\varepsilon, 4\varepsilon]$  with positive probability. In what follows, we consider only symmetric equilibria.

**Lemma 3:** *The range of prices being played in a symmetric equilibrium must be greater than  $\varepsilon$ .*

---

<sup>7</sup> Notice that, since  $p_i$  is finite and  $\varepsilon > 0$ , strategy  $s''_i$  will offer only a finite number of prices, each with strictly positive probability.

**Proof:** Suppose there is an equilibrium where firms play prices within an interval of length less than or equal to  $\epsilon$ , this means that at any price in that interval a firm would attract exactly half of the consumers. This is inconsistent with equilibrium since the highest price in this interval will yield strictly greater profits than any other price in the interval. QED

**Lemma 4:** *There can be no mass points in the symmetric equilibrium strategy.*

**Proof:** Suppose that there was a mass point in the equilibrium strategy of firm  $i$  at price  $p \in [\sqrt{2}\epsilon, 4\epsilon]$ . Consider three cases: (i)  $p \in [\sqrt{2}\epsilon, (1 + \sqrt{2})\epsilon]$  (ii)  $p \in [(1 + \sqrt{2})\epsilon, 3\epsilon]$  (iii)  $p \in [3\epsilon, 4\epsilon]$

Case (i): Firm  $j$  reasons that there will be a discontinuous fall in its profit at  $p+\epsilon$ . This is because at a price of  $p+\epsilon$  or below, firm  $j$  will 'draw' with the mass (i.e. they will split the market equally) but at a price above  $p+\epsilon$ , firm  $j$  will 'lose' against the mass. Thus, for firm  $j$ , playing the price  $p+\epsilon$  dominates the prices in some interval  $(p+\epsilon, q+\epsilon]$ , where  $q$  is some price greater than  $p$ . This means that firm  $j$  will not play in this interval if there is a mass at  $p$ . Firm  $i$  now notices that it can do better than playing  $p$ , in particular by playing  $q$ , it now attracts the same proportion of consumers as if it were playing  $p$  but is able to charge a higher price, thus there can be no mass at  $p$ .

Case (ii): In this case there are two regions which become dominated for firm  $j$ ,  $[p-\epsilon, q]$  and  $(p+\epsilon, r]$ , where  $q$  is some price less than  $p$ , and  $r$  is some price greater than  $p+\epsilon$ . Firm  $i$  now reasons that offering the price  $p+\delta$  dominates offering the price  $p$ , since it is able to sell to the same proportion of consumers but at a higher price.

Case (iii): In this case the region  $[p-\epsilon, q-\epsilon]$  becomes dominated for firm  $j$ , where  $q$  is some price greater than  $p$ . Due to this, firm  $i$  can do strictly better playing  $q$  instead of  $p$ .

QED

Since there are no mass points, it follows that a symmetric equilibrium, if it exists, must involve firms offering prices in a single continuous interval or a number of continuous intervals. We will

prove that in a symmetric equilibrium, if one exists, it cannot be that there are a number of continuous intervals, there must be only one. First we will need another lemma.

**Lemma 5:** *If all the prices in some interval  $[a, b]$  are in the support of the symmetric equilibrium distribution of prices  $F$ , it must be the case that all of the prices, either in the interval  $[a-\varepsilon, b-\varepsilon]$  or the interval  $[a+\varepsilon, b+\varepsilon]$  (but not both) are also in the support of  $F$ .*

**Proof:** The proof is in two parts.

- (i) We show that if the interval  $[a, b]$  is played in equilibrium so must the interval  $[a-\varepsilon, b-\varepsilon]$  and/or the interval  $[a+\varepsilon, b+\varepsilon]$ .
- (ii) It cannot be that all three intervals are played in equilibrium

(i) In equilibrium, profits in the interval  $[a, b]$  must be constant, thus a firm must be indifferent between charging a price  $p \in (a, b)$  and a price slightly below  $p$ , say  $p' \in [a, b)$ . In order to compensate the firm for the lower price, at the price  $p'$  it must be that they (in expectation) attract some additional consumers compared to when they offer the price  $p$ . The only state of the world when a firm offering the price  $p'$  attracts more consumers than offering a price  $p$  is when their opponent offers a price in the interval  $[a-\varepsilon, b-\varepsilon]$  or the interval  $[a+\varepsilon, b+\varepsilon]$ . Since we are considering symmetric equilibria, the set of prices being offered will be the same for both firms. Thus if the interval  $[a, b]$  is in the support of  $F$  it must be that at least one of the intervals  $\{[a-\varepsilon, b-\varepsilon], [a+\varepsilon, b+\varepsilon]\}$  is also in the support.

(ii) Suppose that all three intervals are played in equilibrium. Suppose firm  $j$  randomises according to the distribution  $F$ . If firm  $i$  chooses a price  $p_i \in [a - \varepsilon, b - \varepsilon]$  this will yield an expected profit of:

$$\begin{aligned} E[\pi_i(p_i, F)] &= \left[ \frac{1}{2}F(p_i + \varepsilon) + (1 - F(p_i + \varepsilon)) \right] p_i \\ &= \left[ 1 - \frac{1}{2}F(p_i + \varepsilon) \right] p_i. \end{aligned}$$

From lemmas 1 and 2 we know that at these prices, firm i will sell to either, half of the consumers or all of the consumers i.e. it is not possible for firm j to offer a price less than  $b - 2\varepsilon$  and sell to the entire market as this would mean that the range of prices being offered would be at least  $3\varepsilon$  which is not consistent with lemmas 1 and 2. Since  $E[\pi_i(p_i, F)]$  must be constant for all prices in the support, we can let  $E[\pi_i(p_i, F)] = \pi$  and rearrange the above to get

$$F(p_i + \varepsilon) = 2 \left[ 1 - \frac{\pi}{p_i} \right], \quad p_i \in [a - \varepsilon, b - \varepsilon].$$

This is true for  $p_i \in [a - \varepsilon, b - \varepsilon]$ , so  $F(p_i + \varepsilon)$  tells us about the behaviour of  $F(\cdot)$  for prices in the interval  $[a, b]$ . Giving us that

$$F(p_i) = 2 \left[ 1 - \frac{\pi}{p_i - \varepsilon} \right], \quad p_i \in [a, b].$$

Similarly, if firm i chooses a price  $p_i \in [a + \varepsilon, b + \varepsilon]$  this will yield an expected profit of

$$E[\pi_i(p_i, F)] = \frac{1}{2} (1 - F(p_i - \varepsilon)) p_i.$$

Again, setting  $E[\pi_i(p_i, F)] = \pi$  and rearranging we have

$$F(p_i - \varepsilon) = 1 - \frac{2\pi}{p_i}, \quad \text{for } p_i \in [a + \varepsilon, b + \varepsilon].$$

This is true for  $p_i \in [a + \varepsilon, b + \varepsilon]$ , so  $F(p_i - \varepsilon)$  also tells us about the behaviour of  $F(\cdot)$  for prices in the interval  $[a, b]$ . Giving us that

$$F(p_i) = 1 - \frac{2\pi}{p_i + \varepsilon}, \quad p_i \in [a, b].$$

We now have two expressions that  $F$  must satisfy in order to qualify as a candidate for an equilibrium. We need that they are consistent with one another, which requires

$$2 \left[ 1 - \frac{\pi}{p_i - \varepsilon} \right] = 1 - \frac{2\pi}{p_i + \varepsilon}, \quad \forall p_i \in [a, b]$$

$$\Rightarrow p_i = [4\pi\varepsilon + \varepsilon^2]^{\frac{1}{2}} \quad \forall p_i \in [a, b]$$

This cannot be true for any range of prices since this expression tells us that  $p_i$  is equal to a constant. QED.

**Lemma 6:** *The support of the symmetric equilibrium distribution – if it exists – must be one continuous interval  $[\sqrt{2}\varepsilon, (2 + \sqrt{2})\varepsilon]$ .*

**Proof:** We know from lemma 5 that intervals of prices must occur in pairs in the equilibrium price distribution.<sup>8</sup> Consider a distribution  $F$ , which consists only of playing the distinct intervals  $[a_0, b_0], [a_1, b_1], \dots, [a_n, b_n], [a_0+\varepsilon, b_0+\varepsilon], \dots, [a_n+\varepsilon, b_n+\varepsilon]$ . We can show that in order for this to be a candidate for a symmetric equilibrium it must be that there are no gaps in between these intervals. From the proof of lemma 5 we know that for each pair, the ‘lower’ interval i.e. the intervals  $[a_0, b_0], [a_1, b_1], \dots, [a_n, b_n]$  must have CDF

$$F(p_i) = 1 - \frac{2\pi}{p_i + \varepsilon}$$

While the ‘upper’ interval i.e. the intervals  $[a_0+\varepsilon, b_0+\varepsilon], \dots, [a_n+\varepsilon, b_n+\varepsilon]$  must have CDF

$$F(p_i) = 2 \left[ 1 - \frac{\pi}{p_i - \varepsilon} \right]$$

Since our distribution is atomless it must be that  $F(a_0) = 0 \Rightarrow \pi = \frac{1}{2}(a_0 + \varepsilon)$  and also  $F(b_n + \varepsilon) = 1 \Rightarrow \pi = \frac{b_n}{2}$ . Equating these two expressions for profits tells us

$$\frac{1}{2}(a_0 + \varepsilon) = \frac{b_n}{2} \Rightarrow b_n = a_0 + \varepsilon$$

So, we have shown that if the smallest price being played is  $a$ , the largest prices being played must be  $a + 2\varepsilon$ . Again using the fact that the distribution is atomless it must be that  $F(b_k) = F(a_{k+1})$  for  $k = 0, 1, \dots, n - 1$ . Which, in conjunction with our knowledge of the CDF, implies that  $b_k = a_{k+1}$  for  $k = 0, 1, \dots, n - 1$ . This tells us that there will be no gaps in the distribution between  $[a_0, b_n] = [a_0, a_0 + \varepsilon]$ .

---

<sup>8</sup> A pair being two intervals  $[x, y]$  and  $[x + \varepsilon, y + \varepsilon]$

Inspecting the upper intervals we see that it must be that  $F(b_k + \varepsilon) = F(a_{k+1} + \varepsilon)$  for  $k = 0, 1, \dots, n - 1$ . Which implies that  $b_k + \varepsilon = a_{k+1} + \varepsilon$  for  $k = 0, 1, \dots, n - 1$ . This tells us that there will be no gaps in the distribution between  $[a_0 + \varepsilon, b_n + \varepsilon] = [a_0 + \varepsilon, a_0 + 2\varepsilon]$ . Finally, we need to check that these two intervals join together smoothly at  $a_0 + \varepsilon$ . That is, we need

$$1 - \frac{2\pi}{p_i + \varepsilon} \Big|_{p_i=a_0+\varepsilon} = 2 \left[ 1 - \frac{\pi}{p_i - \varepsilon} \right] \Big|_{p_i=a_0+\varepsilon}$$

Using  $\pi = \frac{1}{2}(a_0 + \varepsilon)$  and evaluating give us

$$\frac{\varepsilon}{a_0 + 2\varepsilon} = \frac{a_0 - \varepsilon}{a_0} \Rightarrow a_0 = \sqrt{2}\varepsilon$$

QED

A  $2\varepsilon$  length support is intuitive since any small change in price within the support leads to a small change in the expected number of consumers that a firm will sell to. With any other length of support we will run into problems. To see this, suppose that the support was  $[a, b]$  such that  $b - a \in (\varepsilon, 2\varepsilon)$ . Then it would be the case that any price in the interval  $[b - \varepsilon, a + \varepsilon]$  will sell to exactly half of the customers. This is because at these prices it is impossible to be further than  $\varepsilon$  away from the other firm's price. Thus the price  $a + \varepsilon$  dominates all other prices in the interval  $[b - \varepsilon, a + \varepsilon]$ , this means that those prices cannot be played in equilibrium and there is a 'gap' in the support. We have already shown how the support cannot have gaps in equilibrium. Now suppose instead that  $b - a > 2\varepsilon$ , for profits to be constant in this interval it must be that:

$$F(p_i) = \begin{cases} 1 - \frac{2\pi}{p_i + \varepsilon}, & p_i \in [b - 2\varepsilon, b - \varepsilon] \\ 2 \left[ 1 - \frac{\pi}{p_i - \varepsilon} \right], & p_i \in [a + \varepsilon, a + 2\varepsilon] \end{cases}$$

We also know from lemma 1 and 2 that  $b - a \leq (4 - \sqrt{2})\varepsilon$ . Which means that these two parts of the distribution must overlap in the interval  $[a + \varepsilon, b - \varepsilon]$ , this would require that:

$$2 \left[ 1 - \frac{\pi}{p_i - \varepsilon} \right] = 1 - \frac{2\pi}{p_i + \varepsilon} \quad \forall p_i \in [a + \varepsilon, b - \varepsilon]$$

Rearranging this expression in terms of  $p_i$  gives:

$$p_i = [4\pi\varepsilon + \varepsilon^2]^{\frac{1}{2}} \quad \forall p_i \in [a + \varepsilon, b - \varepsilon]$$

This cannot be the case since the expression on the right hand side is a constant and we know that  $p_i$  varies in this interval. Finally, we know from lemma 3 that the support cannot be of length less than or equal to  $\varepsilon$ , since, in that case, offering the highest price in the support will dominate all other prices in the support. We are now in a position to state and prove the main result of this chapter. What we find is that in this game, which can be considered a game of Bertrand competition with search costs, for small search costs, there is only a small deviation from the standard Bertrand model, however the deviation from marginal cost pricing is significant for search costs which are not small. Similarly the range of realised prices offered will be small if search costs are small and large if search costs are large.

**Result 4:** *There is a unique symmetric mixed-strategy Nash equilibrium on the interval  $[\sqrt{2}\varepsilon, (2 + \sqrt{2})\varepsilon]$  where both firms play according to*

$$F(p_i) = \begin{cases} 1 - \frac{(1 + \sqrt{2})\varepsilon}{p_i + \varepsilon}, & p_i \in [\sqrt{2}\varepsilon, (1 + \sqrt{2})\varepsilon]; \\ 2 \left[ 1 - \frac{(1 + \sqrt{2})\varepsilon}{2(p_i - \varepsilon)} \right], & p_i \in [(1 + \sqrt{2})\varepsilon, (2 + \sqrt{2})\varepsilon]. \end{cases}$$

*Expected profits to each firm in this case will be  $\mathbb{E}[\pi_i] = \frac{1}{2}(1 + \sqrt{2})\varepsilon$ .*



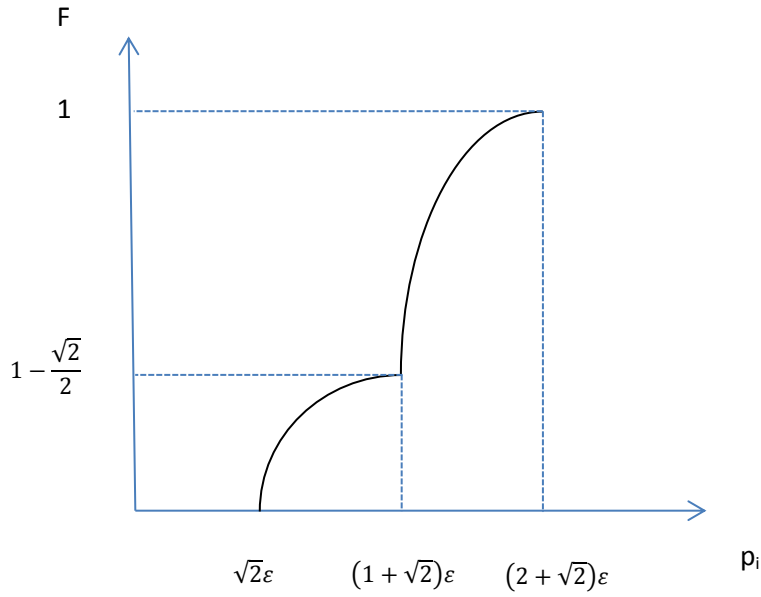

Figure 7: The cumulative distribution function of the symmetric equilibrium price distribution

**Proof:** We know from lemma 6 that our candidate for a symmetric equilibrium must satisfy

$$F(p_i) = \begin{cases} 1 - \frac{2\pi}{p_i + \varepsilon}, & p_i \in [\sqrt{2}\varepsilon, (1 + \sqrt{2})\varepsilon]; \\ 2 \left[ 1 - \frac{\pi}{(p_i - \varepsilon)} \right], & p_i \in [(1 + \sqrt{2})\varepsilon, (2 + \sqrt{2})\varepsilon]. \end{cases}$$

Since the support is of  $2\varepsilon$  length, offering the price exactly in the centre of the support,  $p_i = (1 + \sqrt{2})\varepsilon$ , will guarantee that a firm receives exactly half of the consumers. This is because it is impossible for the two prices to be more than  $\varepsilon$  apart if the other firm is offering prices according to  $F$ . This tells us that expected profits from offering a price in the interval must be  $\mathbb{E}[\pi_i] = \frac{1}{2}(1 + \sqrt{2})\varepsilon$ . We can now fully characterise  $F$

$$F(p_i) = \begin{cases} 1 - \frac{(1 + \sqrt{2})\varepsilon}{p_i + \varepsilon}, & p_i \in [\sqrt{2}\varepsilon, (1 + \sqrt{2})\varepsilon]; \\ 2 \left[ 1 - \frac{(1 + \sqrt{2})\varepsilon}{2(p_i - \varepsilon)} \right], & p_i \in [(1 + \sqrt{2})\varepsilon, (2 + \sqrt{2})\varepsilon]. \end{cases}$$

Finally, we need to check that a firm cannot do better by pricing outside of the interval when its opponent is offering prices according to  $F$ . We need to check two possible intervals of prices: (i)

$[(2 + \sqrt{2})\varepsilon, (3 + \sqrt{2})\varepsilon]$  and (ii)  $[(-1 + \sqrt{2})\varepsilon, \sqrt{2}\varepsilon]$ . This is because at prices greater than  $(3 + \sqrt{2})\varepsilon$  firms will attract no customers and a price of  $(-1 + \sqrt{2})\varepsilon$  is sufficiently low to attract all consumers.

$$(i) \quad p_i \in [(2 + \sqrt{2})\varepsilon, (3 + \sqrt{2})\varepsilon]$$

Pricing in this interval means:

$$\begin{aligned} E[\pi_i(p_i, F)] &= [1 - F(p_i - \varepsilon)] \frac{p_i}{2} \\ &= \left[ 1 - \left( 2 - \frac{(1 + \sqrt{2})\varepsilon}{p_i - 2\varepsilon} \right) \right] \frac{p_i}{2} \\ \Rightarrow \pi'_i(p_i) &= \frac{(1 + \sqrt{2})\varepsilon}{p_i - 2\varepsilon} \left[ 1 - \frac{p_i}{p_i - 2\varepsilon} \right] - 1 \end{aligned}$$

Since  $\frac{p_i}{p_i - 2\varepsilon} > 1$  it must be that  $\left[ 1 - \frac{p_i}{p_i - 2\varepsilon} \right] < 0$ . Since  $\frac{(1 + \sqrt{2})\varepsilon}{p_i - 2\varepsilon} > 0$  It is straightforward to see that for prices in this range

$$\pi'_i(p_i) < 0$$

Thus  $p_i = (2 + \sqrt{2})\varepsilon$  must do strictly better than all other prices in this interval

$$(ii) \quad p_i \in [(-1 + \sqrt{2})\varepsilon, \sqrt{2}\varepsilon]$$

Pricing in this interval means expected profits of

$$E[\pi_i(p_i, F)] = \left[ 1 - \frac{1}{2}F(p_i + \varepsilon) \right] p_i$$

Taking the derivate with respect to  $p_i$ :

$$\begin{aligned} \pi'_i(p_i) &= 1 - \frac{1}{2}F(p_i + \varepsilon) - \frac{p_i}{2}f(p_i + \varepsilon) \\ &= 1 - \frac{1}{2} \left[ 1 - \frac{(1 + \sqrt{2})\varepsilon}{p_i + 2\varepsilon} \right] - \frac{p_i}{2} \left[ \frac{(1 + \sqrt{2})\varepsilon}{(p_i + 2\varepsilon)^2} \right] \end{aligned}$$

$$= \frac{1}{2} + \frac{(1 + \sqrt{2})\varepsilon}{2(p_i + 2\varepsilon)} \left[ 1 - \frac{p_i}{p_i + 2\varepsilon} \right]$$

Clearly  $\frac{p_i}{p_i + 2\varepsilon} < 1$ , which means that  $\left[ 1 - \frac{p_i}{p_i + 2\varepsilon} \right] > 0$ . Since the other terms are clearly all positive we have that in this range of prices

$$\pi'_i(p_i) > 0$$

Thus  $p_i = \sqrt{2}\varepsilon$  must do strictly better than all other prices in this interval. QED.

Recall that strict dominance rules out prices outside the interval  $[\sqrt{2}\varepsilon, 4\varepsilon]$  being offered with positive probability. We have found an equilibrium where firms randomise on the interval  $[\sqrt{2}\varepsilon, (2 + \sqrt{2})\varepsilon]$ , in fact it is the unique symmetric mixed-strategy Nash equilibrium.

## 6 LINK TO THE DIAMOND PARADOX

This result has a clearly different flavour to Diamond (1971). In this model, if search costs are small there is not a significant departure from Bertrand competition. While in Diamond, strictly positive search costs, no matter how small, lead to monopoly pricing. What accounts for this difference? One can think of the Diamond model as having the same kind of structure as the model presented here, except that there are a large number of firms. This is a crucial difference since in Diamond's model one firm cannot 'induce search' by those consumers who initially visit other firms by offering a low price unilaterally, that is to say, even if one firm offers a very low price, consumers reason that it is not worth paying the search cost because the probability of actually visiting the store with the low price is small when the number of firms is large. While in our model, in the two-firm case, consumers know for sure what they are going to get if they search again. This makes it much easier for firms to attract consumers that do not initially visit them: they only need to offer a price which undercuts their competitor by more than  $\varepsilon$ .

Thus in the Diamond world there is only 'upward' price pressure, that is, firms only find reasons to offer higher prices than their competitors until the monopoly price is reached. While with a finite number of firms there is both upward pressure (offering a higher price than your

competitors in the knowledge that they are unlikely to search so long as your price is not too high, what I call ‘exploit’) and downward price pressure (offering a price sufficiently low to induce consumers who arrive at your competitors’ stores to continue their search, what I call ‘undercut’). Clearly as the number of firms increases, the downward pressure on prices decreases, this is because it becomes more difficult for firms to induce search on the part of consumers. That is, the more firms there are, the more aggressively a firm has to reduce its price in order to induce search. So, in this model we have the counterintuitive result that competition between two firms is close to Bertrand competition while increasing the number of firms leads to less intense competition and an increase in price, for small search costs. When the number of firms becomes large we have the Diamond paradox of monopoly pricing.

An interesting related question is: what is the minimum number of firms required for the Diamond paradox to hold? Suppose that there are  $N$  firms charging the monopoly price  $p=v$  and one firm is considering deviating by offering a price sufficiently low to induce search. What price will he have to charge in order to successfully attract consumers? For expositional simplicity and also to make the result analogous to the Diamond model: in the analysis which follows we ignore the initial search cost and assume that the consumer finds himself at one of the stores at the start of the game. Also, since it has some bearing on the result we assume that there is a fixed marginal cost of production for firms of  $c>0$ .

**Lemma 7:** *If all of the other firms are offering the monopoly price,  $v$ , in order to induce search, a firm must charge a price of less than or equal to  $v - \frac{N\varepsilon}{2}$ .*

**Proof:** Consider a consumer who is at one of the monopoly pricing firms, he can either purchase there, yielding zero surplus, or he can undertake search knowing that of the other  $N-1$  firms,  $N-2$  are offering the monopoly price and one is offering the price  $p$ . Notice that if he is willing to undertake a search at this stage i.e. when there is a  $1/(N-1)$  chance of ‘success’ he will prefer to continue searching for the low price until he finds it rather than stop his search and purchase at the monopoly price. Thus the consumer’s payoff from undertaking search is:

$$u(\text{search}) = \frac{1}{N-1}(v-p-\varepsilon) + \frac{N-2}{N-1} \cdot \frac{1}{N-2}(v-p-2\varepsilon) + \frac{N-2}{N-1} \cdot \frac{N-3}{N-2} \\ \cdot \frac{1}{N-3}(v-p-3\varepsilon) + \dots + \frac{N-2}{N-1} \cdot \frac{N-3}{N-2} \cdot \dots \cdot \frac{2}{3} \cdot \frac{1}{2} \cdot 1 \cdot (v-p-(N-1)\varepsilon)$$

The first term represents the consumers expected utility from finding the low price on the first search, the second term is the expected utility from finding the low price on the second search and so on. The final term represents the case where the consumer has to visit all the firms in order to find the low price. Notice that the probabilities in each case cancel to equal  $1/(N-1)$ . That is, given that if the consumer searches he is going to search until he finds the low price, there is an equal chance that he will undertake any number of searches in the set  $\{1, 2, \dots, N-1\}$ .

We have:

$$u(\text{search}) = \frac{1}{N-1}(v-p-\varepsilon) + \frac{1}{N-1}(v-p-2\varepsilon) + \dots + \frac{1}{N-1}(v-p-(N-1)\varepsilon) \\ = v-p - \left[ \frac{\varepsilon}{N-1} + \frac{2\varepsilon}{N-1} + \dots + \frac{(N-1)\varepsilon}{N-1} \right] \\ = v-p - \frac{\varepsilon}{N-1} [1 + 2 + \dots + (N-1)] \\ = v-p - \left( \frac{\varepsilon}{N-1} \right) \left( \frac{N-1}{2} \right) N \\ = v-p - \frac{N\varepsilon}{2}$$

In order for the consumers to search it must be that this is greater than zero, which requires that:

$$p \leq v - \frac{N\varepsilon}{2}$$

QED.

The intuition behind this is clear, if the DM chooses to search it must be that he will eventually purchase at price  $p$ , yielding him a surplus of  $v-p$  excluding search costs. Since he is uniformly likely to pay any number of search costs from 1 to  $N-1$ , at the start of the game, in expectation,

he will pay a total cost of search equal to  $\frac{N\varepsilon}{2}$ . Here we can see in another way why it must be that once search commences, the consumer will not stop until he finds the low price: as the consumer carries out more and more searches without finding the low price, the expected total additional search cost to find the low price is falling. That is to say, it achieves its maximum of  $N\varepsilon/2$  at the start of the game. While the benefit of finding the low price ( $v - p$ ) is unchanged. Since previous search costs are sunk, it makes sense to continue so long as the initial search was justified. We know what price a firm must charge in order to attract consumers, we now need to check that a firm will indeed prefer this to offering the monopoly price.

**Result 5:** *There exists an equilibrium where all firms charge the monopoly price  $v$  if and only if*

$$\varepsilon \geq \frac{2(N-1)(v-c)}{N^2}$$

**Proof:** By lemma 7 we know that if all the other firms are offering the monopoly price,  $v$ , then so long as a firm deviates by offering a price less or equal to  $v - \frac{N\varepsilon}{2}$  it can induce all of the consumers at the high price firms to search and continue to search until they purchase from his store. This means that the profit maximising price out of those prices which induce search is  $v - \frac{N\varepsilon}{2}$ . This yields profit to the firm of:

$$\pi(\textit{undercut}) = v - \frac{N\varepsilon}{2} - c$$

Alternatively, the firm could charge a price higher than the price which induces search, in which case the firm would receive  $1/N$  of the consumers as no consumers would search. Clearly the profit maximising price out of all those prices which do not induce search is the monopoly price, yielding profits to the firm of:

$$\pi(\textit{monopoly}) = \frac{v-c}{N}$$

Thus, all firms charging the monopoly price is an equilibrium so long as  $\pi(\textit{monopoly}) \geq \pi(\textit{undercut})$ , or equivalently,

$$\epsilon \geq \frac{2(N-1)(v-c)}{N^2}.$$

QED

This result is confirming our earlier intuition that when the number of firms,  $N$ , becomes large it is not in firms' interests to try to undercut their competitors since consumers will not be induced to search. In fact as  $N \rightarrow \infty$  we can see that any positive search cost is sufficient for monopoly pricing to be an equilibrium. The other thing that we learn from this result is that the larger the potential gain from trade,  $v - c$ , the larger the search cost has to be for monopoly pricing to result. We can see from inspecting the expressions for firm's profits that a larger potential gain from trade makes profits from undercutting seem more attractive, this is because the firm gets to keep the entire surplus,  $v - c$ , (which increases one-for-one with total surplus), less the expected consumer search cost,  $N\epsilon/2$  (which is unaffected by any increase in total surplus). Comparing this to profits from sticking with monopoly pricing,  $(v - c)/N$ , we can see that any increase in total surplus must be shared equally with all other firms. Finally, we notice that for a finite number of firms, sufficiently small search costs mean that monopoly pricing is no longer an equilibrium.

## 6.1 THE IMPORTANCE OF COMMITMENT

In the analysis so far we have assumed that firms are committed to the prices that they offer at the start of the game. There are perhaps good reasons for doing so: firms may for example have already publically advertised that they were offering a particular price or they may be legally bound to sell at the initially offered price. Nevertheless, we should note that if firms were not committed to the price that they offer, then typically on learning their competitors' price a firm may wish to change its price so that it is best responding to the realised distribution of prices rather than best responding in expectation. For example, in the two-firm case a firm whose realised price is more than  $\epsilon$  less than their competitor's price can do strictly better by increasing their price a little bit. Similarly, a firm whose price is more than  $\epsilon$  greater than their competitor's price will make no sales and will prefer to offer a price exactly  $\epsilon$  greater than their competitor.

Another way of seeing the problems which arise when firms are not committed to prices is as follows: suppose firm  $j$  is offering a price  $p_j$  then if firm  $i$  is not committed to the price it offers it may want to change its price so that it is less than  $p_j - \epsilon$ . If it does this, the consumers who are currently at firm  $j$  may be willing to pay a search cost in order to visit firm  $i$ . However, once they arrive at firm  $i$ 's store, firm  $i$  is not committed to offering the price that it said it would offer. Firm  $i$  now reasons that it can charge a price up to  $p_j + \epsilon$  and the consumers at its store will still purchase, rather than leave and pay a search cost. Realising this, the consumers do not search even if the other firm purports to offer a low price. We can formalise this argument with the following result:

**Result 6:** *If there are two or more firms who are not committed to the prices that they offer and search costs are strictly positive, then in the unique equilibrium all firms offer the monopoly price.*

**Proof:** First we distinguish between a credible and an incredible distribution of prices. We call a distribution of prices credible ( $F^C$ ) if a firm will actually be willing to sell to the consumer who visits its store at a price randomly drawn from it. Similarly, we call a distribution of prices incredible ( $F^I$ ) if a firm will not actually be willing to sell to the consumer who visits its store at a price randomly drawn from it. We ignore the consumers' initial search cost and assume that they are already at one of the stores. It is easy to see that a credible price distribution must satisfy (i) it never offers a price greater than the consumers reservation price,  $v$ , and (ii) it never offers a price less than the smallest credible price being offered by other firms plus a single search cost, unless such a price is greater than the consumers' reservation price, in which case it offers the reservation price.

So we have that a credible price for firm  $i$  ( $p_i^C$ ) which is offered with positive probability by a credible distribution of prices satisfies:

1.  $p_i^C \leq v$ .
2.  $p_i^C \geq \min \{p_{j \neq i}^C\} + \epsilon$ , for  $\min \{p_{j \neq i}^C\} + \epsilon \leq v$ , otherwise  $p_i^C = v$ .

Where  $p_j^C$  is the lowest credible price being offered by firm  $j$ .



What can we say about the lowest credible price being offered by firms? We argue first that it must be that the lowest (and highest) credible price being offered by firms is the monopoly price,  $v$ . Suppose it were not and that some firm was willing to offer a price strictly less than  $v$ . Call firm  $k$  the firm which offers the lowest credible price,  $\underline{p}_k^c$ , then in order for the other firms' prices to be credible it must be that  $\underline{p}_{i \neq k}^c \geq \underline{p}_k^c + \varepsilon$ , for  $\underline{p}_k^c + \varepsilon \leq v$ , otherwise  $\underline{p}_{i \neq k}^c = v$ . Notice that it cannot be that  $\underline{p}_{i \neq k}^c \geq \underline{p}_k^c + \varepsilon$  since this would mean that firm  $k$ 's lowest credible price was strictly less than all other firm's lowest credible price, contradicting the credibility of  $\underline{p}_k^c$ . The only other possibility is that  $\underline{p}_{i \neq k}^c = v$ . If all firms ( $i \neq k$ ) have only one credible price ( $\underline{p}_{i \neq k}^c = v$ ) then it must be that firm  $k$  also has only one credible price ( $\underline{p}_k^c = v$ ). Contradicting that  $\underline{p}_k^c < v$ .

Finally we argue that this is an equilibrium. If all other firms are offering the monopoly price then if firm  $i$  offers the monopoly price it receives profits  $\pi_i = \frac{v}{N}$ . If it offers a price greater than the monopoly price it gets zero profits, while if it offers a price  $p < v$  it receives profits  $\pi_i = \frac{p}{N} < \frac{v}{N}$ . This is because even if it offers a price substantially less than  $v$ , firm  $i$  will still only sell to  $1/N$  of the consumers, this is because the other  $(N - 1)/N$  consumers reason that such a price is not credible and will be renege upon if indeed they do undertake search in order to find firm  $i$ . QED.

This argument is different to that in Diamond (1971) since it holds for even small numbers of firms. In Diamond's paper, firms are effectively able to commit to prices; this is why he needs to assume a large number of firms so that firms have no incentive to undercut one another. This means that consumers have no incentive to engage in costly search in order to find a lone low price. Another way of thinking about this is that a single firm lowering its price is not enough to induce consumers to search if the number of firms is large. Here, monopoly pricing results, not because reducing one's price fails to induce search, but rather, because the consumers who are considering whether to search, reason that the firm is not being truthful and will renege on the offered price if the consumer ever reaches the firm. Indeed, it could even be

the case that a firm would prefer to be able to commit to a low price and induce search but is unable to as the firm lacks a credible commitment technology.

## 7 WELFARE ANALYSIS

So long as search costs are not too large we have shown that there exists an equilibrium where all consumers will eventually purchase the good. In that sense it is efficient: trade always occurs and it is always optimal for it to occur. The inefficiency arises due to the potential search costs the consumers incur. In particular, whenever the two firms' prices are more than  $\epsilon$  apart, half of the consumers, i.e. those who initially visit the high price firm will search and incur a search cost of  $\epsilon$  which is a pure deadweight loss. Here, we characterise the deadweight loss due to search. Calling the firms' two (realised) prices  $(p, q)$ , the shaded triangles represent the cases where  $p$  and  $q$  are further than  $\epsilon$  apart:

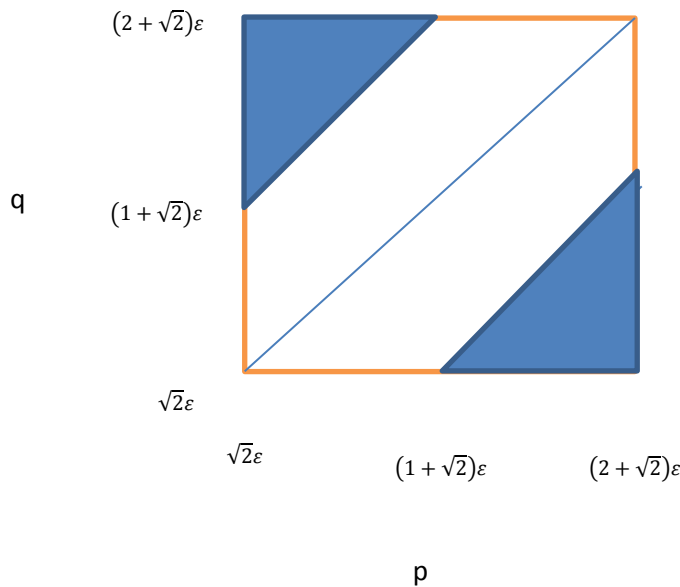

Figure 8: The states of the world in which search occurs.

**Result 7:** *In symmetric equilibrium, the expected welfare loss due to search is:*

$$\left[ -1 - (1 + \sqrt{2})^2 \ln\left(\frac{2}{1 + \sqrt{2}}\right) \right] \epsilon \cong 0.097\epsilon$$

**Proof:** The probability of  $p$  being more than  $\varepsilon$  larger than  $q$  is represented by the bottom right triangle in the diagram; we can find the probability of this event by integrating the densities with the appropriate limits. Let  $\Delta = \Pr[p > q + \varepsilon]$ . We have that

$$\Delta = \int_{(1+\sqrt{2})\varepsilon}^{(2+\sqrt{2})\varepsilon} \int_{\sqrt{2}\varepsilon}^{p-\varepsilon} \frac{(1+\sqrt{2})^2 \varepsilon^2}{(p-\varepsilon)^2 (q+\varepsilon)^2} dq dp = (1+\sqrt{2})^2 \varepsilon^2 \int_{(1+\sqrt{2})\varepsilon}^{(2+\sqrt{2})\varepsilon} \frac{1}{(p-\varepsilon)^2} \int_{\sqrt{2}\varepsilon}^{p-\varepsilon} \frac{1}{(q+\varepsilon)^2} dq dp \quad (5)$$

We can solve explicitly for the final integral in (5)

$$\int_{\sqrt{2}\varepsilon}^{p-\varepsilon} \frac{1}{(q+\varepsilon)^2} dq = \left[ -\frac{1}{q+\varepsilon} \right]_{\sqrt{2}\varepsilon}^{p-\varepsilon} = \frac{1}{(1+\sqrt{2})\varepsilon} - \frac{1}{p}$$

Plugging this into (5) gives

$$\Delta = (1+\sqrt{2})^2 \varepsilon^2 \int_{(1+\sqrt{2})\varepsilon}^{(2+\sqrt{2})\varepsilon} \frac{1}{(p-\varepsilon)^2} \left[ \frac{1}{(1+\sqrt{2})\varepsilon} - \frac{1}{p} \right] dp \quad (6)$$

Expanding the integral in (6) gives

$$\begin{aligned} \int_{(1+\sqrt{2})\varepsilon}^{(2+\sqrt{2})\varepsilon} \frac{1}{(p-\varepsilon)^2} \left[ \frac{1}{(1+\sqrt{2})\varepsilon} - \frac{1}{p} \right] dp &= \frac{1}{(1+\sqrt{2})\varepsilon} \int_{(1+\sqrt{2})\varepsilon}^{(2+\sqrt{2})\varepsilon} \frac{1}{(p-\varepsilon)^2} dp - \int_{(1+\sqrt{2})\varepsilon}^{(2+\sqrt{2})\varepsilon} \frac{1}{p(p-\varepsilon)^2} dp \\ &= \frac{\sqrt{2}}{2(1+\sqrt{2})^2 \varepsilon^2} - \int_{(1+\sqrt{2})\varepsilon}^{(2+\sqrt{2})\varepsilon} \frac{1}{p(p-\varepsilon)^2} dp \end{aligned}$$

Plugging this into (6) gives

$$\Delta = \frac{\sqrt{2}}{2} - (1+\sqrt{2})^2 \varepsilon^2 \int_{(1+\sqrt{2})\varepsilon}^{(2+\sqrt{2})\varepsilon} \frac{1}{p(p-\varepsilon)^2} dp \quad (7)$$

To find the integral in (7) we can split the fraction to be integrated as follows

$$\frac{1}{p(p-\varepsilon)^2} \equiv \frac{A}{p} + \frac{Bp+C}{(p-\varepsilon)^2} \Rightarrow 1 \equiv A(p-\varepsilon)^2 + p(Bp+C)$$

$$\Rightarrow 1 \equiv p^2(A + B) + p(C - 2A\varepsilon) + A\varepsilon^2$$

$$\Rightarrow A + B = 0, \quad C = 2A\varepsilon, \quad A\varepsilon^2 = 1$$

So we have that

$$\frac{1}{p(p - \varepsilon)^2} \equiv \frac{1}{p\varepsilon^2} + \frac{1}{\varepsilon(p - \varepsilon)^2} \left[ 2 - \frac{p}{\varepsilon} \right]$$

Which allows us to express the integral in (7) as:<sup>9</sup>

$$\begin{aligned} \int_d^c \frac{1}{p(p - \varepsilon)^2} dp &= \frac{1}{\varepsilon^2} \int_d^c \frac{1}{p} dp + \frac{1}{\varepsilon} \left[ 2 \int_d^c \frac{1}{(p - \varepsilon)^2} dp - \frac{1}{\varepsilon} \int_d^c \frac{p}{(p - \varepsilon)^2} dp \right] \\ &= \frac{1}{\varepsilon^2} [\ln(p)]_d^c + \frac{1}{\varepsilon} \left[ 2 \left[ -\frac{1}{p - \varepsilon} \right]_d^c - \frac{1}{\varepsilon} \int_d^c \frac{p}{(p - \varepsilon)^2} dp \right] \end{aligned} \quad (8)$$

The integral in (8) can be evaluated as follows

$$\begin{aligned} \int \frac{p}{(p - \varepsilon)^2} dp &= \int \frac{1}{u} du + \varepsilon \int \frac{1}{u^2} du \quad \text{where } u = p - \varepsilon \\ \Rightarrow \int_d^c \frac{p}{(p - \varepsilon)^2} dp &= [\ln(p - \varepsilon)]_d^c + \varepsilon \left[ -\frac{1}{p - \varepsilon} \right]_d^c \end{aligned}$$

Plugging this into (8) gives us that

$$\int_d^c \frac{1}{p(p - \varepsilon)^2} dp = \frac{1}{\varepsilon^2} \left[ \ln \left( \frac{c(d - \varepsilon)}{d(c - \varepsilon)} \right) + \varepsilon \left( \frac{c - d}{(c - \varepsilon)(d - \varepsilon)} \right) \right]$$

Plugging this into (7) and using the correct limits gives us that

$$\Delta = \frac{\sqrt{2}}{2} - (1 + \sqrt{2})^2 \left[ \ln \left( \frac{2\sqrt{2} + 2}{(1 + \sqrt{2})^2} \right) + \frac{1}{2 + \sqrt{2}} \right]$$

---

<sup>9</sup> We have done this for general limits for expositional clarity and later will substitute our particular values for c and d.

$$= -1 - (1 + \sqrt{2})^2 \ln\left(\frac{2}{1 + \sqrt{2}}\right)$$

This is the probability of  $p$  being more than  $\varepsilon$  greater than  $q$ . By symmetry this will also be the probability that  $q$  is more than  $\varepsilon$  greater than  $p$ . So the probability that the difference between the prices  $p$  and  $q$  is larger than  $\varepsilon$  is given by  $2\Delta$ . In this case, exactly half of the consumers will search, thus the unconditional probability that a particular consumer will search is  $\Delta$ , in which case he will pay  $\varepsilon$ . Thus, the expected welfare loss due to search is:  $\Delta\varepsilon$ . QED.

We notice that the probability that search will occur at all,  $2\Delta$ , is independent of  $\varepsilon$ . Intuitively, this is because increasing  $\varepsilon$ , increases the range from which firms' prices can be drawn from i.e. firms' prices must always be within  $2\varepsilon$  of one another. Increasing  $\varepsilon$  makes it more likely that prices will be 'far apart' in absolute terms. Simultaneously, it increases the minimum difference required between the two prices in order for search to occur. These two effects cancel each other out. In other words, an increase in search costs makes the two prices further apart on average but it also increases the required difference between prices in order for search to occur. The value of  $2\Delta$  is approximately 0.2 which means that there is about a 0.2 probability of search in our model. Comparing this to the case where firms price randomly in the interval i.e. randomise uniformly, it is straightforward to show that search would occur with probability 0.25. We can see why search is less likely to occur in our model than when firms price randomly in the interval by inspecting the equilibrium density:

$$f(p_i) = \begin{cases} \frac{(1 + \sqrt{2})\varepsilon}{(p_i + \varepsilon)^2}, & p_i \in [\sqrt{2}\varepsilon, (1 + \sqrt{2})\varepsilon] \\ \frac{(1 + \sqrt{2})\varepsilon}{(p_i - \varepsilon)^2}, & p_i \in [(1 + \sqrt{2})\varepsilon, (2 + \sqrt{2})\varepsilon] \end{cases}$$

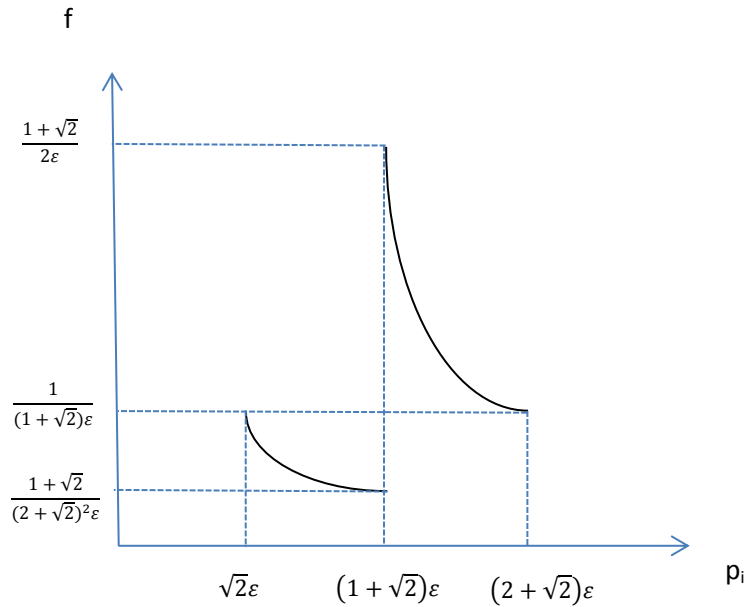

Figure 9: The pdf of the equilibrium price distribution.

A uniform density would be constant over the entire support. In our case, the density is only equal at the ends of the support; if you imagine taking the density from the uniform case and shifting some of the weight from the bottom half  $[\sqrt{2}\epsilon, (1 + \sqrt{2})\epsilon]$  to the top half  $[(1 + \sqrt{2})\epsilon, (2 + \sqrt{2})\epsilon]$ , with more weight being taken from the ‘top of the bottom half’ and placed at the ‘bottom of the top half’. This has the effect of increasing the probability of the two firms’ prices being close to each other. The intuition is clear: having a concentration of weight within an  $\epsilon$  interval increases the chance of both of the prices lying within  $\epsilon$  of one another. In the limit one can imagine moving all of the weight from the bottom half to the top half which would reduce the probability of search to zero.

## 8 CONCLUDING REMARKS

In this chapter we have built a novel model of costly search. The equilibrium of this model has several potentially desirable properties:

1. There is price dispersion in equilibrium. This is desirable since it is consistent with departures from the ‘law of one price’, which we see in most, if not all markets.

2. Equilibrium prices are increasing in the cost of search,  $\epsilon$ . Again this seems intuitive, that markets where consumers are able to search with low costs are characterised by more intense competition between firms. Furthermore, this increase in prices in equilibrium is ‘smooth’ i.e. a small increase in search costs leads to a small increase in prices. This also seems desirable when compared to, for example, Diamond (1971) where you get an extreme discontinuity when moving from zero search costs to positive search costs.
3. Since prices are always bound to be in a  $2\epsilon$ -length interval, the variability of prices is increasing in search costs. That is, when search costs are high it is more likely that firms’ prices will be far apart. This also seems intuitive, that when search costs are high one is more likely to see a large divergence between prices.

Our analysis of the Diamond paradox stressed the importance of commitment in search models. In our model, without commitment, monopoly pricing occurs regardless of the number of firms. With commitment, monopoly pricing only occurs if search costs are sufficiently large. In the next chapter we extend the baseline model presented here by introducing a price comparison website.

# **CHAPTER 2: INTRODUCING A PRICE COMPARISON WEBSITE**

## **1 INTRODUCTION**

A natural extension to modelling costly search is looking at the impact of introducing a price comparison website on markets where search is costly. The reason for doing so is clear: price comparison websites substantially reduce the cost of search; one could even argue that they effectively reduce the cost of search to zero. This is an important observation since we know from Diamond (1971) that while zero search costs can lead to Bertrand competition and push prices down to marginal cost, even small search costs can weaken competitive pressures substantially and lead to monopoly pricing. Furthermore, price comparison websites are now pervasive and consumers are increasingly likely to make purchases through them. Indeed, a July 2011 report by market research firm Mintel finds that in the UK ‘Almost half (46%) of all internet users have researched motor insurance through a price comparison site with the majority of these researchers (80%) having gone on to buy cover through this channel.’

### **1.1 RELATIONSHIP TO THE LITERATURE**

The literature on price comparison websites, search engines and other intermediaries is by its nature relatively recent but is growing substantially. This reflects the significance and prevalence of such intermediaries in the marketplace and the impact in general the internet has had on the way consumers and firms find each other and trade. Levin (2011) and Ellison and Ellison (2005) provide nice reviews on the expected and unexpected impact of the internet on economics research. To give some idea of the scale of such online intermediaries, Google, a firm whose primary business is as a search engine and therefore an intermediary between consumers and firms was worth around \$300 billion in August 2013. Baye and Morgan (2000, 2001) are two early influential papers which analyse the impact of price comparison websites (which they call ‘gatekeepers’) on consumer and firm behaviour. What is different about their paper and the one



presented here is that in their paper, firms pay a fixed ‘advertising fee’ and consumers pay a fixed ‘subscription fee’ in order to use the services of the gatekeeper regardless of how many sales or purchases are made by this means. It is not clear that this is how these markets work in practice. In fact, it is rare to find a comparison site which charges consumers explicitly in order to search for prices. Similarly, for the kinds of comparison sites we are thinking of (where a consumer can find a list of prices from different firms for the same product), the standard pricing structure is that the comparison site will charge a commission for each sale which is made through their site, here is a quote from a major comparison site:

*‘We don't charge our customers for using our service and we do not add fees or commissions to the prices you compare; instead we make money by charging our partners a small fee once a sale has been made.’<sup>10</sup>*

Of course, this is only half true. The quote implies to the unsuspecting consumer that they are not paying for the services of the site, but the commission fee acts much like a tax. A basic understanding of tax incidence tells us that formal incidence and effective incidence are two different things.

Another strand of the literature focuses on the market impact of search engines, such as Google or Bing, where consumers enter a search query (not necessarily to find an item to purchase) and then are presented with a list of results in some order determined by the search engine. Firms often make some kind of payment to the search engine to be listed prominently. The literature looks at two main payment structures: one is cost-per-impression (CPM), where a fixed lump-sum payment is made regardless of the number of times a consumer ‘clicks through’ to your link; and the other is cost-per-click (CPC), where a payment is made for each click a consumer makes to your link. Some recent papers in this vein include Chen and He (2011) and Eliaz and Speigler (2011) which both look at the use of sponsored links by search engines; Baye et al. (2011) look at whether an intermediary would prefer to use CPM or CPC pricing; while Armstrong and Zhou (2011) look at a model where firms can advertise either on a lump-sum or commission basis. Our model is closer to CPC rather than CPM since firms only pay a

---

<sup>10</sup> Source: <http://www.gocompare.com/about/customer-promise/>

commission to the referring site if a sale is made, although it is still somewhat different to CPC since with CPC a payment is made when a consumer clicks through, regardless of whether or not a sale is made.

Finally, we note the similarity of our model to Varian's classic (1980) paper on sales. In his paper, some consumers are informed about the distribution of prices and so need not search – they are able to purchase from the lowest price firm. While other consumers are uninformed, they simply purchase at the first store that they randomly arrive at, so long as the price offered is below their reservation price. This leads to a tractable elegant model which can explain price dispersion. However, the uninformed consumers in his model can only be thought to be optimising if they have sufficiently high search costs which mean that search is never worthwhile. One way of thinking about the model presented in this chapter is as a generalisation of Varian (1980), when search costs are relatively small compared to the valuation of the good being searched for. This means that uninformed consumers may now find it worthwhile to search if they arrive at a relatively expensive store. In this chapter, 'informed' refers to being informed about the existence of (as well as having the requisite knowledge to use) the price comparison website. We retain our modelling assumption from Chapter 1 that uninformed consumers know the realisation of the draws from firms' mixed strategies.

## **1.2 THE STRUCTURE OF THE CHAPTER**

In this chapter we introduce a price comparison website (PCW) which neither charges firms nor consumers to use its services (in Chapter 3 we introduce commission fees). In Section 2 we outline the general model. To avoid the model collapsing into Bertrand competition, only proportion  $\lambda$  of consumers are aware of the existence of the price comparison website. In Section 3 we restrict firms to playing only pure strategies with a continuous action space. We find that there are no rationalisable pure strategies in this case; an important corollary is that there does not exist a pure-strategy Nash equilibrium. In Section 4 we consider the case where firms can only offer discrete prices and play pure strategies. We find that there is no equilibrium but that there does exist a set of rationalisable pure strategies. The set of rationalisable strategies

depends on the proportion of informed consumers. Section 5 contains the substantive result of this chapter, here we consider the case where firms can play mixed strategies and offer continuous prices. We find that if the proportion of informed consumers is sufficiently large then there exists a symmetric mixed strategy Nash equilibrium. To aid the reader, we reproduce the substantive result here:

**Result 5:** For  $\lambda > \frac{1}{5}[1 - \lambda^2 - 3\lambda^3]$  there is a symmetric mixed strategy Nash equilibrium of the game where both firms offer prices on the support  $[\frac{1-\lambda}{2\lambda}\varepsilon, \frac{1+\lambda}{2\lambda}\varepsilon]$ . The equilibrium distribution of prices is given by the cumulative distribution function:

$$F(p_i) = \frac{1 + \lambda}{2\lambda} \left[ 1 - \frac{(1 - \lambda)\varepsilon}{2\lambda p_i} \right].$$

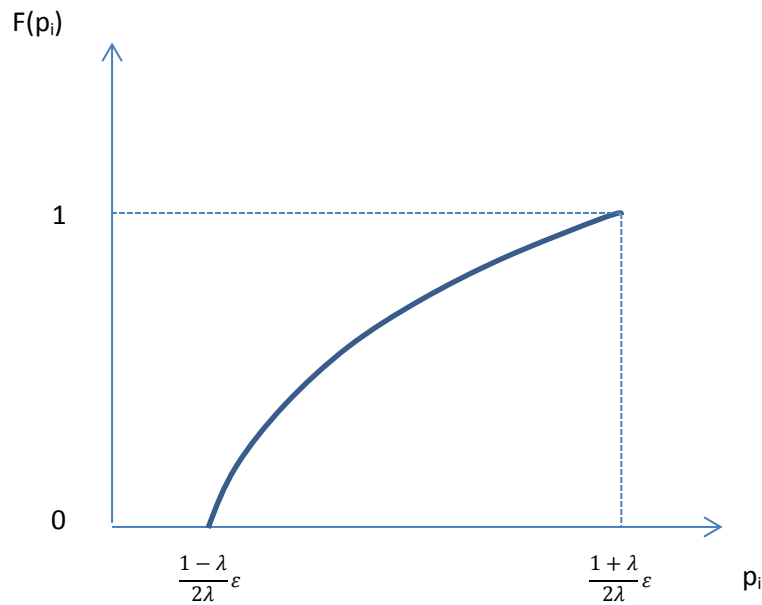

Figure 1: The CDF of the symmetric mixed strategy Nash equilibrium.

Firms make profits in equilibrium of  $\pi = \frac{(1-\lambda^2)\varepsilon}{4\lambda}$ .

In Section 6 we end the chapter by considering the links between the model presented here and Bertrand competition; as well as making comparisons with the baseline model presented in Chapter 1.

## 2 THE MODEL

In this section we outline the model and the timing of the decisions of consumers and firms. We discuss what we mean by a price comparison website and make clear the assumptions that we are making in modelling it. The model is a generalisation of the model presented in Chapter 1. There is again a unit mass of consumers searching for the lowest price for one unit of a good which they value at  $v = 1$ . Uninformed consumers do not know the prices at any given store until they visit it. They do however know the *realised* distribution of prices. Informed consumers know the realisation of the prices *and* which store is offering which price. It is important to stress that consumers' knowledge of the realisation of prices is not just something which occurs in equilibrium in our model. Rather, it is an integral part of the model and is always the case, whether we are analysing equilibria or not. Visiting a store incurs a search cost  $\epsilon$  for the uninformed consumer. Informed consumers incur no search costs. Firms can produce the good costlessly. This is all common knowledge.

### *Timing of the game*

1.  $N$  firms simultaneously each choose a distribution  $F_i$  ( $i = 1, \dots, N$ ) from which their price will be drawn.
2. Nature draws a single price  $p_i$  from each distribution  $F_i$ .
3. The uninformed consumers are presented with the collection of prices  $(p_1, \dots, p_N)$  but they do not know which price is associated with which firm.
4. Informed consumers visit the price comparison website and are informed of the full realisation of prices and which price is associated with which firm.
5. Uninformed consumers engage in costly search (or not). While informed consumers are able to purchase at any of the stores without incurring any search costs.

### 2.1 INTRODUCING A FREE PRICE COMPARISON WEBSITE

The price comparison website works by essentially collecting all the information about which firm is offering which price and then displays it for free to the informed consumers. Since we

have assumed that it is free to use – for both consumers and firms – a firm cannot be made worse off by using the service (and maybe made better off). Thus, we assume that all firms will post their price on the site. Notice however, that while for any individual firm, listing on the comparison site weakly dominates not listing (strictly dominates if there is some probability of making additional sales on the comparison site). In aggregate, firms may prefer the baseline equilibrium where no comparison site exists to the equilibrium which prevails when there is a comparison site. That is to say, holding the listing behaviour of a firm’s competitors fixed it makes sense for that firm to list. However, the state of the world where all firms list may be disliked by each firm compared to the state of the world where no firm posts their price on the site. Similarly, an informed consumer cannot be made worse off by deciding to view the information provided by the site (and may be better off). Thus, we assume that all of the informed consumers begin the search process by viewing the information available on the site. Since all firms use the site, this also marks the end of the informed consumers’ search.

We focus on the two-firm case. In this chapter we assume that the price comparison website charges no fees to either firms or consumers and always lists both of the prices. A proportion  $\lambda$  of consumers know about the site, can search the prices (and identify which firm charges which price) and order the product without incurring any search costs. From the point of view of an informed consumer, this looks much like Bertrand competition. A proportion  $1-\lambda$  of consumers do not know about the site and face the search problem described in Chapter 1. We find that (i) in the pure-strategy continuous-action game there are no rationalisable pure-strategies (ii) in the pure-strategy discrete-action game there are no equilibria but there are typically rationalisable pure strategies (iii) in the mixed-strategy continuous-action game there is a symmetric Nash equilibrium where each firm randomises over an interval with a support of length  $\epsilon$  for sufficiently large  $\lambda$ . In this equilibrium, the informed customers just buy at the cheapest price and if the two firms offer the same price, then the market is split equally just like in Bertrand competition. The uninformed consumers behave as before: they randomly arrive at one of the stores, learn the two prices and consider whether they should buy at the current store or pay a search cost to buy from the other store.

It is important to consider whether firms can offer different prices to the two groups of consumers. If they can, then the equilibrium is straightforward: firms engage in Bertrand competition for the informed consumers. This pushes equilibrium prices down to marginal cost for the informed consumers, while the baseline equilibrium in Chapter 1 is played by firms when competing for the uninformed consumers. The less straightforward case is where firms are forced to charge the same price to both groups of consumers. One could think of this as where there is no formal agreement between the comparison site and the firm, the comparison site is simply offering information about the prices available in the market.<sup>11</sup> Indeed, in this chapter the comparison site is a benevolent actor. It does not care about making profits; it is simply freely providing information about prices to informed consumers. We will relax this assumption in Chapter 3.

As we alluded to in the introduction, this model has much in common with Varian (1980). In our model the comparison site is the technology which allows the informed consumers to always purchase at the lowest price firm without incurring any search costs. Where our model differs is that uninformed consumers, while still randomly arriving at a store, may or may not choose to purchase there. Instead an uninformed consumer may prefer to search. Furthermore, since he knows the realisation of the prices which are being offered, the decision whether to search or not is relatively simple and in the two-firm case is very simple.

### **3 PURE STRATEGIES AND CONTINUOUS PRICES.**

In this section we analyse firms' strategic considerations in this context. To do this we restrict them to only playing pure-strategies; however, they can offer any price in a continuous interval. We find that not only are there no pure-strategy Nash equilibrium but when restricted to pure-strategies there will not exist a rationalisable strategy available to firms. We show this by arguing that there will only be two candidates for a best response, one of which is the empty set. We

---

<sup>11</sup> Some possible justifications for the existence of such a service are (i) the service could make revenues from advertising (ii) it could be a government initiative in order to increase competition, indeed, a scheme to automatically place elderly energy customers on the cheapest available tariff has been proposed by politicians in the UK: <http://www.guardian.co.uk/uk/2012/feb/26/energy>

then consider different cases of  $\lambda$  (the proportion of informed consumers) and show that for every case, the iterative deletion of strategies which are never a best response always leaves us with the empty set. That is, when firms are restricted to playing only pure strategies (i.e. when they are asked to choose a distribution from which their price will be drawn, they can only offer a degenerate distribution) then not only are there no equilibria, but there are no strategies which are rationalisable.

### 3.1 FIRMS' BEST RESPONSES

In this subsection we begin by fixing the price of firm  $j$  and then consider how the two firms will share the market depending on the price that firm  $i$  offers. Next, we argue that there are only two possible candidates for a best response. Characterising these, we look at three different cases and show that in each case the iterative deletion of strategies which are never a best response leads to the empty set. Since these three cases exhaust all possibilities our result is that there is no rationalisable strategy when firms are restricted to pure-strategies and therefore no pure-strategy Nash equilibrium.

Consider how a firm would best respond to an action taken by its competitor. Suppose that firm  $j$  is offering the price  $p_j$ . The diagram below shows what proportion of the customers firm  $i$  can expect to attract if he offers the price  $p_i$  in different ranges:

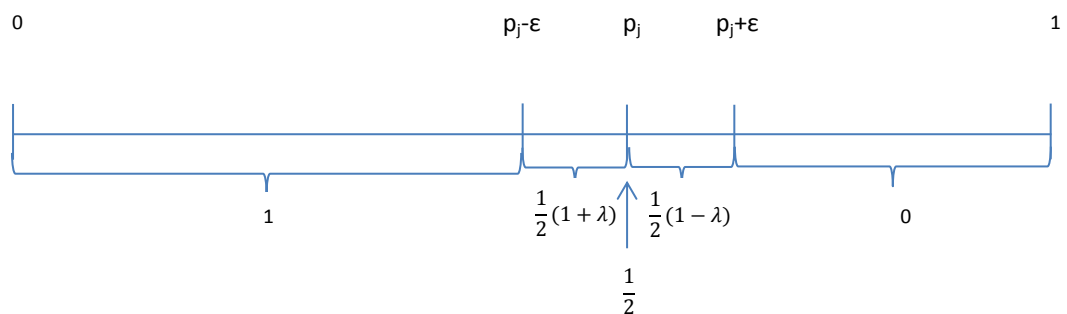

Figure 2: The proportion of consumers firm  $i$  can expect to sell to at different prices.

That is:

If  $p_i < p_j - \varepsilon$ , all of the informed consumers would purchase from firm i because it is cheaper, and all of the uninformed consumers would purchase from firm i, either because they initially visited firm i, or because they initially visited firm j and then saw that firm i was more than  $\varepsilon$  cheaper than firm j.

If  $p_i \in [p_j - \varepsilon, p_j)$ , all of the informed consumers and half of the uninformed consumers buy from firm i. This is because only those uninformed consumers who initially visit firm i will purchase from there. In total, the proportion  $\lambda + \frac{1}{2}(1 - \lambda) = \frac{1}{2}(1 + \lambda)$  of consumers will buy from firm i.

If  $p_i = p_j$ , then both firms will split the market equally. Half the informed and half the uninformed consumers purchase from each store.

If  $p_i \in (p_j, p_j + \varepsilon]$ , then none of the informed consumers will purchase from firm i and half of the uninformed consumers will purchase from firm i. This gives firm i a total of  $\frac{1}{2}(1 - \lambda)$  of the consumers.

If  $p_i > p_j + \varepsilon$ , then none of the informed consumers (firm j is cheaper than firm i) and none of the uninformed consumers (firm j is more than  $\varepsilon$  cheaper than firm i) will purchase from firm i. Notice that within each region the proportion of customers that firm i attracts is constant, therefore within each region the highest possible price dominates all other prices in that region.

Clearly in this model it will never be a best response to offer a price above  $p_j + \varepsilon$ , since – in a similar way to offering a price higher than your competitor in Bertrand – this will result in zero profits. If firm i offers a price  $p_i \in (p_j, p_j + \varepsilon]$ , it will sell to proportion  $\frac{1}{2}(1 - \lambda)$  of the consumers, thus  $p_i = p_j + \varepsilon$  does strictly better than all other prices in the interval  $(p_j, p_j + \varepsilon]$ . If firm i matches firm j's price ( $p_i = p_j$ ), then we know that it will be able to sell to half of the consumers. However, unless  $p_j = 0$  such a strategy will be strictly dominated by offering a price slightly below  $p_j$ , which would allow firm i to sell to all of the informed consumers.



Furthermore, when  $p_j = 0$ , matching the opponent's price will be dominated by offering the price  $p_i = \varepsilon$ . Thus we rule out firm i best responding by matching firm j's price.

As for offering a price in the interval  $[0, p_j - \varepsilon)$  or the interval  $[p_j - \varepsilon, p_j)$  things are again complicated by the fact that whatever price firm i chooses in these intervals, there is some other slightly higher price which yields it strictly higher profits. As we pointed out before, a similar thing happens in Bertrand competition when firm j offers a price  $p_j$  strictly greater than marginal cost. That is, there is no price that firm i can offer which is a best response to  $p_j$ . The reason for this is that  $p_i > p_j$  cannot be a best response since firm i receives zero profits, while offering  $p_i = p_j$  yields strictly positive profits. However,  $p_i = p_j$  also cannot be a best response since offering a price a very small amount below  $p_j$  will allow firm i to take the entire market and this must do better than matching firm j's price. So, if there is to be a best response to  $p_j$  it must be some price  $p_i < p_j$ . However, whatever price firm i picks such that  $p_i < p_j$  there is always some other price in the interval  $(p_i, p_j)$  which does strictly better. Thus in Bertrand competition the set of best responses to one's competitor offering a price strictly greater than marginal cost is the empty set. In a similar way, in our model there cannot be a best response in the interval  $[0, p_j - \varepsilon)$  or in the interval  $[p_j - \varepsilon, p_j)$ . This leaves firm i with two possible candidates for a best response to  $p_j$ :<sup>12</sup>

1.  $p_i = p_j + \varepsilon$ . Which we call 'exploit' i.e. the highest price which retains half of the uninformed consumers.
2.  $\emptyset$ , the empty set i.e. no best response.

That is to say, when  $p_i = p_j + \varepsilon$  does better than all other possible responses to  $p_j$ , clearly it will be the best response. That much is trivial, however what is less trivial is that when there exists at least one price which does better than  $p_i = p_j + \varepsilon$ , then there will be no best response. To work out when the set of best responses is going to be empty we consider that firm i offering a price just less than  $p_j - \varepsilon$  will be able to sell to all the consumers and will yield a profit arbitrarily close to, but less than,  $p_j - \varepsilon$ . We will call this strategy 'steal'. Similarly, we consider that firm i could

---

<sup>12</sup> We are assuming that  $p_j + \varepsilon \leq 1$ .

'just undercut' firm  $j$  and take all of the informed consumers yielding a profit arbitrarily close to, but less than  $\frac{1}{2}(1 + \lambda)p_j$ . Associated profits are then:

(E)xploit, offering the highest price which retains half of the uninformed consumers:

$$\pi_i(E) = \frac{1}{2}(1 - \lambda)(p_j + \varepsilon)$$

(S)teal, offering a price which attracts all of the consumers, informed and uninformed, allows firm  $i$  to make a profit arbitrarily close to, but less than:

$$\pi_i(S) = p_j - \varepsilon$$

(J)ust undercut, offering a price which attracts all of the informed consumers allows firm  $i$  to make a profit arbitrarily close to, but less than:

$$\pi_i(J) = \frac{1}{2}(1 + \lambda)p_j$$

Characterising the conditions under which the three possible responses are preferred to one another, gives us conditions on  $p_j$ :

$$\pi_i(S) \geq \pi_i(J)$$

$$p_j \geq \frac{2\varepsilon}{1 - \lambda}$$

$$\pi_i(S) \geq \pi_i(E)$$

$$p_j \geq \frac{3 - \lambda}{1 + \lambda} \varepsilon$$

$$\pi_i(J) \geq \pi_i(E)$$

$$p_j \geq \frac{1 - \lambda}{2\lambda} \varepsilon$$

Attempting to sort the different cases looks like a daunting task, however it is made much easier when we notice that when  $\lambda > 3 - 2\sqrt{2}$ :

$$\frac{2\varepsilon}{1 - \lambda} > \frac{3 - \lambda}{1 + \lambda} \varepsilon > \frac{1 - \lambda}{2\lambda} \varepsilon$$

Similarly, when  $\lambda < 3 - 2\sqrt{2}$ :

$$\frac{2\varepsilon}{1 - \lambda} < \frac{3 - \lambda}{1 + \lambda} \varepsilon < \frac{1 - \lambda}{2\lambda} \varepsilon$$

This allows us to give firm  $i$ 's best response for all possible  $p_j$  in three cases (i)  $\lambda > 3 - 2\sqrt{2}$ , (ii)  $\lambda < 3 - 2\sqrt{2}$  and (iii)  $\lambda = 3 - 2\sqrt{2}$ .

### 3.2 CASE (i) $\lambda > 3 - 2\sqrt{2}$ :

In this case, there is a relatively large number of informed consumers. We proceed by considering what a firm's best response would be when his opponent offered prices in different regions:

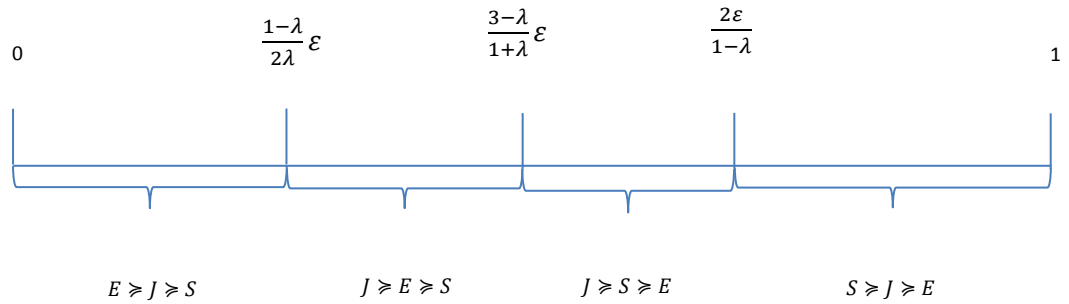

Figure 3: How a firm ranks potential best responses depending on the price offered by their competitor.

The figure above tells us that when firm  $j$  offers a price in the interval  $\left[0, \frac{1-\lambda}{2\lambda}\varepsilon\right]$  firm  $i$  prefers to ‘(E)xploit’ rather than ‘(J)ust undercut,’ which it prefer to ‘(S)teal’. In this case its best response is well defined. Recall that for those prices of firm  $j$  where  $\pi_i(E)$  is greater than  $\pi_i(S)$  and  $\pi_i(J)$  we can say that firm  $i$ 's best response is to ‘exploit’ i.e. to offer the price  $BR_i(p_j) = p_j + \varepsilon$ . However, in those cases where either  $\pi_i(S)$  or  $\pi_i(J)$  yields the highest profits there will be no best response to  $p_j$ . This is because there will be at least one price in the interval  $[0, p_j - \varepsilon)$  or in the interval  $[p_j - \varepsilon, p_j)$  which will do strictly better than  $p_i = p_j + \varepsilon$ . Furthermore, for any price in either of these two intervals one can always find a higher price in the interval which yields greater profits. Thus, inspecting Figure 3 we see that if firm  $j$  offers a price in the interval  $\left[0, \frac{1-\lambda}{2\lambda}\varepsilon\right]$ , firm  $i$ 's best response is to ‘exploit’. If firm  $j$  offers any other price, then firm  $i$  has no best response. This leads us to our first lemma.

**Lemma 1:** *When  $\lambda > 3 - 2\sqrt{2}$ , and firms are restricted to pure strategies and can offer any price in the interval  $[0, 1]$  then the set of rationalisable pure strategies is the empty set  $\emptyset$ .*

**Proof:** The rationalisable strategies are those which survive the iterative deletion of strategies which are never a best response. Beginning with allowing firms to offer any price in the interval  $[0, 1]$ , the best response to a price in the interval  $\left[0, \frac{1-\lambda}{2\lambda}\varepsilon\right]$  will be a price in the interval  $\left[\varepsilon, \frac{1+\lambda}{2\lambda}\varepsilon\right]$ . This is because in this region, ‘exploit’ is the best response. While for those prices in the interval  $\left(\frac{1-\lambda}{2\lambda}\varepsilon, 1\right]$  there exists no best response. This is because in this region either ‘just undercut’ or ‘steal’ do better than ‘exploit’. Thus, prices outside of the interval  $\left[\varepsilon, \frac{1+\lambda}{2\lambda}\varepsilon\right]$  are never a best response to any price in the interval  $[0, 1]$  and can be deleted. Continuing this process, the best responses to prices in the interval  $\left[\varepsilon, \frac{1-\lambda}{2\lambda}\varepsilon\right]$  are those prices in the interval  $\left[2\varepsilon, \frac{1+\lambda}{2\lambda}\varepsilon\right]$ . While for those prices in the interval  $\left(\frac{1-\lambda}{2\lambda}\varepsilon, \frac{1+\lambda}{2\lambda}\varepsilon\right]$  there exists no best response. We can now delete those prices in the interval  $[\varepsilon, 2\varepsilon)$  since they will never be a best response. Iterating this process, one will eventually delete all prices in the interval  $[0, 1]$ . QED.

Thus, not only are there no equilibria in this case, there does not exist a rationalisable strategy.

### 3.3 CASE (ii) $\lambda < 3 - 2\sqrt{2}$ :

A similar figure which depicts a firm’s preferences over the different best-response options when its opponent offers prices in different regions is shown below. Notice that now, ‘just undercut’ is not the most preferred response to any price offered by a competitor. Intuitively this makes sense, as in this case the number of informed consumers is relatively small. Since ‘just undercutting’ is only successful at attracting informed consumers, we should not be surprised that ‘just undercut’ looks relatively unattractive in this case compared with in case (i).

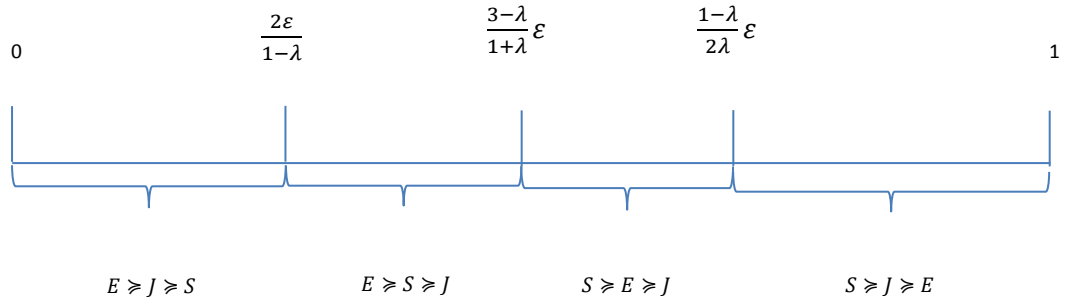

**Figure 4:** How a firm ranks potential best responses depending on the price offered by their competitor.

For example, by inspecting Figure 4 we see that if firm  $j$  offers a price in the interval  $\left[0, \frac{3-\lambda}{1+\lambda}\varepsilon\right]$  then firm  $i$ 's best response is to 'exploit'. That is, to offer a price  $\varepsilon$  greater. If firm  $j$  offers any other price, firm  $i$  has no best response. This is for the now familiar reason that for any price a firm chooses which is sufficiently low to 'steal' all of the customers from its competitor, there exists some price slightly higher which does the same and yields strictly greater profits. This leads us to our next lemma.

**Lemma 2:** *When  $\lambda < 3 - 2\sqrt{2}$ , and firms are restricted to pure strategies and can offer any price in the interval  $[0, 1]$  then the set of rationalisable pure strategies is the empty set  $\emptyset$ .*

**Proof:** The rationalisable strategies are those which survive the iterative deletion of strategies which are never a best response. Beginning with allowing firms to offer any price in the interval  $[0, 1]$  it is easy to see that the best responses to prices in the interval  $\left[0, \frac{3-\lambda}{1+\lambda}\varepsilon\right]$  are those prices in the interval  $\left[\varepsilon, \frac{4}{1+\lambda}\varepsilon\right]$ . While for those prices in the interval  $\left(\frac{3-\lambda}{1+\lambda}\varepsilon, 1\right]$  there exists no best response. Thus, prices outside of the interval  $\left[\varepsilon, \frac{4}{1+\lambda}\varepsilon\right]$  are never a best response and can be deleted. Continuing this process, the best responses to prices in the interval  $\left[\varepsilon, \frac{3-\lambda}{1+\lambda}\varepsilon\right]$  are those prices in the interval  $\left[2\varepsilon, \frac{4}{1+\lambda}\varepsilon\right]$ . While for those prices in the interval  $\left(\frac{3-\lambda}{1+\lambda}\varepsilon, \frac{4}{1+\lambda}\varepsilon\right]$  there exists no best response. We can now delete those prices in the interval  $[\varepsilon, 2\varepsilon)$  since they will never be a best response. It is easy to see that iterating this process will delete all prices in the interval  $[0, 1]$ . QED.

Again, we see that there is not a single rationalisable strategy in this case when firms are restricted to playing pure strategies. Finally, we look at the knife-edge case where the proportion of informed consumers is exactly  $\lambda = 3 - 2\sqrt{2}$ .

### 3.4 CASE (iii) $\lambda = 3 - 2\sqrt{2}$ :

This is the knife-edge case where all three critical values are equal to one another:

$$\frac{2\varepsilon}{1-\lambda} = \frac{3-\lambda}{1+\lambda}\varepsilon = \frac{1-\lambda}{2\lambda}\varepsilon$$

Now, the preferred response to an opponent pricing in different regions yields the diagram below. Notice that there are now only two regions since the ‘interior’ regions (i.e. those prices between  $\frac{2\varepsilon}{1-\lambda}$  and  $\frac{1-\lambda}{2\lambda}\varepsilon$ ) have now collapsed. To see this more clearly take either Figure 3 or Figure 4 and delete the mid-section between  $\frac{2\varepsilon}{1-\lambda}$  and  $\frac{1-\lambda}{2\lambda}\varepsilon$ . One will be left with something like the diagram below:

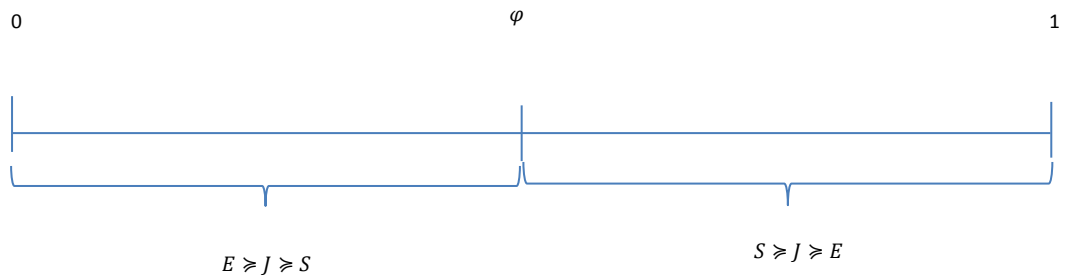

Figure 5: How a firm ranks potential best responses depending on the price offered by their competitor.

Where:

$$\varphi = \frac{2\varepsilon}{1-\lambda} = \frac{3-\lambda}{1+\lambda}\varepsilon = \frac{1-\lambda}{2\lambda}\varepsilon$$

Notice that for prices in the interval  $[0, \varphi]$  the best response is to ‘exploit’ while for prices in the interval  $(\varphi, 1]$  there exists no best response. A similar analysis leads us to the following conclusion:

**Lemma 3:** *When  $\lambda = 3 - 2\sqrt{2}$ , firms are restricted to pure strategies and can offer any price in the interval  $[0, 1]$  then the set of rationalisable pure strategies is the empty set  $\emptyset$ .*

**Proof:** The rationalisable strategies are those which survive the iterative deletion of strategies which are never a best response. Beginning with allowing firms to offer any price in the interval  $[0, 1]$  it is easy to see that the best responses to prices in the interval  $[0, \varphi]$  are those prices in the interval  $[\varepsilon, \varphi + \varepsilon]$ . While for those prices in the interval  $(\varphi, 1]$  there exists no best response. Thus prices outside of the interval  $[\varepsilon, \varphi + \varepsilon]$  are never a best response and can be deleted. Continuing this process, the best responses to prices in the interval  $[\varepsilon, \varphi]$  are those prices in the interval  $[2\varepsilon, \varphi + \varepsilon]$ . While for those prices in the interval  $(\varphi, \varphi + \varepsilon]$  there exists no best response. We can now delete those prices in the interval  $[\varepsilon, 2\varepsilon)$  since they will never be a best response. It is easy to see that iterating this process will delete all prices in the interval  $[0, 1]$ . QED.

We can now state our result.

**Result 1:** *Whatever the proportion of informed consumers  $\lambda \in [0,1]$ , when firms are restricted to pure strategies and can offer any price in the interval  $[0, 1]$  the set of rationalisable strategies is the empty set  $\emptyset$ .*

**Proof:** This follows trivially from Lemmas 1 – 3. QED.

This result parallels Result 1 in Chapter 1 since it says that in the game where firms can only play pure strategies, and their strategy set is a continuous interval of prices, there does not exist a single rationalisable strategy. Since Nash equilibria are a subset of rationalisable strategies, we have:

**Corollary 1:** *Whatever the proportion of informed consumers  $\lambda \in [0,1]$ , when firms are restricted to pure strategies and can offer any price in the interval  $[0, 1]$  there does not exist a Nash equilibrium of the game.*

So to summarise, in this section we have shown that there is no pure-strategy Nash equilibrium. Furthermore, when firms are restricted to playing pure-strategies and the action space is continuous, not only does there not exist a Nash equilibrium but also there are no rationalisable

strategies either. Nevertheless, in this section we have begun to understand the strategic incentives that firms face in this framework.

## 4 PURE STRATEGIES AND DISCRETE PRICES

In this section we restrict our attention to the case where firms can only play pure-strategies and their action space is discrete. This allows us to analyse the cycles in prices which result from the tensions firms face between, on the one hand, wanting to undercut their competitor, and on the other, charging a high price to few consumers. I claim that the reason why there are no rationalisable strategies in the pure-strategy game presented in Section 3 is that firms have a continuous action space. Due to this, when firms would prefer to respond to their competitor's price by 'just undercutting' or 'stealing' rather than 'exploiting', whichever price they chose there was always some price slightly higher which did better. This meant that there was no best response for firm  $i$  to firm  $j$  offering certain prices.

To find firm  $i$ 's best response to firm  $j$ 's price we note (keeping in mind our earlier analysis) that there are now three possible candidates for a best response to  $p_j$ . Recall that in Section 3, the responses 'steal' and 'just undercut' could not be considered best responses since they were not well-defined. However, now, they will be well-defined since we have discretised the action space. Enumerating the three possible best responses, we have:<sup>13</sup>

1.  $p_i = p_j + \epsilon$ . Which we call 'exploit' i.e. the highest price which retains half of the uninformed consumers.
2.  $p_i = p_j - \epsilon - \delta$ . Which we call 'steal' i.e. the highest price which attracts all of the consumers whether informed or uninformed.
3.  $p_i = p_j - \delta$ . Which we call 'just undercut' i.e. the highest price which attracts all of the informed consumers.

To see this more clearly, the figure below shows the proportions of consumers a firm can expect to sell to, according to how it responds to its opponent's price:

---

<sup>13</sup> Where  $\delta$  is the length of the interval between one discrete price and the next.



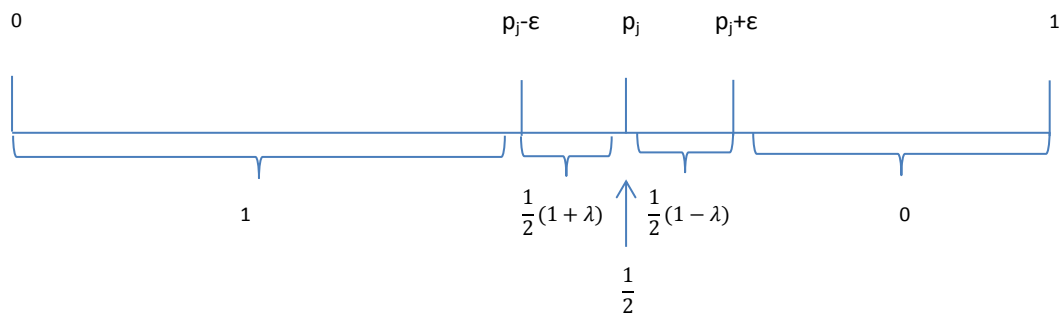

Figure 6: The proportion of consumers firm  $i$  can expect to sell to at different prices.

The potential best-responses are the highest prices in each region, that is, they do better than all other prices in that region against  $p_j$ . We ignore the possibility that offering the same price as your competitor could be a best response. We justify this on the grounds that if we choose  $\delta$  to be sufficiently small then at least one of ‘just undercut’ or ‘exploit’ will do strictly better. To see this, first consider the circumstances in which (J)ust undercut does better than (M)atch:

$$\pi_i(J) = \frac{1}{2}(1 + \lambda)(p_j - \delta) > \frac{1}{2}p_j = \pi_i(M)$$

Which is equivalent to requiring that:

$$p_j > \left(\frac{1 + \lambda}{\lambda}\right)\delta$$

Next, consider the circumstances in which (E)xploit does better than (M)atch:

$$\pi_i(E) = \frac{1}{2}(1 - \lambda)(p_j + \varepsilon) > \frac{1}{2}p_j = \pi_i(M)$$

Which is equivalent to requiring that:

$$p_j < \left(\frac{1 - \lambda}{\lambda}\right)\varepsilon$$

Suppose that we are in the case where  $p_j < \left(\frac{1+\lambda}{\lambda}\right)\delta$  i.e. where ‘match’ does better than ‘just undercut’, can we say that ‘exploit’ will do better than ‘match’? We know that for this to be the case we need that  $p_j < \left(\frac{1-\lambda}{\lambda}\right)\varepsilon$ , we can ensure that this will be the case so long as  $\left(\frac{1-\lambda}{\lambda}\right)\varepsilon > \left(\frac{1+\lambda}{\lambda}\right)\delta$ . Which is equivalent to requiring that  $\delta$  be chosen such that:

$$\delta < \left(\frac{1-\lambda}{1+\lambda}\right)\varepsilon$$

Since we are free to choose  $\delta$ , we always assume that it is chosen so that it is sufficiently small to satisfy the condition above. Since we no longer have to worry about the existence of a best-response, associated profits in each case to firm  $i$  when its opponent offers the price  $p_j$  are no longer an approximation and can be stated exactly:

$$(E)_{\text{xploit}}: \pi_i(E) = \frac{1}{2}(1-\lambda)(p_j + \varepsilon)$$

$$(S)_{\text{teal}}: \pi_i(S) = p_j - \varepsilon - \delta$$

$$(J)_{\text{ust undercut}}: \pi_i(J) = \frac{1}{2}(1+\lambda)(p_j - \delta)$$

Characterising the conditions under which the three possible responses are preferred to one another tells us:

$$\begin{array}{lll} \pi_i(S) \geq \pi_i(J) & \pi_i(S) \geq \pi_i(E) & \pi_i(J) \geq \pi_i(E) \\ p_j \geq \frac{2\varepsilon}{1-\lambda} + \delta & p_j \geq \frac{(3-\lambda)\varepsilon + 2\delta}{1+\lambda} & p_j \geq \frac{(1-\lambda)\varepsilon + (1+\lambda)\delta}{2\lambda} \end{array}$$

Unsurprisingly, for small  $\delta$  (so long as  $\lambda$  is not close to zero) these tend to the same cut-offs as in the continuous case. There is very little to be gained in using the exact cut-offs here but they add to the complexity of the problem substantially. Therefore we will use the approximation that for small  $\delta$ :

$$\pi_i(S) \geq \pi_i(J)$$

$$p_j \geq \frac{2\varepsilon}{1-\lambda}$$

$$\pi_i(S) \geq \pi_i(E)$$

$$p_j \geq \frac{3-\lambda}{1+\lambda} \varepsilon$$

$$\pi_i(J) \geq \pi_i(E)$$

$$p_j \geq \frac{1-\lambda}{2\lambda} \varepsilon$$

To make our lives easier we always assume that critical values can be expressed as an exact integer multiple of  $\delta$ .<sup>14</sup> Again, we go through the different cases. Recalling that when  $\lambda > 3 - 2\sqrt{2}$ , it is the case that:

$$\frac{2\varepsilon}{1-\lambda} > \frac{3-\lambda}{1+\lambda} \varepsilon > \frac{1-\lambda}{2\lambda} \varepsilon$$

And similarly, that when  $\lambda < 3 - 2\sqrt{2}$ , it is the case that:

$$\frac{2\varepsilon}{1-\lambda} < \frac{3-\lambda}{1+\lambda} \varepsilon < \frac{1-\lambda}{2\lambda} \varepsilon$$

#### 4.1 CASE (i) $\lambda > 3 - 2\sqrt{2}$ :

The figure below shows how a firm ranks the different potential best-responses for all possible prices played by their opponent:

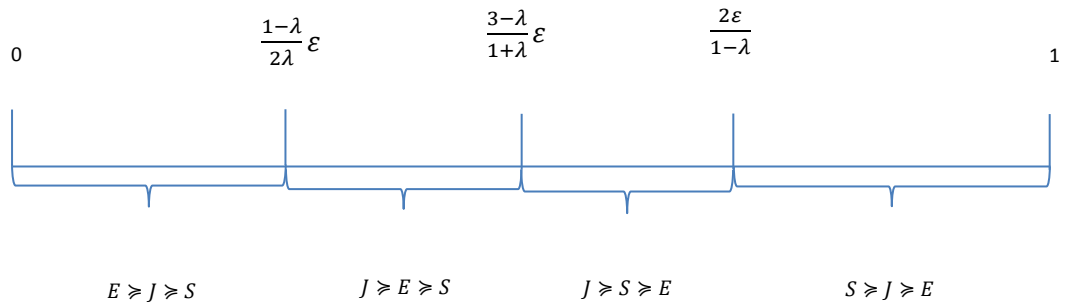

Figure 7: How a firm ranks potential best responses depending on the price offered by their competitor.

If we begin by thinking in terms of the pure strategy dynamics: suppose firm  $j$  offers a (discrete) price in the interval  $(\frac{1-\lambda}{2\lambda} \varepsilon, \frac{2\varepsilon}{1-\lambda})$ , firm  $i$ 's best response is to just undercut firm  $j$ 's price by

<sup>14</sup> We will be able to do this if we require  $\lambda$  and  $\delta$  to be rational numbers. I am grateful to Ioanna Manolopoulou for confirming the intuition for this.

offering the next price below i.e. offer the price which is  $\delta$  less than firm j's price. Firm j in turn undercuts firm i. They continue in this fashion, like in a discrete version of Bertrand competition, just undercutting one another until one of the firms offers a price of  $\frac{1-\lambda}{2\lambda}\varepsilon$ , at this point the other firm prefers to play E rather than J as a response i.e. offer a price  $\frac{1+\lambda}{2\lambda}\varepsilon$ , which is  $\varepsilon$  more than their competitor. What happens next depends on whether  $\frac{1+\lambda}{2\lambda}\varepsilon$  is greater than or less than  $\frac{2\varepsilon}{1-\lambda}$ : if less than, the two firms enter the 'Bertrand phase' again and continue to undercut one another until reaching the price  $\frac{1-\lambda}{2\lambda}\varepsilon$ . This is because the price remains in the interval where 'just undercutting' is the best response. This behaviour repeats itself as an *edgeworth cycle*. However if  $\frac{1+\lambda}{2\lambda}\varepsilon$  is greater than  $\frac{2\varepsilon}{1-\lambda}$  the price enters the 'steal' region and a firm's best response to a price in this region is to offer a price sufficiently low so that it attracts all the consumers. Thus we proceed by splitting case (i) into two subcases.

*Case (i)(a)  $\lambda > -2 + \sqrt{5}$*

The intuition here is that when the proportion of informed consumers,  $\lambda$ , is large 'just undercut' becomes a more attractive best response. This is because being a small amount cheaper than one's competitor is sufficient to take all of the informed consumers away from them. We should therefore not be surprised that small  $\lambda$  is associated with a larger region of prices where 'just undercut' is the best response. In this case we have that  $\frac{2\varepsilon}{1-\lambda} - \frac{1-\lambda}{2\lambda}\varepsilon > \varepsilon$ . This ensures that in the pure strategy dynamics when the price jumps by  $\varepsilon$  it does not enter the 'steal' region but rather remains in the 'just undercut' region. We can now state the following result:

**Result 2:** *When  $\lambda \in (-2 + \sqrt{5}, 1)$  there is no equilibrium in pure strategies but as  $\delta \rightarrow 0$  the pure strategies which are rationalisable tend to those discrete prices in the interval  $\left[\frac{1-\lambda}{2\lambda}\varepsilon, \frac{1+\lambda}{2\lambda}\varepsilon\right]$ .*

**Proof:** This follows from the discussion of the pure strategy dynamics given above. QED.

The reason the condition on  $\lambda$  here is that it should be greater than  $-2 + \sqrt{5}$  is because this ensures that  $\frac{2\varepsilon}{1-\lambda} - \frac{1-\lambda}{2\lambda}\varepsilon > \varepsilon$ . That is, it ensures that in the pure strategy dynamics when the

price ‘jumps’ by  $\epsilon$  it does not enter the ‘steal’ region but rather remains in the ‘just undercut’ region. Notice that as:  $\lambda \rightarrow 1$ , i.e. as almost all consumers become informed, the set of rationalisable prices tends to  $p \in [0, \epsilon]$  and as  $\epsilon \rightarrow 0$ , i.e. as search costs fall to zero  $p = 0$  is the only rationalisable price. Later we will see that in fact, in mixed strategy equilibrium, as  $\lambda \rightarrow 1$  all of the mass will become concentrated at  $p = 0$ . This is a good consistency check for us, since either  $\lambda \rightarrow 1$  or  $\epsilon \rightarrow 0$  represents a game of Bertrand competition.

Case (i)(b)  $\lambda \in [3 - 2\sqrt{2}, -2 + \sqrt{5}]$

Here, although the proportion of informed consumers is relatively large, it is not sufficiently large for the price path of the pure strategy dynamics to enter the ‘just undercut’ region when the price first ‘jumps’ on entering the ‘exploit’ region. This has certain implications for the pure strategy dynamics and therefore the set of rationalisable prices.

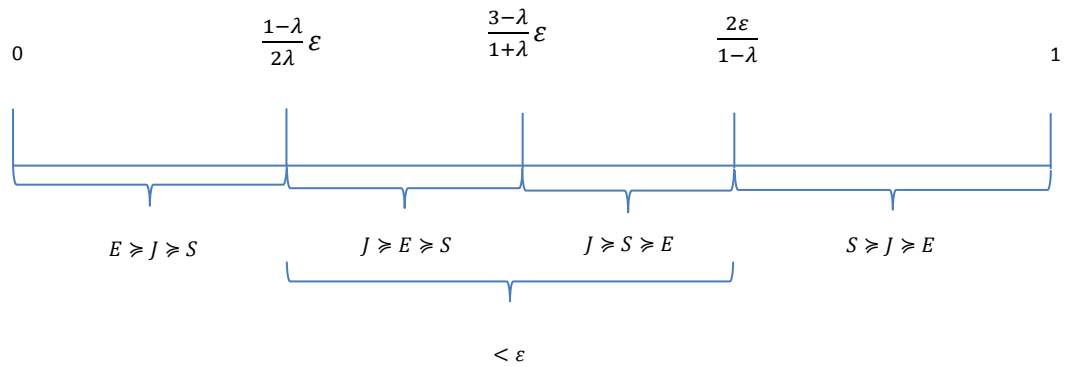

Figure 8: How a firm ranks potential best responses depending on the price offered by their competitor.

Notice that for these values of  $\lambda$  the interval  $\left[\frac{1-\lambda}{2\lambda}\epsilon, \frac{2\epsilon}{1-\lambda}\right]$  is less than  $\epsilon$  in length. This is important since it affects the pure strategy dynamics: consider the dynamics which follow firm  $i$  pricing in the interval  $\left(\frac{1-\lambda}{2\lambda}\epsilon, \frac{2\epsilon}{1-\lambda}\right)$ , firm  $j$  will wish to best respond by just undercutting firm  $i$ 's price, firm  $i$  will in turn just under cut firm  $j$  and so on. This pushes prices down in a Bertrand fashion until one of the firms, say firm  $i$ , offers a price of  $\frac{1-\lambda}{2\lambda}\epsilon$  at which point firm  $j$  prefers to ‘exploit’ (offer a price of  $\frac{1+\lambda}{2\lambda}\epsilon$ ) rather than undercut. Since the just-undercutting interval is now less than  $\epsilon$  in

length, the price  $\frac{1+\lambda}{2\lambda}\varepsilon$  now belongs in the ‘steal’ region. Firm i’s best response is to now offer a price  $\delta$  below  $\frac{1-\lambda}{2\lambda}\varepsilon$ , firm j responds by lowering its price by  $\delta$  also, and they continue in this quasi-Bertrand fashion until firm j’s price hits  $\frac{2\varepsilon}{1-\lambda}$ . Now firm i prefers to just undercut rather than steal and they enter the standard Bertrand phase again, and so on.<sup>15</sup> This cycle of prices provides the infinite chain of justification which gives us the following result:

**Result 3:** *When  $\lambda \in [3 - 2\sqrt{2}, -2 + \sqrt{5}]$  there is no equilibrium in pure strategies but as  $\delta \rightarrow 0$  the pure strategies which are rationalisable tend to those discrete prices in the interval  $[\frac{1+\lambda}{1-\lambda}\varepsilon, \frac{1+\lambda}{2\lambda}\varepsilon]$ .*

We can either see this result using the pure strategy dynamics above and using this as the infinite chain of justification or we can iteratively delete prices which are never a best response which leaves us with the same interval.

#### 4.2 CASE (ii) $\lambda < 3 - 2\sqrt{2}$ :

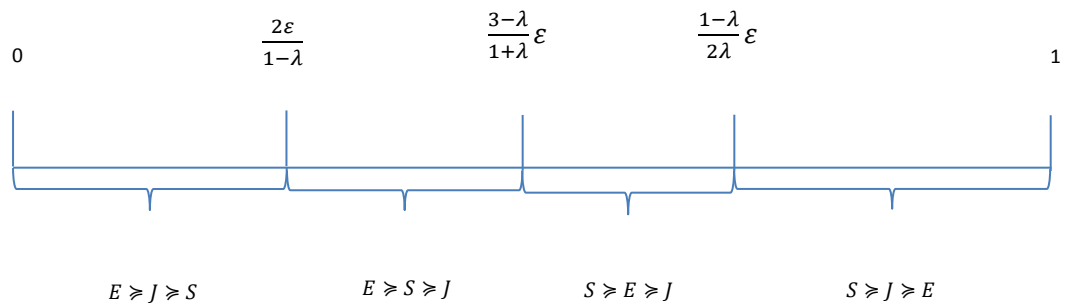

**Figure 9:** How a firm ranks potential best responses depending on the price offered by their competitor.

Again, we begin by considering the pure-strategy dynamics. Suppose firm i chooses a price in the interval  $(\frac{3-\lambda}{1+\lambda}\varepsilon, \frac{4\varepsilon}{1+\lambda}]$ . Firm j will wish to best respond by offering a price which undercuts it by  $\varepsilon + \delta$ . Firm i will respond by just lowering its price by  $\delta$  and the two firms continue undercutting one another in a quasi-Bertrand fashion until firm i’s price reaches  $\frac{3-\lambda}{1+\lambda}\varepsilon$ , at this

<sup>15</sup> The reason I call this ‘quasi-Bertrand’ is that they continue to undercut one another whilst always maintaining an  $\varepsilon$  gap between their prices.

point firm  $j$  prefers to ‘exploit’ rather than ‘steal’ and offers the price  $\frac{4\varepsilon}{1+\lambda}$ . They then enter the quasi-Bertrand stage and this cycle continues forever. This gives us our result:

**Result 4:** *When  $\lambda < 3 - 2\sqrt{2}$  there is no equilibrium in pure strategies but as  $\delta \rightarrow 0$  the pure strategies which are rationalisable tend to those discrete prices in the interval  $\left[\frac{2(1-\lambda)}{1+\lambda}\varepsilon, \frac{4\varepsilon}{1+\lambda}\right]$ .*

Again, we can see this result either by creating an infinite chain of justification using the pure strategy dynamics above or by iteratively deleting prices which are never a best response. Notice that as:  $\lambda \rightarrow 0$ , i.e. as the number of informed consumers goes to zero, the rationalisable interval of prices becomes  $p \in [2\varepsilon, 4\varepsilon]$  this is what we expect since  $\lambda \rightarrow 0$  is equivalent to our baseline model in Chapter 1. We know that in that case the rationalisable prices when firms are restricted to pure strategies and discrete prices are approximately those in the interval  $[2\varepsilon, 4\varepsilon]$ . Furthermore we can see that as  $\varepsilon \rightarrow 0$ , the only rationalisable price becomes  $p = 0$ . This makes sense since search costs going to zero means that this game will be equivalent to a game of Bertrand competition.

## 5 MIXED STRATEGIES AND CONTINUOUS PRICES

Since there is no equilibrium in pure strategies, we must look to mixed strategies if we are to find an equilibrium. In this section we consider the game where firms can play mixed strategies and offer any price in the interval  $[0, 1]$ . For sufficiently large  $\lambda$ , we find a symmetric equilibrium where firms randomise over an interval of length  $\varepsilon$ . This is the substantive result of this chapter. It turns out that the support of the mixed strategy equilibrium coincides with the interval of rationalisable prices found in Result 2 (albeit for more values of  $\lambda$ ). Furthermore, it is the only symmetric equilibrium where firms randomise on an interval of length  $\varepsilon$ . In this equilibrium, firms first choose their mixed strategies. Nature then takes a draw from each. Since the support is of length  $\varepsilon$ , the distance between the two drawn prices cannot be more than  $\varepsilon$ . This means that uninformed consumers will always purchase at the first store that they visit; informed consumers purchase from the cheapest store.

**Result 5:** For  $\lambda > \frac{1}{5}[1 - \lambda^2 - 3\lambda^3]$  there is a symmetric mixed strategy Nash equilibrium of the game where both firms offer prices on the support  $\left[\frac{1-\lambda}{2\lambda}\varepsilon, \frac{1+\lambda}{2\lambda}\varepsilon\right]$ . The equilibrium distribution of prices is given by the cumulative distribution function:

$$F(p_i) = \frac{1 + \lambda}{2\lambda} \left[ 1 - \frac{(1 - \lambda)\varepsilon}{2\lambda p_i} \right].$$

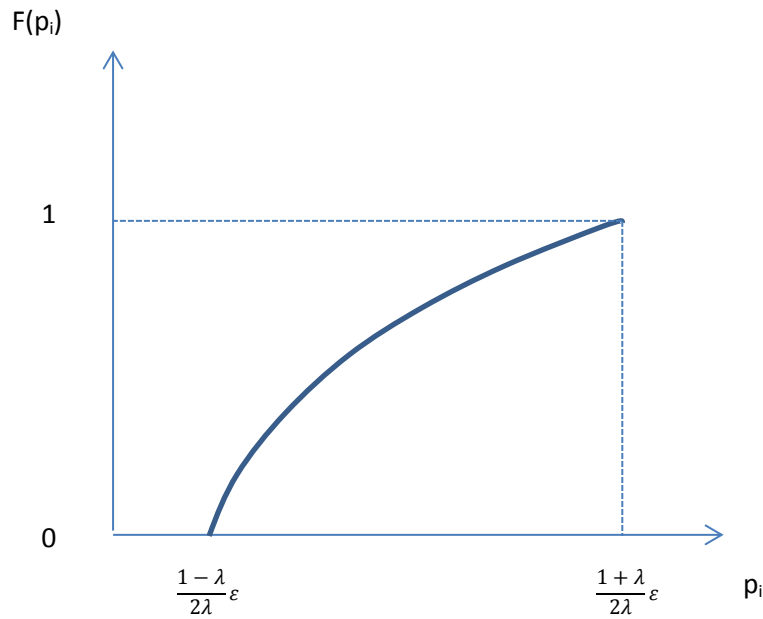

Figure 10: The CDF of the symmetric mixed strategy Nash equilibrium.

Firms make profits in equilibrium of  $\pi = \frac{(1-\lambda^2)\varepsilon}{4\lambda}$ .

**Proof:** We break the proof into two parts. First, we show that if one of the firms plays according to  $F$ , then the other firm is indifferent to playing any price in the support of  $F$ . Next, we show that a firm cannot do better by offering a price not in the support of  $F$  when their opponent plays according to  $F$ .

- (i) Show that if one of the firms plays according to  $F$ , then the other firm is indifferent to playing any price in the support of  $F$ .



Suppose firm  $j$  randomises on the interval  $[a, a + \varepsilon]$  using a distribution with CDF  $F(\cdot)$ . Firm  $i$ 's expected profit from playing  $p_i \in [a, a + \varepsilon]$  is then:

$$E[\pi_i(p_i, F)] = p_i[(1 - \lambda)/2 + \lambda(1 - F(p_i))]$$

That is, whatever price is offered in this interval, since it is only  $\varepsilon$  in length, a firm will sell to half of the uninformed consumers. Whether it sells to the informed consumers depends upon whether firm  $j$ 's price is greater than or less than firm  $i$ 's price. Firm  $j$ 's price will be greater than firm  $i$ 's price with probability  $1 - F(p_i)$ . In a symmetric Nash Equilibrium, firm  $i$  should be indifferent between playing any action in the support of  $F$ , that is:  $E[\pi_i(p_i, F)] = \pi \forall p_i \in [a, a + \varepsilon]$ . Rearranging:

$$F(p_i) = \frac{1}{\lambda} \left[ \frac{1 + \lambda}{2} - \frac{\pi}{p_i} \right].$$

Imposing no masses at the ends of the support:

$$F(a) = 0 \Rightarrow \pi = \left( \frac{1 + \lambda}{2} \right) a, \quad F(a + \varepsilon) = 1 \Rightarrow \pi = \left( \frac{1 - \lambda}{2} \right) (a + \varepsilon).$$

Equating the two expressions for profits above allows us to solve for  $a$ , which we then plug back into the expression for profits:

$$a = \left( \frac{1 - \lambda}{2\lambda} \right) \varepsilon \Rightarrow \pi = \frac{(1 - \lambda^2)\varepsilon}{4\lambda},$$

$$\therefore F(p_i) = \frac{1 + \lambda}{2\lambda} \left[ 1 - \frac{(1 - \lambda)\varepsilon}{2\lambda p_i} \right].$$

(ii) *Now we check no firm can do better by pricing outside of the interval.*

First, we check prices below the interval: at a price of  $\left( \frac{1 - 3\lambda}{2\lambda} \right) \varepsilon$  a firm can be sure of attracting all consumers, so all prices below this price are dominated. Thus, we need to check that offering a price  $p_i^l \in \left[ \left( \frac{1 - 3\lambda}{2\lambda} \right) \varepsilon, \left( \frac{1 - \lambda}{2\lambda} \right) \varepsilon \right]$  does not yield higher profits than the equilibrium profits.

$$E[\pi_i(p_i^l, F)] = p_i^l \left[ 1 - \left( \frac{1 - \lambda}{2} \right) F(p_i^l + \varepsilon) \right]$$

$$= p_i^L \left[ 1 - \frac{1 - \lambda^2}{4\lambda} \left( 1 - \frac{(1 - \lambda)\varepsilon}{2\lambda(p_i^L + \varepsilon)} \right) \right]$$

This expression says that if firm  $i$  offers a price  $p_i^L \in \left[ \left( \frac{1-3\lambda}{2\lambda} \right) \varepsilon, \left( \frac{1-\lambda}{2\lambda} \right) \varepsilon \right]$  while the other firm plays according to the posited equilibrium  $F$ , then it will get all of the consumers less half of the uninformed consumers when firm  $j$ 's price is within  $\varepsilon$  of its price. If we can find conditions under which  $\pi_i'(p_i^L) > 0$ , then this will be sufficient to show that it is preferable to play according to  $F(\cdot)$  rather than any price  $p_i^L \in \left[ \left( \frac{1-3\lambda}{2\lambda} \right) \varepsilon, \left( \frac{1-\lambda}{2\lambda} \right) \varepsilon \right]$ . Taking the derivative, we have,

$$\pi_i'(p_i^L) = 1 - \frac{1 - \lambda^2}{4\lambda} \left( 1 - \frac{(1 - \lambda)\varepsilon^2}{2\lambda(p_i^L + \varepsilon)^2} \right).$$

We need to find out when this is positive, or equivalently when:

$$\frac{1 - \lambda^2}{4\lambda} \left( 1 - \frac{(1 - \lambda)\varepsilon^2}{2\lambda(p_i^L + \varepsilon)^2} \right) < 1.$$

The expression on the LHS is clearly increasing in  $p_i^L$ . So it will be maximised at  $p_i^L = \left( \frac{1-\lambda}{2\lambda} \right) \varepsilon$ .

From this, we know that the largest the LHS can be is  $\frac{(1+3\lambda^2)(1-\lambda)}{4\lambda(1+\lambda)}$  (which we want to be less than one):

$$\frac{(1 + 3\lambda^2)(1 - \lambda)}{4\lambda(1 + \lambda)} < 1$$

$$\Leftrightarrow (1 + 3\lambda^2)(1 - \lambda) < 4\lambda(1 + \lambda)$$

$$\Leftrightarrow \lambda > \frac{1}{5}[1 - \lambda^2 - 3\lambda^3].$$

Using an iterative solution for  $\lambda = \frac{1}{5}[1 - \lambda^2 - 3\lambda^3]$  we can get an approximation  $\lambda > 0.19$ . We

now check that firms do not prefer to price above the equilibrium interval  $\left[ \frac{1-\lambda}{2\lambda} \varepsilon, \frac{1+\lambda}{2\lambda} \varepsilon \right]$ . Notice

that at prices above  $\left( \frac{1+3\lambda}{2\lambda} \right) \varepsilon$  a firm will make zero profits (since this price is always more than  $\varepsilon$  higher than a competitor's price), so we only need to check profits from pricing in the interval

$p_i^H \in \left[ \left( \frac{1+\lambda}{2\lambda} \right) \varepsilon, \left( \frac{1+3\lambda}{2\lambda} \right) \varepsilon \right]$ . The expected profit to a firm from offering such a price when his opponent is offering prices according to  $F$  is given by:

$$\begin{aligned} E[\pi_i(p_i^H, F)] &= p_i^H \left( \frac{1-\lambda}{2} \right) [1 - F(p_i^H - \varepsilon)] \\ &= p_i^H \left( \frac{1-\lambda}{2} \right) \left[ 1 - \frac{1+\lambda}{2\lambda} \left( 1 - \frac{(1-\lambda)\varepsilon}{2\lambda(p_i^H - \varepsilon)} \right) \right] \end{aligned}$$

That is, when offering a price  $p_i^H$  a firm will never be able to sell to informed consumers since the competitor's price will always be less. It can however sell to half of the uninformed consumers so long as its price is not more than  $\varepsilon$  greater than its competitor's price. To show that firms will never wish to price in this interval it will be sufficient to show that the derivative of the profit function in this range of prices is negative. The derivative of the profit function is:

$$\pi_i'(p_i^H) = \left( \frac{1-\lambda}{2} \right) \left[ 1 - \frac{1+\lambda}{2\lambda} \left( 1 - \frac{(1-\lambda)\varepsilon}{2\lambda(p_i^H - \varepsilon)} \right) \right] - \frac{(1-\lambda)^2(1+\lambda)\varepsilon p_i^H}{8\lambda^2(p_i^H - \varepsilon)^2}$$

We can show that this expression is negative by noticing that the inequality below must always hold:

$$\frac{(1+\lambda)\varepsilon}{2\lambda(p_i^H - \varepsilon)} \left[ 1 - \frac{p_i^H}{p_i^H - \varepsilon} \right] < 1$$

This is because the first fraction will always be positive and the expression in the square brackets will always be negative. It implies that:

$$\frac{(1+\lambda)\varepsilon}{8\lambda(p_i^H - \varepsilon)} - \frac{1}{4} - \frac{(1+\lambda)\varepsilon p_i^H}{8\lambda(p_i^H - \varepsilon)^2} < 0.$$

Multiplying by  $\frac{(1-\lambda)^2}{2}$  gives us

$$\frac{1-\lambda}{2} \left[ \frac{(1-\lambda^2)\varepsilon}{4\lambda^2(p_i^H - \varepsilon)} - \frac{1-\lambda}{2\lambda} \right] - \frac{(1-\lambda)^2(1+\lambda)\varepsilon p_i^H}{8\lambda^2(p_i^H - \varepsilon)^2} < 0.$$

The left hand side of the expression above is just  $\pi'_i(p_i^H)$

$$\therefore \pi'_i(p_i^H) < 0.$$

To summarise, first we showed that if one of the firms plays according to F, then the other firm is indifferent to playing any price in the support of F. Next, we checked that no firm can do better by playing a price outside of the support of F if its opponent is playing according to F. This is sufficient to show that F is a symmetric mixed-strategy Nash equilibrium. QED

This is an equilibrium for sufficiently large  $\lambda$ . It is instructive to consider the intuition for this. Suppose that the posited equilibrium strategy offers prices in the  $\epsilon$ -length interval  $[a, a+\epsilon]$ . We know that (for all  $\lambda$ ) if firm j is playing according to F, firm i will be indifferent to all the prices in the interval. What we cannot be sure about is that firm i cannot do better by offering a price lower than a. Suppose that firm i offers the price  $a' < a$ , it is already selling to all of the informed consumers at price a and they will continue to purchase from firm i at price  $a'$ . However firm i will increase its expected sales to uninformed consumers, in particular if its competitor offers a price in the interval  $(a' + \epsilon, a + \epsilon]$ , it now sells to all of the uninformed consumers instead of only half of them. When  $\lambda$  is small, there are relatively many uninformed consumers and so offering a price less than a looks attractive since firm i is compensated for offering a lower price by gaining a relatively large quantity of expected sales.

In equilibrium, firms randomise over an  $\epsilon$ -length interval. This means that whatever the realisation of the prices, the two prices will always be within  $\epsilon$  distance of one another. Thus, for all realisations of prices, the uninformed consumers purchase from the store that they initially visit. Each firm therefore sells to half of the uninformed consumers. The sole reason then for a firm to offer a lower price within this interval is that there is an increased probability of selling to the informed consumers. Viewing this equilibrium from an efficiency perspective, it is clear that it is efficient. This is because trade always occurs (so long as search costs are not too large). Furthermore, since realised prices are always within  $\epsilon$  of one another, there is no deadweight loss due to search, since no one will search in equilibrium.

## 5.1 EXPECTED PRICES IN EQUILIBRIUM

We find the expected price offered by a firm in equilibrium.

**Result 6:** *In equilibrium, the expected price offered by a firm will be  $\frac{(1-\lambda^2)\varepsilon}{4\lambda^2} \ln\left(\frac{1+\lambda}{1-\lambda}\right)$ .*

**Proof:**

$$E[p] = \int_{\frac{1-\lambda}{2\lambda}\varepsilon}^{\frac{1+\lambda}{2\lambda}\varepsilon} pf(p) dp$$

Since we know that the CDF is given by

$$F(p_i) = \frac{1+\lambda}{2\lambda} \left[ 1 - \frac{(1-\lambda)\varepsilon}{2\lambda p_i} \right]$$

We have that:

$$f(p_i) = \frac{(1-\lambda^2)\varepsilon}{4\lambda^2 p_i^2}$$

$$\therefore E[p] = \int_{\frac{1-\lambda}{2\lambda}\varepsilon}^{\frac{1+\lambda}{2\lambda}\varepsilon} \frac{(1-\lambda^2)\varepsilon}{4\lambda^2 p} dp$$

$$\Rightarrow E[p] = \frac{(1-\lambda^2)\varepsilon}{4\lambda^2} \int_{\frac{1-\lambda}{2\lambda}\varepsilon}^{\frac{1+\lambda}{2\lambda}\varepsilon} \frac{1}{p} dp = \frac{(1-\lambda^2)\varepsilon}{4\lambda^2} \ln\left(\frac{1+\lambda}{1-\lambda}\right)$$

■

It is important to understand that for an uninformed consumer this is the expected price that he will pay. This is because an uninformed consumer will randomly visit one of the two stores and make a purchase. While an informed consumer will typically do better, since they will be able to purchase at the lower of the two prices i.e. they will pay the lower of the two draws from  $F$ .

**Result 7:** *In equilibrium, the expected price paid by an informed consumer will be*

$$\frac{(1 - \lambda^2)\varepsilon}{4\lambda^3} \left[ 2\lambda - (1 - \lambda) \ln \left( \frac{1 + \lambda}{1 - \lambda} \right) \right].$$

**Proof:**

$$E[p] = \int_{\frac{1-\lambda}{2\lambda}\varepsilon}^{\frac{1+\lambda}{2\lambda}\varepsilon} p \hat{f}(p) dp$$

Where  $\hat{f}(p)$  is the density associated with the minimum of two draws from the distribution  $F$ .

In particular:

$$\hat{f}(p) = 2f(p)[1 - F(p)]$$

That is, the density of  $\hat{f}$  at a particular value for  $p$  can be calculated by taking the standard density  $f$  at that value of  $p$ , multiplying it by the probability that the price of the ‘other firm’ will be greater than  $p$ , i.e.  $[1 - F(p)]$ , which we multiply by two to recognise that either of the two firms could be offering the lower of the two prices,  $p$ . This gives us that (ignoring the limits for the moment):

$$\begin{aligned} E[p] &= \int \frac{(1 - \lambda^2)\varepsilon}{2\lambda^2 p} \left[ 1 - \frac{1 + \lambda}{2\lambda} \left[ 1 - \frac{(1 - \lambda)\varepsilon}{2\lambda p} \right] \right] dp \\ &= \frac{(1 - \lambda^2)\varepsilon}{2\lambda^2} \int \frac{1}{p} \left[ 1 - \frac{1 + \lambda}{2\lambda} + \frac{(1 - \lambda^2)\varepsilon}{4\lambda^2 p} \right] dp \\ &= \frac{(1 - \lambda^2)\varepsilon}{2\lambda^2} \cdot \frac{1}{2\lambda} \int \frac{1}{p} \left[ (\lambda - 1) + \frac{(1 - \lambda^2)\varepsilon}{2\lambda p} \right] dp \\ &= \frac{(1 - \lambda^2)\varepsilon}{4\lambda^3} \left[ (\lambda - 1) \int \frac{1}{p} dp + \frac{(1 - \lambda^2)\varepsilon}{2\lambda} \int p^{-2} dp \right]. \end{aligned}$$

Integrating and applying the correct limits, we have

$$E[p] = \frac{(1 - \lambda^2)\varepsilon}{4\lambda^3} \left[ 2\lambda - (1 - \lambda) \ln \left( \frac{1 + \lambda}{1 - \lambda} \right) \right].$$

QED

Our equilibrium is different to the one found in Varian (1980). In his paper, in equilibrium, firms offer all prices in the interval  $[c, r]$  with strictly positive density. Where  $c$  is the average cost of production and  $r$  is the reservation price. Varian's equilibrium is independent of the cost of search. This is because it is assumed that uninformed consumers never search, they simply buy at the first shop that they arrive at, so long as it charges below their reservation price. In our paper, uninformed consumers may still search if they visit an expensive store and they know that there are cheaper prices out there which warrant incurring search costs. That is, in our paper uninformed consumers are indeed uninformed but they are not fools. Equilibrium in this chapter has all the desirable properties of Chapter 1 i.e. price dispersion in equilibrium; expected prices increasing smoothly as the search cost increases; and greater price dispersion when search costs are large. In addition, the equilibrium in this chapter is efficient while in Chapter 1 there is a deadweight loss due to additional search.

## **6 RELATIONSHIP TO BERTRAND COMPETITION AND THE BASELINE CASE**

Recapping on what we have found, there is an equilibrium where, for sufficiently large  $\lambda$ , firms randomise on an interval of length  $\varepsilon$ . As  $\lambda \rightarrow 1$  all consumers become informed, meaning that they purchase at the firm with the lowest price. We should expect this equilibrium to tend to Bertrand competition in this case. However, as  $\lambda \rightarrow 0$  we do not expect that this equilibrium should tend to our baseline equilibrium in Chapter 1. This is because it is no longer an equilibrium for small  $\lambda$ . Checking that as  $\lambda \rightarrow 1$  the equilibrium tends to Bertrand competition:

$$F(p_i) = \frac{1 + \lambda}{2\lambda} \left[ 1 - \frac{(1 - \lambda)\varepsilon}{2\lambda p_i} \right], \quad p_i \in \left[ \frac{1 - \lambda}{2\lambda} \varepsilon, \frac{1 + \lambda}{2\lambda} \varepsilon \right]$$

We see that as  $\lambda \rightarrow 1$ , the interval becomes  $[0, \varepsilon]$  and that  $F(p_i) \rightarrow 1$  for all  $p_i \in [0, \varepsilon]$ . This is consistent with Bertrand competition since it means that all of the weight is concentrated on  $p=0$ . This is the limiting case, but in general, we notice that as  $\lambda$  increases, the interval of prices shifts towards the left whilst maintaining its  $\varepsilon$ -length. Furthermore, weight becomes more

heavily placed on the lower prices in the interval, and in the limit, all the weight is placed on the lowest price in the interval. We can see this more clearly if we plot the expected price offered by a firm as a function of the proportion of informed consumers.

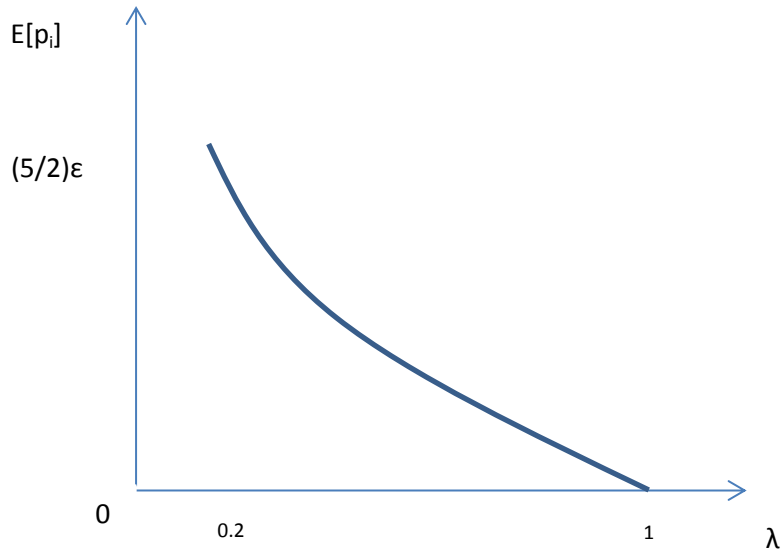

Figure 11: How expected prices offered by firms vary with the proportion of informed consumers.

Similarly, we can see what happens as  $\epsilon \rightarrow 0$ . Since no search costs effectively reduces our model to Bertrand competition, we should expect that all weight is again concentrated on  $p = 0$ . We can see that this will be satisfied by inspecting the support of the equilibrium distribution as  $\epsilon \rightarrow 0$ :

$$\left[ \frac{1-\lambda}{2\lambda} \epsilon, \frac{1+\lambda}{2\lambda} \epsilon \right] \rightarrow [0]$$

In what circumstances can we say for sure that consumers will pay a lower price in this model – where some consumers are informed of a free comparison site – compared to the baseline presented in chapter 1? Well, in the baseline model, the lowest possible price offered to a consumer in equilibrium is  $\sqrt{2}\epsilon$ . While in this model the highest possible price offered in equilibrium is  $\frac{1+\lambda}{2\lambda}\epsilon$ . So when  $\frac{1+\lambda}{2\lambda}\epsilon < \sqrt{2}\epsilon$  we know that the consumer will be better off for sure (whether he is informed or uninformed). This occurs when  $\lambda > \frac{1}{-1+2\sqrt{2}} \cong 0.55$ . That is, if the proportion of informed consumers is above around 55%. A related question is: is it possible



that in equilibrium, in this model, a consumer would pay more than the highest realised price in the baseline model? For that to be the case it must be that  $\frac{1+\lambda}{2\lambda}\varepsilon > (2 + \sqrt{2})\varepsilon$  i.e that  $\lambda < \frac{1}{3+2\sqrt{2}} \cong 0.17$ . But the model presented in this chapter is not an equilibrium for such a small value of  $\lambda$ .

## 7 CONCLUDING REMARKS

We can draw the following conclusions. In the baseline case there is a deadweight loss due to search. If we introduce a free comparison site then there exists an equilibrium (for sufficiently large  $\lambda$ ) where firms price in an interval of  $\varepsilon$ -length. This means that no one will search in equilibrium whether they are informed or not. The informed will not search since they already have access to the lowest price. While the uninformed will not search after arriving at the first store since they will never be able to find a price sufficiently lower than the currently available price to warrant an additional search. Since trade will always occur and there are no losses due to search costs, the equilibrium presented in this chapter is efficient. Furthermore, it is impossible that in this equilibrium a consumer will pay more than the highest possible price in the baseline model, and also we have shown that if  $\lambda$  is sufficiently large they will definitely pay less. Finally, we notice that the informed consumers have a ‘positive externality’ on the uninformed consumers in this model. This is because we have shown that the expected price offered by a firm is falling in  $\lambda$ . The intuition for this being that since firms are unable to offer different prices to informed and uninformed consumers, once they arrive at the store, the uninformed consumers benefit from the additional competitive pressures which result from more informed (and thus more price sensitive) consumers.

In terms of potential policy implications, a government may want to introduce such a free service so long as they could ensure that enough consumers became informed for the equilibrium presented in this chapter to emerge. There would be a clear efficiency case due to the absence of deadweight losses due to costly search. There may also be an equity case, since for sufficiently large  $\lambda$  consumers pay lower prices for sure. However we must caveat this with the fact that there may exist other equilibria in this model. That is, the equilibrium presented

here may or may not be unique. We are not sure either way and clearly other equilibria, if they exist, may have different properties.

# **CHAPTER 3: COMMISSION FEES AND EXTENSIONS**

## **1 INTRODUCTION**

Here we extend the analysis presented in Chapter 2 to allow for the comparison site to charge a commission fee whenever a sale is made through them. This is a natural extension since comparison sites are rarely free to users and frequently make use of this kind of payment structure. A summary of the relevant literature can be found in Chapter 2, we do not repeat it here.

### **1.1 THE STRUCTURE OF THE CHAPTER**

In Section 2 we outline the model, consider how consumers will optimally search and also under what circumstances the baseline equilibrium presented in Chapter 1 remains an equilibrium in this new setting. In Section 3 we consider optimal firm behaviour given that consumers are going to behave optimally. Initially, we let the action space be continuous and look at how different values of the commission fee change the strategic incentives faces by firms to list or unlist. We find one pure strategy Nash equilibrium when the commission fee is not more than the search cost; we also find that there does not exist a pure strategy Nash equilibrium when the commission fee is chosen to be greater than the search cost. Next, we let the action space be discrete in order to analyse the pure strategy dynamics. We are unable to find any extra mixed strategy equilibria in addition to the baseline equilibria. In Section 4 we consider whether firms and the price comparison website (PCW) may find it in their interests to deceive consumers by not always revealing all posted prices. We find that if consumers believe that the PCW is being truthful and revealing all available information when in fact it is not, it becomes possible to extract the consumers' entire surplus. In Section 5 we analyse the baseline model again, focusing on the strategic incentives consumers and firms face when there are three firms.

## 2 THE MODEL

We assume that all consumers are aware of the price comparison website but we extend the model so that each time a purchase is made through the price comparison website the firm must pay a strictly positive commission  $t > 0$ . As in the previous two chapters, there is a unit mass of consumers searching for the lowest price for one unit of a good which they value at  $v = 1$ , they do not know the prices at any given store until they visit but they do know the *realised* distribution of prices. Visiting a store incurs a search cost  $\epsilon$  for the consumer. Firms can produce the good costlessly. This is all common knowledge. In this chapter, firms have to pay a commission  $t > 0$  for every sale that is made through the PCW and the PCW imposes the restriction that the firm cannot undercut the price it lists on the PCW if the consumer visits the firm independently.

### *Timing of the game*

1. The Price Comparison Site chooses the level at which to set the commission fee,  $t$ .
2.  $N$  firms simultaneously each choose whether to list their price on the Price Comparison Site or not.
3. Without knowledge of the listing decision of their competitors,  $N$  firms simultaneously each choose a distribution  $F_i$  ( $i = 1, \dots, N$ ) from which their price will be drawn.
4. Nature draws a single price  $p_i$  from each distribution  $F_i$ .
5. Consumers are presented with (i) the collection of listed prices, for these prices they know which price is associated with which store, and (ii) the collection of unlisted prices, for these prices they do not know which price is associated with which store.
6. Consumers engage in costly search (or not) and decide whether or not to make a purchase.
7. If a purchase is made through the Price Comparison Site, a commission fee,  $t$ , is payable by the firm to the Price Comparison Site.

We restrict attention to the two-firm case and assume that all consumers know about the PCW and that it is costless for them to visit. Throughout the chapter we will assume that the cost of search and the commission fee are not very large compared to the consumer's valuation of the good. In particular we assume the following:

**Assumption 1:**  $\varepsilon < \frac{1}{4}$ ,  $t < \frac{1}{2}$ .

## 2.1 OPTIMAL CONSUMER SEARCH

All of the consumers search the PCW first since this is a weakly dominant strategy (strictly dominant if there is some probability that the lowest available price will be listed here). Either no prices are listed, in which case consumers search as in Chapter 1, or at least one price is listed and this reveals the prices at both stores. Recall that in the two-firm case the consumer is aware of both prices being charged before engaging in any search. Once they are able to link one of the prices to one of the firms, this is fully revealing about the price being charged by the other firm. If this is the case, the consumer can either purchase with no additional search cost at the price listed on the PCW or else pay a search cost,  $\varepsilon$ , to visit the other store. A natural question to begin with is: under what conditions will the baseline equilibrium found in Chapter 1 remain an equilibrium?

## 2.2 WHEN DOES THE BASELINE EQUILIBRIUM COLLAPSE?

Recall that in the baseline case there did not exist a pure-strategy Nash equilibrium but that there did exist a unique symmetric mixed-strategy Nash equilibrium. In order for the baseline equilibrium to remain an equilibrium once commission fees are introduced it must be that no firm prefers to list instead of play the baseline equilibrium when their opponent is playing the baseline equilibrium. We are able to show the following result:

**Result 1:** *If  $t < \frac{1}{2}(2 + \sqrt{2})\varepsilon$ , then the baseline equilibrium where both firms are unlisted and price according to the distribution  $F$  will no longer be an equilibrium when there exists a price comparison website which all*

consumers know about and can costlessly use but which charges firms a commission of  $t > 0$  each time a sale is made.

**Proof:** Suppose that firm  $j$  plays according to the baseline mixed-strategy Nash equilibrium:

$$F(p_j) = \begin{cases} 1 - \frac{(1 + \sqrt{2})\varepsilon}{p_j + \varepsilon}, & p_j \in [\sqrt{2}\varepsilon, (1 + \sqrt{2})\varepsilon] \\ 2 \left[ 1 - \frac{(1 + \sqrt{2})\varepsilon}{2(p_j - \varepsilon)} \right], & p_j \in [(1 + \sqrt{2})\varepsilon, (2 + \sqrt{2})\varepsilon] \end{cases}$$

We know that for firm  $i$ , out of all of the strategies which involve not listing, also playing according to  $F(\cdot)$  does at least as well as any other strategy when firm  $j$  plays according to  $F$ . The question is, is it a best response for firm  $i$  to also not list and play according to  $F(\cdot)$  or does it prefer to list and play some other distribution  $G(\cdot)$ ? If it plays according to  $F$  and doesn't list, then we know from Chapter 1, Result 4 that its equilibrium profits will be:  $\pi_i = \frac{1}{2}(1 + \sqrt{2})\varepsilon$ . To show that the baseline equilibrium collapses it will be sufficient to find a single price  $p_i$  which if listed on the PCW and played against  $F(p_j)$  will yield a larger profit than  $\frac{1}{2}(1 + \sqrt{2})\varepsilon$ . Consider the profit maximisation problem facing firm  $i$  if it decides to list and offer a price of  $p_i$ :

$$\max_{p_i} \pi_i(p_i) = (p_i - t) \cdot \Pr[p_i \leq p_j + \varepsilon] \quad (1)$$

That is, given that firm  $j$  is not listing, in order for firm  $i$  to sell to the consumers it must not be more than  $\varepsilon$  more expensive. Furthermore, if it does succeed in selling to the consumers at price  $p_i$ , it must pay a commission  $t$  on each sale. It is easy to see that we can rewrite (1) as:

$$\begin{aligned} \max_{p_i} \pi_i(p_i) &= (p_i - t) \cdot (1 - \Pr[p_j \leq p_i - \varepsilon]) \\ &= (p_i - t) \cdot (1 - F(p_i - \varepsilon)). \end{aligned}$$

Our knowledge of  $F(\cdot)$  means that:

$$F(p_i - \varepsilon) = \begin{cases} 1 - \frac{(1 + \sqrt{2})\varepsilon}{p_i}, & p_i \in [(1 + \sqrt{2})\varepsilon, (2 + \sqrt{2})\varepsilon] \\ 2 \left[ 1 - \frac{(1 + \sqrt{2})\varepsilon}{2(p_i - 2\varepsilon)} \right], & p_i \in [(2 + \sqrt{2})\varepsilon, (3 + \sqrt{2})\varepsilon] \end{cases}$$

We have then that firm  $i$ 's profits vary with  $p_i$  according to:

$$\pi_i(p_i) = \begin{cases} (p_i - t) \frac{(1 + \sqrt{2})\varepsilon}{p_i}, & p_i \in [(1 + \sqrt{2})\varepsilon, (2 + \sqrt{2})\varepsilon] \\ (p_i - t) \left[ \frac{(1 + \sqrt{2})\varepsilon}{p_i - 2\varepsilon} - 1 \right], & p_i \in [(2 + \sqrt{2})\varepsilon, (3 + \sqrt{2})\varepsilon] \end{cases}$$

Taking the derivative gives us that

$$\pi_i'(p_i) = \begin{cases} \frac{(1 + \sqrt{2})\varepsilon}{p_i} \left( \frac{t}{p_i} \right), & p_i \in [(1 + \sqrt{2})\varepsilon, (2 + \sqrt{2})\varepsilon] \\ \left( \frac{(1 + \sqrt{2})\varepsilon}{p_i - 2\varepsilon} \left( \frac{t - 2\varepsilon}{p_i - 2\varepsilon} \right) - 1 \right), & p_i \in [(2 + \sqrt{2})\varepsilon, (3 + \sqrt{2})\varepsilon] \end{cases}$$

Notice that the expression on the top is always positive and that so long as  $t \leq 2\varepsilon + \frac{(p_i - 2\varepsilon)^2}{(1 + \sqrt{2})\varepsilon}$ , the expression on the bottom is negative. For the moment let us assume that  $t \leq 2\varepsilon$ . This would mean that  $p_i = (2 + \sqrt{2})\varepsilon$  yields maximal profits for firm  $i$  against the baseline equilibrium. In particular, maximal profits from listing would be  $\frac{1 + \sqrt{2}}{2 + \sqrt{2}}((2 + \sqrt{2})\varepsilon - t)$  which is strictly larger than baseline profits  $\frac{1}{2}(1 + \sqrt{2})\varepsilon$  so long as  $t < \frac{1}{2}(2 + \sqrt{2})\varepsilon$ . Finally, we argue that if the baseline equilibrium survives when  $t \in \left[ \frac{1}{2}(2 + \sqrt{2})\varepsilon, 2\varepsilon \right]$ , then it must also survive for  $t > 2\varepsilon$ , since increases in the commission payment unambiguously make listing less attractive. QED

### 3 OPTIMAL FIRM BEHAVIOUR

#### 3.1 PURE STRATEGIES AND CONTINUOUS ACTIONS

In this subsection we consider the strategic incentives facing firms when they are restricted to only pure strategies and their action space is a continuous interval. This allows us to find the

pure-strategy Nash equilibria of the game as well as characterise the circumstances in which there will not exist a pure-strategy equilibrium.

Let  $p_i^L$  denote that firm  $i$  lists the price  $p_i$  on the PCW and  $p_i^U$  denote that firm  $i$  is unlisted and charges the price  $p_i$ . Suppose that firm  $j$  plays  $p_j^L$ , what is firm  $i$ 's best response? The diagram below shows proportion of consumers firm  $i$  is able to sell to if he prices in the different regions. The top range denotes unlisted prices while the bottom range denotes listed prices.

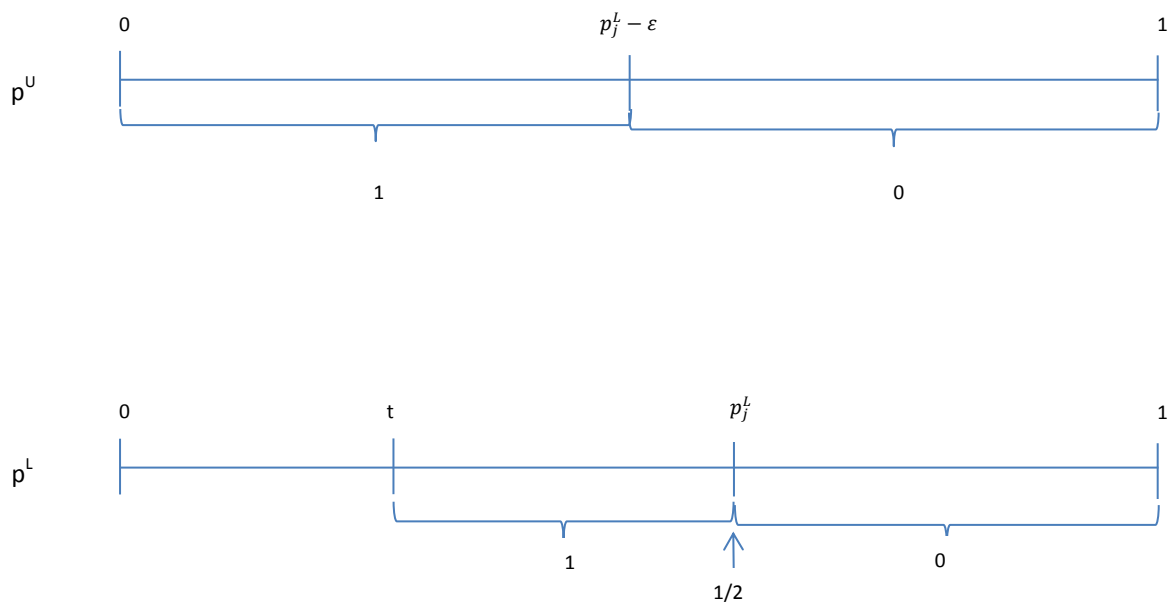

Figure 1: The proportion of consumers firm  $i$  can expect to attract at different prices relative to firm  $j$ .

We can see that if both firm  $i$  and firm  $j$  list, firm  $i$  will attract no consumers if it is more expensive than firm  $j$ ; all of the consumers if it is cheaper than firm  $j$ ; and they split the market if they offer the same price. If, however, firm  $i$  does not list then it is immediately at a disadvantage since all of the consumers will initially visit firm  $j$  on the comparison site and they will only purchase from firm  $i$  if it is more than  $\epsilon$  cheaper than firm  $j$ .

Inspecting Figure 1 we see that there are three potential ways that firm  $i$  may wish to best respond:



- (a) List and just undercut (LU): This involves listing and offering a price slightly below  $p_j^L$ . Notice that whatever price firm i chooses which is less than  $p_j^L$ , there is always some price slightly higher which does strictly better. For this reason the best response is the empty set  $\emptyset$  in this case. Firm i is able to earn profits arbitrary close to, but less than  $\pi_i^{LU} = p_j^L - t$ .
- (b) Unlist and undercut (UU): This involves not listing and offering a price slightly below  $p_j^L - \varepsilon$ . Notice that whatever price firm i chooses which is less than  $p_j^L - \varepsilon$ , there is always some price slightly higher which does strictly better. For this reason the best response is also the empty set  $\emptyset$  in this case. Firm i is able to earn profits arbitrary close to, but less than  $\pi_i^{UU} = p_j^L - \varepsilon$ .
- (c) List and match (LM): This involves listing and offering the same price as the competitor firm. The best response in this case can be expressed as  $BR_i(p_j^L) = p_j^L$ . Firm i is able to earn profits equal to  $\pi_i^{LM} = \frac{1}{2}(p_j^L - t)$ .

Clearly LM is dominated by LU for almost all  $p_j^L$ . This is because for an arbitrarily small decrease in price, firm i is able to sell to all of the consumers instead of only half. The exception is when  $p_j^L = t$ . Here, LM will do better than LU since LM will earn zero profits while LU will earn negative profits. Comparing profits between LU and UU:

$$\begin{aligned}\pi_i^{LU} &\geq \pi_i^{UU} \\ \Leftrightarrow p_j^L - t &\geq p_j^L - \varepsilon \\ \Leftrightarrow \varepsilon &\geq t\end{aligned}$$

That is, whether firm i prefers to list and undercut or unlist and undercut when their opponent is listing depends on whether the search cost is greater than or less than the commission payment. This is intuitive, since, if the search cost is relatively small it makes it easier to attract consumers by unlisting and offering a lower price compared to the competitor firm. Below are firm i's best responses to firm j offering different listed prices in two cases.

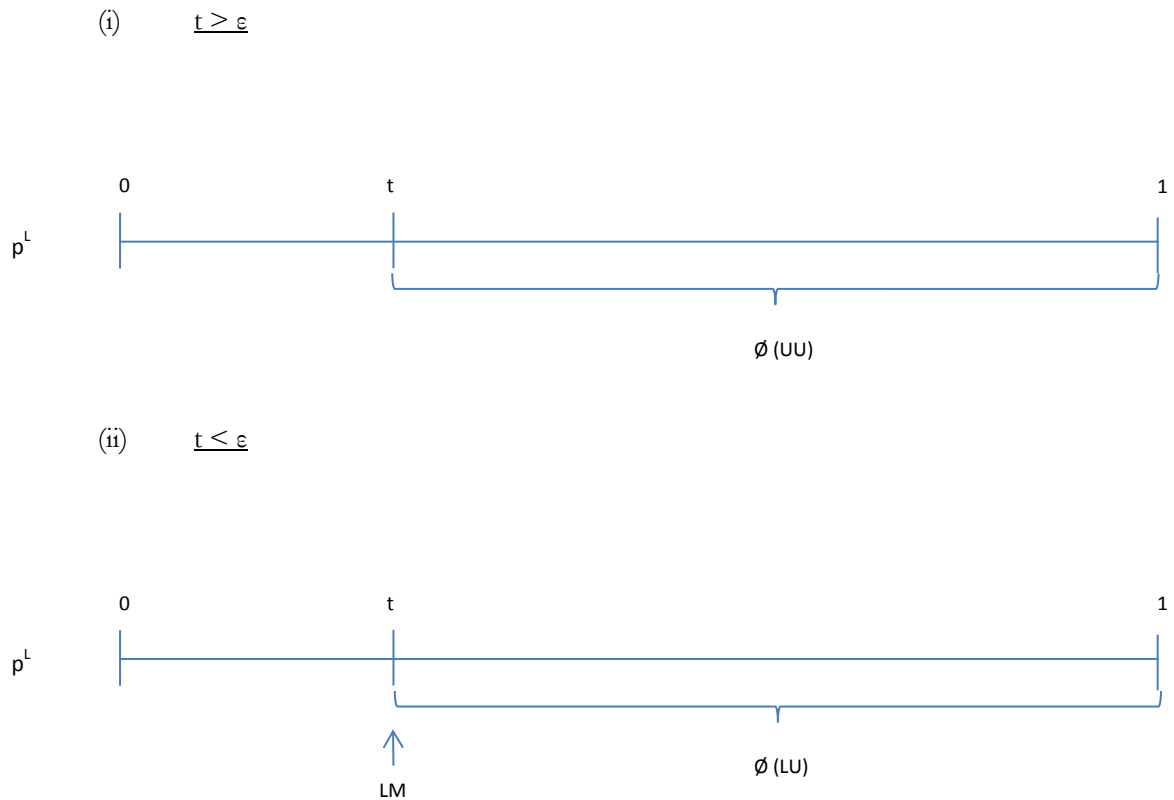

Figure 2: Firm i's best responses to firm j offering different listed prices.

In case (i) there is no best response. In case (ii) there is no best response except when firm j offers the price  $t$ . In this case, firm i's best response is to also list and match its competitor's price. Without even considering best responses to unlisted prices it is straightforward to see that both firms listing and offering the price  $t$  in case (ii) above will be a symmetric pure strategy Nash equilibrium.

**Result 2:** *There is a pure-strategy Nash equilibrium where both firms list and charge  $p_t^L = p_j^L = t$  as long as  $t \leq \varepsilon$ .*

**Proof:** This is trivially true since both firms listing and offering the price  $t$ , are mutual best responses. QED

Now we consider best responses to unlisted prices. Suppose that firm j offers the unlisted price  $p_j^U$ . The diagram below shows the proportion of consumers firm i is able to sell to if it prices in the different regions:

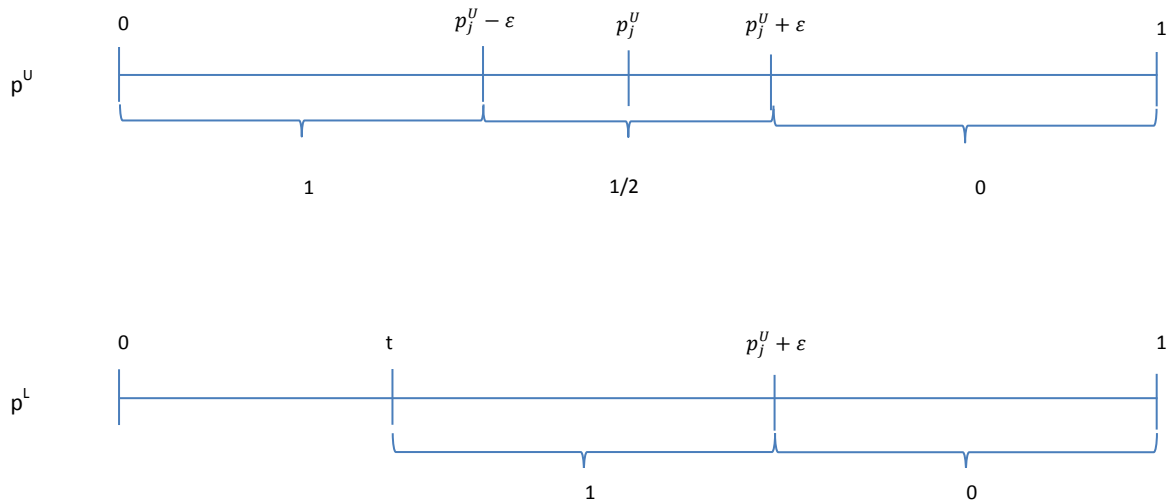

Figure 3: The proportion of consumers firm  $i$  is able to sell to if he prices in the different regions relative to firm  $j$ 's unlisted price.

That is, given that firm  $j$  unlists and offers a price of  $p_j^U$ , if firm  $i$  also unlists, the proportion of consumers it will sell to depends on how 'far away' its price is from  $p_j^U$ . If its price is within  $\varepsilon$  of its competitor, they will share the market equally. If its price is more than  $\varepsilon$  greater then it will lose all of its consumers; and if its price is more than  $\varepsilon$  less than its competitor, it will attract all of the consumers. If, however, firm  $i$  decides to list, it is able to attract all of the consumers so long as its price is not more than  $\varepsilon$  greater than its competitor. This is because all of the consumers first check the comparison site and will observe its price. They will only purchase from an unlisted competitor if it is more than  $\varepsilon$  cheaper than the price available on the comparison site.

Inspecting Figure 3 we see that there are three potential ways that firm  $i$  may wish to best respond:

- (a) List and 'exploit' (LE). That is, charge the highest listed price which retains the customers:  $p_i^L = p_j^U + \varepsilon$ , in which case  $\pi_i^L = p_j^U + \varepsilon - t$ .
- (b) Unlist and undercut (UU). That is, charge an unlisted price sufficiently low in order to just attract all the consumers. Notice that whatever price firm  $i$  chooses which is less

than  $p_j^U - \varepsilon$ , there is always some price slightly higher which does strictly better. For this reason, if UU does better than the other options, the best response is the empty set  $\emptyset$  in this case. Firm i is able to earn profits arbitrary close to, but less than  $\pi_i^{UU} = p_j^U - \varepsilon$ .

- (c) Unlist and exploit (UE). That is, charge the highest price which still sells to half of the consumers:  $p_i^{UE} = p_j^U + \varepsilon \Rightarrow \pi_i^{UE} = \frac{1}{2}(p_j^U + \varepsilon)$ .

Comparing profits pairwise:

$$\pi_i^{LE} \geq \pi_i^{UU}$$

$$2\varepsilon \geq t$$

$$\pi_i^{LE} \geq \pi_i^{UE}$$

$$p_j^U \geq 2t - \varepsilon$$

$$\pi_i^{UU} \geq \pi_i^{UE}$$

$$p_j^U \geq 3\varepsilon$$

We proceed by considering firm i's best response to firm j offering an unlisted price in three cases, (i)  $t \leq \varepsilon$ , (ii)  $t \in (\varepsilon, 2\varepsilon)$ , and (iii)  $t \geq 2\varepsilon$ .

Case (i):  $t \leq \varepsilon$ :

Our pairwise comparison shows that in this case, LE dominates UU. This makes sense, listing is relatively cheap and search costs are relatively large. A firm will have to offer a relatively large discount in order to undercut his competitor if he decides to unlist. Since UU is dominated, the comparison which matters is that between LE and UE. We see that LE does better for firm i when firm j is offering a price greater than  $2t - \varepsilon$ , while UE does better for lower prices.



Figure 4: Firm i's best response to different unlisted prices of firm j.

We have to be slightly careful here since playing LE as a response to prices which are close to one implies offering a price greater than one. This cannot be optimal since the consumer will never purchase at a price greater than his reservation price. However, amending LE so that the listed price offered is equal to  $\min\{p_j^U + \varepsilon, 1\}$  solves this problem. Obviously this makes LE relatively less attractive; however, it is straightforward to check that in this case, the amended LE strategy still does better than the two alternatives. That is, if firm  $j$  offers an unlisted price greater than  $1 - \varepsilon$ , the profits from the amended strategies are:

$$\pi_i^{LE'} = 1 - t, \quad \pi_i^{UE'} = \frac{1}{2}, \quad \pi_i^{UU} = p_j^U - \varepsilon.$$

Notice that UE also needs amending in this case so that it does not involve offering a price greater than one. Comparing profits, LE' does better than UE' so long as  $t < \frac{1}{2}$ , this is consistent with Assumption 1. LE' does better than UU so long as  $p_j^U < 1 - t + \varepsilon$ . Since in this case  $t \leq \varepsilon$ , this must be true since firm  $j$  will not offer a price greater than one.

Case (ii)  $t \in (\varepsilon, 2\varepsilon)$ :

Again in this case LE dominates UU. Which means that the relevant comparison is again between UE and LE, however, in this case, for prices close to one, LE' is no longer the best response. This is because the critical value  $1 - t + \varepsilon$  is no longer greater than one.



Figure 5: Firm  $i$ 's best response to different unlisted prices of firm  $j$ .

Case (iii)  $t \geq 2\varepsilon$ :

Here, UU dominates LE, which means that the relevant comparison is between UU and UE.

The critical value is then  $3\varepsilon$ .



Figure 6: Firm i's best response to different unlisted prices of firm j.

Now that we have considered best responses to both listed and unlisted prices we can now put them together to give us a full picture of each case.

Case (i):  $t \leq \varepsilon$ :

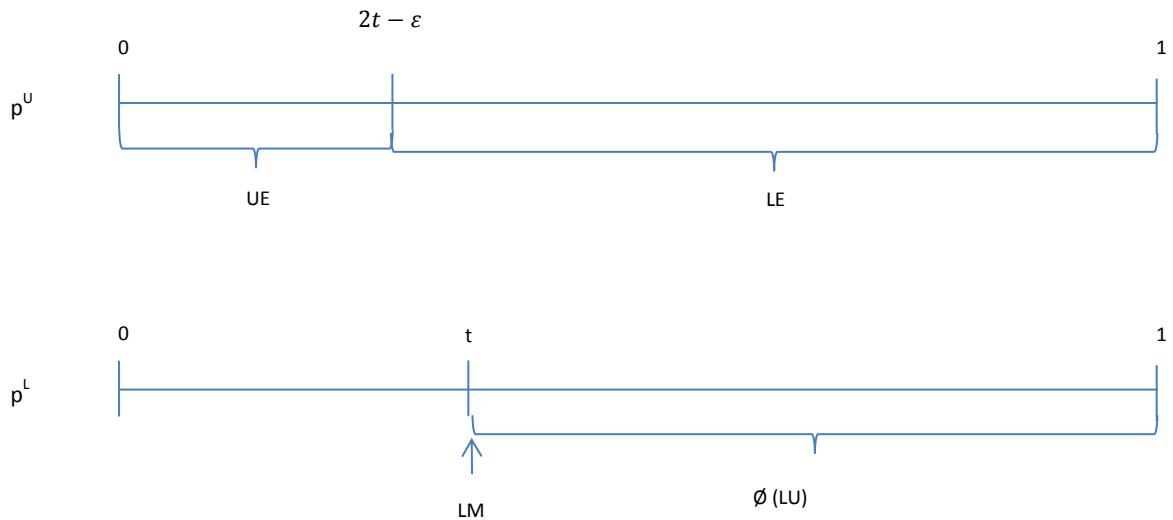

Figure 7: Firm i's best response to different listed and unlisted prices of firm j.

Inspecting Figure 7 it is clear that the pure-strategy Nash equilibrium that we found in Result 2 is the unique pure-strategy equilibrium in this case. Going through the possibilities we see that if firm i offers an unlisted price in the interval  $[0, 2t - \varepsilon]$ , firm j's best response is to offer an

unlisted price which is exactly  $\epsilon$  greater, from the interval  $[\epsilon, 2t]$ . These cannot be mutual best responses since the best responses to unlisted prices in the interval  $[\epsilon, 2t]$  are listed prices. Similarly, if firm  $i$  chooses the unlisted price  $p_i^U \in [2t - \epsilon, 1]$ , firm  $j$ 's best response will be a listed price  $p_j^L \in [2t, 1]$ . These cannot be mutual best responses since there is no best response to listed prices in the interval  $[2t, 1]$ . Finally, if firm  $i$  chooses a listed price in the interval  $(t, 1]$ , then there is no best response for firm  $j$ . This exhausts all other possibilities for a pure-strategy Nash equilibrium.

Case (ii)  $t \in (\epsilon, 2\epsilon)$ :

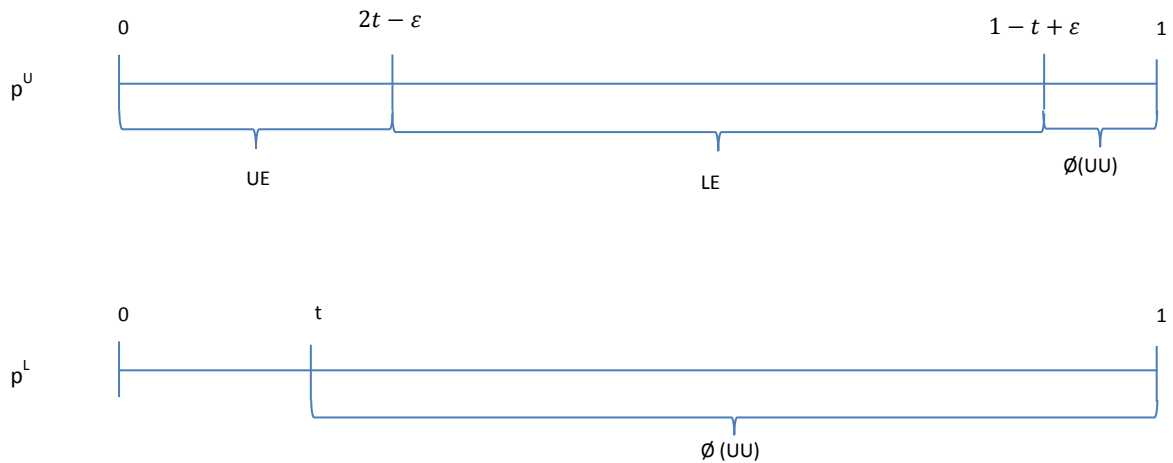

Figure 8: Firm  $i$ 's best response to different listed and unlisted prices of firm  $j$ .

Inspecting Figure 8 we see that in this case there is no pure-strategy Nash equilibrium. For example if firm  $i$  offers an unlisted price in the interval  $[0, 2t - \epsilon]$  then firm  $j$ 's best response is to offer an unlisted price which is exactly  $\epsilon$  greater, from the interval  $[\epsilon, 2t]$ . These cannot be mutual best responses since the best responses to unlisted prices in the interval  $[\epsilon, 2t]$  are either listed prices (if  $p_j^U \leq 1 - t + \epsilon$ ), or the null set (if  $p_j^U > 1 - t + \epsilon$ ). Similarly, if firm  $i$  chooses an unlisted price in the interval where LE is the best response, firm  $j$  will choose to list, however there is no pure-strategy best response to any listed price. There is no best response to prices offered in the remaining two regions where firms may wish to offer prices. This shows that there does not exist a pure-strategy Nash equilibrium in this case. Notice in particular, that the

equilibrium in Result 2 does not apply here since there is no best response to  $p_i^L = t$ , whereas in case (i) the best response was to match the price.

Case (iii)  $t \geq 2\varepsilon$ :

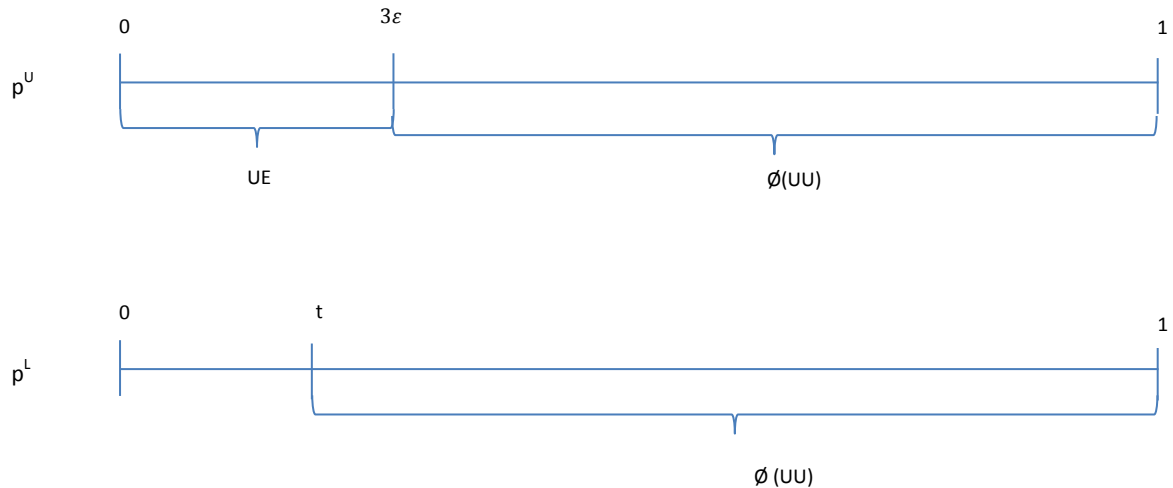

Figure 9: Firm i's best response to different listed and unlisted prices of firm j.

In this case there is also no pure-strategy Nash equilibrium. In two of the regions where firms may offer prices there is no best response in pure-strategies and in the final region, UE is the best response, however it is easy to see that there will be no mutual best responses in this case.

### 3.2 PURE STRATEGIES AND DISCRETE ACTIONS

In this subsection we still constrain firms to playing only pure strategies, however, now their action space is discrete. This will allow us to analyse the pure-strategy dynamics of the game. We make our standard assumption that the interval between prices  $\delta > 0$ , is very small and that all critical values can be expressed as an exact integer multiple of  $\delta$ . We proceed by going through three cases.

Case (i):  $t \leq \varepsilon$ :

In this case the commission fee is less than the search cost. Firm i's best response to firm j offering a listed price  $p_j^L$  can be expressed as follows:



$$BR_i(p_j^L) = p_i^L = \begin{cases} p_j^L - \delta, & p_j^L > t \\ p_j^L, & p_j^L = t \end{cases}$$

That is, firm  $i$ 's best response also involves listing. If firm  $j$ 's listed price is more than the commission fee, firm  $i$ 's best response involves just undercutting its competitor by offering the nearest available lower price. If, however, firm  $j$ 's listed price is equal to the commission fee, then, for firm  $i$ , matching its competitor's price does better than undercutting. This is because matching firm  $j$ 's price in this instance will yield zero profits, while undercutting firm  $j$ 's price will yield negative profits. Notice that these best responses are exactly the discrete price analogues of the best responses we found in the previous subsection. The discrete action space means that the response 'list and undercut' is now well defined. The intuition for why this is the best response is identical to the previous subsection, for this reason we do not repeat it here.

If firm  $j$  offers an unlisted price  $p_j^U$ , firm  $i$ 's best responses are either to list and exploit or unlist and exploit:

$$BR_i(p_j^U) = \begin{cases} p_i^{LE} = \min\{p_j^U + \varepsilon, 1\}, & p_j^U \geq 2t - \varepsilon \\ p_i^{UE} = p_j^U + \varepsilon, & p_j^U < 2t - \varepsilon \end{cases}$$

To ensure that playing LE does not involve offering a price greater than one, it takes the form above. These best responses are identical to the continuous action case. This is because they were already well defined in the absence of a discrete action space. Now that we have well defined best responses for both listed and unlisted prices we can represent the pure-strategy dynamics. An arrow shows the direction in which the price will move if one firm prices in a particular region and the other firm best responds.

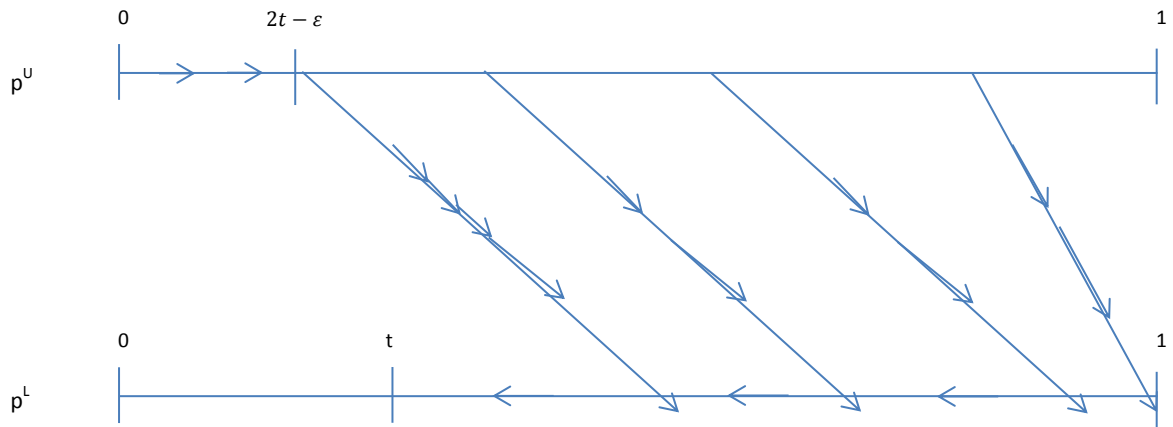

Figure 10: The pure strategy dynamics in case (i).

The dynamics make it clear that whatever prices we start at, the pure strategy dynamics converge to an equilibrium which corresponds to the equilibrium found in Result 2, in which firms offer prices according to:<sup>16</sup>

$$p_i^L = p_j^L = t$$

In equilibrium, both firms list and charge a price equal to the commission fee. Both firms make zero profit and all consumers purchase through the PCW, which makes a commission on each sale. The PCW is effectively able to extract all of the profit in this equilibrium and earns profits equal to:

$$\pi_{PCW} = t$$

This is clearly increasing in  $t$ . Since  $t \leq \epsilon$ , the highest commission fee that can be charged whilst retaining this equilibrium is  $t = \epsilon$ . This will yield profits equal to:

$$\pi_{PCW}^* = \epsilon.$$

<sup>16</sup> If search costs and commission are sufficiently large ( $>0.5$ ) there is an equilibrium where both firms unlist and charge the monopoly price. Assumption 1 rules this out.

This is precisely the equilibrium that we found in pure strategies and it is a candidate for a subgame perfect Nash equilibrium (SPNE). In order for it to be a SPNE we need to continue our analysis and check that there are no other equilibria which yield higher profits for the PCW.

Case (ii):  $t \in (\varepsilon, 2\varepsilon)$ :

Again, the best responses in this case are analogous to those in the continuous action case. However, now, undercutting is well defined.

$$BR_i(p_j^L) = p_i^{UU} = p_j^L - \varepsilon - \delta$$

$$BR_i(p_j^U) = \begin{cases} p_i^{UE} = p_j^U + \varepsilon, & p_j^U \leq 2t - \varepsilon \\ p_i^{LE} = p_j^U + \varepsilon, & p_j^U \in [2t - \varepsilon, 1 - t + \varepsilon] \\ p_i^{UU} = p_j^U - \varepsilon - \delta, & p_j^U > 1 - t + \varepsilon \end{cases}$$

That is, if firm j decides to list, firm i best responds by unlisting and undercutting. While if firm j decides to unlist, firm i's best response may involve listing or unlisting, which one depends on the unlisted price that firm j chooses. Our next result allows us to analyse the pure-strategy dynamics.

**Result 3:** *There is no equilibrium in pure strategies but as  $\delta \rightarrow 0$  the rationalisable pure strategies tend to (discrete) prices in the intervals:*

$$p^u \in [2t - \varepsilon, 2t], \quad p^L \in [2t, 2t + \varepsilon]$$

**Proof:** We show this by considering the pure-strategy dynamics. As we have previously argued, if an infinite cycle of prices occurs then every price in that cycle will be rationalisable. We break the dynamics into three stages, but first we will argue that whatever initial price a firm offers eventually the pure-strategy dynamics will enter the region

$$p^u \in [2t - \varepsilon, 2t], \quad p^L \in [2t, 2t + \varepsilon]$$

Consider what follows one of the firms offering an unlisted price less than  $2t - \varepsilon$ : the other firm will best respond by also offering an unlisted price, but one which is  $\varepsilon$  greater than its

competitor. If this unlisted price is also less than  $2t - \epsilon$ , the other firm will also wish to offer a higher unlisted price. This will put upward pressure on prices until at some point an unlisted price  $p^u \in [2t - \epsilon, 2t]$  will be offered. Similar reasoning for any other initial price will also eventually lead to a price being offered in the required intervals. The figure below shows the pure strategy dynamics. An arrow shows the direction in which the price will move if one firm prices in a particular region and the other firm best responds.

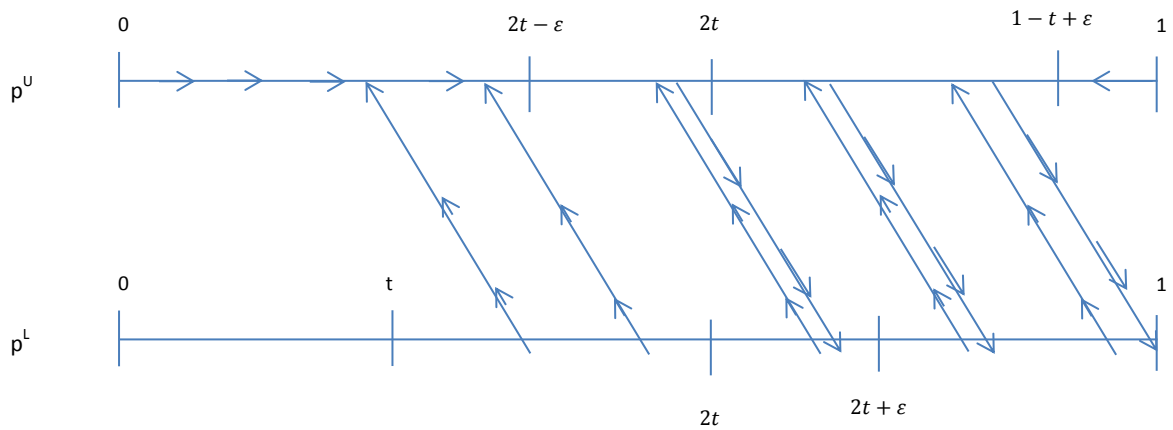

Figure 11: The pure strategy dynamics in case (ii).

Notice that if one of the firms offers a listed price close to one, the other firm best responds by unlisting and undercutting. The two firms proceed by engaging in ‘quasi-bertrand’ competition i.e. whilst keeping their listing status fixed, they keep just undercutting each other while keeping an  $\epsilon$  distance between their prices. Eventually the price path will enter the required interval. Now that we are satisfied that the price path must enter the required intervals we show that the price path will cycle through these prices. In stage 1, consider that firm  $i$  offers the listed price  $2t + \epsilon$ , firm  $j$  will respond by unlisting and undercutting, and offer the price  $2t - \delta$ . Firm  $i$  will respond by continuing to list but lowering his price by  $\delta$  to  $2t + \epsilon - \delta$ . Now, firm  $j$  will also wish to reduce its price by  $\delta$  while continuing to unlist, they continue in this ‘quasi-Bertrand’ fashion until firm  $j$  lowers its price to  $2t - \epsilon$ . This is the end of stage 1. In stage 2, firm  $i$  is now indifferent between the strategies ‘unlist and exploit’ and ‘list and exploit’ and switches from listing to unlisting and offering a price of  $2t$ , but this now leads to firm  $j$  wishing to switch from unlisting to listing and charge  $2t + \epsilon$  (stage 3).

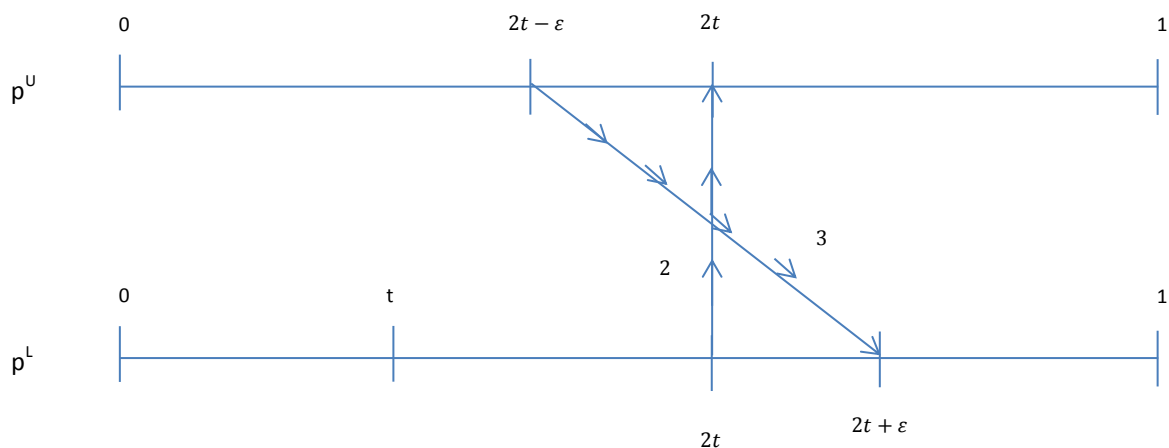

Figure 12: Stage 2 and 3 in the pure-strategy dynamics.

This completes the cycle and firms return to stage 1 where they continue to just undercut one other, whilst keeping an  $\epsilon$  distance between their prices. Notice that firm  $i$  and  $j$  alternate between being the listed and unlisted firm in stage 1.

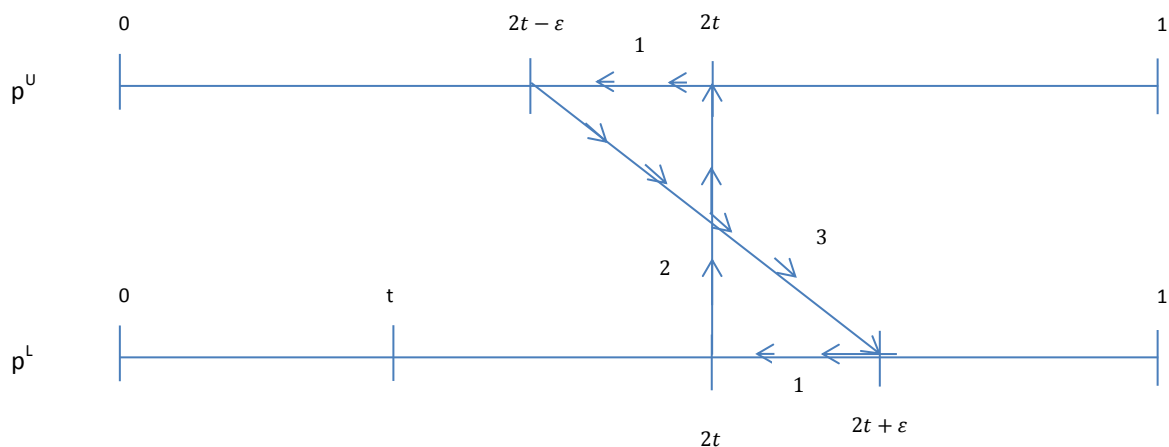

Figure 13: The pure strategy dynamics in case (ii).

QED

Recall that we were led to all previous equilibria that we have found by looking first at what happened to the pure strategy dynamics of the game. For instance, in earlier chapters, we found that firms prices would cycle in some interval of length  $\epsilon$  or  $2\epsilon$  and then exploited this to find the mixed-strategy equilibrium where firms offered atomless price distributions which

randomised over intervals of these lengths (even if the continuous action mixed equilibrium did not play exactly the same prices as those which were rationalisable in the discrete action pure-strategy game). We were hoping to find a similar mixed strategy equilibrium in this case. That is, one with the following structure: firms randomise by sometimes playing unlisted prices on some interval  $[a, a + \varepsilon]$  and listed prices on the interval  $[a + \varepsilon, a + 2\varepsilon]$ . However, there does not exist a mixed equilibrium with this structure.<sup>17</sup> This does not mean there does not exist any equilibrium but unfortunately we are unable to prove one way or another. We now move on to the final case when the commission fee is greater than twice the search cost.

Case (iii):  $t > 2\varepsilon$ :

Again, the best responses are analogous to the continuous action case, the difference being that now ‘unlist and undercut’ is well defined:

$$BR_i(p_j^L) = p_i^{UU} = p_j^L - \varepsilon - \delta$$

$$BR_i(p_j^U) = \begin{cases} p_i^{UE} = p_j^U + \varepsilon, & p_j^U \leq 3\varepsilon \\ p_i^{UU} = p_j^U - \varepsilon - \delta, & p_j^U > 3\varepsilon \end{cases}$$

Notice that whatever price is offered by firm  $j$ , firm  $i$  never wishes to list. This makes sense since now listing is relatively expensive and there will always exist an unlisted price which does better than every listed price for all possible prices offered by an opponent. Since it is never a best response to list, this case collapses to our baseline case in Chapter 1.

---

<sup>17</sup> The proof of this is omitted.

We can see this clearly from the pure-strategy price dynamics:

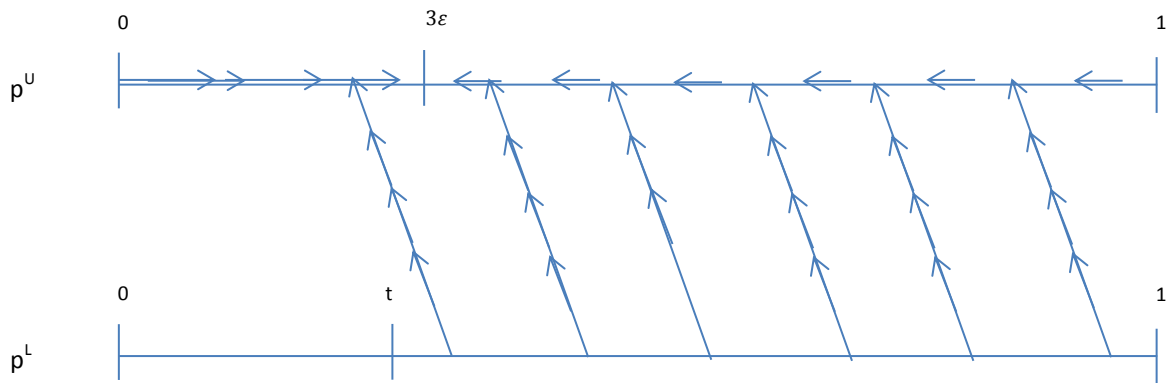

Figure 14: The pure strategy dynamics in case (iii).

As in the baseline case iteratively deleting strategies which are never a best response leaves us with the familiar interval  $[2\varepsilon, 4\varepsilon]$ .

**Result 4:** *When  $t > 2\varepsilon$ , there is no equilibrium in pure strategies but as  $\delta \rightarrow 0$  the rationalisable pure strategies tend to those (discrete) unlisted prices in the interval  $[2\varepsilon, 4\varepsilon]$ .*

**Proof:** Once we rule out listed prices as never a best response, the proof is identical to that in Chapter 1, Result 2. QED

To summarise what we have found, when  $t \leq \varepsilon$ , there is a pure-strategy equilibrium where both firms list and charge a price equal to the commission fee  $t$ , out of all of these equilibria the one which makes the most profit for the PCW is when the commission fee is chosen to exactly equal the search cost,  $t = \varepsilon$ . This equilibrium holds in both the continuous-action and discrete-action game.

When  $t \in (\varepsilon, \frac{1}{2}(2 + \sqrt{2})\varepsilon)$ , we have shown that there is no pure strategy equilibria in either the continuous-action or discrete-action game. There may or may not be mixed strategy equilibria in the continuous-action game.<sup>18</sup> After an exhaustive search, my intuition is that in the continuous-action game, there does not exist any equilibria but I am unable to prove it.

<sup>18</sup> We know that there must be a mixed-strategy equilibrium in the discrete action game since it is a basic result that when players' action sets are finite there must exist at least one Nash equilibrium. The reason why we do not attempt to characterise this equilibrium is that – for us – the purpose of analysing the

Finally, if  $t \geq \frac{1}{2}(2 + \sqrt{2})\varepsilon$ , there is no equilibria in pure-strategies, however, the baseline equilibrium where both firms unlist and play according to the symmetric mixed strategy remains an equilibrium:

$$F(p_i) = \begin{cases} 1 - \frac{(1 + \sqrt{2})\varepsilon}{p_i + \varepsilon}, & p_i \in [\sqrt{2}\varepsilon, (1 + \sqrt{2})\varepsilon] \\ 2 \left[ 1 - \frac{(1 + \sqrt{2})\varepsilon}{2(p_i - \varepsilon)} \right], & p_i \in [(1 + \sqrt{2})\varepsilon, (2 + \sqrt{2})\varepsilon] \end{cases}$$

In this equilibrium no sales are made through the PCW, hence it must be that the price comparison site makes zero profits in this case  $\pi_{PCW} = 0$ . Of all the equilibria that we have found, the one that yields that PCW the highest profits is when the commission fee is chosen to equal the search cost exactly. Here, both firms decide to list and offer a price equal to the commission fee/search cost, they make zero profit in equilibrium. The PCW is able to extract the total price paid by the consumer to the firm as profit. This is a candidate for the subgame perfect Nash equilibrium, however since we are unable to rule out the possibility that there exists some other equilibrium that yields the PCW higher profits, we cannot make this claim.

#### 4 THE DECEPTIVE COMPARISON SITE

So far we have always assumed that the PCW is truthful in the sense that it truthfully reveals the prices that have been posted on its site by firms. Suppose however that the comparison site is ‘deceptive’ in the sense that it does not always reveal all the prices. In particular, suppose that it reveals firm  $i$ ’s price only with probability  $\theta$ , firm  $j$ ’s price only with probability  $\theta$ , and both prices with the remaining probability,  $1 - 2\theta$ . We assume that consumers are all informed of the PCW and that they are naïve in the sense that they assume that the comparison site is fully revealing the available prices in the market. Due to this, if they make a purchase at all, they make it through the PCW. We assume that no commission fee is payable by the firms to the comparison site, however, we analyse the possibility of the firms and the PCW colluding in this

---

discrete action game is purely to analyse the dynamic incentives firms face with the hope that any resulting price cycles would help us to find the mixed strategy equilibrium of the continuous action game.



way and consider how much the firms would be willing to pay the PCW to engage in this deception.

Consider the expected profit to firm  $i$  if it offers price  $p_i$  and its opponent offers the price  $p_j$ :

$$\mathbb{E}[\pi_i(p_i, p_j)] = \begin{cases} \theta p_i, & \text{if } p_i > p_j \\ \left(\theta + \frac{1}{2}(1 - 2\theta)\right) p_i, & \text{if } p_i = p_j \\ (1 - \theta) p_i, & \text{if } p_i < p_j \end{cases}$$

That is, if firm  $i$  is more expensive than firm  $j$ , consumers will only purchase from firm  $i$  in the state of the world where firm  $i$ 's is the only listed price, which occurs with probability  $\theta$ . If firm  $i$ 's price is equal to firm  $j$ 's, then it is able to sell to all of the consumers when its price is the only listed price; and half of the consumers when both prices are listed. If firm  $i$  is cheaper than firm  $j$  then it will sell to all the consumers except in the state of the world where only its opponent's price is listed.

Simplifying expected profits, we have:

$$\mathbb{E}[\pi_i(p_i, p_j)] = \begin{cases} \theta p_i, & \text{if } p_i > p_j \\ \frac{1}{2} p_i, & \text{if } p_i = p_j \\ (1 - \theta) p_i, & \text{if } p_i < p_j \end{cases}$$

If firm  $j$  offers the price  $p_j$ , we can show diagrammatically what proportion of consumers in expectation firm  $i$  will be able to sell to if it offers a price in different regions:

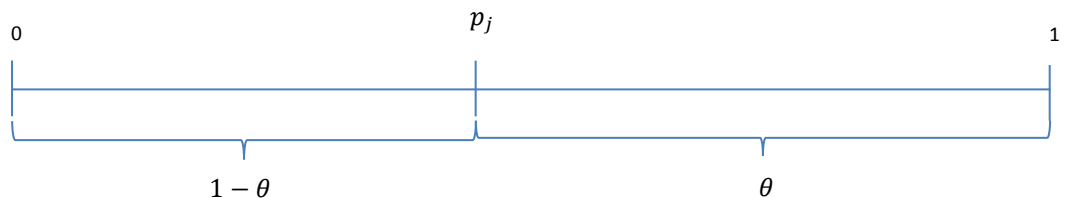

Figure 15: The proportion of consumers in expectation firm  $i$  will be able to sell to if he offers a price in different regions relative to firm  $j$ .

Suppose that firm  $i$  has decided that it would like to offer a higher price than its competitor. In this case it sells when only its price is listed. Thus, offering the monopoly price,  $p = 1$ , dominates all other prices in this range. We call this action (E)xploit. Profits in this case are  $\pi_i(E) = \theta$ . Alternatively, firm  $i$  could decide to offer a price lower than its competitor, in which case, in expectation, it will sell to  $1 - \theta$  of the consumers. Clearly if choosing this strategy it will want to offer a price as close as possible to its competitor's price. We call this action (U)ndercut. Profits from this strategy will yield profits arbitrarily close to, but less than  $\pi_i(U) = (1 - \theta)p_j$ . The third option is to (M)atch firm  $j$ 's price, this clearly yields profits equal to  $\pi_i(M) = \frac{1}{2}p_j$ . Now, since it must be that  $\theta \leq \frac{1}{2}$ , undercut dominates match except for when  $\theta = \frac{1}{2}$ . For this reason we rule out match as a best response. Comparing profits from exploit and undercut:

$$\pi_i(E) \geq \pi_i(U)$$

$$p_j \geq \frac{\theta}{1 - \theta}$$

Diagrammatically, we have firm  $i$ 's best response for all possible prices of firm  $j$ :

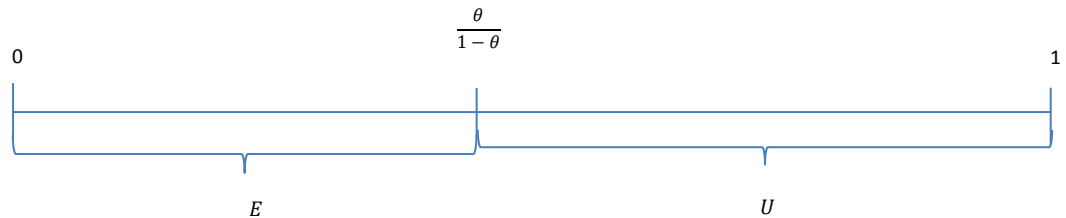

Figure 16: Firm  $i$ 's best response for all possible prices of firm  $j$ .

One can see that the pure-strategy dynamics of this game exhibits Edgeworth cycles where at high prices firms engage in Bertrand-type behaviour of undercutting one another until the price falls to the critical value  $\frac{\theta}{1-\theta}$ , at which point the price jumps to the monopoly price and the two firms proceed to undercut one another, and so on.<sup>19</sup>

<sup>19</sup> Clearly, for the best response 'undercut' to be well-defined we need a discrete action space.

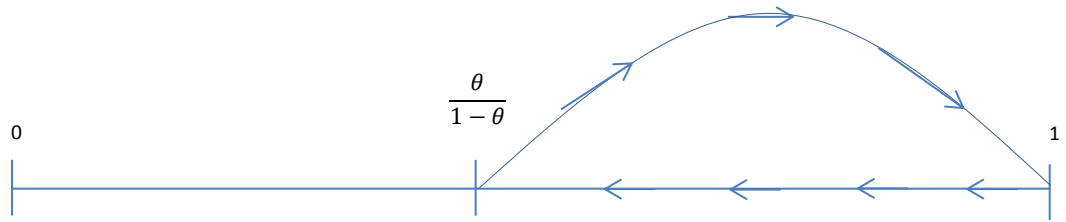

Figure 17: The pure strategy dynamics.

It is straightforward to see that there will not exist an equilibrium in pure strategies. However, there is an equilibrium in mixed strategies.

**Result 5:** *When firms can offer any price in the interval  $[0, 1]$ , there is a mixed strategy Nash equilibrium where firms offer prices according to*

$$F(p_i) = \frac{1}{1 - 2\theta} \left[ 1 - \theta - \frac{\theta}{p_i} \right], \quad p_i \in \left[ \frac{\theta}{1 - \theta}, 1 \right].$$

**Proof:** Suppose that firm  $j$  plays according to  $F$  on the interval, then if firm  $i$  offers a price  $p_i \in \left[ \frac{\theta}{1 - \theta}, 1 \right]$  its expected profit will be

$$\mathbb{E}[\pi_i(p_i, F)] = p_i \left[ \theta F(p_i) + (1 - \theta)(1 - F(p_i)) \right]$$

That is, with probability  $F(p_i)$ , firm  $j$  will offer a price lower than  $p_i$ , in which case, firm  $i$  will only be able to sell to the consumers in the state of the world where its price is the only displayed price, which occurs with probability  $\theta$ . Similarly, with probability  $1 - F(p_i)$ , firm  $j$ 's price is greater than  $p_i$ , in which case, firm  $i$  will sell to all of the consumers except in the case where its price is not listed, which occurs with probability  $1 - \theta$ . Setting expected profits in this interval equal to a constant  $\pi$ , and rearranging we have that

$$F(p_i) = \frac{1}{1 - 2\theta} \left[ 1 - \theta - \frac{\pi}{p_i} \right]$$

Using that  $F$  has full support on the interval and no mass points:

$$\begin{aligned}
F\left(\frac{\theta}{1-\theta}\right) &= 0 \\
\Rightarrow \frac{1}{1-2\theta} \left[1 - \theta - \pi \left(\frac{1-\theta}{\theta}\right)\right] &= 0 \\
\Rightarrow \pi &= \theta
\end{aligned}$$

Which is consistent with

$$\begin{aligned}
F(1) &= 1 \\
\Rightarrow \frac{1}{1-2\theta} [1 - \theta - \pi] &= 1 \\
\Rightarrow \pi &= \theta
\end{aligned}$$

Yielding

$$F(p_i) = \frac{1}{1-2\theta} \left[1 - \theta - \frac{\theta}{p_i}\right], \quad p_i \in \left[\frac{\theta}{1-\theta}, 1\right]$$

Finally, we argue that firm  $i$  cannot do better by offering a lower price outside of the support by noting that offering the price  $\frac{\theta}{1-\theta}$  is sufficiently low to guarantee that the competitor firm's price will be greater and thus sell to proportion  $(1 - \theta)$  of the consumers in expectation. Reducing one's price further is of no benefit when the other firm is playing according to  $F$  since it is not possible to sell to more than  $(1 - \theta)$  of the consumers in expectation even if a price of zero is offered. QED.

Notice that in this equilibrium, firms make profits equal to the probability that only one price is shown on the PCW,  $\theta$ . The larger  $\theta$  is, the more rent can be extracted from the consumer. Indeed, each firm would be willing to pay the PCW up to  $\theta$ , in order to deceive consumers in this way rather than to truthfully reveal both prices. This is because if both prices are always revealed, the two firms will engage in Bertrand competition which will yield them zero profits. From the point of view of the PCW and the firms, it makes sense to choose  $\theta$  as large as possible since this maximises the size of the surplus which they can split between themselves. In

particular if  $\theta = 1/2$  is chosen then the equilibrium entails both firms offering the monopoly price. This would involve full rent extraction from the consumer and this surplus of one, would presumably be split according to some bargaining process between the two firms and the PCW.

Another way of looking at the role of the PCW here is that it plays the role of a commitment device for the firms to offer high prices. What I mean is, in standard Bertrand competition firms make zero profit in equilibrium. If they could somehow coordinate and commit to offering the monopoly price then they could share the monopoly profits between themselves. This is not possible in standard Bertrand competition since firms have an incentive to undercut their competitor. However, if the two firms could come together and create a PCW which only lists one price ( $\theta = 1/2$ ) then they are able to credibly commit to offering the monopoly price. Of course, all this relies on the consumers being somewhat naïve and believing that the PCW is revealing all relevant information to them.

The other thing to notice is that in this model, the prices which the pure strategy dynamics cycles through (in the discrete action game) are exactly the same interval of prices which make up the support of the mixed strategy equilibrium (in the continuous action game) i.e.  $[\frac{\theta}{1-\theta}, 1]$ . We have seen that this cannot always be guaranteed to be the case e.g. in the baseline equilibrium, the pure strategy dynamics cycle through the prices in the interval  $[2\varepsilon, 4\varepsilon]$  while the mixed strategy equilibrium has support on the interval  $[\sqrt{2}\varepsilon, (2 + \sqrt{2})\varepsilon]$ . Nevertheless it is striking that even in this case; the length of the two intervals is identical. Throughout these past three chapters it is clear that there is some intimate link between the prices through which the pure strategy dynamics (or fictitious play) cycle through in the discrete action game and the prices which are played in the mixed strategy equilibrium of the continuous action game. Investigating this relationship may be a future avenue for research.

## 5 THE CASE OF THREE FIRMS

In this section we go back to the baseline model of Chapter 1 where there is no PCW and consumers are presented with a set of draws from price distributions but do not know which

draw is associated with which firm. We extend our analysis by looking at the strategic incentives firms face when there are three firms competing to sell a homogenous good. We are unable to find any equilibria but it is instructive to see how the three firms split the unit mass of consumers depending on the prices that they offer relative to one another.

Again, we consider a unit mass of consumers searching for the lowest price for one unit of a good which they value at  $v = 1$ , they do not know the prices at any given store until they visit but they do know the *realised* distribution of prices. Visiting a store incurs a search cost  $\epsilon$  for the consumer. There are now three firms – which we call  $\{i, j, k\}$  – each of whom can produce the good costlessly. This is all common knowledge.

### *Timing*

1. Firms simultaneously choose distributions from which their price will be drawn ( $F_i, F_j, F_k$ ).
2. Nature draws a single price ( $p_i, p_j, p_k$ ) from each distribution.
3. The consumer is presented with the set of prices ( $p_i, p_j, p_k$ ) but does not know which price is associated with which store.
4. Consumer engages in costly search (or not).

## **5.1 OPTIMAL CONSUMER SEARCH**

As we have previously noted, consumers are perfectly informed about the realisation of the prices in the marketplace but they are completely ignorant of which price is being offered in which store. Thus we assume that – if they search at all – they search randomly so that initially each firm receives one-third of the unit mass of consumers and consumers assign an equal probability to visiting a particular firm if they undertake an initial search (in this case, one-third). Consumers learn what the price being offered at the store that they happen to visit first is, and they update their beliefs about the other two prices, so they now assign a one-half probability of visiting a particular store (out of the two remaining firms) if they undertake an additional search.

On visiting the second store they learn the price being offered there and can also perfectly infer the price at the final store.

The first thing that we note is that if a consumer begins the search process, he will definitely make a purchase from one of the stores rather than end his search with no purchase. The intuition for this is clear: if he is willing to search at the start of the game, it must be that he will be willing to make a purchase if he arrives at, at least one of the stores. If he undertakes a search and arrive at one of the stores where he will be willing to make a purchase, then he will make a purchase. If however, he arrives at a store where he is not willing to make a purchase, he faces the prospect of paying an additional search cost in order to find the firm(s) where he is willing to purchase. The key thing to note is, this choice is more attractive than the previous choice since he now has a greater probability of visiting a store where he will be willing to purchase if he arrives. So we have the following observation:

**Observation 1:** *If a consumer is willing to make the initial search then he will definitely make a purchase at some point rather than end the search with no purchase.*

The next thing we note is that a consumer will never return to a store which he has already visited, for example, if a consumer visits firm  $j$  and then decides to search again, this time visiting firm  $k$ , he will then never return to firm  $j$ . The intuition for this is also clear: without loss of generality, consider that the consumer finds himself at firm  $j$  after his initial search and decides to search again, it must be that at least one of the prices  $(p_i, p_k)$  is attractive compared to  $p_j$ . If he searches and come across the attractive price – say at firm  $i$  – then he will purchase there, if however he finds a price at which he does not want to purchase – say at firm  $k$  – then he knows for sure that on his next search he can buy from firm  $i$ . This must be preferable to revisiting firm  $j$ , since if it were not he would have never undertaken an additional search when he found himself at firm  $j$ . Thus we have that:

**Observation 2:** *A consumer will never decide to return to a firm which he has already sampled in the past but decided not to make a purchase.*

We now look at the search decision in more detail. We restrict our attention to the non-trivial case where the consumer will wish to undertake the initial search. We know from our two observations that he will visit the stores sequentially, deciding to optimally end his search at one of the stores by making a purchase. Without loss of generality, suppose that a consumer arrives at firm  $i$  initially, he is now faced with a choice: make a purchase at the price  $p_i$  or pay a search cost in order to sample with equal probability from  $\{p_j, p_k\}$ . He knows that if he leaves firm  $i$  he will never return, so he reasons that if the prices  $\{p_j, p_k\}$  are more than  $\varepsilon$  apart, he will continue to search until he arrives at the cheaper of the two. This is because, in the state of the world where he visits the more expensive of the two he will prefer to pay an additional search cost to visit the other store since it is more than  $\varepsilon$  cheaper. If however, the other two prices are less than  $\varepsilon$  apart and he searches, he will purchase at the first store that he visits.

This leads to consumer search in two cases:

1.  $|p_j - p_k| > \varepsilon$  and  $p_i > \min\{p_j, p_k\} + \frac{3}{2}\varepsilon$
2.  $|p_j - p_k| < \varepsilon$  and  $p_i > \frac{1}{2}(p_j + p_k) + \varepsilon$

In the first case  $|p_j - p_k| > \varepsilon$ , which means that if the consumer searches he will continue to search until he finds the cheaper of the two prices, knowing this, under what condition will he choose not to purchase at store  $i$ ? Well precisely under the condition  $p_i > \min\{p_j, p_k\} + \frac{3}{2}\varepsilon$ . This is because if he searches he knows that he will end up paying the lower of the two prices i.e.  $\min\{p_j, p_k\}$  but he also needs to consider the expected search cost that he will incur: in this case  $\frac{3}{2}\varepsilon$  i.e. with probability half he will only search once and with probability half he will search twice. In the second case, the two prices are closer than  $\varepsilon$  apart so the consumer knows that if he undertakes a search he will purchase at the first store he visits. Knowing this, he will only choose not to purchase from the first store he arrives at if it is more expensive than the average of the two other prices  $\frac{1}{2}(p_j + p_k)$  plus the additional search cost, which will be  $\varepsilon$  for sure.



## 5.2 OPTIMAL FIRM BEHAVIOUR

When deciding what price to offer, firms need to consider the proportion of customers that will be attracted to them at different prices. We saw earlier that when there were two firms it was relatively simple to calculate the proportion of customers a firm would attract for each pair of prices  $(p_i, p_j)$ . With three firms things are complicated somewhat; the diagram below shows the proportion of consumers that firm  $i$  will sell to at a given price  $p_i$  as  $p_j$  and  $p_k$  vary.

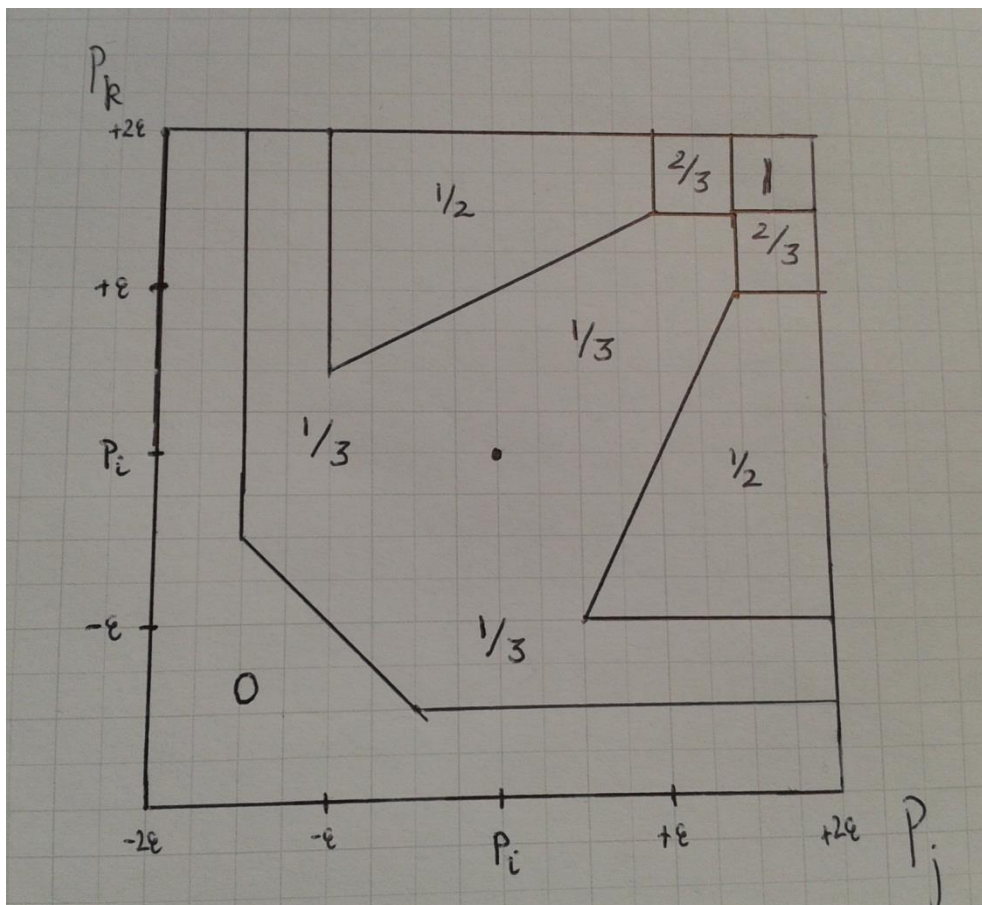

Figure 18: Proportion of customers who purchase from firm  $i$  as  $p_j$  and  $p_k$  vary relative to  $p_i$ .

The point in the centre of the diagram represents the case when  $p_i = p_j = p_k$ . Clearly no consumer will search beyond the first firm that they visit in this case, which is why this point is contained in the region where firm  $i$  is able to sell to one-third of the consumers. Moving to the right represents an increase in the price offered by firm  $j$  relative to  $p_i$ , while moving up represents an increase in the price offered by firm  $k$  relative to  $p_i$ . Of course, the game is

symmetric and so the diagram above (with subscripts changed) applies equally to all three firms. As we see, there are a number of possibilities for the proportion of consumers who buy from a firm:

- (i) Zero: in this region the consumers who initially visit firm  $i$  prefer to continue their search rather than purchase at firm  $i$ ; and equally, if a consumer who initially visited some other firm decides to search and happens to visit firm  $i$  they will continue their search by visiting the third firm.
- (ii) One-third: in this region, either, no search occurs and consumers purchase from the first store that they visit, or else, if some consumers do search and happen to visit firm  $i$ , they decide to continue their search and purchase from a third firm. Note that the one-third of consumers that firm  $i$  sells to in this case is always the same one-third who initially visit firm  $i$ .
- (iii) One-half: in this region the consumers who initially visit firm  $i$  decide not to search, however the consumers who initially visited one of the other firms decide to search (this represents one-third of consumers). Half of these searchers visit firm  $i$  and decide to end their search and the other half visit the remaining firm and decide to end their search. Thus firm  $i$  sells to the one-third of consumers who initially visit it as well as half of the one-third of consumers who search.
- (iv) Two-thirds: in this region the consumers who initially visit firm  $i$  decide not to search, however the consumers who initially visited one of the other firms decides to search (this represents one-third of consumers). Half of these searchers visit firm  $i$  and decide to end their search and the other half visit the remaining firm and decide to continue their search and purchase from firm  $i$ . Thus, firm  $i$  sells to the one-third of consumers who initially visit it as well as all of the one-third of consumers who search.
- (v) One: in this region the consumers who initially visit firm  $i$  decide not to search, however the consumers who initially visited either of the other two firms decide to search (this represents two-thirds of consumers). Half of these searchers visit firm  $i$

and decide to end their search. The other half, if they initially visited firm  $j$  visit firm  $k$  and decide to continue their search and purchase from firm  $i$ . While if they initially visited firm  $k$ , they decide to search and visit firm  $j$  and decide to continue their search and purchase from firm  $i$ . Thus firm  $i$  sells to the one-third of consumers who initially visit it as well as all of the two-thirds of consumers who search.

Finding the equilibria of this game is not straightforward, although it is apparent that there is no pure strategy equilibrium. We are unable to solve for any mixed strategy equilibria but note that one of the reasons that it is difficult to solve our model – even the baseline case – when there are more than two firms is because the search process involves sampling without replacement. Sampling without replacement is natural in our model since it means that when the consumer searches there is no chance of him accidentally returning to the store that he is currently at, or one that he has visited before. Nevertheless, it makes the consumer’s decision rule potentially very complicated when there are a large number of firms. The advantage of sampling with replacement is that the decision problem remains stationary, in that, the problem of choosing whether or not to search looks the same to the consumer no matter how many searches he has already undertaken. In that case the consumer’s decision rule would be to follow a standard cut-off rule.

## **6 CONCLUDING REMARKS**

In this chapter we allowed the comparison site to charge a commission. The equilibrium that we found was not particularly inspiring: both firms offer a listed price equal to the commission fee so long as the commission fee is less than the search cost. Nevertheless, when analysing the pure strategy dynamics we saw that firms would regularly switch between listing and unlisting, undercutting and exploiting. The resulting dynamics, while of interest, did not allow us to find a mixed-strategy equilibrium of the game. Next, we saw that the comparison site and the firm may have an incentive to collude and deceive the consumer by not always revealing all the prices. This has potential policy implications: authorities may wish to check that the prices listed

in comparison sites are not misleading. Finally, we analysed the incentives faced by firms and consumers in the case of three firms. Figure 18 shows how the pricing decisions of the three different firms interact and lead to the sharing of consumers in different and not always intuitive ways.

# CHAPTER 4: IMPERFECT RECALL AND TASK COMPLETION

## 1 INTRODUCTION

One of the 'conclusions' of the *Games and Economic Behaviour* special issue on imperfect recall is that there is no one way to model imperfect recall in games; in particular, modelling issues which are of little or no consequence in games of perfect recall suddenly become substantive in games of imperfect recall.<sup>20</sup> Furthermore, there is little consensus on how to proceed. In this chapter, we introduce a class of decision problems where, if we think of forgetting in a novel but intuitive way, we can transform the game into a game of perfect recall – thus resolving the modelling ambiguities. In Section 1 we introduce some of the problems of modelling games with forgetful players. In Section 2 we survey some of the relevant literature and spend some time looking at the *Absentminded Driver Problem* as well as several solutions which have been suggested to overcome the apparent paradox. In Section 3 we introduce a different way of thinking about modelling memory imperfections which may be appropriate in certain circumstances. In Section 4 we outline the model, first in discrete time to help build our intuition and then later we solve the model in continuous time. In Section 5 we undertake some comparative statics on some variables of interest and end with some concluding remarks in Section 6.

### 1.1 MEMORY AND IMPERFECT RECALL

When psychologists speak about memory, what they are typically referring to is our ability to store, retain and recall information. One can break the process up into the following three stages:

1. Encoding – The process of receiving, processing and combining of information.

---

<sup>20</sup>Volume 20, Issue 1, Pages 1-130 (July 1997).

2. Storage – The creation of a permanent record of the encoded information.
3. Retrieval – Recalling the stored information in response to some cue.

For economists' modelling purposes we have to 'operationalise' our definition of memory. Rubinstein (1998) does this well when he says that,

*'Memory is a special type of knowledge. It is what a decision maker knows at a certain date about what he knew at a previous date.'*

Clearly, attempting to model memory using the three stages, encoding, storage and retrieval is no small task, particularly as we may want to allow for errors in each of these. For example, an agent may encode a piece of information incorrectly; or once he stores it, it may change over time so that when he retrieves it, it is substantially different from the message that was originally encoded; or a piece of information may only be partially recalled. This is why the papers which attempt to model imperfect recall in games typically treat memory as a binary, that is, you either remember something or you do not. There is no intermediate case of partially remembering something or remembering something which did not happen. Nevertheless, once we have a satisfactory model of forgetting in a binary world, there is no reason why economists should not relax these assumptions and proceed to tackle these substantive issues.

Typically, economists have assumed that agents have 'perfect recall' – they do not forget what they once knew, including their own actions. That is, if a DM knows something at time  $t$  then he knows it in all  $t' > t$ . Formally, for any two nodes  $x'$  and  $x''$  in the same information set  $X$ , it must be that  $\exp(x') = \exp(x'')$ , where  $\exp(x)$  is the experience of the player when reaching node  $x$ . That is, the information sets that he has passed and the actions that he has taken. Clearly, people do forget things, some more than others. Von Neumann and Morgenstern (1944) first discussed the possibility that a decision maker in an extensive form game might have imperfect recall. They argued that it might be appropriate to model a group of individuals, who communicate with each other imperfectly, working in a team as one forgetful agent.

Nevertheless, this never really took off as a research program, mainly because game theorists began to look upon perfect recall as a part of rationality. Indeed Selten (1975) writes:

*“Since game theory is concerned with the behavior of absolutely rational decision makers whose capabilities of reasoning and memorizing are unlimited, a game, where the players are individuals rather than teams, must have perfect recall.”*

Furthermore, decision problems with perfect recall have certain attractive properties which no longer hold in the case of imperfect recall. In particular, for any individual decision problem  $G$ , let  $G'$  be the transformed game where each information-set in  $G$  is assigned a separate player; each player has the same preferences over outcomes as the player in  $G$ . Then it is well known that a play of  $G$  is optimal if and only if it is a subgame perfect equilibrium of  $G'$ . Thus, one can solve a decision problem of perfect recall by backward induction.

## 1.2 AN EXAMPLE

When agents forget during the course of play, we say that they have *imperfect recall* or *bounded recall*. Consider the following simple example with a single decision maker:

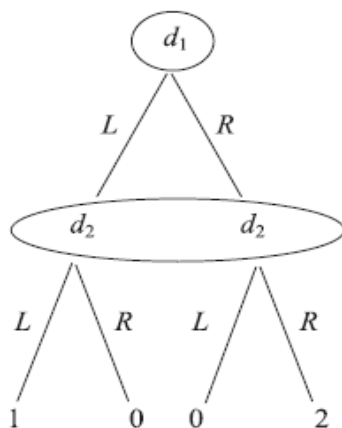

Figure 1: Rubinstein (1998)

Here, the agent forgets whether he played L or R at  $d_1$ . He cannot recall at  $d_2$  whether the history of the game has been  $\{L\}$  or  $\{R\}$ . If he had perfect recall at  $d_2$ , then clearly he would pick the history  $\{R,R\}$  which yields him the highest payoff of 2. Now, with imperfect recall, he may or may not be able to achieve the highest payoff, it depends on our modelling assumptions.

If we say that at the beginning of the game the player is able to submit a strategy, which specifies an action for each information set, to a third-party to be executed, then clearly, the decision maker will submit the strategy  $\{R,R\}$

and it will indeed be implemented. Another way of reaching the same conclusion would be to posit a pre-play planning stage where the decision maker is able to choose a strategy, call it  $S$ , which he is then able to recall at information set  $d_2$ . At  $d_2$ , he is able to infer that since he has been following the strategy  $S$ , the node he has reached in the information set must be consistent with his strategy; this effectively allows him to differentiate between the two nodes at  $d_2$ . Thus an optimal play would be to choose the strategy  $\{R,R\}$  in the pre-play planning stage and then play according to the strategy at both  $d_1$  and  $d_2$ , thus achieving his desired payoff.

Alternatively, we might consider the case where there is a pre-play planning stage but that the strategy chosen is forgotten once the decision maker reaches information set  $d_2$ . This is problematic, since he cannot tell at  $d_2$  which node he is at. Furthermore, it is not clear how he can form beliefs about which node he is at, since typically, beliefs are formed to be consistent with the strategy which is being played. How then to proceed? One could argue that the superior outcome of  $\{R,R\}$  is salient and so it would be natural for the decision maker to attempt to coordinate on it, but this is by no means clear. Similarly, if there is no planning stage and the player 'plays-as-he-goes' then it is not clear whether his two 'selves' will be able to coordinate and thus any of the four possible outcomes could result.

Attempting to model imperfect recall is important for at least two reasons. Firstly, while perfect recall may be a good assumption for simple games, for games with even more than a handful of actions it is likely that players will be forgetful. So, if we are really interested in modelling how agents might *actually* play a game rather than Selten's (1975) idealisation then we should not just restrict ourselves to games of perfect recall. Secondly, as von Neumann and Morgenstern (1944) allude to, imperfect recall can also be used to describe an organisation where different employees – whose incentives are assumed to be aligned – are asked to act at different times, however, they communicate with each other imperfectly about what has happened in the past.



## 2 LITERATURE

There exists a reasonable, but by no means large, literature on memory in economics, concentrated in game theory. For example, we know from Kuhn's (1953) Theorem that the equivalence of mixed strategies and behaviour strategies only holds in games of perfect recall. There is also some literature in repeated games where the implausibility of remembering arbitrarily long histories is particularly problematic. A number of papers have a similar flavour to Sabourian (1998) who analyses repeated games where players can only remember the previous  $N$ -periods; of particular interest is what happens to Folk Theorems in this case. Dow (1991) considers a simple search model with a consumer who has to optimally decide how to utilise his bounded memory and Mullainathan (2002) investigates the relationship between memory and rationality.

### 2.1 THE ABSENTMINDED DRIVER

By far the most well-known paper on imperfect recall is to be found in the *Games and Economic Behavior* (Issue 20, Vol. 1) special issue dedicated to the analysis of Imperfect Recall. Here, Piccione and Rubinstein (1997) (PR from now on) argue that modelling issues which are of little or no consequence in games of perfect recall, suddenly become substantive in games of imperfect recall. In making their point, the authors introduce the *paradox of the absent minded driver*. This simple game, involving only one player and one information set, clearly touched a nerve among decision theorists which explains the number of follow up papers which try to resolve the paradox. What becomes clear on reading these papers is that even eminent decision theorists disagree substantially on how one should model imperfect recall. This is problematic since there is no agreed upon solution concept for games with imperfect recall. To illustrate some of the issues, it is instructive to look at PR's absent minded driver example.

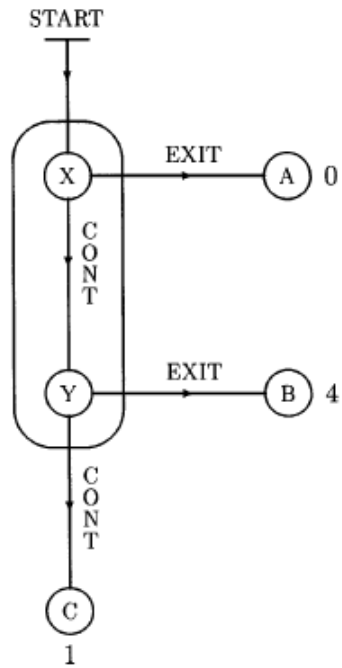

Figure 2: Aumann, Hart and Perry (1997)

Consider the following scenario: you are contemplating the drive home from work; to get home you need to take the motorway. If you take the first exit off the motorway then you enter a rough neighbourhood where there is a substantial risk that your car will be stolen; the second exit, is the one you want to take, it takes you home; if you miss the second exit you have to take a long route home. So far so good, with perfect recall this is a trivial decision problem. Now, however, suppose that you are ‘absentminded’ in that you cannot distinguish between the first and second exit. The

extensive form is shown in Figure 2.

If we consider only pure strategies it seems that it is impossible for the DM to get home. Either he plays EXIT, in which case he will exit at the first exit (yielding a payoff of 0), or he plays CONT, in which case he misses his turning (yielding a payoff of 1). At START it is reasonable to suppose that the DM will choose the ex-ante optimal strategy CONT. Notice however, that once he reaches the information set, he is able to form beliefs about which node he is at. The beliefs consistent with his strategy place equal probability of being at node X or Y. The expected payoff from EXIT is now 2. The DM wishes to change his strategy even though it seems that he has no new information and his preferences are unchanged. If he now reasons that he would have exited at X, consistent beliefs are now (1, 0) (i.e. that he is at node X for sure) so he should continue!

This seems strange, he knew that he would reach the information set for sure when he was contemplating his choice at work, yet once he reaches the information set he wishes to change his strategy. The paradox remains when we allow the DM to play a mixed strategy, in this case the ex-ante optimal strategy exits with probability 1/3. But the beliefs

consistent with that strategy mean that the strategy is no longer optimal once the information set is reached.

## 2.2 OVERCOMING THE PARADOX

A number of varied resolutions are posited to the absent-minded driver problem, I give a brief summary here to emphasise the diversity of opinion:

PR argue that when called upon to play you should consider that you are at one of the two nodes while your 'twin' is at the other. When considering a deviation from your strategy you should assume that your twin will continue to play the original strategy. In this formulation, a strategy which remains optimal when you reach the information set is called *modified multiseif consistent*. It turns out that the ex-ante optimal strategy is also modified multiseif consistent; indeed they show that modified multiseif consistency is a necessary condition for optimality.

Battigalli (1997) introduces a concept which he calls *constrained time consistency*, essentially what he is arguing is that, suppose you are following a strategy  $S$ , then if at some point you are considering whether to change your strategy to  $S'$ , you should reason that you can only signal to your future selves that you have changed strategy when your new strategy  $S'$  reaches an information set inconsistent with  $S$ , that is, is not reached with positive probability under  $S$ . Thus, when considering a deviation from  $S$ , you must restrict yourself to deviations which agree with  $S$  at information sets reached with positive probability under  $S$ . The strategy  $S'$  can however differ from  $S$  at information sets inconsistent with  $S$ . Any strategy which is robust to this kind of deviation is constrained time consistent. He shows that constrained time consistency is a necessary condition for optimality. My concern here is that (if indeed the only way to communicate with future selves is through strategy choice) whilst I agree that, if an information set is reached which is inconsistent with  $S$ , the self called upon to play at that information set can reason that that strategy being played is not  $S$ . It is by no means clear to me that he will be able to correctly guess

that  $S'$  is being played as opposed to any other strategy which is consistent with reaching the information set in which he is called upon to play.

Gilboa (1997) dislikes the whole concept of absentmindedness, that is, two histories lying in the same information set where one history is a sub-history of the other. He says that this ‘violates some of the basic...foundations of decision theory.’ He suggests that instead the decision maker should think of herself as ‘two identical agents’ called  $a$  and  $b$ . Nature moves first to determine, with equal probability, which one of the two is called upon to act at the first decision node. When called upon to act, neither knows whether he has been called to act first or second, only that he himself and not his twin is acting now. Gilboa argues that in this way the game can be transformed into a game of perfect recall but imperfect information:

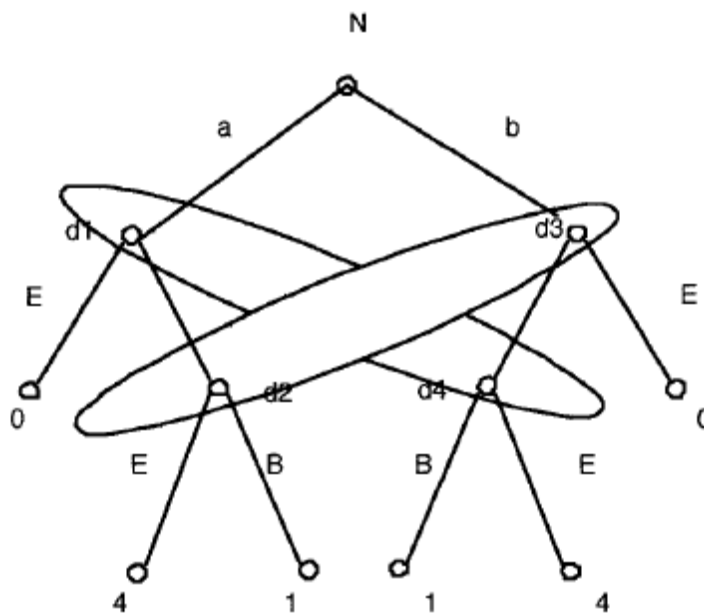

Figure 3: Gilboa (1997)

Now we are in familiar territory, games of imperfect information have agreed upon solution concepts. Indeed, if we find the symmetric equilibrium of this game, we find that it coincides with the

ex-ante optimal strategy of exiting with probability  $1/3$ .

Aumann, Hart and Perry (AHP) (1997) argue forcefully that there is no paradox here and that any apparent paradox is the result of questionable analysis. They divide the problem into a *planning stage* and an *action stage* and argue that a decision must be made at each node.

When at a node, the decision maker can only determine his action there and not at the other node. If nodes are in the same information set, whatever reasoning obtains at one node must obtain at the other and the decision maker is aware of this. They argue that if analysed ‘correctly’ the only ‘action optimal’ choice is also ‘planning optimal’ and that in general, action optimality is a necessary condition for planning optimality. Lipman (1997) makes the case that AHP’s analysis is essentially the same as Gilboa’s.

Grove and Halpern (1997) make the point that the expected value of a game with absentmindedness is not well defined. They propose that the value of a game should be calculated using only the ‘upper frontier’ of the information sets. That is, using only the nodes which have no predecessor node in the same information set, and then weighting these by the probability of being at that node given that you are in the upper frontier of the information set containing that node. Doing this, they contend, solves the apparent paradox. Furthermore they stress the importance of the difference between ‘being at’ and ‘reaching’ a node at some point during play in games with absentmindedness.

Halpern (1997) is the only paper in the collection which attempts to provide a new modelling framework which moves beyond the extensive form representation. Briefly, he does this by defining an *environment state*, which describes the state of the external world at that point in time; this is analogous to the history of the game in extensive form. In addition to this, each agent has his own state which captures all the information that the agent has at that point in time. Together, the environment state and the agents’ states make up the global state. Agents do not have strategies but protocols, which map from their local state to a probability distribution over actions. Thus in this framework, when modelling, one must be specific about exactly what the agent knows in any particular state, not just what he knows about the history of the game. Indeed, he shows that if the decision maker is able to reconsider arbitrarily often and is able to recall his most recent strategy choice then he can come arbitrarily close to simulating perfect recall in any game. For example, in the absentminded driver game consider that the DM makes the following

plan with himself: 'I will start with strategy S, when reaching the information set, if my current strategy is S, then I know that I am at the first intersection, so I will change my strategy to S' which specifies that I should continue. When at the information set for a second time I will recall that my current strategy is S' which allows me to infer that I am at the second intersection, thus I will change my strategy again to S'' which specifies that I should exit.' Such a plan will allow the DM to simulate perfect recall and exit at his preferred time.

These differences of opinion and modelling ambiguities stem from the observation that imperfect recall as represented by an extensive form game only tells us that some aspect of the history of the game so far has been forgotten – it tells us nothing about other issues which are now relevant to the decision problem, such as whether the strategy is recalled; if and when the decision maker is able to reconsider his strategy; if he does choose to change his strategy does he recall this?; when at a node and considering a deviation can he change his action only at that node or at other nodes? Indeed, one of the reasons why extensive form representation of games of perfect recall has been so successful is that these modelling issues are immaterial in games of perfect recall. I take the view that Halpern is correct that, in general, for games of imperfect recall the extensive form formulation is simply not appropriate in many cases since it leaves so many material modelling issues ambiguous.

### **3 A NEW PERSPECTIVE ON FORGETTING**

What I want to argue however is that there is a class of decision problems, where - if we think of forgetting in a novel but intuitive way - we can transform a game which has a forgetful agent into a game which looks like it has perfect recall – this resolves the modelling ambiguities since there are agreed upon solutions concepts for solving games of perfect recall. The key to our argument is that when people forget to do things, they typically forget about its existence rather than being confused about the current date or

the history of the game so far. Indeed, there is a nice literature in economics which has developed on ‘rational inattention’ which argues that humans have limited attention and must decide how to optimally allocate their attention between competing requests for their consideration.<sup>21</sup> The link with what is being presented here is that, if a decision maker decides to allocate very little attention to remembering some task that he would like to complete, that makes it very likely that most of the time he will not be aware of the task. That is, he will have forgotten the very existence of the task, which for most tasks would preclude him from completing it during those periods of forgetfulness. In our model, we do not analyse how the decision maker will allocate attention across a number of competing areas, rather we consider that, given he is not giving full attention to this task, he will be forgetful, and he cannot act at those times in which he is forgetful.

Although I do not dispute that in the absentminded driver problem one could be absentminded about whether one was at the first or second intersection when deciding whether to turn off a motorway – I think this is a peculiar way of looking at forgetting something in many ways. Think about the last time that you missed your turning off the motorway, or even forgot to do anything, is it not the case that it is usually because at that point in time, when you planned to act, you forget about the very *existence* of the task rather than being confused about whether the task should be completed today or tomorrow? Similarly with everyday tasks, such as attending a meeting, buying the correct groceries from a supermarket or remembering to call your mother, when you forget to do them it is not typically because you are unsure about where you are in the game tree but rather because, at that point in time you forget that you are supposed to do the task at all. Furthermore, the prevalence of the explanation when asked why someone did not do something on time that ‘it [the task] completely slipped my mind’ supports this view.

When we teach game theory to students we often stress that a strategy is a complete contingent plan which specifies an action at each information set assigned to the player (including information sets which could not possibly be reached by the strategy). Consider then the

---

<sup>21</sup> See for example Sims (2003, 2006).

following model of memory: you submit your strategy to a central planner to be implemented, but forgetting means that the actions prescribed at some information sets are deleted. This is a potentially serious problem as it is not clear how the planner is to choose an action for you – an action has to be chosen, the game requires it, but which? Clearly, it would be nice if there was a ‘default’ action which could be played in such circumstances. In terms of remembering to take the correct turning off a motorway, forgetting is arguably more naturally interpreted as forgetting that you were supposed to take a turning at all. Notice that, at an intersection, if you remember that you might need to take a turn, you are effectively given a choice as to whether to turn off the road or to continue. While if you forget that you might need to take a turning, you have no choice, you continue down the motorway, it is almost as if you were called upon to act, but since you did not respond in time, a ‘default’ action (of continuing down the motorway) was played on your behalf.

## 4 THE MODEL

We look at a dynamic model which exploits a nice feature of many decision problems where forgetfulness is an issue: that there may exist natural default actions which can be played when the agent forgets.

A discrete-time **deadline problem** is an individual decision problem where some task can be completed before some deadline; in doing the task, the DM incurs an immediate cost,  $c$ , but receives a reward,  $v$ , at the time of the deadline regardless of when he completes the task. If the deadline passes without the DM completing the task, he gets nothing. Time is discrete  $t = 0, 1, \dots, T$ . In each time period the agent must choose either to delay (D) or act (A). The DM has standard discounted utility preferences and discounts the future with factor  $\delta \in (0, 1)$ .

**Assumption 1:**  $v > c$ , i.e. the task is worthwhile.



Clearly, given the task is worthwhile; one should wait until the final period to do the task. This discounts the cost the DM has to pay without affecting the timing of the reward. His optimal strategy should be  $\{D, D, \dots, D, A\}$ . We can see this clearly in the extensive form:

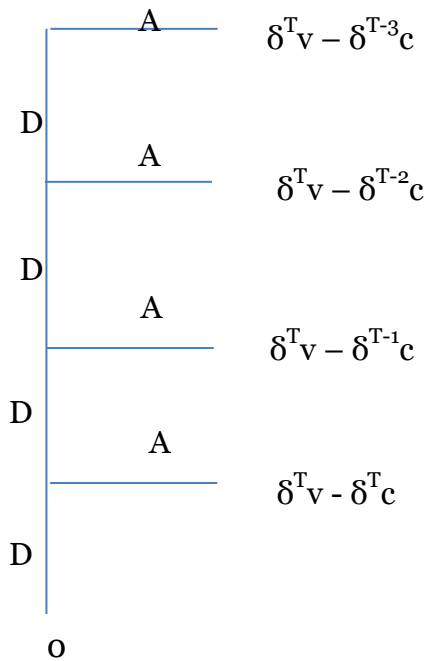

Figure 4: Extensive Form

So far, memory has not been an issue. We now complicate the model so that in any given time period, the DM may forget that this opportunity exists, in which case he cannot possibly complete the task, instead he moves to the next time period by default. Notice that forgetting is equivalent to intentionally delaying. It may now be optimal to complete the task early in order to avoid missing the deadline. If we rephrase the problem as follows it has a certain resonance with PR's absentminded driver problem:

Suppose you are attempting to drive home, there are multiple turnings however the correct turning is the final turning. If you take the wrong turning you have to take a slightly longer route, although the further away the turning you take is from the final turning, the longer the detour. If however, you miss your turning, you enter a motorway which does not have an exit for many miles.

Now, again, this problem is trivial if the agent has a perfect memory but what about if he is absentminded? Not in the sense of PR's absentmindedness (that he cannot tell which intersection he is at) but instead that sometimes when called upon at an intersection, there is no response – he simply forgets that he might have to turn off the road at all. To distinguish this from PR's notion of absentmindedness, I call this *carelessness*.

#### 4.1 THE DISCRETE TIME PROBLEM WITH CARELESSNESS

Here, we consider the simple case where the DM remembers in each period with independent and identically distributed probability  $p$ . We assume that whenever the DM is called upon to act, he maximises his discounted expected utility.

##### *Timing*

In each time period  $t$ , so long as the DM has not already completed the task, the timing is as follows:

1. Nature moves first and decides whether the DM remembers or not in that time period. With probability  $p$ , the DM remembers, and with probability  $1 - p$  he forgets.
2. If he remembers, he has the option to 'Act' and complete the task (in which case his payoff is  $\delta^t v - \delta^t c$  and the game ends) or he can 'Delay', which causes him to wait and move to the next time period. If he forgets, he moves to the next time period without any choice.

The extensive form for each time period  $t$  is then:

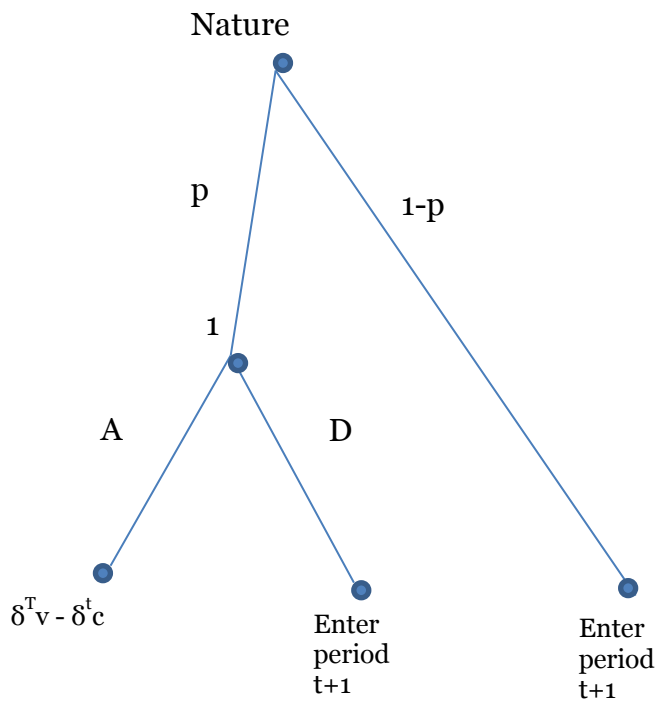

Figure 5: Time period  $t$  extensive form.

Notice that, the extensive form of the game has a perfect recall structure (not only that, it is also a game of perfect information). This becomes clear, when we look at the extensive form of a sub-game where there are exactly two period remaining until the deadline and the DM has not yet completed the task:<sup>22</sup>

<sup>22</sup> Since there will typically be many possible histories of the game before this point, there will be many such subgames. This is just one of those subgames, but as we will argue later, what is optimal in the subgame will be independent of the history of the game.

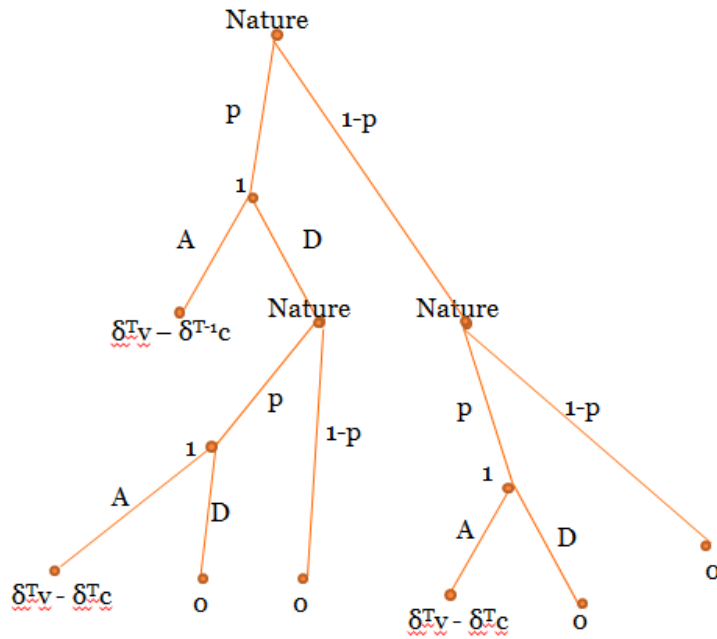

Figure 6: Last two-period Extensive Form

The game in Figure 6 begins at time  $T - 1$ , Nature decides if the DM remembers in this time period or not. With probability  $p$  the DM remembers, with probability  $1 - p$  he forgets. If he remembers, he has to choose between ‘Act’ and ‘Delay’. If he acts, the game ends and his payoff is realised, if he delays, he enters period  $T$ . If he forgets, he enters period  $T$  by default. Notice that the two period- $T$  subgames (one that results from forgetting in period  $T - 1$  and the other that results from the DM remembering in period  $T - 1$  and actively deciding to wait) are identical. This leads to an important observation: the DM’s optimal future strategy – conditional on reaching period  $t$  without already completing the task – is independent of the history of the game before period  $t$ . This observation simplifies the DM’s strategy substantially since it means that we only need to specify a single action for each time period; that action being chosen in the state of the world that the DM remembers and is called upon to act in that time period. For example, a strategy for the game in Figure 6 would specify an action in each of the three information sets that the DM may be called upon to act. However, since the subgames which follow time period  $T$  are identical, what is optimal in one must be optimal in the other. Thus the optimal strategy need only specify (i) an action to be played if the player remembers in period  $T - 1$ , and (ii) an action to be played if the player remembers in period  $T$ . In general then, a

strategy need only specify an action for each time period given that the DM remembers in that time period and has reached it without already completing the task. The other useful thing that we learn is that the expected value of the (not yet completed) task to the DM only depends upon the current time period; it does not depend on how the DM reached the current time period. With this in mind we can define the following value function:

**Defintion 1:**  $V_t =$  Expected utility at start of period  $t$  (calculated from a  $t = 0$  perspective).

Note that this is an optimal value function, that is, it is defined assuming that the DM will act optimally to maximise his expected utility whenever he is called upon to act in future. For example it must be that  $V_T = p(\delta^T v - \delta^T c)$ , the term in the brackets is the realised payoff if the task is completed in the final period, the DM is only able to achieve this if he remembers, which occurs with probability  $p$ . The expression for  $V_{T-1}$  is slightly more involved since it involves a decision, but inspecting Figure 5, it is not hard to see that it must satisfy

$$V_{T-1} = (1 - p)V_T + p \cdot \max\{\delta^T v - \delta^{T-1}c, V_T\}$$

Exploiting the recursive structure, gives us that, for any  $t \in \{0, 1, \dots, T\}$ :

$$V_t = (1 - p)V_{t+1} + p \cdot \max\{\delta^T v - \delta^t c, V_{t+1}\}$$

That is, the value of the game at the start of period  $t$  – before nature has decided whether the decision maker will remember or not in that time period – is the probability weighted average of the next period value (which the DM gets for sure if he forgets) and the larger of, the next period value and the realised payoff if the task is completed and the game ends (this is the relevant calculation if the DM remembers). This recursion allows us to show our first result which tells us that once the DM decides that if he remembers, he will Act, he will never revert to the Delay strategy at some later date.

**Result 1:** *If the decision maker wants to do the task if he remembers at time  $s$ , then he will want to do the task if he remembers at all times  $t > s$ .*

**Proof:**  $V_t = (1 - p)V_{t+1} + p\max\{\delta^T v - \delta^t c, V_{t+1}\}$  (Bellman)

$$\begin{aligned}
&\Rightarrow V_t - V_{t+1} = -pV_{t+1} + p\max\{\delta^T v - \delta^t c, V_{t+1}\} \\
&\Rightarrow V_t - V_{t+1} = p[\max\{\delta^T v - \delta^t c, V_{t+1}\} - V_{t+1}] \\
&\Rightarrow V_t - V_{t+1} = p\max\{\delta^T v - \delta^t c - V_{t+1}, 0\} \tag{1}
\end{aligned}$$

The right hand side of this expression must be non-negative.

$$\begin{aligned}
&\therefore V_t - V_{t+1} \geq 0 \\
&\Rightarrow V_t \geq V_{t+1} \tag{2}
\end{aligned}$$

That is, it must be that  $V_t$  cannot increase over time. Since  $\delta^T v - \delta^t c$  is strictly increasing in  $t$  and  $V_t$  is non-increasing in  $t$ , if there is ever a time  $s$  where  $\delta^T v - \delta^s c > V_{s+1}$  then it must be the case that  $\delta^T v - \delta^t c > V_{t+1}$  for all  $t > s$ . QED.

This makes sense, imagine that the deadline is very far away so that  $T$  is large and the current time,  $t$ , is small, then it will not typically make sense for the DM to complete the task since the reward from completing the task will be heavily discounted relative to the cost of completion. Furthermore, since there is such a large amount of time between now and the deadline the DM reasons that it is very likely that he will remember again before the deadline passes. As time passes, the reward is not discounted as heavily compared to the discounting of the cost and also delaying becomes more risky since the probability of not remembering before the deadline increases. Thus, the passing of time makes it unambiguously more attractive to complete the task, which is why the DM will never switch from wanting to complete the task to not wanting to complete the task, if he remembers.

We know from (2) that the value of the game  $V_t$  will never increase over time. Inspecting (1) we are able to say more about the behaviour of  $V_t$ . In particular, in those time periods where the DM does not wish to complete the task if he remembers, it must be that

$$V_t - V_{t+1} = 0$$

That is, the value function is constant. While in those time periods where the DM does wish to complete the task if he remembers, we have that

$$V_t - V_{t+1} = p(\delta^T v - \delta^t c - V_{t+1}) > 0$$

That is, the value function must be strictly decreasing. Again, both of these observations make sense. Recall that the value function always calculates the expected discounted utility from a fixed ( $t = 0$ ) perspective, so it must be that it judges being at any two time-periods where the DM will not wish to complete the task as equally good. This is because there is no chance that the DM will complete the task in the time that will elapse between the two time periods. That is, if we call  $\tau$ , the first time that the DM wishes to complete the task if he remembers, then it is inevitable that at least an amount of time  $\tau$  will elapse after the start of the game before the DM completes the task (if he completes it at all). There is however a subtle point here, from the perspective of the decision maker himself, his expected discounted utility from the task is increasing as he moves closer to time  $\tau$ . This is because his perspective moves through time with him. That is, if we asked the decision maker himself at time  $t = 0$  how much he would need to be paid right now in order for him to forego the task and then asked him the same question at time  $t = \tau$ , he would need to be offered more money at the later date. This is obvious if one considers a simple problem where a DM will be given a prize of £100 at some particular date, clearly as he approaches the date, the prize looks more attractive to him from his current perspective. The reason why we always evaluate payoffs from a fixed perspective is that this makes welfare comparisons between two different outcomes meaningful.<sup>23</sup>

As for the intuition for why the value function falls after time  $\tau$ , consider that  $\tau$  has been chosen to optimally trade off the benefits of waiting to complete the task with the risk of passing the deadline without completing the task. Thus, any time which elapses after time  $\tau$  without the DM completing the task can only reduce his expected discounted utility. Suppose it did not, and that

---

<sup>23</sup> The other way of considering the problem would be to define  $V_t$  as the value of the game from a time  $t$  perspective. This would also be fine but the recursive problem would have to be rewritten as  $V_t = (1 - p)\delta V_{t+1} + p \cdot \max\{\delta^{T-t} v - c, \delta V_{t+1}\}$ .

there exists a  $t > \tau$  such that  $V_t > V_\tau$ , then it would not be optimal for the DM to complete the task if he remembers at time  $\tau$ , rather he should wait until time  $t$  before considering completing the task, but this contradicts that  $\tau$  is the first time that he would like to complete the task if he remembers. Furthermore, we know from Result 1, that if it is optimal for the DM to Act at time  $\tau$ , it is optimal for him to act in all future time periods. This must mean that the value function monotonically decreases after time  $\tau$ . That is, the passage of time without the DM completing the task means that he has missed opportunities to complete the task when it would have been optimal for him to complete the task. There is again a subtle point here, while it is true that the DM's expected utility decreases after time  $\tau$  as he gets close to the deadline, this does not mean that his *realised* payoff will be less for sure. What I mean is, the best outcome for the DM *ex-post* will always be forgetting until the final time period and then remembering at the exact time of the deadline, this discounts the cost the most heavily without affecting the reward. However, typically, at time  $t = 0$  the decision maker would not be happy to hear that will reach the deadline without completing the task, since this means that he must remember at time  $T$ , in order to receive a non-zero payoff. The figure below shows how the value function for a deadline problem might look.

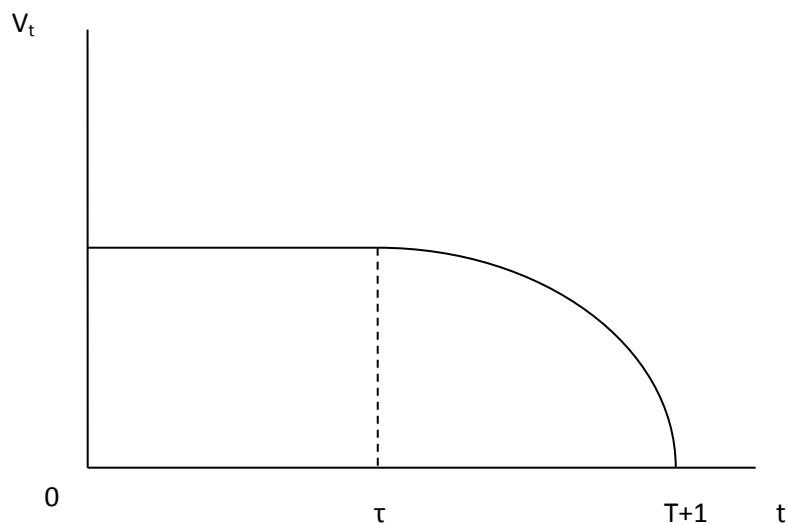

Figure 7: How the Value Function  $V_t$  varies over time.



We can see  $V_t$  is constant in the region  $[0, \tau]$ , since, during this time, even if the DM does remember, he prefers to delay. After  $\tau$ ,  $V_t$  falls, since, as we get closer to  $T$  without yet completing the task, the greater the possibility that the deadline passes without completion. At  $T+1$  the deadline has passed and the task is now worthless.

## 4.2 THE CONTINUOUS TIME PROBLEM

While the discrete time case is good for building our intuition it leads to some results which can seem quite peculiar e.g. that the probability of completing the task can fall as one's memory technology improves.<sup>24</sup> Solving the model in continuous time will also give us sharper predictions.<sup>25</sup> The continuous time analogue of the DM remembering in each period with i.i.d. probability  $p$  is a Poisson process where as a default the DM is in a state of forgetfulness but at certain instants 'memory events' occur according to a Poisson process with arrival rate  $\lambda$ . We define a 'memory event' to be an event which triggers the decision maker's memory, if and only if this happens is he able to choose whether to complete the task or to delay. If he completes the task, he realises his payoff; if he delays, he will again immediately enter a state of forgetfulness, only remembering again if and when a new memory event occurs.

A **continuous-time deadline problem with forgetting** is an individual decision problem where some task can be completed before some deadline; in doing the task the DM incurs an immediate cost,  $c$ , but receives a reward,  $v$ , at the time of the deadline regardless of when he completes the task. If the deadline passes without the DM completing the task, he gets nothing. Time is continuous in the interval  $[0, T]$ . The DM can only complete the task at those instants where he remembers, when he remembers he must choose either to delay (D) or act (A). When he forgets, he cannot complete the task and so it is as though the action D is played by default. The DM has standard discounted utility preferences and discounts the future at the rate  $\rho > 0$ .

In the result below we solve analytically for many of the variables of interest which we introduced in the previous subsection.

---

<sup>24</sup> This can happen if a small increase in the probability of remembering causes  $\tau$  to increase by one.

<sup>25</sup> What I mean is, in discrete time, two decision makers with different memory technologies can have observationally equivalent behaviour, so long as they have the same value for  $\tau$ .

**Result 2:** For an interior solution:

(i) The value of the game at time  $t$ ,  $V_t$ , can be solved for analytically and in particular:

$$V_t = \begin{cases} ve^{-\rho T} - \frac{\lambda}{\rho+\lambda} ce^{-\rho t} - e^{-(\rho+\lambda)T} \left[ \frac{\rho v + \lambda(v-c)}{\rho+\lambda} \right] e^{\lambda t}, & \text{for } t > \tau \\ ve^{-\rho T} - \frac{\lambda}{\rho+\lambda} ce^{-\rho \tau} - e^{-(\rho+\lambda)T} \left[ \frac{\rho v + \lambda(v-c)}{\rho+\lambda} \right] e^{\lambda \tau}, & \text{for } t \leq \tau \end{cases}$$

Where  $\tau$  is the first time that the decision maker wants to do the task if he remembers.

(ii) The amount of time within which the DM is willing to do the task if he remembers is:

$$T - \tau = \ln \left[ \frac{\rho v + \lambda(v-c)}{\rho c} \right]^{\frac{1}{\rho+\lambda}}$$

(iii) The probability that the DM completes the task at all,  $\varphi$ , satisfies:

$$\varphi = 1 - \left[ \frac{\rho v + \lambda(v-c)}{\rho c} \right]^{-\frac{\lambda}{\rho+\lambda}}.$$

**Proof:**

(i) We can write the following Bellman equation, which says that when calculating the DM's expected utility at time  $t$  we should consider that he forgets in a small interval of time  $\Delta$  with probability  $(1 - \Delta\lambda)$ . In which case, he does not get the opportunity to make a choice and gets a payoff  $V_{t+\Delta}$ . Similarly, with probability  $\Delta\lambda$ , a memory event does occur and he is able to choose between completing the task (yielding  $ve^{-\rho T} - ce^{-\rho t}$ ) and delaying (yielding  $V_{t+\Delta}$ ).

$$V_t = (1 - \Delta\lambda)V_{t+\Delta} + \Delta\lambda \max\{V_{t+\Delta}, ve^{-\rho T} - ce^{-\rho t}\}$$

In the state of the world where a memory event occurs, either, the decision maker does not want to do the task, in which case the value function is constant:  $V_t = V_{t+\Delta}$ , or, he would prefer to act, in which case:

$$\begin{aligned} V_t &= (1 - \Delta\lambda)V_{t+\Delta} + \Delta\lambda(ve^{-\rho T} - ce^{-\rho t}) \\ \Rightarrow \frac{V_t - V_{t+\Delta}}{\Delta} &= -\lambda V_{t+\Delta} + \lambda(ve^{-\rho T} - ce^{-\rho t}) \end{aligned}$$

Letting  $\Delta \rightarrow 0$ :

$$\frac{dV_t}{dt} = \lambda V_t - \lambda(v e^{-\rho T} - c e^{-\rho t}).$$

To solve this differential equation notice that

$$\begin{aligned} \frac{d[V_t e^{-\lambda t}]}{dt} &= \frac{dV_t}{dt} e^{-\lambda t} - \lambda e^{-\lambda t} V_t \\ &= e^{-\lambda t} \left[ \frac{dV_t}{dt} - \lambda V_t \right] \\ &= e^{-\lambda t} [-\lambda(v e^{-\rho T} - c e^{-\rho t})] \end{aligned}$$

Integrating both sides gives us that

$$\begin{aligned} V_t e^{-\lambda t} &= \int e^{-\lambda t} [-\lambda(v e^{-\rho T} - c e^{-\rho t})] dt \\ \Rightarrow V_t &= -\lambda e^{\lambda t} \int e^{-\lambda t} (v e^{-\rho T} - c e^{-\rho t}) dt \\ \Rightarrow V_t &= v e^{-\rho T} - \frac{\lambda}{\rho + \lambda} c e^{-\rho t} + K e^{\lambda t}. \end{aligned}$$

Where  $K$  is some constant of integration. We can solve for  $K$  by using the boundary condition that at the time of the deadline the task is worthless,  $V_T = 0$ . Which gives us that

$$K = -e^{-(\rho + \lambda)T} \left[ \frac{\rho v + \lambda(v - c)}{\rho + \lambda} \right].$$

Thus we have that

$$V_t = v e^{-\rho T} - \frac{\lambda}{\rho + \lambda} c e^{-\rho t} - e^{-(\rho + \lambda)T} \left[ \frac{\rho v + \lambda(v - c)}{\rho + \lambda} \right] e^{\lambda t}, \quad \text{for } t > \tau$$

Recalling that prior to  $\tau$ , the value function is constant. This gives us the result.

(ii) It must be the case that the decision maker is indifferent between doing the task and waiting when  $V_\tau = v e^{-\rho T} - c e^{-\rho \tau}$ . Solving explicitly for  $T - \tau$  we have:

$$\begin{aligned}
ve^{-\rho T} - \frac{\lambda}{\rho + \lambda} ce^{-\rho\tau} - e^{-(\rho+\lambda)T} \left[ \frac{\rho v + \lambda(v-c)}{\rho + \lambda} \right] e^{\lambda\tau} &= ve^{-\rho T} - ce^{-\rho\tau} \\
\Rightarrow \frac{\rho}{\rho + \lambda} ce^{-\rho\tau} &= e^{-(\rho+\lambda)T} \left[ \frac{\rho v + \lambda(v-c)}{\rho + \lambda} \right] e^{\lambda\tau} \\
\Rightarrow \rho c &= e^{-(\rho+\lambda)(T-\tau)} [\rho v + \lambda(v-c)] \\
\Rightarrow \ln \left[ \frac{\rho c}{\rho v + \lambda(v-c)} \right] &= -(\rho + \lambda)(T - \tau) \\
\Rightarrow T - \tau &= \ln \left[ \frac{\rho v + \lambda(v-c)}{\rho c} \right]^{\frac{1}{\rho + \lambda}}
\end{aligned}$$

(iii) In order for the DM to complete the task, at least one memory event must occur during the period of time between  $\tau$  and  $T$ . We know from the properties of the Poisson process that:

$$\Pr[k \text{ memory events occurring in period of time } t] = \frac{e^{-\lambda t} (\lambda t)^k}{k!}.$$

It follows that:

$$\begin{aligned}
\varphi &= \Pr[\text{at least one memory event occurring in period of time } T - \tau] \\
&= 1 - e^{-\lambda(T-\tau)} = 1 - \left[ \frac{\rho v + \lambda(v-c)}{\rho c} \right]^{-\frac{\lambda}{\rho + \lambda}} \quad \blacksquare
\end{aligned}$$

Inspecting the result in part (i) above, we see that the value function for  $t > \tau$  takes the form:

$$V_t = ve^{-\rho T} - \frac{\lambda}{\rho + \lambda} ce^{-\rho t} - e^{-(\rho+\lambda)T} \left[ \frac{\rho v + \lambda(v-c)}{\rho + \lambda} \right] e^{\lambda t}$$

The first term is just the utility the DM receives from the discounted reward, notice that this term is not the expected discounted reward; rather it is the reward for sure. This is potentially surprising since the DM does not receive the reward for sure; he only receives it if he remembers after time  $\tau$ . The second term is the reduction in utility from paying the discounted cost today (for sure) multiplied by a fraction which is increasing in memory quality,  $\lambda$  and decreasing in the discount rate. The third term can be thought of as an adjustment term which

takes into account the fact that both the reward and the cost may never be realised and that there is uncertainty about when (if at all) the cost will be incurred.

Inspecting parts (ii) and (iii) of the result we see that the interval of time in which the DM will complete the task and the probability that the task will be completed at all, is some function of the discount rate,  $\rho$ , the arrival rate of memory events,  $\lambda$ , the value of the reward,  $v$ , and the cost of completing the task,  $c$ . These are the ‘natural’ parameters of the model and it would be worrying if the optimal decision rule did not depend on them. We also note that given our assumptions that the task is worthwhile, the expressions derived in parts (ii) and (iii) give us sensible values. That is, it is straightforward to see that  $T - \tau$  must be positive, as well as that the probability that the DM will complete the task will be some number between zero and one. To check that  $T - \tau \geq 0$ , notice that

$$\begin{aligned}
 T - \tau &\geq 0 \\
 \Leftrightarrow \ln \left[ \frac{\rho v + \lambda(v - c)}{\rho c} \right]^{\frac{1}{\rho + \lambda}} &\geq 0 \\
 \Leftrightarrow \left[ \frac{\rho v + \lambda(v - c)}{\rho c} \right]^{\frac{1}{\rho + \lambda}} &\geq 1 \\
 \Leftrightarrow \rho v + \lambda(v - c) &\geq \rho c \\
 \Leftrightarrow (\rho + \lambda)(v - c) &\geq 0
 \end{aligned}$$

This final inequality must hold since both expressions in brackets are non-negative. To check that  $\varphi \in [0,1]$ , notice that this is equivalent to requiring that  $\left[ \frac{\rho v + \lambda(v - c)}{\rho c} \right]^{-\frac{\lambda}{\rho + \lambda}} \in [0,1]$ . This expression must be positive since both the top and bottom of the fraction are positive. As for being less than one, we have

$$\left[ \frac{\rho v + \lambda(v - c)}{\rho c} \right]^{-\frac{\lambda}{\rho + \lambda}} \leq 1$$

$$\Leftrightarrow \left[ \frac{\rho c}{\rho v + \lambda(v - c)} \right]^{\frac{\lambda}{\rho + \lambda}} \leq 1$$

$$\Leftrightarrow \rho c \leq \rho v + \lambda(v - c)$$

$$\Leftrightarrow (\rho + \lambda)(v - c) \geq 0$$

Which we have already argued must be true in our problem.

## 5 COMPARATIVE STATICS

In this section we look at the comparative statics when the parameters of the model vary. We begin with a result which tells us how the length of the ‘action region’,  $T - \tau$ , varies with the parameters.

**Result 3:** *In an interior solution, the length of time in which the DM will do the task  $T - \tau$  is (i) increasing in the reward from completing the task,  $v$ ; (ii) decreasing in the immediate cost of completing the task,  $c$ ; (iii) decreasing in the DM’s discount rate,  $\rho$ .*

**Proof:**

$$(i) \quad \frac{\partial[T - \tau]}{\partial v} = \frac{1}{\rho v + \lambda(v - c)} > 0$$

$$(ii) \quad \frac{\partial[T - \tau]}{\partial c} = -\frac{1}{c} \cdot \frac{v}{\rho v + \lambda(v - c)} < 0$$

$$(iii) \quad \frac{\partial[T - \tau]}{\partial \rho} = -\frac{\ln\left[\frac{\rho v + \lambda(v - c)}{\rho c}\right]}{(\rho + \lambda)^2} - \frac{\lambda(v - c)}{\rho(\rho + \lambda)[\rho v + \lambda(v - c)]} < 0. \text{ QED}$$

The intuition behind these results is clear, as the reward,  $v$ , from completing the task increases; the decision maker is willing to undertake the task earlier. This is because now, since the stakes are higher, missing the deadline means missing out on a more substantial reward. A similar argument can be applied to why the DM wishes to wait longer when the cost,  $c$ , increases: now, when he recalls, doing the task seems less attractive because of the larger cost which would be paid immediately. As for the discount rate, as  $\rho$  increases, he prefers to delay further. This is because discounting heavily means that if he does the task early, by the time he receives the

reward, it is heavily discounted relative to the immediate cost that he had to pay at the time of completion. Thus, high discounting has a similar effect to increasing the cost of completing the task or decreasing the reward from completion. Indeed, in the limit, as he discounts so heavily that he stops caring about the future altogether ( $\rho \rightarrow \infty$ ); he prefers to wait until the very moment of the deadline before considering completing the task. Next, considering what happens when the DM's memory quality,  $\lambda$ , improves. Our intuition tells us that this does not change the payoff from doing the task now but does increase the payoff to delaying, since now it is more likely that the DM will remember again before the deadline, thus he should be willing to delay even further as his memory improves. We are unable to prove this result formally, so state it here as a conjecture.<sup>26</sup>

**Conjecture 1:** *In an interior solution, the length of time in which the DM will do the task  $T - \tau$  is decreasing in the DM's memory quality (or arrival rate of memory events),  $\lambda$ .*

What we can show formally is that, in the limit, as his memory become perfect ( $\lambda \rightarrow \infty$ ); he prefers to wait until the very moment of the deadline. That is,

$$\lim_{\lambda \rightarrow \infty} T - \tau = \lim_{\lambda \rightarrow \infty} \frac{1}{\rho + \lambda} \ln \left[ \frac{\rho v + \lambda(v - c)}{\rho c} \right].$$

Using L'Hopital's Rule:

$$\lim_{\lambda \rightarrow \infty} T - \tau = \lim_{\lambda \rightarrow \infty} \frac{\rho c}{\rho v + \lambda(v - c)} (v - c) = 0$$

We know this must be true, since there is no reason a DM who always remembered would choose to do the task early. This is a good consistency check for the model. While it is true that it seems that good memory quality,  $\lambda$ , and high discounting,  $\rho$ , look like they have the same impact on behaviour, this is not quite correct. What is true is that they mean that the DM will optimally play a strategy where he waits until he is close to the deadline, but because the reason for doing so is different in each case, the outcomes will be very different. When  $\lambda \rightarrow \infty$ , the DM

---

<sup>26</sup> The relevant derivative for this problem is  $\frac{\partial [T - \tau]}{\partial \lambda} = \frac{(v - c)(\rho + \lambda) - [\rho v + \lambda(v - c)] \ln \left[ \frac{\rho v + \lambda(v - c)}{\rho c} \right]}{(\rho + \lambda)^2 [\rho v + \lambda(v - c)]}$ .

knows that he can wait until the deadline and still complete the task for sure; whereas when  $\rho \rightarrow \infty$ , the DM received a negative payoff if he does the task before the deadline, and unless  $\lambda \rightarrow \infty$  at the same time, he will never complete the task. The next result considers the impact of varying the parameters on the value of the game to the DM.

**Result 4:** The *value function*  $V_t$  is increasing in: (i)  $v$ . And decreasing in: (ii)  $c$ .

**Proof:**

$$(i) \quad \frac{\partial V_t}{\partial v} = \frac{e^{\lambda T} - e^{\lambda t}}{e^{(\rho + \lambda)T}} > 0$$

$$(ii) \quad \frac{\partial V_t}{\partial c} = -\frac{\lambda}{\rho + \lambda} e^{-\rho t} < 0. \quad QED$$

This is straightforward, *ceteris paribus*, the DM would prefer a game with a larger reward and dislike a game with a large cost. Thinking about the other parameters, our intuition tells us that having a better memory is likely to be desirable for the DM. Remembering more often must dominate remembering less often since when the DM remembers and is called upon to act, he always has the option of waiting, which causes him to forget again. Equally, a large discount rate is likely to make the game less attractive since any realised reward will be discounted more heavily and also because we know from Result 3 that it shrinks the action region and makes it less likely that the task will be completed. As for increasing the time from the start of the game until the deadline,  $T$ , this has two possible effects on  $V_t$ , (i) a ‘discounting effect’ due to the reward being pushed further into the future and (ii) a ‘time effect’ due to the DM now having more time in which to complete the task. What is clear is that if  $t < \tau$ , the time effect is of no benefit to the DM since he does not want to complete the task in the extra time that he has gained. Thus, there is only a discounting effect. As for  $t > \tau$ , both effects will feature since the reward will be pushed forward but equally the DM will gain valuable time in which to act. Thus  $V_t$  will fall in response to an increase in  $T$  for  $t < \tau$  and the effect will be ambiguous for  $t > \tau$ .



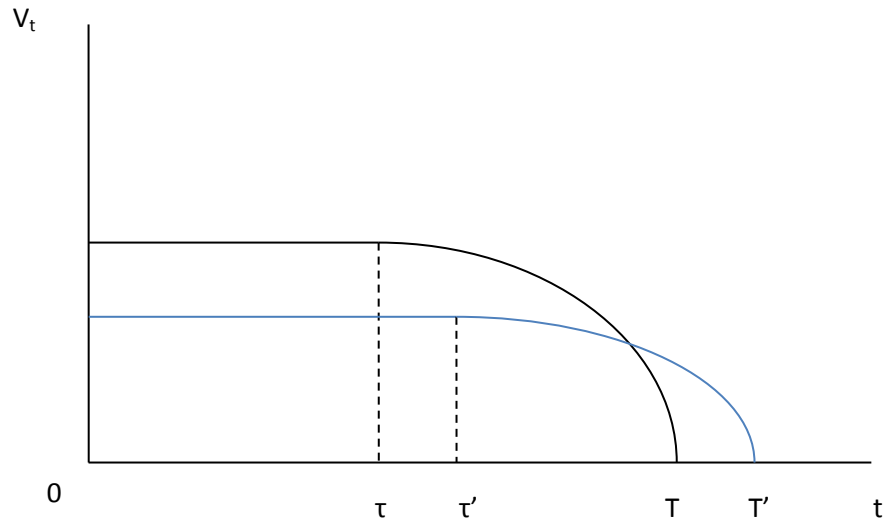

**Figure 8: The impact on  $V_t$  of an increase in  $T$ .**

Figure 8 shows an increase in  $T$  from  $T$  to  $T'$ . The dark line represents the value function initially and the blue line represents the value function after the change. Notice that the length of the action region is unchanged so that  $T - \tau = T' - \tau'$ , where  $\tau'$  is the first time the DM wishes to do the task if he remembers when the time to the deadline is  $T'$ . The intuition is that since the reward has been further discounted by  $T - T'$  time periods, in order to make the DM indifferent between acting and delaying, the cost must also be discounted by the same amount of time. One can also see this by inspecting the expression in Result 2 for  $T - \tau$ , notice that it is not a function of  $T$ .

Notice also that for  $t < \tau$ , there is an unambiguous decrease in  $V$ . This is a level effect due to the discounting effect only. As for  $t > \tau$ , now in addition there is a time effect, we see that for  $t$  close to  $\tau$ , the discounting effect dominates the time effect. That is, the extra time available to complete the task is not sufficient to compensate for the loss of the additional discounting. As  $t$  increases, at some point the value functions cross and the time effect dominates the discounting effect. It is easy to see why if we consider the DM being very close to the deadline in the original problem. Here, the task is almost worthless to the DM, so moving it further into the future has a limited cost in terms of discounting, however the additional time is very valuable since it means that, instead of completing the task with probability close to zero, he is able to

complete the task with some non-trivial positive probability. We are unable to prove these results formally, so state it here as a conjecture.

**Conjecture 2:** *Value function is increasing in: (i)  $\lambda$ . And decreasing in: (ii)  $\rho$ , (iii)  $T$  when  $T > \tau$ . And ambiguous in  $T$  when  $T < \tau$ .*

The next result looks at how likely the DM is to complete the task at all as the parameters are varied.

**Result 5:** *The probability that the DM completes the task at all, is increasing in (i)  $\lambda$ , (ii)  $v$  and decreasing in (iii)  $\rho$ , (iv)  $c$ .*

**Proof:** We know that  $\Pr [\text{DM completes the task at all}] = 1 - \left[ \frac{\rho v + \lambda(v-c)}{\rho c} \right]^{\frac{\lambda}{\rho + \lambda}}$ .

Let  $\gamma = \left[ \frac{\rho v + \lambda(v-c)}{\rho c} \right]^{\frac{\lambda}{\rho + \lambda}}$ . Then it can be easily shown that:

$$(i) \quad \frac{\partial \gamma}{\partial \lambda} = -\frac{\gamma}{\rho + \lambda} \left[ \frac{\rho}{\rho + \lambda} \ln \left[ \frac{\rho v + \lambda(v-c)}{\rho c} \right] + \frac{\lambda(v-c)}{\rho v + \lambda(v-c)} \right] < 0$$

$$(ii) \quad \frac{\partial \gamma}{\partial v} = -\frac{\gamma \lambda}{\rho v + \lambda(v-c)} < 0$$

$$(iii) \quad \frac{\partial \gamma}{\partial \rho} = \gamma \left[ \frac{\lambda}{(\rho + \lambda)^2} \ln \left[ \frac{\rho v + \lambda(v-c)}{\rho c} \right] + \frac{\lambda^2(v-c)}{\rho(\rho + \lambda)[\rho v + \lambda(v-c)]} \right] > 0$$

$$(iv) \quad \frac{\partial \gamma}{\partial c} = \frac{\gamma \lambda v}{[\rho v + \lambda(v-c)]c} > 0$$

Inspecting results (ii-iv), they confirm our intuition in the following sense: in order to complete a task it is necessary and sufficient for at least one memory event to occur in the action region. The probability of at least one memory event occurring in a period of time depends on two things; firstly, it depends on the arrival rate of memory events,  $\lambda$ , and secondly, the size (in terms of length of time) of the action region,  $T - \tau$ . Given that  $\lambda$  is fixed for these cases, what we are interested in is what happens to the action region: when the action region shrinks, the less likely the DM is to complete the task; while when the action region increases in size, the more likely the DM is to complete the task. This is indeed what we find.

This leaves case (i), which is potentially ambiguous since, as we vary  $\lambda$ , we expect both the arrival rate and the length of the action region to change. Increasing  $\lambda$ , by definition increases  $\lambda$ , but it also causes the action region to shrink as the DM takes into account the now increased probability of remembering again if he delays. Thus, if the action regions shrinks by enough, one could imagine a situation where increasing  $\lambda$  could possibly reduce the probability of completing the task. What our result tells us is that this is never the case; increasing  $\lambda$  always increases the probability of completing the task.<sup>27</sup>

## 6 CONCLUDING REMARKS

What I have tried to argue in this chapter is that, while it is legitimate to attempt to model forgetting using the apparatus of extensive form games which do not respect perfect recall; this can lead to substantial modelling difficulties stemming from the fact that modelling issues which are of little significance in games of perfect recall, suddenly become substantive in games of imperfect recall. It may be the case that for certain kinds of memory imperfections, a different, but intuitive, way of thinking about memory will be more fruitful. In particular, when modelling a forgetful decision maker attempting to complete some task I have shown that if one thinks about forgetting in terms of forgetting the very existence of the task instead of forgetting the history of the game, one can transform a game which involves a forgetful decision maker into a game which can be analysed using only the tools of games of perfect recall. Thus, in order to model forgetful decision makers it is not necessary to relax the requirement that the game satisfies perfect recall – forgetting can be embedded into the game itself.

---

<sup>27</sup> While this result holds in the continuous time case, in the discrete time case it is possible for the probability of completing a task to fall as one's memory improves. This is because for some parameter values a very small increase in  $\lambda$  can cause the number of periods in which the DM is willing to complete the task to fall discretely by one.

# CHAPTER 5: IMPERFECT RECALL AND TASK COMPLETION II

## 1 INTRODUCTION

In this chapter we extend the model presented in Chapter 4 in a number of ways. In Section 2 we allow for the DM to be naïve about the extent of his memory imperfections. We consider the impact of naivety on behaviour and welfare. In Section 3 we introduce a simple model of the DM having multiple tasks to complete, both under certainty (he is sure how many tasks he has to complete) and uncertainty (he is unsure how many tasks he has to complete but is able to learn about the state of the world he is in from informative signals). In Section 4 we analyse the link between forgetfulness and self-control problems, we show that an agent with self-control problems may in certain cases be better off having a bad memory. In Section 5 we look at some simple applications and consider whether a firm can offer different contracts to discriminate between different types of consumer with varying degrees of memory and sophistication.

### 1.1 LITERATURE

There is a burgeoning literature which deals with the interaction between boundedly rational agents and firms. DellaVigna and Malmendier (2004) and Eliaz and Spiegler (2006) are two papers which explore the interaction between a profit-maximising firm and dynamically inconsistent consumers. Typically, firms may want to offer a menu of contracts as a screening device which allows it to differentiate between sophisticated and naïve agents. This will often allow the firm to do better than a single contract. Indeed, DellaVigna and Malmendier (2004) argue that one can see this kind of behaviour at gyms which offer membership (a prepayment for, say, one year's free admission) or non-membership (where you pay per use). They find that many customers opt for the membership option, but then go on to visit the gym so little that it would have been cheaper to pay per visit. The intuition being that, visiting the gym is immediately costly but

reaps benefits in the future so a naïve time inconsistent consumer might think that he will regularly visit the gym (and thus that he should buy a membership) but when it actually comes to following through on his plan he is unable to. Esteban and Miyagawa (2006) consider the impact of consumers with self-control problems on market competition; they find that self-control problems can weaken price competition.

## 2 SOPHISTICATION AND NAIVETY

So far, our forgetful agent has predicted correctly the extent of his memory imperfections and responded optimally. One could say that although he has memory imperfections he is *sophisticated*, in that he knows he has memory imperfections and furthermore, he knows how he should change his behaviour to maximise his expected payoff. There is another possibility however, that he could be *naïve* about his forgetfulness and – in the extreme – consider that he has no memory imperfections, and thereby attempt to behave as though he has a perfect memory. This would lead to the DM playing an extremely suboptimal strategy when faced with a worthwhile deadline problem: he would wait until the last possible opportunity to do the task, completing it, if and only if he remembers at that time. In a discrete-time world this would mean that he would only complete the task with probability  $p$ , however, things are even worse in a continuous time world. In this case, no matter when he remembers the task, he always prefers to delay, even if he is arbitrarily close to the deadline! Thus, in a continuous time deadline problem a completely naïve DM will never complete the task.

One could also imagine a situation where the DM is partially naïve, that is, he is aware that he has an imperfect memory but thinks that his memory is better than it actually is. In this case, while the actual arrival rate of memory events might be  $\lambda$ , the DM would believe the arrival rate to be  $\lambda' \in (\lambda, \infty)$ . This would mean that typically the DM would still be willing to do the task before the deadline, but there would now be a period of time where he should optimally do the task if he remembers, but due to his partial naivety, he instead delays. Our first result is very much analogous to Chapter 4, Result 2:

**Result 1:** For an interior solution:

- (i) The value of the game at time  $t$ ,  $V_t$ , for a partially naïve DM who has memory quality  $\lambda$ , but believes he has memory quality  $\lambda'$  can be solved for analytically and in particular:

$$V_t = \begin{cases} ve^{-\rho T} - \frac{\lambda c}{\rho + \lambda} e^{-\rho t} + e^{-(\rho + \lambda)T} \left[ \frac{\lambda c}{\rho + \lambda} - v \right] e^{\lambda t}, & \text{for } t > \hat{t} \\ ve^{-\rho T} - \frac{\lambda c}{\rho + \lambda} e^{-\rho \hat{t}} + e^{-(\rho + \lambda)T} \left[ \frac{\lambda c}{\rho + \lambda} - v \right] e^{\lambda \hat{t}}, & \text{for } t \leq \hat{t} \end{cases}$$

Where  $\hat{t}$  = the switching time of a sophisticated DM with memory quality  $\lambda'$ .

- (ii) The amount of time within which the DM is willing to do the task of he remembers is:

$$T - \hat{t} = \ln \left[ \frac{\rho v + \lambda'(v - c)}{\rho c} \right]^{\frac{1}{\rho + \lambda'}}$$

- (iii)  $Pr$  [DM completes the task at all] =  $1 - \left[ \frac{\rho v + \lambda'(v - c)}{\rho c} \right]^{-\frac{\lambda}{\rho + \lambda'}}$

**Proof:**

(i) If the DM believes that the arrival rate of memory events is  $\lambda'$ , then he will behave as though the arrival rate of memory events is  $\lambda'$ . That is, he will choose his switching time (the time where he switches from delaying if he remembers to acting if he remembers) to be the same as the switching time of a sophisticated DM who actually has memory quality  $\lambda'$ . Recalling that prior to the switching time, the value function is constant. This gives us the result.

(ii) It must be the case that the decision maker is indifferent between doing the task and waiting when  $V_{\hat{t}} = ve^{-\rho T} - ce^{-\rho \hat{t}}$ . Solving explicitly for  $T - \hat{t}$  gives:

$$T - \hat{t} = \ln \left[ \frac{\rho v + \lambda'(v - c)}{\rho c} \right]^{\frac{1}{\rho + \lambda'}}$$

(iii) In order for the DM to complete the task, at least one memory event must occur during the period of time between  $\hat{t}$  and  $T$ . We know from the properties of the Poisson process that:

$$Pr[k \text{ memory events occurring in period of time } t] = \frac{e^{-\lambda t} (\lambda t)^k}{k!}.$$

It follows that:

Pr[at least one memory event occurring in period of time  $T - \hat{t}$ ]

$$= 1 - e^{-\lambda(T-\hat{t})} = 1 - \left[ \frac{\rho v + \lambda'(v-c)}{\rho c} \right]^{-\frac{\lambda}{\rho + \lambda'}}$$

■

It is clear that the more naïve the DM is, the worse off he is, this is because, the more naïve he is, the further his behaviour is from optimal. This is further confirmed if we graph the evolution of the value function for different levels of naivety:

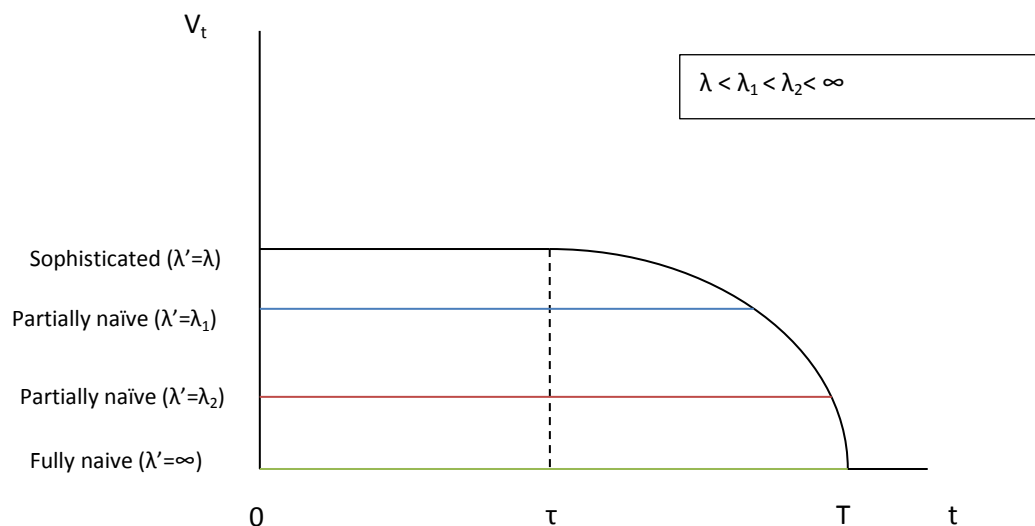

**Figure 1: How naivety reduces welfare.**

As one can see, as the DM becomes more naïve, the closer  $\hat{t}$  becomes to  $T$ , until in the limit when he is completely naïve, it is the case that  $\hat{t} = T$ . That is to say, he never completes the task when he is completely naïve, since, no matter how close he is to the deadline when he remembers, so long as he is not at the deadline (an event which happens with zero probability in continuous time) he will always delay. This is because he reasons that he will be able to complete the task exactly at the time of the deadline. Before  $\hat{t}$ , the value function is constant

due to the fact that he will never complete the task during this period, thus the DM is indifferent between being any two points in time in that period. After time  $\hat{t}$ , the value function follows the value function for the sophisticated type since, now, he is behaving optimally, that is, the DM wants to do the task and he optimally should want to do the task.

One can also imagine a situation where the DM is too cautious about his memory problems, that is, he thinks that his memory is worse than it actually is. Consider a DM who has memory quality  $\lambda$ , but believes that he has memory quality  $\lambda' < \lambda$ . Since he believes that he has memory quality  $\lambda'$ , he will behave as though he is a sophisticated DM with actual memory quality  $\lambda'$ . We know that as  $\lambda$  decreases, the DM wants to do the task earlier since now delaying is more risky. In the context of this DM, it will mean that there is now a period of time where he will complete the task if he remembers but it would have been better for him (in expected utility terms) to delay.

Diagrammatically:

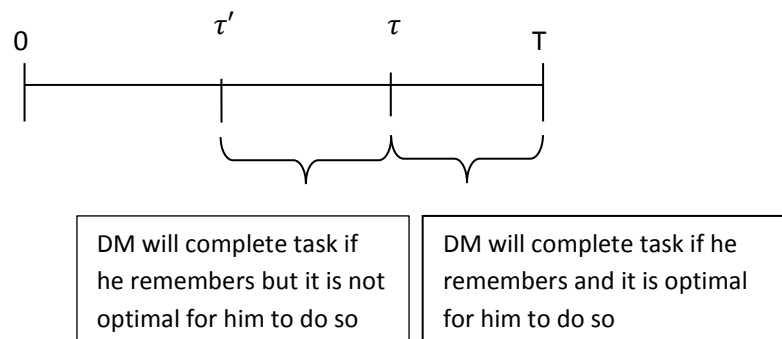

**Figure 2: When an overly cautious DM will complete the task if he remembers.**

Where  $\tau'$  is when a sophisticated DM with actual memory quality  $\lambda'$  would be indifferent between completing the task and delaying.

This kind of behaviour has an unusual effect on the shape of the value function. To see this consider what the value function would be like if the DM played the sub-optimal strategy: ‘act whenever you remember, regardless of whether it is optimal’. In this case, our earlier analysis in Chapter 4, Results 1 and 2 remains valid except that now there will be no ‘flat’ region of the value function where the DM prefers to delay. Thus the value function satisfies, for all  $t$ :



$$V_t = ve^{-\rho T} - \frac{\lambda c}{\rho + \lambda} e^{-\rho t} - e^{-(\rho + \lambda)T} \left[ \frac{\rho v + \lambda(v - c)}{\rho + \lambda} \right] e^{\lambda t}$$

We know what this looks like for  $t > \tau$ , it is the same as in the standard case. We also know that the effect of the DM playing a unique switching strategy – where before some time  $t'$  he delays if he remembers, and after that time he acts if he remembers – is that the value function will be flat before  $t'$ . Given this, we know that  $V_t$  must achieve a local maximum at  $t = \tau$  (one can verify this by setting  $V'(t) = 0$ ), if this were not the case, the optimal play of a deadline problem could be improved upon by being willing to act slightly before  $\tau$ . Indeed, we can show that  $V_t$  achieves a global maximum at  $t = \tau$ :

$$\begin{aligned} V(t) &= ve^{-\rho T} - \frac{\lambda c}{\rho + \lambda} e^{-\rho t} - e^{-(\rho + \lambda)T} \left[ \frac{\rho v + \lambda(v - c)}{\rho + \lambda} \right] e^{\lambda t} \\ \Rightarrow V'(t) &= \frac{\rho \lambda c}{\rho + \lambda} e^{-\rho t} - \lambda e^{-(\rho + \lambda)T} \left[ \frac{\rho v + \lambda(v - c)}{\rho + \lambda} \right] e^{\lambda t} \end{aligned}$$

Which we know is negative for  $t > \tau$  and positive for  $t < \tau$ , close to  $\tau$ . Thus it is sufficient to show that  $V''(t) < 0$  for all  $t$ , in order to prove that  $V$  achieves a global max at  $t = \tau$  and furthermore that  $V$  is globally strictly concave:

$$V''(t) = -\frac{\rho^2 \lambda c}{\rho + \lambda} e^{-\rho t} - \lambda^2 e^{-(\rho + \lambda)T} \left[ \frac{\rho v + \lambda(v - c)}{\rho + \lambda} \right] e^{\lambda t} < 0$$

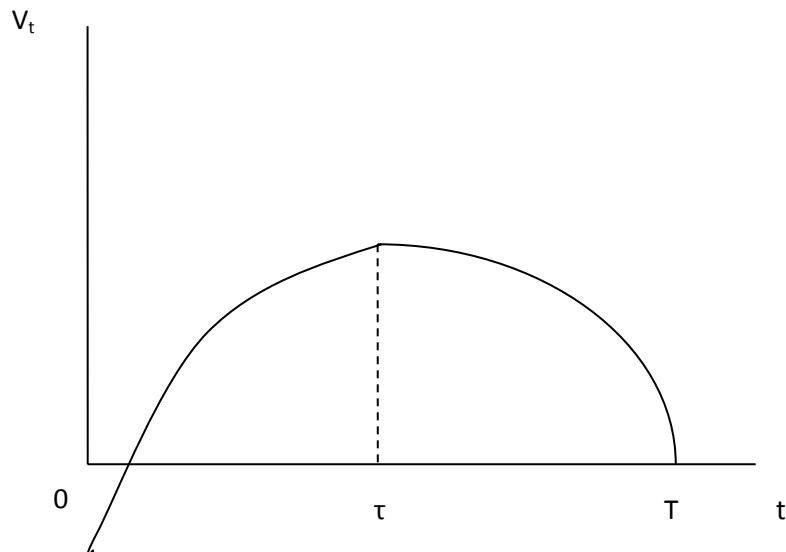

Figure 3: Hypothetical Value function when DM always acts

The value function is increasing initially; this is because before  $\tau$  the DM should optimally not complete the task. However, since he will if he remembers, it is ‘good news’ for him if time passes without a memory event occurring. Indeed, if he completes the task very early he risks receiving a negative payoff. This logic continues to be the case until time  $\tau$ . Coupling this knowledge of the behaviour of the value function with our understanding that the value function is constant during any time period where the DM prefers to delay tells us the following: for a DM whose memory is better than she believes it is, the value function will be constant in the interval  $[0, \tau']$ , increasing in the interval  $[\tau', \tau]$  and falling again after  $\tau$ :

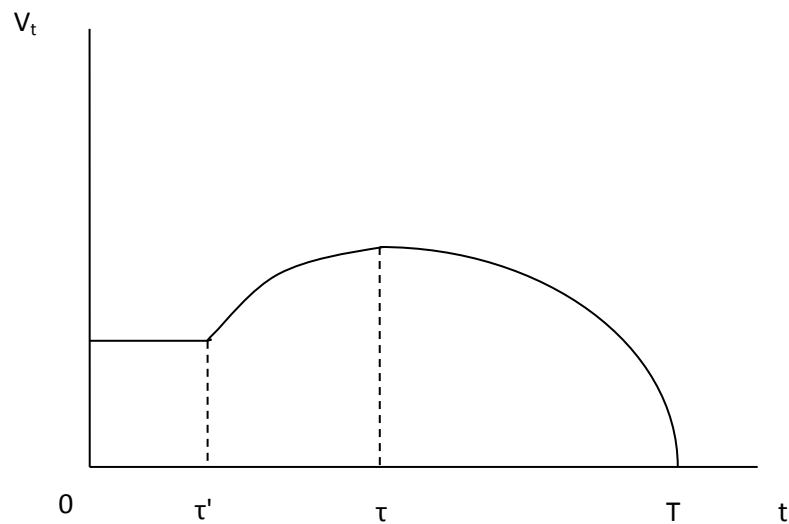

Figure 4: Value function for DM whose memory is better than she thinks it is.

The analysis above makes it clear why delaying before time  $\tau$ , and acting after time  $\tau$  dominates all other possible strategies that the DM could choose.

### 3 MULTIPLE TASKS

So far, the agent has only had one task to complete; here, we relax this so that multiple tasks run concurrently. This raises many questions. If the DM remembers one task, is he more or less likely to remember the others? Does attempting to remember multiple tasks reduce the probability of remembering any given one? Does this mean that there is an additional reason for

wanting to complete a task ‘early’ – namely, that it ‘unclogs’ one’s memory, leaving the DM able to focus on the remaining tasks? Furthermore, if he remembers multiple tasks in a single period can he complete more than one task? If he can only complete one task at a time, how does he choose which one to complete? As one can see there are many substantive modelling issues, so it is important to make clear what assumptions we are making.

### 3.1 MULTIPLE TASKS WITH CERTAINTY

For tractability we make some strong assumptions in the first instance: there are 2 tasks, both have same time-frame, cost, and payoff. When the DM has two tasks ‘stored’ in his memory, the Poisson arrival rate of remembering is  $\mu > \lambda$ . When one of the tasks is completed, the arrival rate switches back to  $\lambda$ . The DM only remembers one task at a time, and can only complete that particular task at the instant that he remembers. Since, whenever the DM is called upon to play, he remembers the history of the game; he knows exactly how many tasks he has outstanding. All of this is known by the DM.

Let us consider the case of two identical tasks in continuous time where the tasks maybe ‘memory complements’ or ‘memory substitutes’. If a Poisson process arrives at rate  $\lambda$  then it is well known that two identical independent Poisson processes arrive at rate  $2\lambda$ . In order to allow for the processes to be memory complements or substitutes (i.e. trying to remember two tasks makes it more/less likely to remember any given one), if the agent has two tasks remaining to complete, tasks will arrive at rate  $\mu$  (not necessarily equal to  $2\lambda$ ). Furthermore, when the agent remembers, since he remembers the history, he remembers how many tasks he has remaining, however, he can only complete the specific task he has remembered, since he only knows about the other task’s existence but not what it is exactly. Letting  $V_{2,t}$  be the value of the game to the DM (from a  $t = 0$  perspective) of reaching time  $t$  with two tasks still to complete; and letting  $\tau'$  be the time that the agent is indifferent between waiting and completing the first task, we have the following result.

**Result 2:** For  $t > \tau'$ , the value of the game to the DM (from a  $t = 0$  perspective) of reaching time  $t$  with two tasks still to complete satisfies

$$V_{2,t} = 2ve^{-\rho T} - \frac{\mu c}{\rho + \mu} e^{-\rho t} \left[ 1 + \frac{\lambda}{\rho + \lambda} \right] - \frac{\mu e^{-(\rho + \lambda)T + \lambda t}}{\lambda - \mu} \left[ \frac{\lambda c}{\rho + \lambda} - v \right] - \mu K e^{\mu t}.$$

Where  $K = e^{-(\rho + \mu)T} \left[ \frac{2v}{\mu} - \frac{c}{\rho + \mu} - \frac{\lambda c}{(\rho + \lambda)(\rho + \mu)} - \frac{\lambda c}{\lambda - \mu} - v \right]$ .

**Proof:** Considering a small interval of time  $\Delta$ , let:

$$\Delta\lambda = \text{Pr}[\text{remembering if 1 task stored in memory during this interval}]$$

$$\Delta\mu = \text{Pr}[\text{remembering if 2 tasks stored in memory during this interval}]$$

The value function for this problem is:

$$V_{2,t} = (1 - \Delta\mu)V_{2,t+\Delta} + \Delta\mu \cdot \max\{V_{2,t+\Delta}, ve^{-\rho T} - ce^{-\rho t} + V_{1,t+\Delta}\}$$

This is saying that when the DM has two tasks ‘stored’ in his memory then in a small period of time  $\Delta$ , he forgets with probability  $(1 - \Delta\mu)$ , in which case he gets  $V_{2,t+\Delta}$ , however with probability  $\Delta\mu$ , he remembers, in which case he can choose between delaying (yielding  $V_{2,t+\Delta}$ ) or completing a task, in which case he realises the payoff today from one of the tasks ( $ve^{-\rho T} - ce^{-\rho t}$ ), but also continues the game with one task ‘stored’ in his memory, this is valuable in expectation, we denote this by  $V_{1,t+\Delta}$ . Considering the times where the agent wishes to complete the first task:

$$V_{2,t} = (1 - \Delta\mu)V_{2,t+\Delta} + \Delta\mu \cdot (ve^{-\rho T} - ce^{-\rho t} + V_{1,t+\Delta})$$

$$\Rightarrow \frac{V_{2,t} - V_{2,t+\Delta}}{\Delta} = -\mu V_{2,t+\Delta} + \mu(ve^{-\rho T} - ce^{-\rho t} + V_{1,t+\Delta})$$

Letting  $\Delta \rightarrow 0$ :

$$-\frac{dV_{2,t}}{dt} = -\mu V_{2,t} + \mu(ve^{-\rho T} - ce^{-\rho t} + V_{1,t})$$

$$\Rightarrow \frac{d[V_{2,t}e^{-\mu t}]}{dt} = -\mu e^{-\mu t}(ve^{-\rho T} - ce^{-\rho t} + V_{1,t})$$

$$\Rightarrow V_{2,t} = -\mu e^{\mu t} \int e^{-\mu t} (ve^{-\rho T} - ce^{-\rho t} + V_{1,t}) dt$$

$$\Rightarrow V_{2,t} = -\mu e^{\mu t} \left[ -\frac{ve^{-\rho T}}{\mu} e^{-\mu t} + \frac{c}{\rho+\mu} e^{-(\rho+\mu)t} + \int V_{1,t} e^{-\mu t} dt \right] \quad (1)$$

We have previously solved for  $V_{1,t}$ , it is the single task value. Thus,

$$\int V_{1,t} e^{-\mu t} dt = -\frac{ve^{-\rho T}}{\mu} e^{-\mu t} + \frac{\lambda c}{(\rho+\lambda)(\rho+\mu)} e^{-(\rho+\mu)t} + \frac{e^{-(\rho+\mu)T}}{\lambda-\mu} \left[ \frac{\lambda c}{\rho+\lambda} - v \right] e^{-(\lambda-\mu)t} + K$$

Substituting this expression into (1) and using the boundary condition  $V_{2,T} = 0$  (i.e. if the deadline is reached with both tasks still incomplete, then they expire and are now worthless), we have:

$$V_{2,t} = 2ve^{-\rho T} - \frac{\mu c}{\rho+\mu} e^{-\rho t} \left[ 1 + \frac{\lambda}{\rho+\lambda} \right] - \frac{\mu e^{-(\rho+\lambda)T+\lambda t}}{\lambda-\mu} \left[ \frac{\lambda c}{\rho+\lambda} - v \right] - \mu K e^{\mu t}$$

$$\text{Where } K = e^{-(\rho+\mu)T} \left[ \frac{2v}{\mu} - \frac{c}{\rho+\mu} - \frac{\lambda c}{(\rho+\lambda)(\rho+\mu)} - \frac{\frac{\lambda c}{\rho+\lambda} - v}{\lambda-\mu} \right]$$

QED

To be clear, this is the expected value from a time zero perspective if the DM reaches time  $t$  without completing any task. If at some point the DM were to complete one of the tasks, he would realise his payoff for the task that he completed and would continue the game with a single task remaining, the expected value of which would be the single task value. As in the single task case,  $V_{2,t}$  will remain constant in those times where the DM does not wish to act and begins to fall after time  $\tau$ . We would like to be able to solve for time  $\tau$ , we cannot do this analytically but we can define it implicitly.

**Result 3:** *The first time the DM would like to complete one task if he has two tasks ‘stored’ in his memory,  $\tau$ , satisfies*

$$\left( 1 + \frac{\lambda}{\rho+\lambda} \right) \left( \frac{\rho}{\rho+\mu} \right) c - \left( \frac{\lambda c}{\rho+\lambda} - v \right) \left( \frac{\lambda}{\lambda-\mu} \right) e^{-(\rho+\lambda)(T-\tau)} - \mu K e^{(\rho+\mu)\tau} = 0 \quad (2)$$

Where  $K = e^{-(\rho+\mu)T} \left[ \frac{2v}{\mu} - \frac{c}{\rho+\mu} - \frac{\lambda c}{(\rho+\lambda)(\rho+\mu)} - \frac{\frac{\lambda c}{\rho+\lambda} - v}{\lambda - \mu} \right]$ .

**Proof:** At time  $\tau'$  the agent must be indifferent between waiting and completing the first task, this means that

$$V_{2,\tau'} = ve^{-\rho T} - ce^{-\rho\tau'} + V_{1,\tau'}$$

That is, the expected utility from waiting and continuing with two tasks remaining must equal the realised utility from completing one task now and continuing with one task remaining. We have

$$\begin{aligned} 2ve^{-\rho T} - \frac{\mu c}{\rho + \mu} e^{-\rho\tau'} \left[ 1 + \frac{\lambda}{\rho + \lambda} \right] - \frac{\mu e^{-(\rho+\lambda)T+\lambda\tau'}}{\lambda - \mu} \left[ \frac{\lambda c}{\rho + \lambda} - v \right] - \mu K e^{\mu\tau'} \\ = ve^{-\rho T} - ce^{-\rho\tau'} + ve^{-\rho T} - \frac{\lambda c}{\rho + \lambda} e^{-\rho\tau'} - e^{-(\rho+\lambda)T} \left[ \frac{\rho v + \lambda(v - c)}{\rho + \lambda} \right] e^{\lambda\tau'} \\ \Rightarrow -\frac{\mu c}{\rho + \mu} \left[ 1 + \frac{\lambda}{\rho + \lambda} \right] - \frac{\mu e^{-(\rho+\lambda)(T-\tau')}}{\lambda - \mu} \left[ \frac{\lambda c}{\rho + \lambda} - v \right] - \mu K e^{(\rho+\mu)\tau'} \\ = -c - \frac{\lambda c}{\rho + \lambda} - e^{-(\rho+\lambda)(T-\tau')} \left[ \frac{\rho v + \lambda(v - c)}{\rho + \lambda} \right] \end{aligned}$$

Taking everything to the LHS and collecting like terms allows us to define  $\tau'$  implicitly:

$$\left( 1 + \frac{\lambda}{\rho+\lambda} \right) \left( \frac{\rho}{\rho+\mu} \right) c - \left( \frac{\lambda c}{\rho+\lambda} - v \right) \left( \frac{\lambda}{\lambda-\mu} \right) e^{-(\rho+\lambda)(T-\tau')} - \mu K e^{(\rho+\mu)\tau'} = 0$$

QED

Now that we have implicitly defined  $\tau'$ , a natural next question is to ask how does  $\tau'$  compare with  $\tau$ . That is, how does  $\tau'$ , the first time that the DM wants to complete a task when he has two tasks 'stored' in his memory compare with  $\tau$ , the first time that the DM wants to complete a

task when he has one task ‘stored’ in his memory. The answer depends on whether the task are ‘memory complements’ or ‘memory substitutes’ as the result below confirms.

**Result 4:** *When,*

- (i)  $\mu = 2\lambda$ , that is, when the two tasks are neither complements nor substitutes, it is the case that  $\tau' = \tau$ .
- (ii)  $\mu > 2\lambda$ , that is, when the two tasks are complements, it is the case that  $\tau' > \tau$ .
- (iii)  $\mu < 2\lambda$ , that is, when the two tasks are substitutes, it is the case that  $\tau > \tau'$ .

Outline of **Proof:**

(i) First notice that the constant term,  $K$ , evaluated at  $\mu = 2\lambda$  is equal to zero. From (2), this gives us that:

$$\left(1 + \frac{\lambda}{\rho + \lambda}\right) \left(\frac{\rho}{\rho + \mu}\right) c - \left(\frac{\lambda c}{\rho + \lambda} - v\right) \left(\frac{\lambda}{\lambda - \mu}\right) e^{-(\rho + \lambda)(T - \tau')} = 0$$

Now, substituting  $\mu = 2\lambda$  gives us that:

$$\left(\frac{\rho}{\rho + \lambda}\right) c + \left(\frac{\lambda c}{\rho + \lambda} - v\right) e^{-(\rho + \lambda)(T - \tau')} = 0$$

Rearranging we have that:

$$T - \tau' = \ln \left[ \left( \left( \frac{\rho + \lambda}{\rho} \right) \frac{v}{c} - \frac{\lambda}{\rho} \right)^{\frac{1}{\rho + \lambda}} \right]$$

This is identical to  $T - \tau$  in the single task problem. Thus we now have our result that  $\tau' = \tau$ .

(ii) This we cannot prove analytically but consider that in this case the DM’s memory is better when he has two tasks ‘stored’ in his memory compared to in (i). We know that in case (i), when  $t = \tau$ , the DM is indifferent between doing the first of the two tasks and waiting. Since his memory is now improved, in that he is more likely to remember again if he delays compared to in (i), this strictly increases the expected payoff from delaying, so it is clear that at  $t = \tau$  he is no





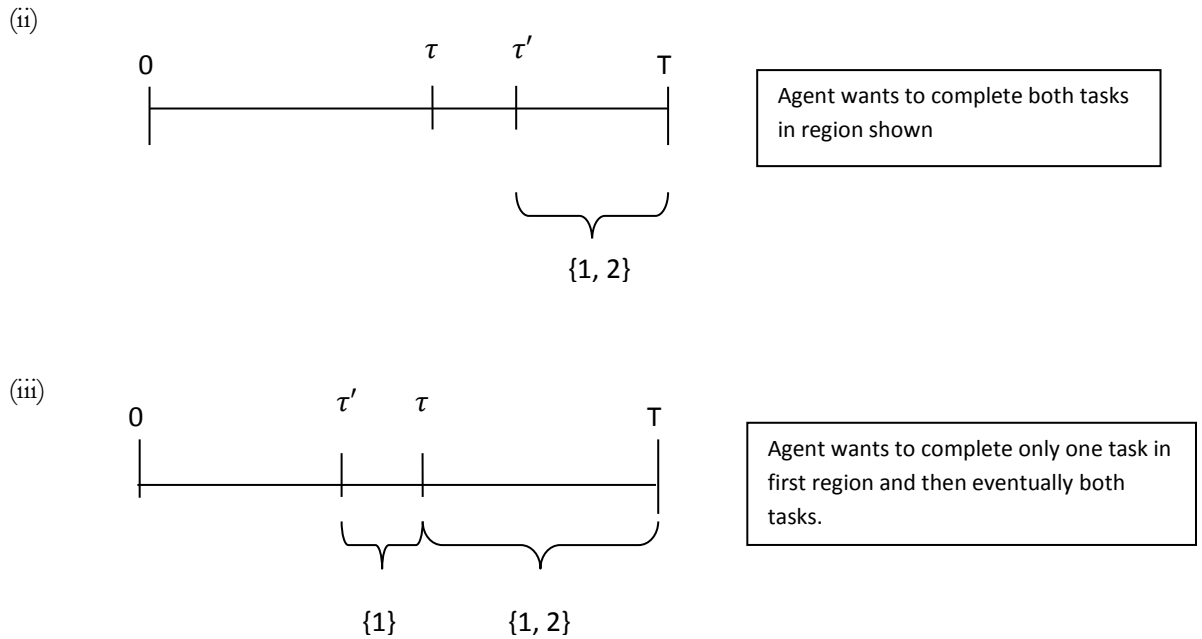

Figure 5: Task completion in different cases.

These diagrams are straightforward and intuitive. Notice that in case (ii), the case of memory complements. The fact that  $\tau' > \tau$ , means that it is impossible for a single task to be completed in the interval of time  $[\tau, \tau']$ . This is because the DM will not even have completed one of the two tasks by that time. That is,  $\tau'$  being larger than  $\tau$ , effectively pushes  $\tau$  up, so that it equals  $\tau'$ .

### 3.2 MULTIPLE TASKS WITH UNCERTAINTY

So far, the agent knows for sure that he has two tasks to potentially complete, but consider the following simple case where nature chooses how many tasks the agent is assigned. Nature chooses whether one or two tasks are assigned with probability  $\pi$ ,  $1 - \pi$  respectively. Both tasks 'look' identical but are different (this is an important assumption, it means that, when the player looks at the history of the game he cannot tell whether he has remembered task 1 or task 2, he only knows that he remembered a task). This is not observed by the agent who then faces the deadline problem. If he remembers, he observes the history of the game and he knows that he has at least one task to complete. Clearly, if he has already completed a task and remembers, he knows that he was assigned two tasks by nature (he cannot remember a task unless he still has a

task to complete). So the interesting case is where he has not yet completed a task and remembers; now he is not sure whether he has one task or two to complete.

Whether the two tasks are memory complements or substitutes is of consequence here. Inspecting Figure 5 we see that in case (i) it does not matter whether the agent knows he has one or two tasks remaining; he knows that if he is in the action region he wants to do the task. In case (ii) however between times  $\tau$  and  $\tau'$  if he has one task he would like to complete it, but not if he has two. Similarly in case (iii) between times  $\tau'$  and  $\tau$  he will want to do a task if he has two tasks but not one. In these uncertain cases it is important that the agent has beliefs about the state of the world he is in, that is, whether he has one task or two. Is there any way that the DM can learn about which state is more or less likely? We could write into the model that the DM observes some informative signal regarding the state at the start of the game. This will not be necessary when we notice that as time passes without a 'memory event' occurring, so long as  $\mu \neq \lambda$ , this in itself is informative about the state. Let  $k_t$  = the number of memory events which have occurred by time  $t$ . Now define

$$P_t(0) = \Pr[\text{Nature drew 1 task} | k_t = 0].$$

Then according to Bayes rule:

$$\begin{aligned} P_t(0) &= \frac{\Pr[k_t = 0 | 1 \text{ task}] \Pr[1 \text{ task}]}{\Pr[k_t = 0]} \\ &= \frac{\pi e^{-\lambda t}}{\pi e^{-\lambda t} + (1 - \pi) e^{-\mu t}} \end{aligned}$$

That is, conditional on nature drawing one task, the probability that no memory event occurs over time period  $t$  is given by  $e^{-\lambda t}$ . Similarly, conditional on nature drawing two tasks, the probability that no memory event occurs over time period  $t$  is given by  $e^{-\mu t}$ . Notice that  $P_t(0)$  increases over time, that is, as more time elapses without a memory event occurring, the more certain the DM is that there is only one task. Formally,

$$\frac{\partial P_t(0)}{\partial t} = \frac{(\pi e^{-\lambda t} + (1 - \pi)e^{-\mu t})(-\lambda \pi e^{-\lambda t}) + \pi e^{-\lambda t}(\lambda \pi e^{-\lambda t} + \mu(1 - \pi)e^{-\mu t})}{[\pi e^{-\lambda t} + (1 - \pi)e^{-\mu t}]^2}$$

The bottom of this fraction must be positive, thus the sign of the derivative depends on the sign of the top of the fraction. Simplifying,

$$(\pi e^{-\lambda t} + (1 - \pi)e^{-\mu t})(-\lambda \pi e^{-\lambda t}) + \pi e^{-\lambda t}(\lambda \pi e^{-\lambda t} + \mu(1 - \pi)e^{-\mu t}) \geq 0$$

$$\Leftrightarrow (\pi e^{-\lambda t} + (1 - \pi)e^{-\mu t})(-\lambda) + (\lambda \pi e^{-\lambda t} + \mu(1 - \pi)e^{-\mu t}) \geq 0$$

$$\Leftrightarrow \mu(1 - \pi)e^{-\mu t} - \lambda(1 - \pi)e^{-\mu t} \geq 0$$

$$\Leftrightarrow (1 - \pi)e^{-\mu t}(\mu - \lambda) \geq 0$$

This expression must be positive since it is the case that  $\mu > \lambda$ . This makes sense, no memory events occurring is informative, it increases the DM's belief that memory events are arriving at a slower rate  $\lambda < \mu$ . Equally, 'memory events' occurring are informative and cause beliefs to 'jump down'. This is because the DM now updates his belief in response to the memory event and reasons that he should put more weight on the true state being that there are two tasks. We can see this formally by letting  $P_t(k) = \Pr[1 \text{ task} | k \text{ memory events have occurred by time } t]$ . Then, again, according to Bayes Rule:

$$\begin{aligned} P_t(k) &= \frac{\Pr[k \text{ events} | 1 \text{ task}] \Pr[1 \text{ task}]}{\Pr[k \text{ events}]} \\ &= \frac{\lambda^k \pi e^{-\lambda t}}{\lambda^k \pi e^{-\lambda t} + \mu^k (1 - \pi) e^{-\mu t}} \end{aligned}$$

Taking the derivative with respect to k,

$$P'_t(k) = \frac{(\lambda^k \pi e^{-\lambda t} + \mu^k (1 - \pi) e^{-\mu t})(\lambda^k \ln \lambda \pi e^{-\lambda t}) - \lambda^k \pi e^{-\lambda t}(\lambda^k \ln \lambda \pi e^{-\lambda t} + \mu^k \ln \mu (1 - \pi) e^{-\mu t})}{[\lambda^k \pi e^{-\lambda t} + \mu^k (1 - \pi) e^{-\mu t}]^2}$$

The bottom of this fraction must be positive, thus the sign of the derivative depends on the sign of the top of the fraction. Simplifying,

$$(\lambda^k \pi e^{-\lambda t} + \mu^k (1 - \pi) e^{-\mu t})(\lambda^k \ln \lambda \pi e^{-\lambda t}) - \lambda^k \pi e^{-\lambda t}(\lambda^k \ln \lambda \pi e^{-\lambda t} + \mu^k \ln \mu (1 - \pi) e^{-\mu t}) \geq 0$$

$$\Leftrightarrow (\lambda^k \pi e^{-\lambda t} + \mu^k (1 - \pi) e^{-\mu t}) (\ln \lambda) - (\lambda^k \ln \lambda \pi e^{-\lambda t} + \mu^k \ln \mu (1 - \pi) e^{-\mu t}) \geq 0$$

$$\Leftrightarrow (\mu^k (1 - \pi) e^{-\mu t}) (\ln \lambda) - \mu^k \ln \mu (1 - \pi) e^{-\mu t} \geq 0$$

$$\Leftrightarrow (\mu^k (1 - \pi) e^{-\mu t}) (\ln \lambda - \ln \mu) \geq 0$$

This expression must be negative since  $\ln \mu > \ln \lambda$ . Notice that, while the elapse of time without a memory event occurring causes a smooth increase in  $P_t$ , a memory event causes a discrete jump downwards in  $P_t$ . This is because time passes continuously while a memory event occurring increases  $k$  by a discrete amount. We can attempt to solve this model, if the DM does the task at time  $t$ , then his expected payoff is:

$$P_t [v e^{-\rho T} - c e^{-\rho t}] + (1 - P_t) [v e^{-\rho T} - c e^{-\rho t} + V_{1,t}] = A_t$$

That is, with probability  $P_t$  (the  $k$  in brackets is omitted for expositional simplicity) he is in the one task state in which case he realises the payoff from completing that task and with probability  $1 - P_t$  he is in the two task state, in which case he realises the payoff from one of the tasks and then continues to play the game with only one task remaining. Notice that in the two task state, after completing the first task, the game collapses to the standard single task case, which he will be able to play optimally since if a memory event ever occurs again he will know that he has exactly one task remaining.

We can form a value function for this problem by again considering a very small interval of time  $\Delta$  and noticing that now, given his beliefs, the decision maker considers that the probability of a memory event occurring is  $P_t \Delta \lambda + (1 - P_t) \Delta \mu$ , that is, with probability  $P_t$  he is in the one task case, in which case memory events arrive at rate  $\lambda$ , otherwise they arrive at rate  $\mu$ . We are now able to form the value function:

$$\tilde{V}_t = [1 - \Delta(P_t \lambda + (1 - P_t) \mu)] \tilde{V}_{t+\Delta} + \Delta(P_t \lambda + (1 - P_t) \mu) \max\{\tilde{V}_{t+\Delta}, A_t\}$$

So, either it is the case that the DM does not want to complete the task, in which case the value function is constant, or he prefers to act, in which case, we can use the same method as we have previously and find that the value function satisfies:<sup>28</sup>

$$\tilde{V}_t = -e^{(P_t\lambda + (1-P_t)\mu)t} \int [P_t\lambda + (1-P_t)\mu] e^{-(P_t\lambda + (1-P_t)\mu)t} A_t dt$$

An analytical solution appears intractable. What we can say however is that, like in the earlier case, the DM is indifferent between acting and waiting when  $\tilde{V}_t = A_t$ . We can call this time  $\tilde{\tau}$ , furthermore we can argue that in an interior solution, it will be the case that  $\tilde{\tau} \in [\tau, \tau']$ . That is to say, when the DM does not know whether he has one or two tasks, he is indifferent between completing a task and delaying at a point in time which is some weighted average of the optimal switching times in the cases where the DM knows whether he has one or two tasks. This is true since it would never be optimal, in either the one task or two task states to complete a task before this interval. Equally, the DM would never want to delay until a point in time which would be past this interval in either the one or two task states, since this would be suboptimal for both states of the world. Diagrammatically:

- (i)  $\mu < 2\lambda$  (Memory substitutes)

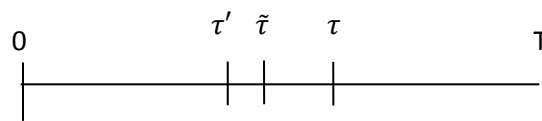

- (ii)  $\mu > 2\lambda$  (Memory complements)

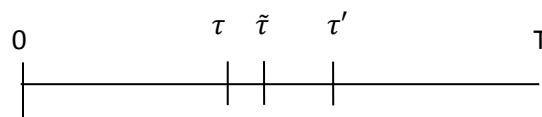

Figure 6: Task completion with memory complements and substitutes.

<sup>28</sup> i.e. by forming a differential equation.

This claim is not controversial; it is saying that when the DM is unsure about whether he has one or two tasks, he acts in a way which is some average of the way he would act if he knew he had one or two tasks for sure.

#### 4 MEMORY AND SELF-CONTROL

It is clear that when faced with a deadline problem, having memory imperfections has negative implications for welfare compared to the case where the DM has a perfect memory. Similarly, it is well known that time inconsistent preferences can mean that agents behave suboptimally. For example, we know that if agents have hyperbolic time preference and are even a little naïve (they are not completely aware of how their time-preference will evolve in the future), they can procrastinate forever [see O'Donoghue and Rabin (2001)]. One might expect a DM who is both time inconsistent and has memory imperfections to be doubly handicapped, and indeed it can be shown that this is often the case. What is more revealing however is that, in a restricted class of cases, having memory imperfections and time inconsistent preferences can be better than having time inconsistent preferences alone. This is because his awareness of his memory problems causes him to act when the alternative would have been to delay forever.

Consider an amended version of our model, that of a simple **delayed reward task**: if the DM completes the task at time  $t$ , he pays a cost,  $c$ , at that time, in return, he gets a reward,  $v$ , at time  $t+1$ . He discounts the current time-period with factor  $\beta$ , and all other time-periods with factor  $\delta$ . As is standard in these models, he is present biased and so  $\beta < \delta$ . Assume further that the DM is completely naïve and so believes that his preferences today will remain his preferences in the future.<sup>29</sup> Our somewhat counterintuitive result can now be stated.

---

<sup>29</sup> The result does not actually require the DM to be completely naïve, so long as he is not completely sophisticated there will still typically exist tasks which having a poor memory will help him to complete.

**Result 5:** *Having a bad memory can mean that a DM who is sophisticated about his memory imperfections but who is naïve about his self-control problems and would otherwise procrastinate, will now want to complete the delayed reward task.*

**Proof:** First, consider the case where the DM has no memory problems. From his current perspective, if he does the task now, he gets:  $\beta v - c$ . That is, he pays the cost now and gets the reward tomorrow, which is discounted by a factor  $\beta$ . If he delays, because of his naivety, he thinks that he will do the task in the next period (so long as  $\delta v - c > 0$ ). He thinks (incorrectly) that his payoff from delaying will be  $\beta\delta v - \beta c$  (from today's perspective). The DM will then procrastinate (forever) when his perceived payoff from delaying is greater than his payoff from acting now:  $\beta\delta v - \beta c > \beta v - c$ , or equivalently when

$$v < \frac{(1 - \beta)c}{\beta(1 - \delta)}$$

When  $v > \frac{(1-\beta)c}{\beta(1-\delta)}$ , he prefers to do it now rather than later even though he has self-control problems and is naïve. The intuition for this is that by delaying one period, the DM thinks that he is discounting his reward by a further factor of  $\delta$  but also that he is discounting his cost by a further factor of  $\beta$ . For large values of  $v$ , even the greater discounting of the cost is not sufficient incentive to delay the reward by a further time period. Figure 7 below shows how the outcome varies for different values of the reward relative to the cost.

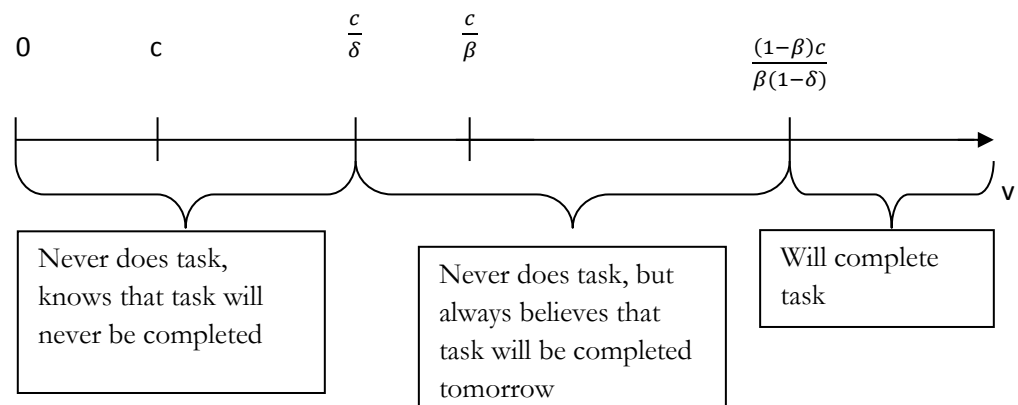

Figure 7: Task completion as  $v$  varies.

Now consider the case where the DM has a bad memory: in any given time period he forgets that the task exists with probability  $1 - p$ , in which case he misses the opportunity to complete the task and moves to the next period. When the DM remembers, if he completes the task, he gets a payoff of  $\beta v - c$  for sure. If he delays, he (thinks he) gets:  $E[u_{\text{DELAY}}] = p(\beta\delta v - \beta c) + (1 - p)p(\beta\delta^2 v - \beta\delta c) + (1 - p)^2 p(\beta\delta^3 v - \beta\delta^2 c) + \dots$

Summing this infinite series we have

$$E[u_{\text{DELAY}}] = \frac{p\beta(\delta v - c)}{1 - (1-p)\delta} = K(\delta v - c) \quad (3)$$

Now, he will want to act when  $\beta v - c \geq \frac{p\beta(\delta v - c)}{1 - (1-p)\delta}$ , or equivalently when

$$v \geq \frac{c(1 - K)}{\beta - \delta K}, \quad \text{where } K = \frac{p\beta}{1 - (1-p)\delta} \in (0, \beta)$$

Let  $X = \frac{1-K}{\beta - \delta K} \in (\frac{1}{\beta}, \frac{1-\beta}{\beta(1-\delta)})$ , so that the DM will complete the task if and only if  $v \geq cX$ . The diagram which relates the reward to whether the task is completed or not now looks like this.

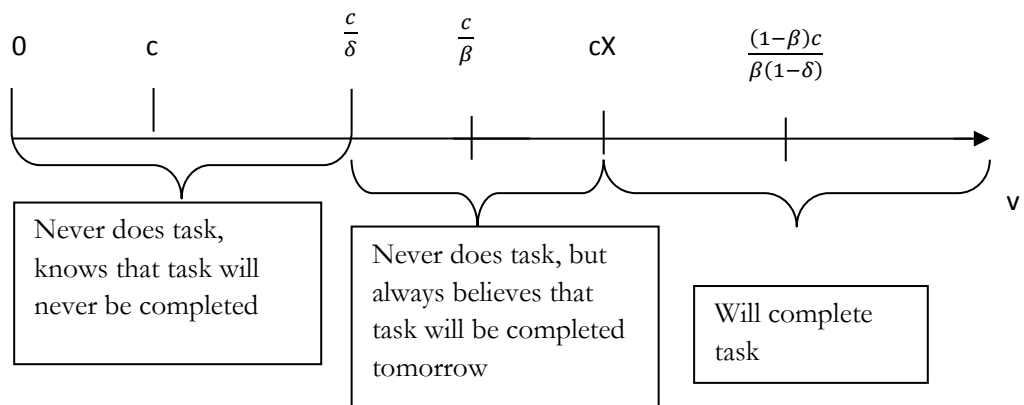

Figure 8: Task completion as  $v$  varies.



Notice, the region in which the task is completed is now enlarged. That is, there exist tasks which will now be completed (in the presence of forgetfulness) which would not be completed had the DM had a perfect memory. QED

#### 4.1 WELFARE ANALYSIS

Welfare analysis is somewhat complicated in models with non-constant discounting, as it matters from where you calculate it. In this model, a natural place would be at time 0. This would give the ex-ante utility to the DM at the start of the decision problem. Clearly, if the DM never completes the task (whether he thinks he will or not) he gets nothing. In the **perfect memory case** he either completes the task at the beginning or never again. How welfare varies with the value of the reward is shown in the figure below.

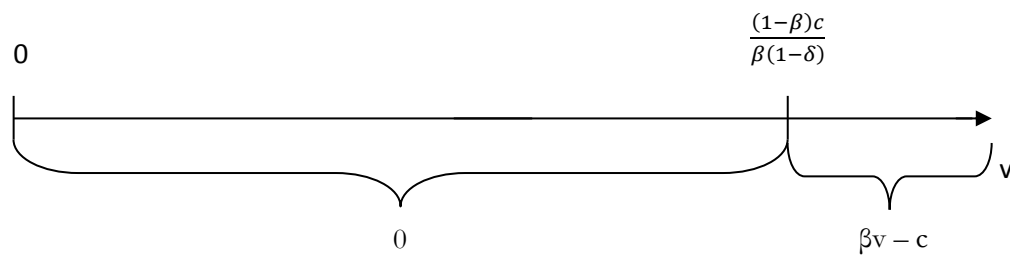

Figure 9: Expected payoff as  $v$  varies with perfect memory.

That is, if the value of the reward does not meet the threshold value for the DM to complete the task, he procrastinates forever and gets nothing. If it does exceed the threshold then he completes the task today and realised the payoff  $\beta v - c$ . The equivalent diagram for the DM who is forgetful is below.

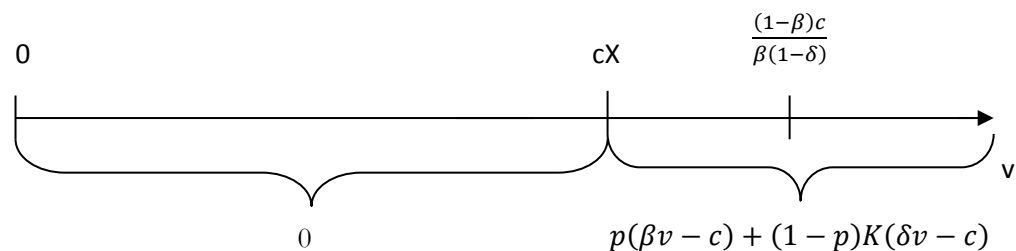

Figure 10: Task completion as  $v$  varies.

Here the critical value which determines whether the DM completes the task or not has changed to  $cX < \frac{(1-\beta)c}{\beta(1-\delta)}$ . If his valuation exceeds this threshold then he will complete the task at the first opportunity that he has (i.e. the first time that he remembers). With probability  $p$ , he remembers today (at time zero), yielding him a payoff of  $\beta v - c$ ; while with probability  $1 - p$ , he forgets and moves to the next time period. If he moves to the next time period we know that he will complete the task with probability  $p$  or else move another time period ahead with probability  $1 - p$ , and so on. This leads to an infinite series whose expectation is identical to that in equation (3). That is, the expression in (3) calculated the perceived payoff to a forgetful naïf when he chooses to delay. This is exactly the same as the expected payoff to the DM in the case that he forgets in the first time period, the difference being, that in the case where  $v > cX$ , the DM will actually complete the task if he remembers.

Clearly, the DM is better off being forgetful for all those tasks with  $v \in \left(cX, \frac{(1-\beta)c}{\beta(1-\delta)}\right)$ , as now, he is able to secure a positive payoff rather than nothing. Whether he is better off when  $v > \frac{(1-\beta)c}{\beta(1-\delta)}$  depends on if:

$$\beta v - c \geq p(\beta v - c) + (1 - p)K(\delta v - c)$$

It turns out that the LHS is greater when  $v > cX$ . Which means that for  $v > \frac{(1-\beta)c}{\beta(1-\delta)}$ , the DM is worse off if he has memory imperfections in addition to self-control problems, compared to if he had only self-control problems.

To summarise what we have found, the DM is better off having a bad memory and time-inconsistent preferences compared with just having time-inconsistent preferences alone when  $v \in \left(cX, \frac{(1-\beta)c}{\beta(1-\delta)}\right)$ . This is because he now completes the task rather than procrastinating forever. When  $v > \frac{(1-\beta)c}{\beta(1-\delta)}$ , the DM is worse off having a bad memory and time-inconsistent preferences compared with just having time-inconsistent preferences alone. This is because he would have

done the task anyway without having a bad memory. In this case, forgetting only delays the reward.

## **5 OPTIMAL CONTRACTS FOR NAÏVE CARELESS CONSUMERS**

Many subscription schemes charge as a default £x per month if you remain signed up e.g. DVD rental services, Satellite TV subscription, mobile telephone contracts; you do however typically retain an option to cancel (although often there is a minimum subscription period). Effectively, each month you are given the choice between ‘continue’ or ‘cancel’, however if you forget, the default is played for you: continue. Often these firms will offer contracts which give some incentive to sign up to these services. If you are forgetful and naïve, in that you think you will remember to cancel at the first opportunity after receiving the incentive, you may sign up when you otherwise would not have and continue to pay the subscription until you eventually remember to cancel. This analysis sounds similar to the kinds of contracts firms may want to offer time inconsistent consumers. By offering a reward right now and costs in the future, consumers may sign up to a service which they otherwise would not. Similarly, the naïve consumer may not cancel the contract when he plans to do so as cancellation is immediately costly at the time (e.g. making a phone call, cancelling a direct debit etc.). For these kinds of recurring payment contracts the behaviour of a forgetful naïf and a present-biased naïf will be similar. However, for a ‘stationary task’ (one that looks the same from the DM’s point of view at any point in time) the procrastinator is likely to procrastinate forever, while the forgetter will complete the task when he recalls it.

### **5.1 MOBILE PHONE CONTRACTS**

Mobile phone contracts with rebate are classic examples of this type of contract. In the mobile phone market, consumers typically have a choice between (i) Pay-as-you-go, where you ‘top-up’ your phone with credit, which typically will not expire, which you can then use until it is depleted, typically at a relatively high per-minute rate or (ii) a Fixed term contract, where you

enter into a contract for a period of between 12 and 24 months, at the end of each month you receive a bill for your usage that month. Included in the monthly payment is a package of minutes and texts (at a relatively low implied price per unit), which you are able to deplete during the month; any left unused that month, expires, while if you go over your monthly allocation you are charged per-minute. As consumers have increased their usage of mobile phones to make calls, fixed term contracts have become increasingly popular as they are cheaper if you are a medium to high usage user.

Now, within the fixed term contract market, we often see firms offering consumers incentives to subscribe, some of these incentives include temporarily reduced prices, free gifts (sometimes of substantial value e.g. games consoles, iPods etc.). One could try to explain these with reference to firms trying to exploit consumers time inconsistent preferences for immediate rewards or due to the switching costs involved in moving from one provider to another, which means that a customer on a contract may well stay on well beyond the minimum term of the contract. One particular incentive which is offered which seems to try to exploit different consumers' quality of memory and level of sophistication is called 'chequeback': you typically pay a high monthly rate, but you can claim most of this back if you remember to send them a form at particular times during the contract period, if you forget, you get nothing back and so you pay the high rate for the full contract period. Now, this type of contract would seem attractive to those with a good memory (since they are likely to receive their rebate) and those with a poor memory but who are naïve (since they think they are likely to receive their rebate). Whilst those with a poor memory but who are sophisticated about their memory problems will avoid such a contract since they realise they are unlikely to receive their rebate.

#### *A Simple model*

Consumers vary in their memory quality and their level of sophistication but not in their valuations (assume that consumers' valuation is  $p_M$  and that this is known to the firm), for simplicity we assume that there are 3 types of consumer:

- (i) Good memory (G) – always remembers if there is a task to complete (in this case it does not matter whether the agent is naïve or sophisticated, since he has a perfect memory in any case).
- (ii) Forgetful and naïve (FN) – remembers with probability  $\pi$  but thinks that he will always remember if there is a task to complete.
- (iii) Forgetful and sophisticated (FS) – remembers with probability  $\pi$  but knows that he remembers with probability  $\pi$ .

We assume that proportion  $\lambda_1$  of consumers are of type G,  $\lambda_2$  of type FN and  $\lambda_3$  of type FS. It is clear that the G and FN types will choose the same contract (their perceived decision problems are identical) and the FS may choose a different contract. So the firm can potentially offer two contracts to form a separating equilibrium.

Suppose that the firm is a monopolist who faces a unit demand, since we assume that consumers all have the same valuation  $p_M$  and that this is known to the monopolist, clearly the monopolist can offer a standard contract at price  $p_M$  and extract all the rent. However, it can also offer a non-standard menu of contracts: (i) which has price  $p_L$  if the consumer remembers to complete some costly administrative task (which if completed, costs  $c_C$  to the consumer and a processing cost to the firm of  $c_F$ ) and  $p_H$  otherwise; (ii) a standard contract offered at price  $p_S$ . Assume that firms fixed costs have been incurred and that marginal costs are zero. In the case where the firm only offers a standard contract clearly his profit will be  $p_M$ . While if he offers two contracts he faces the following problem (in a separating equilibrium):

$$\max_{p_L, p_H, p_S} (\lambda_1 + \pi\lambda_2)(p_L - c_F) + (1 - \pi)\lambda_2 p_H + \lambda_3 p_S$$

$$s. t. p_L + c_C \leq p_S \quad (IC_{G, FN})$$

$$\pi(p_L + c_C) + (1 - \pi)p_H \geq p_S \quad (IC_{FS})$$

$$p_H \leq \bar{p} \quad (B)$$

$$p_L, p_S \leq p_M \quad (PC_{ALL})$$

Inspecting the maximand we see that all the good memory types and fraction  $\pi$  of the forgetful naïfs are able to pay the low price, this is further reduced by the firm's administrative cost. Proportion  $1 - \pi$  of the FN types choose the non-standard contract and forget to do the task, for this reason they pay the high price. While the forgetful sophisticates, realise that given their forgetfulness they should take the standard contract. The first incentive constraint says that for the G and FN types to choose the contract meant for them, it must be that the low price plus the admin cost does not exceed the standard price. The second incentive constraint says that the FS type chooses the contract meant for him so long as the expected payment he makes if he chooses the 'betting' contract exceeds the price of the standard contract. The third constraint says that the high price 'punishment' in case of choosing the betting contract and forgetting should be bounded. This is a reasonable requirement: that the firm cannot bankrupt individuals for a minor infraction. The final constraint is a participation constraint which simply says that the price that all consumers expect to pay cannot exceed their reservation price. Solving this problem we have that

$$p_L^* = p_M - c_C; \quad p_H^* = \bar{p}; \quad p_S^* = p_M$$

The optimality conditions here are saying something very simple: in order to maximise profits the firm should charge the highest prices it can, subject to the agents participating and then choosing the contract meant for them. If the firm offers these two contracts it will receive profit:

$$(\lambda_1 + \pi\lambda_2)(p_M - c_C - c_F) + (1 - \pi)\lambda_2\bar{p} + \lambda_3p_M.$$

Which it will compare to the profit from offering one contract, which is simply  $p_M$ :

*Payoff from two contracts*  $\geq$  *Payoff from one contract*

$$(\lambda_1 + \pi\lambda_2)(p_M - c_C - c_F) + (1 - \pi)\lambda_2\bar{p} + \lambda_3p_M \geq p_M$$

$$\bar{p} - \frac{\lambda_1 + \pi\lambda_2}{\lambda_2(1 - \pi)}(c_C + c_F) \geq p_M \quad (4)$$

This confirms our intuition that all other things equal, the firm likes offering these kinds of contracts when: it can charge a high price to the FN types, there are many FN types and few G types, the FN types have a poor memory, and administrative costs to the firm and the consumer are low. Clearly these contracts cannot be first-best since the administrative costs on both sides are deadweight losses, which the firm is typically willing to bear in order to exploit the FN types. If firms offer these kinds of contracts, it is important that they estimate the proportions that will remember to do the task. If agents' memory quality or their sophistication is better than forecast, firms can make large losses. It is also important to consider if agents learn about their memory imperfections, so initially the firm could profit from such a contract but later make losses. Indeed, some firms offering these kinds of contracts have gone bankrupt and others have made their deals less attractive.

## 5.2 INTRODUCING COMPETITION

In the model so far the good memory type has not been able to extract any rents, he is indifferent between taking the contract meant for him and not, that is to say, the firm is able to extract all the surplus from the consumer (albeit compensating him for his administrative cost). This is because the firm has monopoly power and also because he knows the agents' valuations. In practice one finds that often these kinds of contracts can be very lucrative for the sophisticated types: it is not unusual to see mobile phone contracts being offered for free if certain administrative tasks are completed. Thus it may be instructive to compare the earlier model with one in which firms compete for customers.

Suppose instead that there are many firms offering these kinds of contracts. The first thing that we note is that in any separating equilibrium firms have no incentive to compete on the punishment i.e. the high price, this is because no type of consumer thinks that he will ever have to pay the high price. Thus the high price will always be set to its maximum ( $p_H^* = \bar{p}$ ). Next we note that a firm could always enter the market and only offer the standard contract, thus we expect competition to drive the standard contract price  $p_s$  down to marginal cost (which we have normalised to zero) ( $p_s^* = 0$ )

Supposing now that there are  $N$  firms which all offer both contract types, if these firms engage in price competition on the low price  $p_L$  (the other equilibrium prices have already been pinned down), profits to firm  $i$  will be given by

$$\pi^i = \begin{cases} k^{-1}[(\lambda_1 + \pi\lambda_2)(p_L^i - c_F) + (1 - \pi)\lambda_2 \bar{p}], & \text{if } p_L^i = \min\{p_L^1, \dots, p_L^N\} \\ 0, & \text{otherwise} \end{cases}$$

Where  $k$  is the number of firms offering the lowest price in case of a tie.

Here, there is a strong incentive to be cheaper than one's competitors. If a firm is not the cheapest, he does not make any profit. Equally, if he is making positive profits but there is some other firm also offering the same price and making positive profits, the firm has an incentive to just undercut his competitors so that he does not have to split the profits with  $k > 1$  firms. Similar to Bertrand competition, there is no equilibrium where firms are making positive profits: they continue to undercut one another until the point where undercutting any further would lead to negative profits. Thus in equilibrium it must be that

$$k^{-1}[(\lambda_1 + \pi\lambda_2)(p_L^* - c_F) + (1 - \pi)\lambda_2 \bar{p}] = 0$$

Rearranging, we have:

$$p_L^* = -\frac{(1 - \pi)\lambda_2 \bar{p}}{\lambda_1 + \pi\lambda_2} + c_F$$

Recalling that  $p_L + c_c \leq p_S = 0$  must hold in order for this type of contract to be taken, it must be that  $p_L^* \leq -c_c$ , or equivalently that

$$\bar{p} - \frac{\lambda_1 + \pi\lambda_2}{\lambda_2(1 - \pi)}(c_C + c_F) \geq 0$$

Inspecting expression (4) we see that the above condition must hold if industry profits from offering two contracts are at least as large as industry profits from offering one contract. We see that, potentially the  $G$  type is able to gain large amounts of rent, the surplus he gains is increasing in the firm's ability to punish the  $FN$  types harsher (increasing in  $\bar{p}$ ), and as the proportion of  $FN$  types increases (increasing in  $\lambda_2$ ). And decreasing in memory quality of the



forgetful type,  $\pi$  as well as the proportion of G types,  $\lambda_1$ . These results are in keeping with our intuition since what is effectively occurring is a transfer from the FN types to the G types, the larger the number of FN types and the more likely the FN type is to incur the punishment price and the larger the level of that price, the more surplus that is able to be transferred to the G type. Similarly, the smaller the number of G types, the larger each transfer. That is to say, the firms are willing to make a loss on the good memory types in order that they can extract large payments from the forgetful naïve types.

The welfare implications of the existence of these kinds of contracts are two-fold. Firstly, the administrative costs which are born by both sides of the market are a pure deadweight loss; there is no welfare benefit for anyone, only a cost to the person completing the task. Secondly, as we have seen, there is a transfer from the FN types to the G types. Since it is not unreasonable to suppose that there is going to be a positive correlation between general cognitive ability and memory quality as well as sophistication, the redistribution is going to be from those with low ability to those with high ability i.e. from the poor to the rich. Clearly this will be undesirable if one's social welfare function has any degree of inequality aversion.

# CHAPTER 6: A SIMPLE CONSUMPTION PROBLEM WITH MEMORY IMPERFECTIONS

## 1 INTRODUCTION

The UK market for bank accounts for consumers, in many ways, seems too good to be true. It is standard practice for most banks to offer a bank account with a debit card, chequebook, credit card and other services through a network of branches, internet and telephone banking all seemingly free of charge. Indeed, it is not unknown for banks to offer customers an incentive payment to make use of such accounts.<sup>30</sup> Since these are all costly services to provide, including at the margin, it seems contrary to economic theory that they would be priced below marginal cost even if the market was perfectly competitive. In reality however, there are a few large firms which dominate the high-street banking market, some of which operate under multiple brand names.

It can be argued that consumers ‘pay’ for these services indirectly, typically little or no interest is paid when accounts are in credit, and firms would typically have to pay to borrow these amounts otherwise. This can amount to substantial implied payments by consumers. However, there seems to be a problem even with this line of reasoning, because firms typically also offer savings accounts (again free of charge) which offer market rates of return. The proliferation of internet banking means that it is typically easy to transfer funds in and out of these accounts. Thus a savvy consumer could keep the bulk of their funds in the high-return savings account, while only keeping what he needs for immediate expenditure in his low-return current account. What the consumer will not want to do, however, is to leave insufficient funds in the current

---

<sup>30</sup> Santander and First Direct were both offering reward payments of £100 as of 11/01/11

account to cover his spending. If he does this, he will typically become overdrawn and subject to often substantial penalty charges.<sup>31</sup>

In this chapter I present a simple model which looks at the incentives faced by consumers who use these kinds of banking services. I group consumers into three types and discuss each case. Initially, I look at a general model and attempt to draw some conclusions. After this, I move onto a more restricted model in the hope of drawing some stronger conclusions.

## 1.1 RELATED LITERATURE

There is already some literature on these kinds of problems. Ameriks et al. (2004) looks at the problem of the ‘absentminded consumer’. They develop a life-cycle model to look at how absentmindedness affects consumption behaviour. In their model, absentminded consumers exhibit ‘precautionary spending’, that is, they overspend on average compared to their attentive counterparts. The intuition for their result is that this protects the absentminded consumer from sub-optimally low consumption in the future. This is a peculiar result; indeed in our model we find the opposite. We find that forgetful agents, who are aware of their forgetfulness, optimally reduce their consumption in response to a lower expected net present value of assets. Their paper is different to ours, in their model the consumers’ forgetfulness is modelled as not knowing where they are in the game-tree i.e. they follow Piccone and Rubinstein.

Reis (2006) looks at the problem of an ‘inattentive consumer’ who finds it costly to acquire, absorb and process information. He finds that it may be optimal for such consumers to choose not to plan, while those who do plan may only update their plans infrequently. His model is able to explain the excess sensitivity and excess smoothness puzzles in consumption behaviour. Alvarez et al. (2012) use data from two new household surveys that record how frequently investors observe the value of their portfolios and the frequency that they trade, in order to test the predictions of different models. They find that in order to fit the data, the models need to be adjusted so that more emphasis is placed on durable consumption.

---

<sup>31</sup> An article in The Guardian on 23 November 2009 states that ‘Estimates suggest they [banks] have been making £4.7bn a year from fees of as much as £39 for a bounced cheque and £28 a day for an unauthorised overdraft, even though the administration costs are just a couple of pounds.’

## 2 THE GENERAL MODEL

Time is discrete  $t = 0, 1, 2, \dots$ . The DM has access to two accounts:

1. A current account (CA) from which he can spend. This account offers no return on positive balances but the consumer will be charged a fine of  $F > 0$  for each time period in which he has a negative balance (in addition to any interest charges). We call the balance of the CA at the start of period  $t$ ,  $m_t$ .
2. A savings account (SA) which offers a rate of return,  $r$ , but which cannot be used for current spending. We call the balance of the CA at the start of period  $t$ ,  $k_t$ .

Moving funds from one account to another is costless and immediate. However transfers can only be done in time periods where the DM remembers to do this. If he does not remember, no transfers can take place. Let  $T_t$  be the amount of the transfer from the savings account to the current account in period  $t$ . The DM begins with assets  $A_0$ . In each time period nature first determines if he remembers to make adjustments to his holdings and future consumption plan. Then he consumes  $c_t$  (according to his most recent consumption plan). The timeline shows the sequencing in each period:

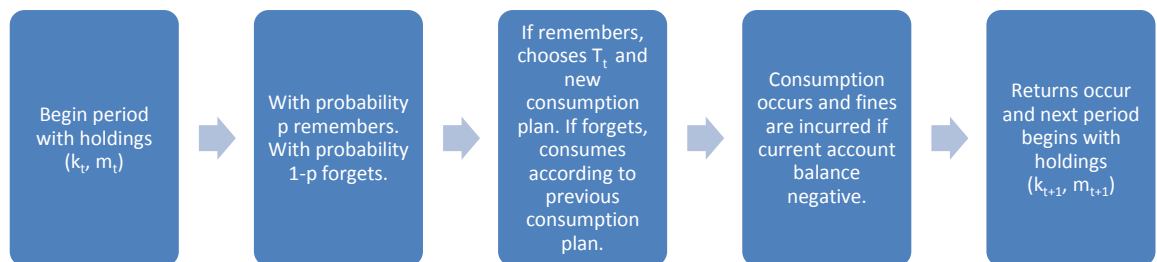

Figure 1: Timing in each period.

The current account balances evolves according to:

$$m_{t+1} = \max\{m_t - c_t + T_t, 0\}$$

That is, in any time period, the current account balance will be depleted by the consumption in that period but may be increased by any transfer in that period from the savings account to the current account. Clearly, in any time-period in which the consumer forgets, it must be that  $T_t = 0$ . Furthermore, if the current-account balance becomes negative in any time-period  $t$ , we know that a fine  $F > 0$  is payable. We assume that the bank automatically reallocates sufficient funds from the savings account to the current account to cover the fine and to bring the current account balance to zero. This is a reasonable assumption since it minimises the returns that the bank must pay on the consumer's savings.<sup>32</sup> Of course, if the consumer does not have enough funds to cover the fine and the negative balance, he is bankrupted. The savings account balances evolves according to:

$$k_{t+1} = (1 + r)(k_t - T_t + \mathbf{1}[m_t - c_t + T_t < 0](m_t - c_t + T_t - F))$$

That is, in any time period  $t$ , the savings account balance will be depleted if the consumer decides to transfer any funds into his current account. Furthermore, if he goes into his overdraft ( $m_t - c_t + T_t < 0$ ), this – and the fine  $F$  – is paid for from his savings account automatically. Finally, the consumer earns returns on any remaining balance. Let us consider how the DM is going to act in three cases:

#### a. GOOD MEMORY (G)

In this case, the DM remembers in each time period and can adjust his holdings appropriately – thus he will want to move as much resources as he can into the SA (yielding him return  $r$ ) and leave only enough for current consumption in the CA. Thus, he will get his free banking services while guaranteeing himself a market return on all his savings. This problem collapses to the standard intertemporal consumption problem where the DM will choose his consumption plan  $\{c_t\}_{t=0}^{\infty}$  to satisfy his budget constraint and the Euler equation

---

<sup>32</sup> In fact, in the UK there is legislation which allows financial institutions to transfer funds between a consumer's accounts without their consent if the balance of one of their accounts is negative and the other is positive.

$$u'(c_t) = \frac{1+r}{1+\rho} u'(c_{t+1}), \quad \forall t.$$

Where  $r$  is the market rate of return on savings and  $\rho$  is the consumer's discount rate. Moreover, he will actually be able to implement this plan. The bank in this case will make a loss on this type of consumer since it will provide him with costly banking services free of charge.

### *Baseline optimisation*

The problem faced by the good-memory types is standard in the literature; however, we briefly present it here since it will be instructive to compare our later results to this baseline case. Since the good memory type need not worry about forgetting, he can calculate his optimal consumption profile, and in each period allocate exactly the funds required for today's consumption to his current account. Thus, at the start of any time period his current account balance will be zero ( $m_t = 0$ ). As a result, his total assets at the start of period  $t$  will equal the balance of his savings account at the start of time  $t$  ( $A_t = k_t$ ). Hence, we can write down the dynamic problem facing the consumer in terms of the state variable  $k$ . Let  $V(k)$  be the consumer's value function (viewed from his current perspective) at the start of a time period when his savings account balance is  $k$ . Then,  $V(k)$  satisfies the condition

$$V(k) = \max_c u(c) + \delta V(k') \quad s.t. \quad k' = (1+r)(k-c) \quad \text{for all } k \geq 0.$$

Where  $k'$  denotes the next period value for  $k$ . We can rewrite this as

$$V(k) = \max_{k'} u\left(k - \frac{k'}{1+r}\right) + \delta V(k').$$

Corresponding first order and envelope conditions are

$$\delta V'(k') = \frac{u'(c)}{1+r}, \quad V'(k) = u'(c).$$

Combining these gives the familiar Euler equation, which tells us that optimally, the ratio of marginal utilities between consumption in one period and the next should equal the discounted return on saving.

$$\delta(1+r) = \frac{u'(c)}{u'(c')}.$$

The Euler equation itself will not be enough to characterise the optimal choice of consumption path. In addition we will need to know the budget constraint. The standard intertemporal budget constraint for this problem tells us that the net present value of consumption should equal the net present value of the consumer's assets/income. Since we assume that the consumer simply starts with assets equal to  $A_0$  and receives no income, the budget constraint will be:

$$\sum_{t=0}^{\infty} \frac{c_t}{(1+r)^t} = A_0.$$

Knowledge of the intertemporal budget constraint along with the Euler equation allows us to find the consumer's optimal consumption path  $\{c_t\}_{t=0}^{\infty}$ , which in the baseline case, the consumer will have no problem implementing.

## **b. FORGETFUL AND NAÏVE (FN)**

In this case the DM is forgetful in that he only remembers to make adjustments to his holdings with probability  $p$ . He is naïve in that he believes that he has a perfect memory and therefore attempts to behave as such. Because of his naivety, when he chooses his optimal consumption plan  $\{c_t\}_{t=0}^{\infty}$ , he believes that he will be able to optimally intertemporally smooth his

consumption (and likewise achieve a return  $r$  on any saving) to satisfy the Euler equation. Again, because of his naivety, in any period where he remembers to adjust his holdings, he will choose to move all of his assets, less current period consumption, to his SA. Therefore, at the beginning of each time period he has, at most, zero in his CA. That is, at most, he has kept sufficient funds in his CA to cover one-period of consumption. It follows that he will incur fines in every time period in which he forgets. In time periods where he remembers, he will adjust his holdings so that only  $c_t$  remains in his CA and he will adjust his future consumption plan to satisfy the Euler equation once more. If he has not incurred a fine since the last time he remembered (i.e. he remembered in the previous time period), his consumption plan will remain unchanged. If however, he forgot in the previous time period he will need to change his consumption plan and because of the fines incurred since his last re-optimisation, his new consumption plan will consume less in each period. Such a consumer is certainly worse off compared to the good memory types whom they would ideally like to imitate, however, their memory imperfections make that impossible. Furthermore, the forgetful naïve type will typically become bankrupt. Consider the following example.

**Example 1:** Assume  $r = \rho$ , that is, the rate of return on savings exactly equals the consumers discount rate. We know that a forgetful naïve consumer will attempt to implement a consumption stream consistent with the Euler equation

$$u'(c_t) = \frac{1+r}{1+\rho} u'(c_{t+1}), \quad \forall t.$$

Since, for this consumer,  $r = \rho$ , we have that

$$u'(c_t) = u'(c_{t+1}) \Rightarrow c_t = \bar{c}, \quad \forall t.$$

That is, he would like to perfectly consumption smooth. (Perceived) optimality requires that the level of consumption is chosen to bind the (perceived) budget constraint



$$\sum_{t=0}^{\infty} \frac{\bar{c}}{(1+r)^t} = A_0$$

Solving for  $\bar{c}$

$$\bar{c} = \left( \frac{r}{1+r} \right) A_0$$

That is, he will choose consumption today equal to a fraction of his total assets. Notice that the problem is stationary so that whenever he remembers, he will revise his consumption by looking at his total assets and consuming a fraction  $r/(1+r)$  of them. Notice also that, if the consumer had been a good-memory type, this is precisely the level of consumption which ensures that the consumer's total assets remain constant over time. That is, in the standard intertemporal problem

$$A_{t+1} = (1+r)(A_t - c)$$

Substituting

$$c = \left( \frac{r}{1+r} \right) A_t$$

We see that

$$A_{t+1} = (1+r) \left( A_t - \left( \frac{r}{1+r} \right) A_t \right) = A_t.$$

Hence, when a forgetful naïve consumer tries to implement this plan, his assets will typically fall over time due to the cumulative fines he will incur. Similarly, his consumption will fall over time as whenever it is revised, it will be a fixed fraction of a smaller stock of assets. Eventually the fines will cause him to become bankrupt. Here is a typical realised consumption path for a forgetful naïve consumer who wishes to perfectly consumption smooth:

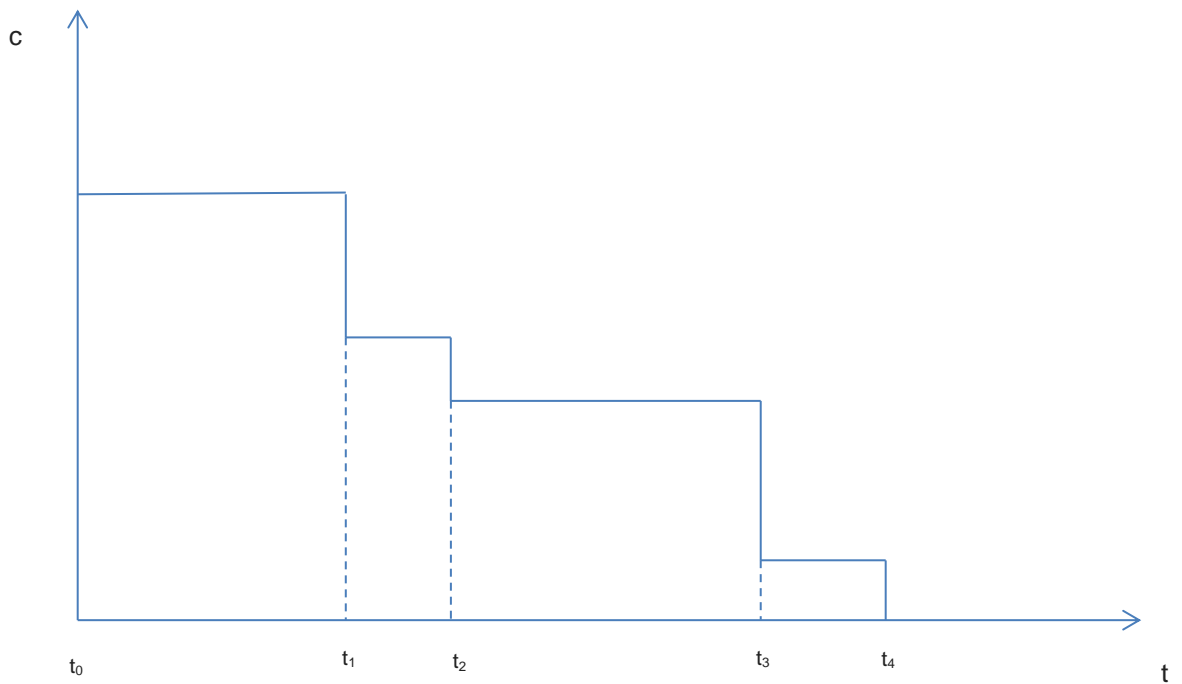
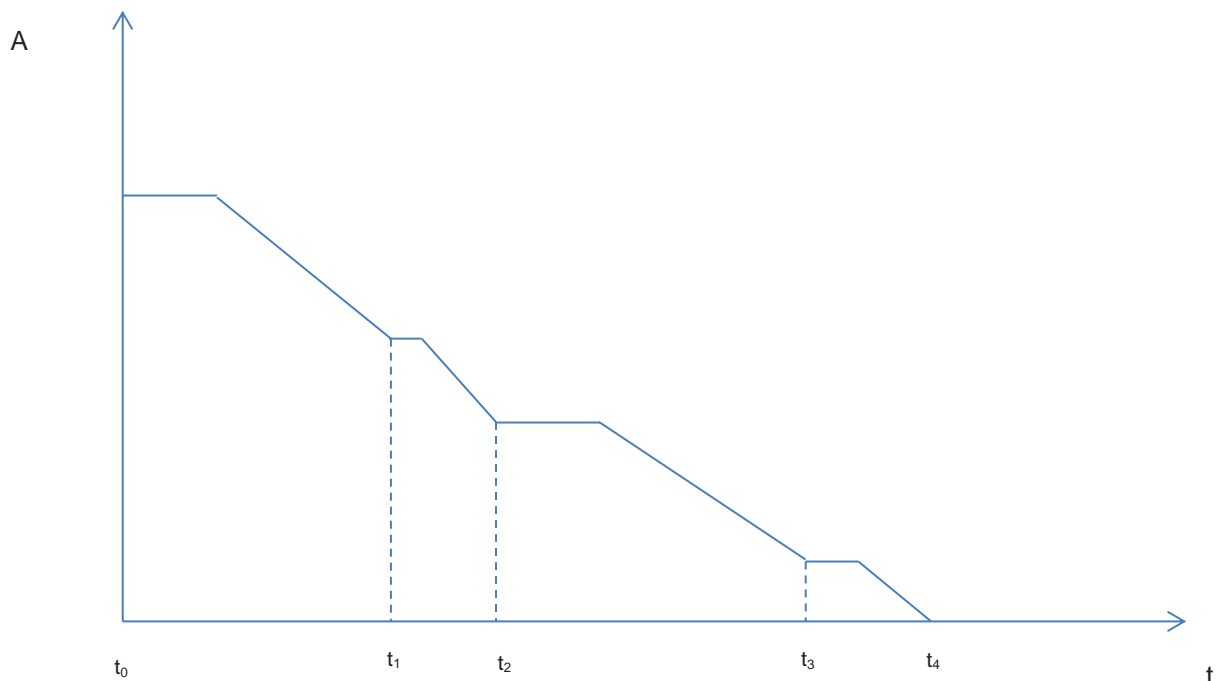

Figure 2: Typical realised consumption path for a forgetful naïve consumer.

The downward revisions in consumption (at times  $t_1$ ,  $t_2$ , and  $t_3$ ) indicate time-periods when the consumer remembers and finds that he has been fined since his most recent revision and thus his assets have partially depleted. He responds by reducing his consumption level. Eventually he depletes his assets completely and is bankrupt at time  $t_4$ . Notice that, the fact that consumption is constant between one revision and the next is informative about the realised memory process. For example, look at consumption during the interval of time  $[t_2, t_3]$ . We know for sure that the consumer remembered at time  $t_2$  and  $t_3$ , we know this because consumption can only be revised at those times when the consumer remembers. We also know that, in at least one time-period in this interval, the consumer forgot and was fined; we know this because his consumption has been revised downwards at time  $t_3$ . Furthermore, we know that  $t_3$  is the first time that the consumer remembered after (potentially, a number of periods of) forgetting. That is, it is not necessarily true that the consumer was in a constant state of forgetfulness in the time that elapsed between the two revisions, although that is a possibility. Rather, if he remembered in the time that elapsed between the two revisions, then those time-periods where he remembered must occur immediately after the revision at time  $t_2$ . Another way of saying this

is that the first time he forgets in the interval, must be followed by time-periods of only forgetting until time  $t_3$  when he remembers again. The reason this must be true is that if there was a time-period where the consumer forgot which was followed by a time-period where the consumer remembered which was not  $t_3$ , the consumer would have downwardly revised his consumption at that time. It is instructive to consider a potential asset path which corresponds to the consumption path presented in Figure 2. We present it below and then discuss what we can learn from it.



**Figure 3: Typical realised asset path for a forgetful naïve consumer.**

Inspecting Figure 3, we notice that assets are either falling or remaining constant. When assets are falling, it must be that he is in a state of forgetfulness. While, when they are constant, he is in a state of remembering. Taking a closer look at what happens in the interval of time  $[t_2, t_3]$ , we see that initially, assets remain stable. This is because at time  $t_2$  the consumer was in a state of remembering and chose the level of consumption consistent with a constant asset path, assuming (incorrectly) that he would remember in every period in the future. So long as he

continues to remember after time  $t_2$ , assets will remain constant since, he is able to optimally move assets between his accounts. The first time he forgets in the interval, he gets fined. This causes his total assets to fall. We know that the first time he is fined in an interval of time between revisions must be followed by periods of only forgetting until the next revision. This explains why assets fall until time  $t_3$ .

We can apply similar reasoning to a consumer who does not wish to perfectly consumption smooth, but instead discounts the future relatively highly so that  $\rho > r$ . In this case, ideally, the consumer would like to implement a consumption stream which is decreasing over time. Even in the baseline case, due to the frontloading of consumption, this will lead to a decreasing asset position over time. However, the consumer in the baseline case will typically not choose to bankrupt himself due to the high marginal utility he derives by increasing consumption a small amount when consumption in a period is low or zero. That is, far in the future, even when his total assets are small, he will choose his consumption so that he can still save something for the future. Since in our model, the fines are a fixed amount, this type of consumer will also certainly bankrupt himself. That is, for this kind of consumer, his assets will be falling in any case, but adding fixed amounts of fines every time he forgets ensures that he will become bankrupt.

For the consumer who discounts the future relatively little so that  $\rho < r$  things are a little more complicated. In this case, ideally, the consumer would like to implement a consumption stream which is increasing over time. In the baseline case this would lead to assets increasing over time. Now, it is unclear whether the fines would sufficiently decrease the consumer's assets to bankrupt him given that he is choosing to save a relatively large portion of his assets.

It is no surprise that forgetful and naïve consumers typically get a bad deal. The bank provides them with 'free' banking services, but they pay the bank a penalty  $F$  in every period that they forget. Furthermore, since the forgetful naïve consumer never considers the size of the penalty when they make choices, the bank could choose very large values of  $F$  without worrying that

competitive pressures will cause the consumer to switch to a competitor. In addition, while all forgetful and naïve consumers are potentially lucrative for the bank, the bank finds those who have large amounts of assets, who are very forgetful and who do not discount the future very much, particularly lucrative. The reason for this is that, consumers who have small amounts of assets and/or are very impatient are likely to become bankrupt much sooner. In the case that they are particularly forgetful, clearly they are fined more often and sooner in time. That the bank prefers consumers with large amounts of assets who are very forgetful is trivial, however, that they prefer patient consumers is less so. The reason that the bank prefers patient consumers is that they do not consume very much today and save (and earn a return on) a large proportion of their assets. This means that they are bankrupted much later, if at all. Since the bank earns a fine every time the consumer forgets, all other things equal, the bank prefers consumers who save a lot and thus can be exploited for longer.

### c. FORGETFUL AND SOPHISTICATED (FS)

In this case the DM is forgetful and knows that he is forgetful, so he is able to adjust his plans in order to take this into account. The first thing we need to discuss is what kinds of consumption profile will the consumer actually be able to implement? One option would be to give the consumer ‘full flexibility’, that is, he can choose whatever consumption profile he wants, in the knowledge that it will be implemented (as the default strategy) in case he forgets to reoptimise. Now, such flexibility has certain implications. Firstly, it means that optimally, the consumer must hold in his current account exactly the correct funds to cover some integer number of time periods of consumption.

**Implication 1:** *If a forgetful and sophisticated DM remembers at time  $\tau$  and chooses future consumption plan  $\{c_t\}_{t=\tau}^{\infty}$  and asset holding  $(m_{\tau}, k_{\tau})$ , then optimally, it must be the case that  $m_{\tau} = \sum_{t=\tau}^{\tau'} c_t$  for some  $\tau' = \tau, \tau+1, \dots$*

**Proof:** Suppose that it was not the case that  $m_\tau = \sum_{t=\tau}^{\tau'} c_t$  for some  $\tau' = \tau, \tau+1, \dots$  then the DM can unambiguously increase his expected payoff by reducing  $m_\tau$  to the nearest value which satisfies  $m_\tau = \sum_{t=\tau}^{\tau'} c_t$  for some  $\tau' = \tau, \tau+1, \dots$  and moving those realised funds into the SA. This is because the expected penalty paid from going into overdraft is the same in both cases but the returns are higher when more funds are kept in SA. ■

And secondly, if the fine for going overdrawn is sufficiently severe, then the chosen default consumption stream must drop to zero once the funds in the current account will be exhausted.

**Implication 2:** For  $F$  sufficiently large, the optimal consumption plan consistent with holdings  $m_\tau = \sum_{t=\tau}^{\tau'} c_t$  will be of the form  $c_\tau^* = (c_\tau, c_{\tau+1}, \dots, c_\tau, 0, 0, \dots)$ .

**Proof:** Notice that the chosen consumption plan will only be implemented if the decision maker forgets in every period, thus, consumption in each period should be chosen conditional on forgetting in every period between now and then. When the penalty from going overdrawn  $F$  is sufficiently large, the DM will never want to go overdrawn and would prefer to choose zero consumption. ■

There is a potentially serious problem with this analysis: is it really reasonable that a decision maker who forgets that he does not have enough money in his current account to fund any consumption, at the same time remembers that he should now consume nothing? This is not reasonable; moreover, if the consumer were indeed to remember that he is supposed to consume nothing today to avoid breaching his overdraft, it is reasonable to suppose that he will reason that some funds should be moved to his CA. Thus, there is a strong case for requiring that these ‘default’ consumption plans follow simple rules such as a constant consumption profile or, somewhat less simple, an increasing or decreasing consumption profile which satisfies the DM’s Euler equation at the time of the most recent revision. These modelling issues are reminiscent of some of the issues which arose in the *absent minded driver* problem.

Recall that in Halpern (1997), the decision maker is able to simulate perfect recall by encoding useful information into his choice of strategy at any particular time. This seems a bit like cheating and bypasses the substantive problems facing the decision maker. For example, in our problem, if the consumer is able to have full flexibility in his choice of (default) consumption which gets implemented when he forgets, and furthermore he is able to specify (default) transfers from his SA to his CA when he forgets, then he too will be able to simulate the behaviour of the good memory type. We proceed by restricting the DM to only being able to choose (default) consumption plans which are constant. There are two interrelated issues that we need to consider: First, at what level should consumption be set? Second, how much ‘reserves’ should be kept in the CA? (i.e. how many periods should the consumer be able to forget without incurring a fine?). Clearly there is a trade-off here, the more the DM keeps in his CA the less likely he is to receive a penalty but this will also reduce his returns on his assets.

The optimisation facing the consumer has an HJB equation:

$$V(A) = \max_{c,m} \sum_{\tau=1}^{\infty} \pi_{\tau} [u(c)(1 - \delta^{\tau}) + \delta^{\tau} V(A_{\tau})], \quad \forall A$$

Subject to

$$A_{\tau} = (1 + r)^{\tau}(A - m) + \mathbf{1}[c\tau \leq m](m - c\tau) + \mathbf{1}[c\tau > m] \left( m - c\tau - F \left( \tau - \left\lfloor \frac{m}{c} \right\rfloor \right) - I_{\tau} \right), \forall \tau$$

Where:  $\pi_{\tau}$  is the probability that the next time the consumer remembers is at time  $\tau$ ;  $\mathbf{1}[\cdot]$  is the indicator function;  $\lfloor \cdot \rfloor$  denotes the floor function;  $I_{\tau}$  denotes the (cumulative) interest penalty that the bank levies on negative balances in addition to any fines for being overdrawn.

This is not a straightforward object to calculate. Even ignoring the bankruptcy issue, the dynamic problem is exceptionally difficult to solve. Given the complexity, in the next section, we will attempt to solve a restricted model instead of solving the full dynamic programming problem. We restrict attention to two very simple strategies which we call the ‘one-period rule’

and 'two-period rule'. We also simplify the memory process so that it is not possible for the consumer to forget for two or more time-periods consecutively. Finally, instead of a sequence of budget constraints we constrain the consumer with a single, expected intertemporal budget constraint. Before moving on, we note that even in the general case, we can say something about the relative welfare of the different consumer types. Clearly, the FS type has lower welfare than the G type since he has to hold funds inefficiently in his CA as well as incurring possibly penalties, but he is better off compared to the FN type who does not optimise to take into account his memory imperfections. From the point of view of the bank, the FN types are the most lucrative followed by the FS types. The bank makes a loss on the G types. There is a further consideration here, which is, out of all of the types, only the FS types choose to hold funds in the CA over time. Because of this, the bank is effectively able to borrow from the FS types for free.

### **3 A RESTRICTED MODEL**

We have noted that the problem facing the forgetful and sophisticated consumer is difficult to solve. In any period when he remembers, he needs to look at the total amount of assets he has at that time  $A_t$ , and decide how to split those assets between his current account and savings account. He also needs to choose the level at which he will consume, in the knowledge that that level will persist until the next time he remembers. Furthermore he needs to take into account the fines that will accrue to him if his current account balance is negative.

We proceed by looking at a simplified model where if the consumer remembers at time  $t$ , he knows for sure that he will remember tomorrow and/or the day after for sure. In particular we assume that if the consumer remembers today he will remember tomorrow with probability  $p$ . With probability  $1 - p$  he forgets tomorrow, but if he forgets tomorrow, he remembers for sure the day after. Given this memory process, it is easy to see that it is never optimal for the consumer to hold more than two period of consumption in his current account. Doing so



would only reduce the returns on his savings and there would be no need, as exactly two period of consumption in the current account would insure him against any fines. As we have already argued, in the discrete time setting, the optimal amount of resources in the current account must be some integer multiple of the consumption level chosen. Thus the optimal level of funds to be kept in the current account must be either one or two periods of consumption.

We cannot rule out that sometimes the consumer may want to allocate one-period of consumption to his current account and at other times two-periods. However, this adds substantially to the modelling complexity and therefore we restrict our consumer to choosing between simple rules which always allocate either one-period or two-periods of consumption to the current account. We turn our attention first to the consumer's problem if he follows the 'one-period rule'.

### **3.1 ONE-PERIOD RULE**

If, whenever he remembers to do so, the consumer always allocates exactly one-period of consumption to his current account; his consumption in that time period will exhaust his current account completely. This means that at the start of any time period, whether or not he remembered yesterday, his current account balance will be zero. This observation means that total assets at the start of a period is exactly equal to the balance of the savings account. It also means that there will be a one-for-one relationship between forgetting and being fined, that is, he will be fined in that period if and only if he forgets in that period.

Before moving to our result about optimal choice for a consumer following this rule, we define some variables. Let  $c$  denote the optimal choice of consumption today (if the consumer remembers today) as well as 'default' consumption tomorrow if he forgets tomorrow;  $c'$  denotes optimal consumption tomorrow (if the consumer remembers today and tomorrow) and  $\tilde{c}''$

denotes optimal consumption the day after tomorrow (if the consumer remembers today and forgets tomorrow, which guarantees that he will remember the day after).

**Result 1:** *When following the one-period rule, the consumer's optimal choice satisfies the adjusted Euler equation:*

$$\frac{u'(c)}{pu'(c') + (1-p)(1+r)\delta u'(\tilde{c}'')} = (1+r)\delta \quad (1)$$

**Proof:** We can write the consumer's dynamic problem as:

$$V^R(k) = \max_c u(c) + p\delta V^R(k') + (1-p)\delta V^F(k')$$

Where  $V^R(k)$  and  $V^F(k)$  are the values of being in the 'remember state' and 'forget state' respectively while having assets  $k$ . While following the one-period rule, it must be that:

$$V^F(k') = u(c) + \delta V^R((1+r)(k' - c - F))$$

That is, if the consumer is in the forget state today, he will consume according to his consumption choice in the previous period, yielding  $u(c)$ . Furthermore, the consumer will remember for sure tomorrow. The consumer's savings today equal  $k' - c - F$ , i.e. he consumed  $c$  today but he also paid a fine  $F$  because he forgot and did not have enough funds in his current account to fund his consumption today. Yielding him assets tomorrow of  $(1+r)(k' - c - F)$ . This gives us that

$$V^R(k) = \max_c u(c) + p\delta V^R(k') + (1-p)\delta [u(c) + \delta V^R((1+r)(k' - c - F))]$$

Since  $k' = (1+r)(k - c)$  we can rewrite our problem:

$$V^R(k) = \max_{k'} u\left(k - \frac{k'}{1+r}\right) + p\delta V^R(k') + (1-p)\delta \left[ u\left(k - \frac{k'}{1+r}\right) + \delta V^R((1+r)(k' - c - F)) \right]$$

The first order condition tells us that:

$$\left( \frac{1 + (1-p)\delta}{1+r} \right) u'(c) = p\delta V^{R'}(k') + (1-p)\delta [(1+r)\delta V^{R'}(\tilde{k}'')] ]$$

Where  $\tilde{k}'' = (1+r)(k' - c - F)$  is assets the day after tomorrow after being fined tomorrow.

The corresponding envelope condition being:

$$V^{R'}(k) = [1 + (1-p)\delta]u'(c)$$

Combining the FOC and envelope condition tell us that the optimal consumption choices satisfy:

$$\frac{u'(c)}{pu'(c') + (1-p)(1+r)\delta u'(\tilde{c}'')} = (1+r)\delta$$

■

The optimality condition has a strong resemblance to the standard intertemporal Euler equation. The difference is that in place of the marginal utility of consumption tomorrow we have a probability weighted average of marginal utility tomorrow and the day after. Notice that  $u'(\tilde{c}'')$  takes into account the fact that it is ‘one-period ahead’ of the standard Euler equation by being further discounted ( $\delta$ ) as well as being scaled up by an additional one-period return ( $1+r$ ). The Euler equation for the standard intertemporal problem tells us that the consumer’s marginal rate of substitution between consumption today and tomorrow should equal the rate at which the market is willing to exchange consumption today for consumption tomorrow. Our

optimality condition (1) is saying something very similar except that it is now true in expectation. We now assume the consumer's discount rate equal the rate of return on savings:

**Assumption 1:**  $(1 + r)\delta = 1$ .

In the baseline model this means that the consumer would like to perfectly consumption smooth and choose a constant path for consumption. If we apply it to the modified Euler equation (1), we have that

$$u'(c) = pu'(c') + (1 - p)u'(\tilde{c}'') \quad (2)$$

This simple expression tells us something rather interesting about how the consumer's consumption responds to these 'memory shocks'. It says that the marginal utility from consumption today must be a weighted average of the marginal utilities from consumption tomorrow and the day after, conditional on that being the first time the consumer gets to revise his consumption choice. This means that remembering tomorrow is 'good news' and results in an increase in consumption, whereas forgetting tomorrow and therefore remembering for sure the day after is 'bad news' and results in a fall in consumption. We can see this more formally in the following result.

**Result 2:** *A consumer who satisfies Assumption 1 must have that  $c' > c > \tilde{c}''$ .*

**Proof:** First, we note that consumption choice in these states is going to be an increasing function of total assets,  $k$ , at that time. The stationary nature of the problem – that the decision problem looks the same to the consumer whenever he is called upon to act – means that showing that  $c' > c > \tilde{c}''$  is equivalent to showing that  $k' > k > \tilde{k}''$ .

Now I argue that  $k' > k$ :

$$\begin{aligned}
& k' > k \\
& \Leftrightarrow (1+r)(k-c) > k \\
& \Leftrightarrow c < \frac{rk}{1+r}
\end{aligned} \tag{3}$$

This must be true, this is because  $c = \frac{rk}{1+r}$  is the utility maximising choice of consumption when the consumer wishes to perfectly consumption smooth in this problem and does not suffer from any memory problems. That is, the NPV of consuming  $\frac{rk}{1+r}$  in every period is exactly equal to capital today,  $k$ :

$$\frac{rk}{1+r} + \frac{rk}{(1+r)^2} + \frac{rk}{(1+r)^3} + \dots = k.$$

Memory imperfections – which lead to fines in expectation – must make the consumer worse off. A forgetful sophisticated consumer will take into account his forgetfulness by reducing his consumption. We have shown that  $k' > k$ , from (2) we know that  $c$  must be a weighted average of  $c'$  and  $c''$  which implies that that  $k$  must be a weighted average of  $k'$  and  $\tilde{k}''$ , which gives us that  $k' > k > \tilde{k}''$ . QED

Below we graph a typical realised consumption path for a forgetful sophisticate who is following the one-period rule, and would ideally like to perfectly consumption smooth.

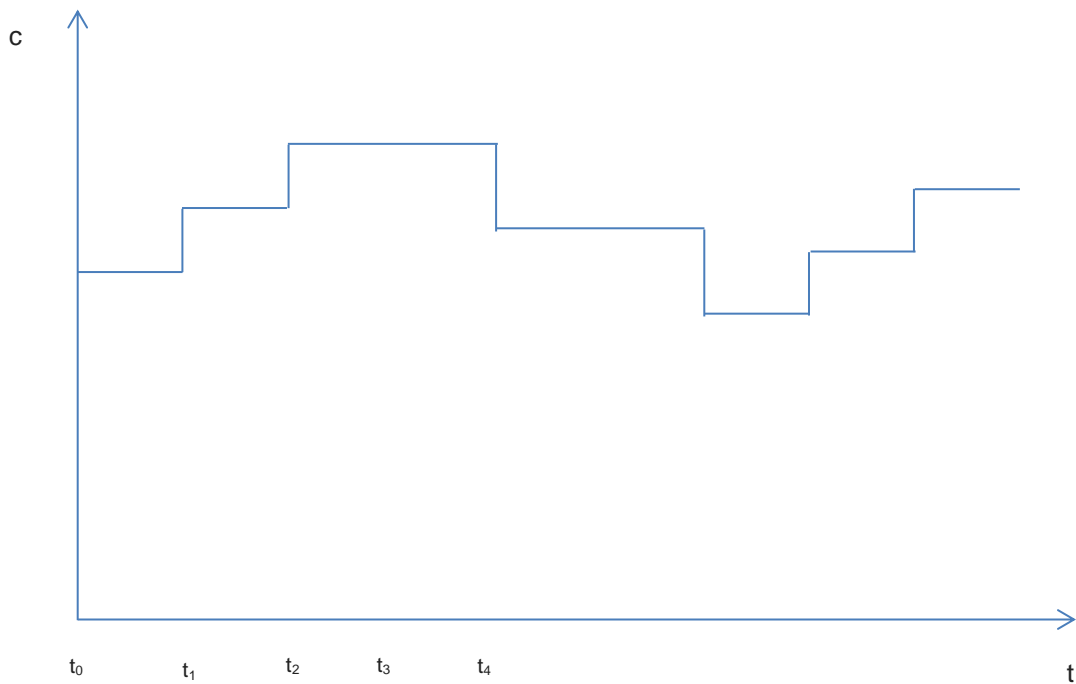

Figure 4: Typical realised consumption path for a forgetful sophisticated consumer who satisfies Assumption 1.

Inspecting Figure 4 we see can infer that, the consumer, after choosing his initial consumption level at time  $t_0$ , remembers at time  $t_1$ . This is ‘good news’ and leads to an upward revision in consumption. He again remembers at time  $t_2$ , this again leads to an upward revision in consumption. At time  $t_3$ , consumption is not revised, leading us infer that he has forgotten at that time; forgetting at time  $t_3$  guarantees that the consumer will remember for sure at time  $t_4$ . Since the consumer is following the one-period rule, when he remembers at time  $t_4$  he will notice that his assets have fallen due to being fined at time  $t_3$ . This leads to a downward revision in consumption. And so on.

The consumer’s behaviour seems to closely follow that found in Hall (1978). Hall’s classic paper argues that consumption behaviour should be unpredictable, and in particular follow a random walk.<sup>33</sup> This is because the consumer is constantly trying to satisfy his Euler equation in expectation. New information leads to innovations in consumption as the consumer updates his

---

<sup>33</sup> If  $r \neq 0$ , then a random walk with drift.

consumption. In our model, we can see the same thing, except that in some time-periods the consumer is unable to update his consumption. In the case of the one-period rule, two sequential periods of remembering is ‘good news’ and leads to a positive innovation in consumption while forgetting followed by remembering is ‘bad news’ and leads to a negative innovation in consumption.

In Section 2.2 we argued that it was possible that the consumer’s consumption profile could be increasing in spite of incurring fines. Here, we ask the following question: (in the absence of Assumption 1) if the consumer is following the one-period rule, under what conditions (if at all) will consumption be monotonically increasing over time regardless of whether the consumer remembers or not? The next result provides the answer:

**Result 3:**  $\tilde{c}'' > c' > c$  if and only if  $F < rk - c(1 + r)$  and  $c < \frac{rk}{1+r}$ .

**Proof:** First we note that consumption choice in these states is going to be an increasing function of total assets at that time. The stationary nature of the problem means that  $\tilde{c}'' > c' \Leftrightarrow \tilde{k}'' > k'$ . We consider under what conditions it will be the case that  $\tilde{k}'' > k'$ :

Since  $\tilde{k}'' = (1 + r)(k' - c - F)$ , we have that

$$\begin{aligned}\tilde{k}'' > k' &\Leftrightarrow (1 + r)(k' - c - F) > k' \\ &\Leftrightarrow rk' > (1 + r)(c + F)\end{aligned}$$

Since,  $k' = (1 + r)(k - c)$  we have that

$$\begin{aligned}\tilde{k}'' > k' &\Leftrightarrow r(1 + r)(k - c) > (1 + r)(c + F) \\ &\Leftrightarrow F < rk - c(1 + r)\end{aligned}\tag{4}$$

Now we have to show under what conditions  $c' > c$ . The stationary nature of the problem means that  $c' > c \Leftrightarrow k' > k$ . From (3) we know that

$$k' > k \Leftrightarrow c < \frac{rk}{1+r}$$

■

From this we learn that if the fine is sufficiently small, it is potentially possible to have an increasing consumption profile despite the negative impact of the penalties. This is because the consumer's assets grow even if he is fined. As we have already seen in Result 2, in the case where the consumer ideally would like to perfectly consumption smooth however (Assumption 1 holds), it must be that  $c' > \tilde{c}''$ . This is because such a consumer would never choose a consumption path that allows their assets to increase even if they are fined. Their preference for smooth consumption means that they could do better by rearranging their consumption so that more is consumed now rather than later. We can see this clearly if we rearrange (4) to get that

$$F < rk - c(1+r) \Leftrightarrow c < \frac{rk - F}{1+r}.$$

This will never be true since the RHS is the most pessimistic consumption per period that the consumer could sustain indefinitely (it could even be negative). That is, even if the consumer was fined for sure in each and every time period, they could sustain a consumption stream equal to the RHS. A similar argument means that a consumer who is impatient, and in the baseline case would choose a decreasing consumption profile, will also not satisfy the inequalities in Result 3. We conclude that in order for it to be a possibility for a consumer following the one-period rule to have monotonically increasing consumption in the restricted model, we must have that (i) he is relatively patient, and (ii) the fine from going overdrawn is relatively small.



The adjusted Euler equation on its own does not fully characterise the optimal consumption stream. We know from the baseline case that we need to use the Euler equation in conjunction with the intertemporal budget constraint in order to characterise optimal consumption choice. We now characterise the expected budget constraint facing a consumer following the one-period rule. For simplicity we continue to ignore the possibility of bankruptcy.

*Adjusting the Budget Constraint*

We know that in the baseline case the correct intertemporal budget constraint is

$$\sum_{t=0}^{\infty} \frac{c_t}{(1+r)^t} = A_0.$$

However, when the consumer follows the one-period rule, his budget constraint must be adjusted to take into account the fact that he will be fined in future with some probability. We now calculate the expected fine from following such a strategy in our restricted model.

**Result 4:** *The expected discounted value of fines paid by a consumer following the one-period rule is equal to*

$$\frac{(1-p)\delta F}{2-p} \left[ \frac{1}{1-\delta} + \frac{1-p}{1+\delta(1-p)} \right].$$

**Proof:** The diagram below shows how the consumer moves through the two states over time

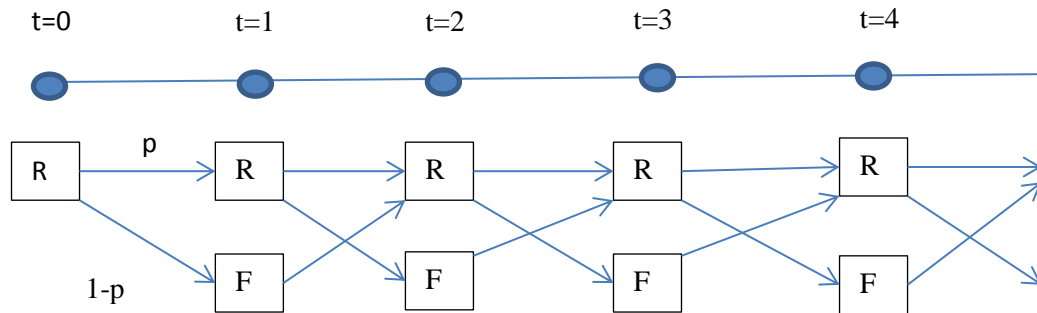

Figure 5: How the consumer moves through the two states over time.

That is, at  $t = 0$ , he is in the remember (R) state. With probability  $p$  he remains in state R in period 1, however, with probability  $1 - p$  he enters the forget (F) state. If he enters state F in period 1, this means that he will remember for sure in period 2. The arrows in Figure 5 represent possible changes in state from one period to the next.

Let  $r_t = \Pr[\text{Consumer will forget in period } t]$

And  $f_t = \Pr[\text{Consumer will forget in period } t]$

The expected discounted value of total fines paid by the consumer is given by

$$E[\text{fines}] = (\delta f_1 + \delta^2 f_2 + \delta^3 f_3 + \dots)F = F \sum_{t=1}^{\infty} \delta^t f_t$$

This is the object we are trying to find. Notice that there is a recursive relationship linking  $r$  and  $f$  over time:

$$r_t = pr_{t-1} + f_{t-1}$$

$$f_t = (1 - p)r_{t-1}$$

Writing this in matrix form

$$\begin{aligned} \begin{bmatrix} r_t \\ f_t \end{bmatrix} &= \begin{bmatrix} p & 1 \\ 1-p & 0 \end{bmatrix} \begin{bmatrix} r_{t-1} \\ f_{t-1} \end{bmatrix} \\ \Rightarrow \begin{bmatrix} r_t \\ f_t \end{bmatrix} &= \begin{bmatrix} p & 1 \\ 1-p & 0 \end{bmatrix}^t \begin{bmatrix} r_0 \\ f_0 \end{bmatrix} \end{aligned}$$

Let  $A = \begin{bmatrix} p & 1 \\ 1-p & 0 \end{bmatrix}$ . In order to find  $A^t$  we need to diagonalise  $A$  by finding its eigenvalues and eigenvectors.  $A$  has eigenvalues

$$\lambda_1 = 1, \quad \lambda_2 = -(1-p)$$

With corresponding eigenvectors

$$v_1 = \begin{bmatrix} -\frac{1}{1-p} \\ -1 \end{bmatrix}, \quad v_2 = \begin{bmatrix} 1 \\ -1 \end{bmatrix}$$

Giving us the matrix of eigenvectors  $P$  and the diagonal matrix of eigenvalues  $D$

$$P = \begin{bmatrix} -\frac{1}{1-p} & 1 \\ -1 & -1 \end{bmatrix}, \quad D = \begin{bmatrix} 1 & 0 \\ 0 & -(1-p) \end{bmatrix}$$

We can now write

$$\begin{aligned} A &= \begin{bmatrix} -\frac{1}{1-p} & 1 \\ -1 & -1 \end{bmatrix} \begin{bmatrix} 1 & 0 \\ 0 & -(1-p) \end{bmatrix} \begin{bmatrix} -\frac{1}{1-p} & 1 \\ -1 & -1 \end{bmatrix}^{-1} \\ \therefore \begin{bmatrix} r_t \\ f_t \end{bmatrix} &= \begin{bmatrix} -\frac{1}{1-p} & 1 \\ -1 & -1 \end{bmatrix} \begin{bmatrix} 1 & 0 \\ 0 & (p-1)^t \end{bmatrix} \begin{bmatrix} -\frac{1}{1-p} & 1 \\ -1 & -1 \end{bmatrix}^{-1} \begin{bmatrix} r_0 \\ f_0 \end{bmatrix} \\ \Rightarrow \begin{bmatrix} r_t \\ f_t \end{bmatrix} &= \left( \frac{1-p}{2-p} \right) \begin{bmatrix} \frac{1}{1-p} + (p-1)^t & \frac{1}{1-p} + (p-1)^{t-1} \\ 1 - (p-1)^t & 1 - (p-1)^{t-1} \end{bmatrix} \begin{bmatrix} r_0 \\ f_0 \end{bmatrix} \end{aligned}$$

By assumption,  $t = 0$  is a time period where the consumer remembers and creates a plan.

Giving us the initial conditions that  $r_0 = 1$  and  $f_0 = 0$ . This yields us that

$$r_t = \frac{1 - (p - 1)^{t+1}}{2 - p}, \quad f_t = \frac{1 - p + (p - 1)^{t+1}}{2 - p}$$

Now we can explicitly calculate expected discounted fines

$$\begin{aligned} E[\text{fines}] &= F \sum_{t=1}^{\infty} \delta^t f_t \\ &= F \sum_{t=1}^{\infty} \delta^t \left[ \frac{1 - p + (p - 1)^{t+1}}{2 - p} \right] \\ &= \frac{F}{2 - p} \sum_{t=1}^{\infty} \delta^t [1 - p + (p - 1)^{t+1}] \\ &= \frac{F}{2 - p} \left[ (1 - p) \sum_{t=1}^{\infty} \delta^t + \sum_{t=1}^{\infty} \delta^t (p - 1)^{t+1} \right] \\ &= \frac{F}{2 - p} \left[ \frac{(1 - p)\delta}{1 - \delta} + \frac{\delta(p - 1)^2}{1 - \delta(p - 1)} \right] \\ &= \frac{(1 - p)\delta F}{2 - p} \left[ \frac{1}{1 - \delta} + \frac{1 - p}{1 + \delta(1 - p)} \right] \end{aligned}$$

■

So, the adjusted ex-ante budget constraint for this problem is

$$E \left[ \sum_{t=0}^{\infty} \frac{c_t}{(1 + r)^t} \right] + \frac{(1 - p)\delta F}{2 - p} \left[ \frac{1}{1 - \delta} + \frac{1 - p}{1 + \delta(1 - p)} \right] = A_0$$

That is, on the LHS we have the total expected discounted liabilities (consumption plus fines), and on the RHS we have total assets. To reiterate, this is only the expected budget constraint, in reality the DM faces a sequence of budget constraints whose evolution depends on the evolution of memory events. This budget constraint is then, only an approximation of the dynamic constraints that the DM faces. Nonetheless, it makes sense that in expectation the DM's liabilities must not exceed his assets when he makes a choice.

### 3.2 TWO-PERIOD RULE

In this case, whenever the consumer remembers he always allocates two-periods of consumption to his current account. This means that he will never become overdrawn and never be fined. There will be an opportunity cost of losing out on the returns from holding an additional period of consumption in the current account. In contrast to the ‘one-period rule’ above, here there is no longer an equivalence between total assets at the start of a time period ( $A_t$ ) and the amount of funds in the savings account at that time ( $k_t$ ). Thus the correct state variable for the dynamic problem will be  $A_t$ .

**Result 5:** *When following the two-period rule, the consumer’s optimal choice satisfies the adjusted Euler equation:*

$$\frac{u'(c)}{pu'(c') + (1-p)(1+r)\delta u'(\tilde{c}'')} = (1+r)\delta$$

**Proof:** The value function for the problem satisfies:

$$V^R(A) = \max_c u(c) + p\delta V^R(A') + (1-p)\delta V^F(A')$$

Where  $A' = (1+r)(A-2c) + c$ , that is, if he starts with assets  $A$  and follows the two-period rule he will have  $A-2c$  in his savings account, which will become  $(1+r)(A-2c)$  tomorrow. To find total assets tomorrow we have to add the remaining balance in his current account,  $c$ . And where  $V^F(A') = u(c) + \delta V^R((1+r)(A'-c))$ . That is, if he forgets tomorrow then he consumes according to his consumption choice today,  $c$ . Furthermore, he will remember for sure the day after when the balance of his savings account will be  $(1+r)(A'-c)$  and he will have exhausted the balance of his current account.

Rewriting, we have that

$$V^R(A) = \max_{A'} (1 + (1 - p)\delta)u\left(\frac{(1 + r)A - A'}{1 + 2r}\right) + p\delta V^R(A') + (1 - p)\delta^2 V^R((1 + r)(A' - c))$$

Taking first order and envelope conditions:

$$\frac{1 + (1 - p)\delta}{1 + 2r}u'(c) = p\delta V^{R'}(A') + (1 + r)(1 - p)\delta^2 V^{R'}(\tilde{A}'')$$

Where  $\tilde{A}'' = (1 + r)(A' - c)$

$$V^{R'}(A) = \frac{1 + r}{1 + 2r}(1 + (1 - p)\delta)u'(c)$$

Combining these gives

$$\frac{u'(c)}{pu'(c') + (1 - p)(1 + r)\delta u'(\tilde{c}'')} = (1 + r)\delta$$

■

Notice that this is exactly the same optimality condition as in the one-period rule case. On the one hand this should perhaps not be surprising since implicit in our analysis is that our consumer is an expected utility maximiser, so an optimality condition which can be expressed as an expected Euler equation is not unusual. On the other hand, we might be surprised, since, as we have previously argued, what we call the one-period and two-period rule may not be globally optimal strategies. The fact that the consumer can satisfy an analogous Euler equation to the baseline case makes us think that perhaps we have not lost much by this more restrictive model. Furthermore, the consumer in our model has bounded control i.e. she is not able to reoptimise in each period – she can only do so in periods where she remembers. Nevertheless it is clear that when the consumer has memory imperfections her welfare will necessarily be reduced

compared to the baseline case. This is true whether she follows the one-period or two-period rule. By following the one-period rule she leaves herself open to being fined every time she forgets. While following the two-period rule means that she is not earning as much returns on her savings as she would if she did not have memory imperfections. Having characterised the two rules the question arises as to whether the consumer is better off following one or the other.

*Dominance*

**Result 6:** *The one-period rule dominates the two-period rule if and only if  $F < cr$ .*

**Proof:** Imagine the consumer begins with assets  $A$  and follows the one-period rule, his total assets tomorrow (which is the relevant state variable when he remembers tomorrow) will be  $(1 + r)(A - c)$ . If he forgets tomorrow, his total assets on the next day (which is the relevant state variable when he forgets tomorrow) will be  $(1 + r)((1 + r)(A - c) - c - F)$ . In contrast, if he follows the two-period rule, his total assets tomorrow will be  $(1 + r)(A - 2c) + c$  and if he forgets tomorrow then his assets the day after will be  $(1 + r)^2(A - 2c)$ . The table below provides a summary:

	$A'$	$\tilde{A}''$
One-period Rule	$(1 + r)(A - c)$	$(1 + r)((1 + r)(A - c) - c - F)$
Two-period Rule	$(1 + r)(A - 2c) + c$	$(1 + r)^2(A - 2c)$

**Figure 6:** Comparing asset positions under the two rules.

Since we are making a dominance argument, suppose that the level of consumption today,  $c$ , chosen is the same regardless of which strategy is being followed. Then it is clear that in the

state of the world where he remembers tomorrow, he is better off following one-period rule, since:

$$(1 + r)(A - c) > (1 + r)(A - 2c) + c$$

This makes sense, if the DM remembers tomorrow then there is no value to having the extra ‘insurance’ that two-period rule provides. Rather he prefers the one-period rule as it maximises his returns from his savings. Making a similar comparison in the case that he forgets tomorrow (and remembers for sure the day after), we see that:

$$\tilde{A}''_{1PR} > \tilde{A}''_{2PR}$$

$$\Leftrightarrow (1 + r)((1 + r)(A - c) - c - F) > (1 + r)^2(A - 2c)$$

This comes from substituting the values found in Figure 6. Simplifying, we have

$$\tilde{A}''_{1PR} > \tilde{A}''_{2PR} \Leftrightarrow (1 + r)(A - c) - c - F > (1 + r)(A - 2c)$$

$$\Leftrightarrow -c - F > -(1 + r)c$$

$$\Leftrightarrow cr > F$$

■

That is, if  $F < cr$ , the one-period rule dominates the two-period rule, since in this case the fine is so small that you are better off saving the additional unit of consumption in the savings account since the additional return will more than offset the fine. Dominance is quite a demanding test. What might be more interesting is when one rule does better than another in expectation. To find an answer to this we need to calculate what happens to the budget constraint when the consumer follows the two-period rule. As we have argued previously, he will never be fined but he will not be able to save optimally, thus reducing the value of his ‘effective assets’.



*Adjusting the budget constraint*

The general principle is that losing the life-time of returns which accrue from to saving an amount  $c > 0$  today is the same as losing amount  $c$  today. What I mean by this is that the value of having assets  $A$  today must be equal to the NPV of the lifetime returns which accrue from saving those assets forever. If this were not the case then there would be arbitrage opportunities. That is, it must be the case that

$$A = \sum_{t=1}^{\infty} \frac{rA}{(1+r)^t}$$

Similarly, if the DM has assets  $A$  today but he is not able to make use of those assets optimally then effectively those assets are not worth  $A$  to him, rather, they must be adjusted downward by the expected discounted loss of returns.

**Result 7:** *The discounted expected loss of returns from following the two-period rule is equal to*

$$\frac{\delta rc}{2-p} \left[ \frac{1}{1-\delta} + \frac{1-p}{1+\delta(1-p)} \right].$$

**Proof:** By following the two-period rule the DM will definitely miss out on one-period worth of returns tomorrow ( $t = 1$ ) worth  $rc$ . Whether he loses  $rc$  the period after ( $t = 2$ ) depends upon whether he was in the Remember or Forget state in period 1. If he was in the remember state, then he will have readjusted his holdings so that he would again have two-periods of consumption in his current account, and thus his savings would have been suboptimal. If he was in the forget state in period 1, his savings will actually be optimal since he will only be holding one-period of consumption in his current account to fund period-two consumption. In general, if he remembers at time  $t$ , he will have too much funds in his current account which will mean that he loses out on returns of  $rc$  at time  $t+1$ . However, if he forgets at time  $t$ , he will only have just enough funds in his current account to fund period  $t+1$  consumption. This analysis tell us that

$$E[\text{discounted loss}] = \delta rc + \delta^2 rcr_1 + \delta^3 rcr_2 + \dots$$

$$= rc[\delta + \delta^2 r_1 + \delta^3 r_2 + \dots]$$

$$= rc \sum_{t=1}^{\infty} \delta^t r_{t-1}.$$

We found earlier that  $r_t = \frac{1-(p-1)^{t+1}}{2-p}$ , which gives us that

$$\begin{aligned} E[\text{loss}] &= rc \sum_{t=1}^{\infty} \delta^t \left[ \frac{1-(p-1)^t}{2-p} \right] \\ &= \frac{rc}{2-p} \sum_{t=1}^{\infty} \delta^t [1-(p-1)^t] \\ &= \frac{rc}{2-p} \left[ \sum_{t=1}^{\infty} \delta^t - \sum_{t=1}^{\infty} \delta^t (p-1)^t \right] \\ &= \frac{rc}{2-p} \left[ \frac{\delta}{1-\delta} - \frac{\delta(p-1)}{1-\delta(p-1)} \right] \\ &= \frac{\delta rc}{2-p} \left[ \frac{1}{1-\delta} + \frac{1-p}{1+\delta(1-p)} \right] \end{aligned}$$

■

The adjusted budget constraint for the problem is

$$E \left[ \sum_{t=0}^{\infty} \frac{c_t}{(1+r)^t} \right] = A_0 - \frac{\delta rc}{2-p} \left[ \frac{1}{1-\delta} + \frac{1-p}{1+\delta(1-p)} \right]$$

That is, inspecting the RHS we see that his initial assets have been downwardly revised to take into account that he is not able to utilise his assets optimally, in the sense of earning a return on his savings. Now that we know the adjusted budget constraints for both the one-period and two-period rule we can state our final result.

**Result 8:** *In expectation, the one-period rule does better than the two-period rule if and only if  $rc > (1-p)F$ .*

**Proof:** Notice that both the one-period rule and two-period rule have the same Euler equation. Furthermore, the budget constraints are very similar except that they differ by the downward adjustment which is made. In the one-period rule we adjust for fines and in the two-period rule we adjust for suboptimal savings. Thus in order to work out when the consumer is better off in expectation we only need to compare the adjustment terms, that is

$$\begin{aligned}
 & u_{1PR} > u_{2PR} \\
 \Leftrightarrow & \frac{\delta rc}{2-p} \left[ \frac{1}{1-\delta} + \frac{1-p}{1+\delta(1-p)} \right] > \frac{(1-p)\delta F}{2-p} \left[ \frac{1}{1-\delta} + \frac{1-p}{1+\delta(1-p)} \right] \\
 \Leftrightarrow & rc > (1-p)F
 \end{aligned}$$

■

That is, whether the one-period rule or two-period rule does better in expectation depends on whether the additional returns from holding one more period of consumption in the savings account is sufficient to cover the expected loss from being fined tomorrow. This is a very simple and intuitive decision rule for the consumer to follow. Essentially it follows from the fact that we are looking at average behaviour and this rule tells us that average performance is what matters.

## 4 CONCLUDING REMARKS

Analysing the consumption behaviour of a forgetful decision maker is an interesting problem. Unfortunately, it is also a difficult problem to solve. This is not surprising as the consumer in our model sometimes optimises and at other times forgets to do so. In this chapter we have introduced the problem and attempted to solve it. However, in order to make progress, some strong simplifying assumptions were made. In particular, the memory process was restricted; we only considered two simple strategies; and we used a single expected budget constraint. Relaxing these could be an avenue for future research. Nevertheless, the model presented here is a good example of a decision problem where there is a natural default action in the case that the DM forgets i.e. he does not transfer any funds and consumes according to some default plan. This

has allowed us to analyse the problem using only the standard tools of game theory for decision makers who have perfect recall.

## REFERENCES

- Alvarez, F., Guiso, L., and Lippi, F. (2012). "Durable Consumption and Asset Management with Transaction and Observation Costs," *American Economic Review* 102(5): 2272-2300.
- Ameriks, J., Caplin, A., and Leahy, J. (2004). "The Absent-Minded Consumer," *NBER Working Paper* 10216.
- Armstrong, M., and Zhou, J. (2011). "Paying for Prominence," *Economic Journal* 121(556): 368-395.
- Aumann, R., Hart, S., and Perry, M. (1997). "The Absent-Minded Driver," *Games Econ. Behav.* 20: 102-116.
- Battigalli, P. (1997). "Dynamic Consistency and Imperfect Recall," *Games Econ. Behav.* 20: 31-50.
- Baye, M. R., and Morgan, J. (1999). "A folk theorem for one-shot Bertrand games," *Economics Letters* 65(1): 59-65.
- Baye, M. R., and Morgan, J. (2000). "A Simple Model of Advertising and Subscription Fees," *Economics Letters* 69(3): 345-51.
- Baye, M. R., and Morgan, J. (2001). "Information Gatekeepers on the Internet and the Competitiveness of Homogeneous Product Markets," *American Economic Review* 91(3): 454-474.
- Baye, M. R., Gao, X., and Morgan, J. (2011). "On the Optimality of Clickthrough Fees in Online Markets," *Economic Journal* 121(556): 340-367.
- Beckman, M. (1965). "Bertrand-Edgeworth duopoly revisited," in *Operations-Research Verfahren* (ed. R. Henn), 3: 55-68.
- Bernheim, B. D. (1984). "Rationalizable Strategic Behavior," *Econometrica* 52(4): 1007-28.
- Bernheim, B. D., and Thomadsen, R. (2005). "Memory and Anticipation," *The Economic Journal* 115: 271-304.
- Bertrand, J. (1883). "Book review of *theorie mathematique de la richesse sociale* and of *recherches sur les principes mathematiques de la theorie des richesses*," *Journal de Savants* 67: 499-508.
- Bonanno, G. (2004). "Memory and perfect recall in extensive games," *Games Econ. Behav.* 47: 237-256.
- Brown, G.W. (1951). "Iterative Solution of Games by Fictitious Play," in *Activity Analysis of Production and Allocation*. New York: Wiley.
- Burdett, K., and Judd, K. (1983). "Equilibrium price dispersion," *Econometrica* 51(4): 955-969.
- Chen, Y. and He, C. (2011), "Paid Placement: Advertising and Search on the Internet," *Economic Journal* 121: 309-328.
- Cournot, A. (1838). "Researches into the Mathematical Principles of the Theory of Wealth," Trans. N.T. Bacon, New York: Macmillan, 1929.

- DellaVigna, S., and Malmendier, U. (2004). "Contract Design and Self-Control: Theory and Evidence," *Quarterly Journal of Economics* 119(2): 353–402.
- Diamond, P. (1971). "A model of price adjustment," *Journal of Economic Theory* 3(2): 156-168.
- Diamond, P. (1987). "Search theory," in *The New Palgrave Dictionary of Economics*, ed. J. Eatwell, M. Milgate and P. Newman. London: Macmillan.
- Dixon, H. D. (1992). "The Competitive Outcome as the Equilibrium in an Edgeworthian Price-Quantity Model," *The Economic Journal* 102(411): 301-309.
- Dow, J. (1991). "Search Decisions with Limited Memory," *Review of Economic Studies* 58(1): 1-14.
- Edgeworth, F. Y. (1925). "Papers relating to political economy," 3 vols. Available online at Gallica.
- Eliasz, K., and Spiegel, R. (2006). "Contracting with Diversely Naive Agents," *Review of Economic Studies* 73(3): 689-714.
- Eliasz, K. and Spiegel, R. (2011). "A Simple Model of Search Engine Pricing," *Economic Journal* 121: 329–339.
- Ellison, G., and Ellison, S. F. (2005). "Lessons About Markets from the Internet," *Journal of Economic Perspectives* 19(2): 139-158.
- Esteban, S., and Miyagawa, E. (2006). "Temptation, self-control, and competitive nonlinear pricing," *Economics Letters* 90(3): 348-355.
- Fudenberg, D., and Levine, D. K. (1998). "The Theory of Learning in Games," The MIT Press.
- Gilboa, I. (1997). "A Comment on the Absent Minded Driver Paradox," *Games Econ. Behav.* 20: 25-30.
- Grove, A., and Halpern, J. (1997). "On the Expected Value of Games with Absentmindedness," *Games Econ. Behav.* 20: 51-65.
- Hall, R. (1978). "Stochastic Implications of the Life Cycle-Permanent Income Hypothesis: Theory and Evidence," *Journal of Political Economy* 86(6): 971–987.
- Halpern, J. (1997). "On Ambiguities in the Interpretation of Games Trees," *Games Econ. Behav.* 20: 66-96.
- Hofbauer, J. and Sandholm, W. H. (2002). "On the Global Convergence of Stochastic Fictitious Play," *Econometrica* 70: 2265–2294.
- Kline, J. J. (2002). "Minimum Memory for Equivalence between Ex Ante Optimality and Time-Consistency," *Games Econ. Behav.* 38: 278-305.
- Kreps, D. M., and Scheinkman, J. A. (1983). "Quantity Precommitment and Bertrand Competition Yield Cournot Outcomes," *Bell Journal of Economics* 14(2): 326-337.
- Kuhn, H. W. (1953). "Extensive games and the problem of information," in: H. W. Kuhn and W. W. Tucker (eds.), *Contributions to the theory of games*, Vol. II, Princeton University Press, 193-216.

- Levin, J. D. (2011). "The Economics of Internet Markets," *NBER Working Paper* 16852.
- Levitan, R., and Shubik, M. (1972). "Price Duopoly and Capacity Constraints," *International Economic Review* 13(1): 111-122.
- Lipman, B. (1997). "More Absentmindedness," *Games Econ. Behav.* 20: 97-101.
- Maskin, E., and Tirole, J. (1988). "A Theory of Dynamic Oligopoly II: Price Competition, Kinked Demand Curves and Edgeworth Cycles," *Econometrica* 56(3): 571-99.
- Mintel (2011). "Web Aggregators in Financial Services."
- Mortensen, D., and Pissarides, C. (1994). "Job creation and job destruction in the theory of unemployment," *Review of Economic Studies* 61(3): 397-415.
- Mullainathan, S. (2002). "A Memory-Based Model of Bounded Rationality," *The Quarterly Journal of Economics* 117(3): 735-774.
- von Neumann, J. and Morgenstern, O. (1944). "Theory of Games and Economic Behavior," Princeton University Press.
- O'Donoghue, T., and Rabin, M. (2001). "Choice And Procrastination," *The Quarterly Journal of Economics* 116(1): 121-160.
- Pearce, D. (1984). "Rationalizable Strategic Behavior and the Problem of Perfection," *Econometrica* 52: 1029-1050.
- Peters, M. (1991). "Ex ante price offers in matching games: non-steady state," *Econometrica* 59: 1425-54.
- Piccione, M., and Rubinstein, A. (1997). "On the Interpretation of Decision Problems with Imperfect Recall," *Games Econ. Behav.* 20: 3-24.
- Reis, R. (2006). "Inattentive consumers," *Journal of Monetary Economics* 53(8): 1761-1800.
- Rothschild, M. (1974). "Searching for the lowest price when the distribution is not known," *Journal of Political Economy* 82: 689-711.
- Rubinstein, A. (1998). "Modelling bounded rationality," MIT Press.
- Sabourian, H. (1998). "Repeated games with M-period bounded memory," *Journal of Mathematical Economics* 30(1): 1-35.
- Sarafidis, Y. (2007). "What Have you Done for me Lately? Release of Information and Strategic Manipulation of Memories," *The Economic Journal* 117: 307-326.
- Sarin, R. (2000). "Decision Rules with Bounded Memory," *Journal of Economic Theory* 90: 151-160.
- Selten, R. (1975). "Re-examination of the Perfectness Concept for Equilibrium Points in Extensive Games," *International Journal of Game Theory* 4(1): 25-55.
- Shapley, L.S. (1964). "Some topics in two-person games," in *Advances in Game Theory*, ed. M. Dresher, L.S. Shapley, and A.W. Tucker, Princeton University Press.

- Shi, S. (2008). "search theory (new perspectives)," *The New Palgrave Dictionary of Economics*. Second Edition. Eds. Steven N. Durlauf and Lawrence E. Blume. Palgrave Macmillan.
- Sims, C.A. (2003). "Implications of Rational Inattention," *Journal of Monetary Economics* 50(3): 665-690.
- Sims, C.A. (2006). "Rational Inattention: Beyond the Linear-Quadratic Case," *American Economic Review Papers and Proceedings* 96(2): 158-163.
- Spiegler, R. (2006). "Competition over agents with boundedly rational expectations," *Theoretical Economics* 1(2): 207-231.
- Spiegler, R. (2011). "Bounded Rationality and Industrial Organization," Oxford University Press.
- Stigler, G. J. (1961). "The economics of information," *Journal of Political Economy* 69(3): 213–225.
- Stigler, G. J. (1962). "Information in the labor market," *Journal of Political Economy* 70(5): 94–105.
- Varian, H. R. (1980). "A Model of Sales," *American Economic Review* 70(4): 651-659.