

11

Evaluating and Expanding Hillier's Mean Local Choice:

The Need for a New Measure of Quantitative Spatial Description

Chenyang Li

Space Syntax Laboratory, Bartlett School of Architecture, UCL
chenyang.li@ucl.ac.uk

Sophia Psarra

Space Syntax Laboratory, Bartlett School of Architecture, UCL
s.psarra@ucl.ac.uk

Sean Hanna

Space Syntax Laboratory, Bartlett School of Architecture, UCL
s.hanna@ucl.ac.uk

ABSTRACT

This paper critically evaluates the 'mean local choice', a newly introduced spatial measurement by Hillier in his keynote speech presented in Beijing (2019). Different from the well-discussed mathematical 'betweenness centrality' in syntactic studies, Hillier's proposed measure looks at the step-by-step alternatives (choices) regarding the all-to-all visit from each space in a spatial environment to all others by the simplest route. He argues that different levels of mean local choice values entail 'consequent functional effects on spatial layout' (Hillier, 2019, p.14). This paper identifies methodological deficits in Hillier's explanations, arguing that the calculations of mean local choice in different structure types are not mathematically consistent. Moreover, the social significance stemming from differential functional effects varied by mean local choice in spatial layouts remains undefined, limiting the theoretical and practical applicability of this new measure. Building on this observation, this paper provides two possible evaluations of the theoretical definition of mean local choice, deriving from Hillier's original work. Comparing this measure with the measures of 'betweenness centrality' and syntactic choice, it raises the following questions: How does mean local choice differ from existing spatial measures? How do varying levels of mean local choice correspond to diverse functional effects in spatial layouts? We argue that mean local choice, as an independent spatial variable, provides a new perspective on the

relationship between spatial attributes and human behavioural patterns. Furthermore, this paper introduces a third approach to defining and calculating mean local choice, diverging from Hillier's original methods. We suggest that this approach more accurately captures the theoretical essence of the new measure. Consequently, we provide comprehensive evaluations of mean local choice for theoretical models with different node counts and present a Python-based program designed for analysing real-world configurations, which enables the practical application of mean local choice, enhancing its utility in spatial analysis.

KEYWORDS

Local choice, spatial structure, spatial configuration, social signification, space syntax.

1 INTRODUCTION

'Another difference between the forms, though this time one not represented in existing syntactic analysis, has to do with choice, in the practical sense of step-by-step directional alternatives (rather than mathematical 'betweenness' or syntactic choice) ... We can call this measure 'mean local choice', and note its radically different values for the four structures and the consequent functional effects on spatial layout' (Hillier 2019, p.13-14).

A key issue in the current space syntax theory is a lack of quantitative comparisons of different kind of structures, both at the building and urban scale. This issue is addressed in the last work of Bill Hillier (2019), presented as the keynote in the 12th Space Syntax Symposium. His study classifies four structure types derived from graph theory and contends that comparing these structure-types and their associated functional effects can provide an effective means of evaluating the impact of spatial layout on social functioning. The goal of Hillier's work is to provide a direction for the space syntax theory to be more testable in a broad range of design and planning projects to become a science.

In Hillier's paper, three spatial measures were proposed as key characteristics to identify and categorize the structure types: total depth, traversability, and mean local choice. While total depth is an established measure in space syntax, traversability is adapted from graph theory, originally conceptualized as Hamiltonicity. Mean local choice, distinct from the prior two measures, is a novel concept introduced and elaborated by Hillier. He suggested that the mean local choice differs from the existing syntactic choice measure, the betweenness centrality, and is essential for the quantitative description of spatial forms. Nevertheless, this paper identifies inconsistencies and mathematical inaccuracies in Hillier's calculations of mean local choice within theoretical graph structures, leaving its definition somewhat ambiguous and its practical application unclear.

In response to this observation, this paper seeks to reassess and refine the spatial measure of mean local choice, drawing upon Hillier's example experiments to develop a consistent and quantifiable measure. Furthermore, it introduces an alternative approach for calculating and interpreting mean local choice, diverging from Hillier's initial definition. The paper argues that this revised approach could add to a more theoretically robust framework, enhancing the scientific credibility of space syntax theory in the context of describing building layouts.

2 HILLIER'S THEORY OF MEAN LOCAL CHOICE

According to Hillier (2019), the mean local choice quantifies the range of choices available to individuals while following the shortest route to visit all spaces in a spatial configuration. This measure is calculated by the sum of choices across the number of steps necessary to get from one space to traverse to all others through the shortest path. Figure 1 provides an illustrative example of how Hillier computed the mean local choice of a 7-node a-structure.

Beginning at the central node (Figure 1a), there are six possible directions to move to the next node. After moving to an edge node, the only option is to return to the central node (Figure 1b). Subsequently, from the central node, there are now five viable choices, as one edge node has already been visited (Figure 1c). As the traversal continues and five edge nodes are visited, the only remaining choice is to proceed to the final unvisited edge node (Figure 1e) and complete the journey (Figure 1f). Therefore, the total number of alternatives along this route is: $6+1+5+1+4+1+3+1+2+1+1$, totalling 26. Dividing this sum by the route length, which consists of 11 steps, yields the average number of choices per step for this central node: $26/11 = 2.36$. This indicates that, on average, the central node has an average of 2.36 alternatives during its traversal to all other nodes. Using a similar approach for the edge nodes and summing the total choices divided by the total steps, the mean choice value for the entire a-graph is provided ($146/71 = 2.06$).

Hillier's calculations for the b-structure (path) and the c-structure (cycle) graphs applied the same approach. The computed results for these structures are 1.14 ($58/51$) and 1.17 ($49/42$), respectively, indicating that the mean local choice values for b- and c-structures are comparatively lower than that of the a-structure.

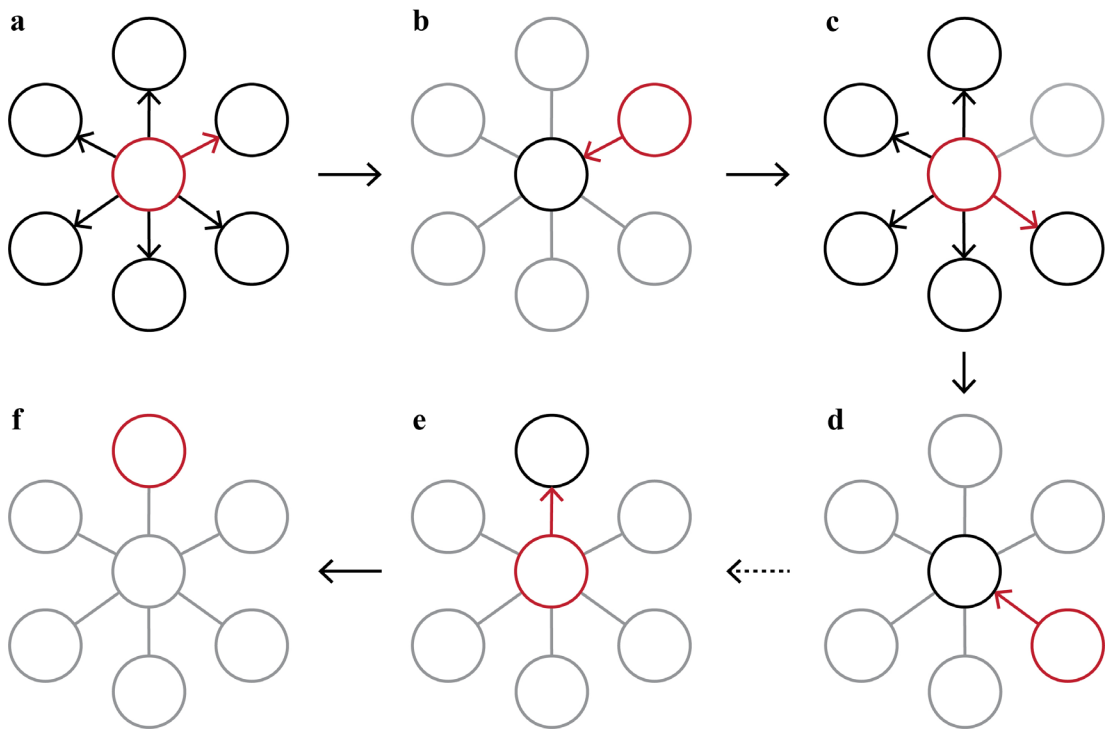

Figure 1: Hillier's example of calculating the mean local choice of a 7-node a-structure (Hillier 2019).

The calculation by Hillier of the mean local choice for the d-structure graph, as shown in Figure 2.1, exhibits inconsistencies when compared to his analyses of the other three structures. In his approach, the central node initially has six choices, followed by a consistent three choices until the end of the route, amounting to a total of 24 choices ($6+3+3+3+3+3$). By dividing this sum by 7 (the total number of steps), he computed a mean local choice value of 3.43 for this node, which is considerably higher than that of the a-structure.

The first issue in Hillier's calculation is the step count for the central node, which should be 6, not 7, as the traversal should conclude upon reaching the final node without needing to return to the start point, consistent with his approach for the other three structures. Consequently, the corrected choice count should be 21 ($6+3+3+3+3$), leading to a recalculated mean local choice of 3.5 (21 divided by 6).

The second, more critical theoretical inconsistency lies in the number of alternatives available after the first movement. For instance, as shown in Figure 2.2a, the central node (node a) has six initial directions to choose from. Once a move is made (e.g., from a to b), there should be only two options (to c or to g, as illustrated in Figure 2.2b), not three. A return move to node a is not feasible since this measure is based on the shortest traversal route. Therefore, aligning with the calculation logic used for the a-, b-, and c-structures, the central node of a 7-node d-structure graph should initially have six choices, followed by two choices at the second step, and then only one choice for each subsequent move to the final node. This results in a total of 12 choices ($6+2+1+1+1$). Dividing

by 6 (the number of steps) yields a mean local choice value of 2. This figure, while higher than the values for b- and c-structures, is significantly lower than how it was calculated by Hillier.

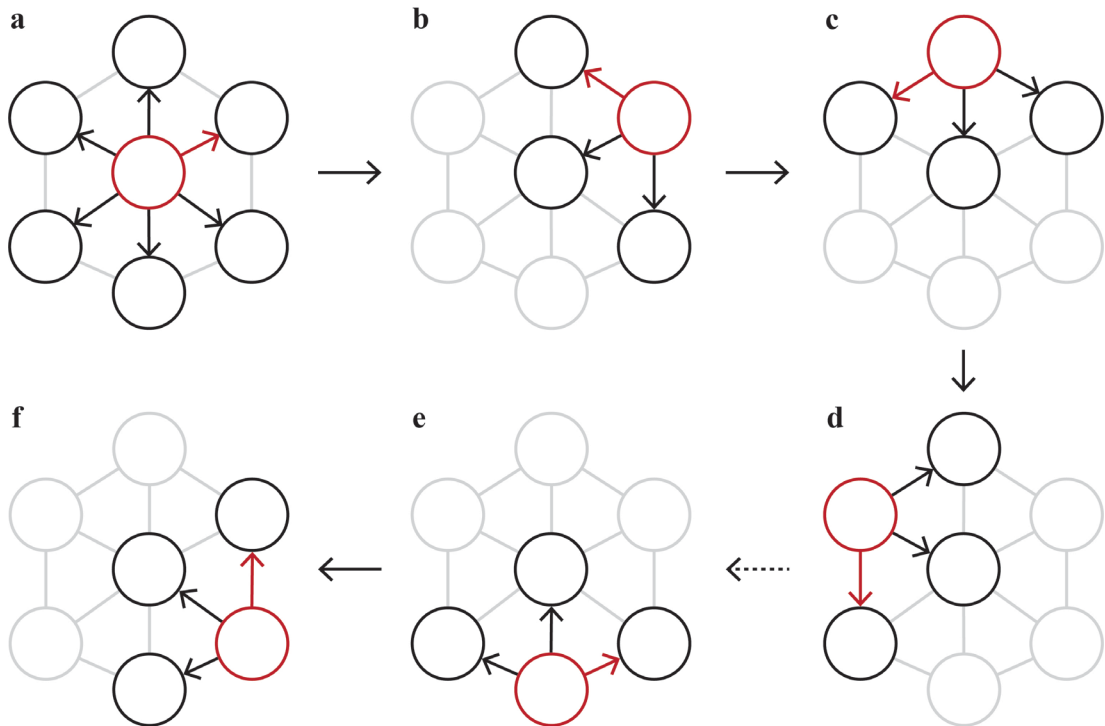

Figure 2.1: Hillier's example of calculating the mean local choice of a 7-node d-structure (Hillier 2019).

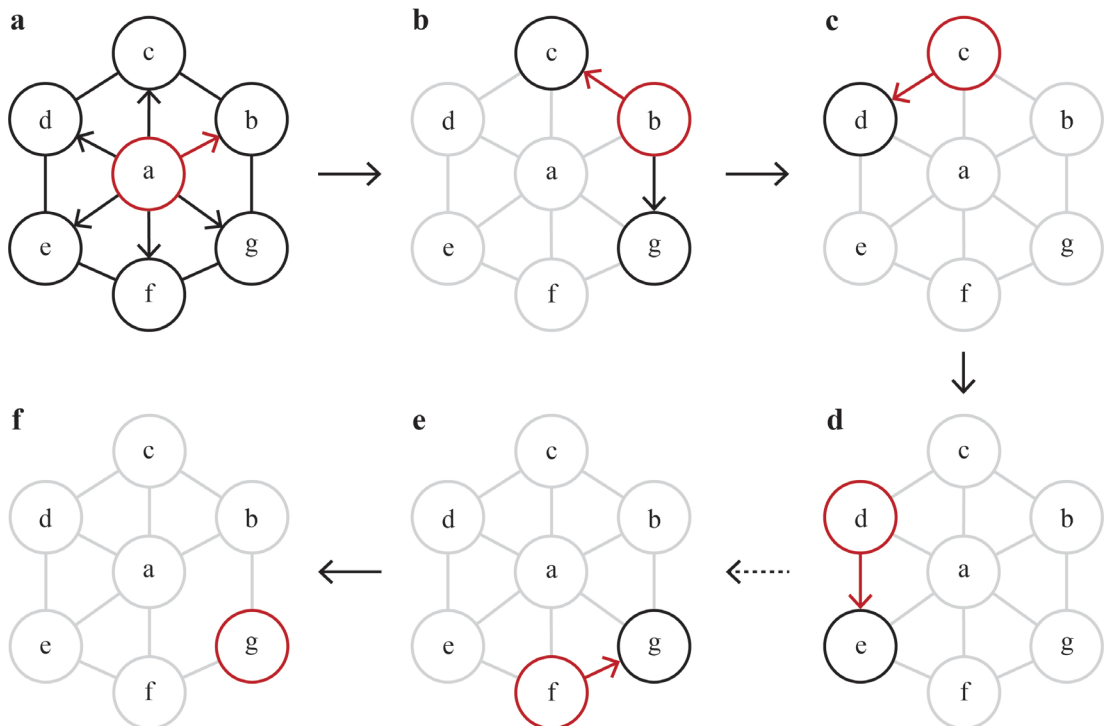

Figure 2.2: Calculating the mean local choice of a 7-node d-structure consistent with the same approach Hillier applied in the other three structures (Hillier 2019).

The redefinition of the calculation method for the d-structure has enabled us to establish a consistent approach for determining the mean choice values as outlined by Hillier. The next step, suggested by this paper, is to extend these approaches, derived from the 7-node examples, into mathematical models capable of calculating mean choice values for any given node count. However, before proceeding to this step, we must first understand the existing concept of syntactic choice, the betweenness centrality widely discussed in the space syntax field, and how this newly proposed 'mean local choice' measure differs from it.

3 SYNTACTIC CHOICE: THE BETWEENNESS CENTRALITY

Betweenness centrality, a key measure in network analysis originally introduced by Freeman (1977), evaluates the significance of a node in a network based on its occurrence on the shortest paths between other nodes. This concept has been extensively applied in various research fields, notably in social network analysis (Newman 2005; Brandes 2008; Lü et al. 2016). It was first integrated into space syntax theory by Hillier et al. in their influential 1987 paper, '*Creating Life: Or, Does Architecture Determine Anything*'. Adapting the concept of betweenness centrality, their study introduced what they termed the 'global dynamic measure', the 'choice'. This measure, suggested by Hillier et al., represents the extent to which each space in a spatial system features on all shortest paths connecting all spaces to each other. Essentially, in spatial terms, betweenness centrality equates to the probability of a space being chosen by individuals moving from one point to another within a given layout.

Hillier, Yang, and Turner (2012) offered a comprehensive mathematical elucidation of syntactic choice calculation in their study '*Normalising lease angle choice in Depthmap*'. This measure, closely related to topological depth, is assessed on an origin-destination basis. An illustrative example from their study (Figure 3), demonstrates the calculation process. Beginning at the left node (the origin), the two nodes connected to it each have a 50% possibility of being chosen by the origin on its route to the destination.

In the subsequent step, while the top node has no alternative but to continue forward, the probabilities at the bottom node are divided again amongst its two connections, resulting in one node having a 75% chance of being chosen and the other a 25% chance. This calculation is mirrored when moving in the opposite direction, from right to left. The aggregate of these probabilities represents the total likelihood of each node being chosen along this route. Evidently, nodes with a value of 1.25 have a higher probability of being selected compared to those with a value of 0.75, thereby highlighting their greater significance within the spatial network's movement flow.

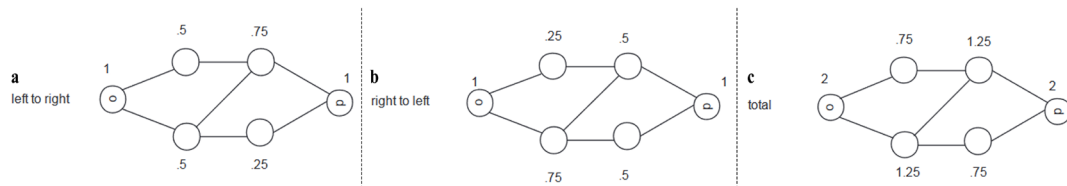

Figure 3: An example of calculating the syntactic choice (Hillier, Yang and Turner 2012).

We can now identify the theoretical distinction between mean local choice and the existing concept of syntactic choice. Syntactic choice is predicated on the shortest origin-destination routes across all nodes, whereas mean local choice is dependent on a continuous traverse route that originates from a single node and encompasses all other nodes in a single journey. Thus, mean local choice effectively quantifies the average number of choices an individual has at each step during their traversal. This metric reflects the potential for an individual to switch to alternative routes during their exploration, while simultaneously ensuring efficient navigation to cover all spaces in the shortest possible manner.

This distinction highlights that, despite both metrics incorporating the term of 'choice', they are fundamentally different. While syntactic choice assesses the significance of nodes within destination-oriented flows, mean local choice reflects the degree to which individuals are presented with options to alter their paths during exploration. This paper suggests that the inclusion of the term 'local' in 'mean local choice' is particularly apt. It captures the essence of the measure: the availability of alternative options at each step, representing local decision-making within the broader context of global navigation.

4 EVALUATIONS OF MEAN LOCAL CHOICE

This paper aims to extend the evaluation of mean local choice for the four theoretical structures (a-, b-, c-, and d-structures) from Hillier's specific node count example of seven to general equations applicable to any node count. As explained in the above section, Hillier's original explanation for calculating mean local choice presents a discontinuity: the methodologies for a-, b-, and c-structures align under one logical framework, while the approach for the d-structure diverges. To address this, our paper offers two distinct evaluations, each aligning with the different logics proposed by Hillier, yet ensuring continuity across all four structure types.

Moreover, this paper introduces a third method of interpreting mean local choice, diverging from both of Hillier's original formulations. We argue that this alternative approach more effectively distinguishes between the four structure types, particularly highlighting the unique functional

effects of the d-structure. We believe this third method aligns more closely with Hillier's intended contribution to the quantitative spatial description methodology, offering a more nuanced and differentiated understanding of each structure type and their respective spatial implications.

4.1 Evaluation based on Hillier's examples of a-, b- and c-structures

In the second section, we outlined Hillier's calculation method for mean local choice in 7-node a-, b-, and c-structure examples: the sum of choices across the steps needed to traverse from one space to traverse through all others via the shortest path.

Considering an a-structure with n nodes (Figure 4.1a), the central node initially has $n-1$ choices. Upon reaching an edge node, it has only one choice, to return towards the centre, followed by $n-2$ choices for the subsequent move. Thus, the central node's total choices sum up to $(n-1)+1+(n-2)+1+\dots+2+1+1$, equalling $(n^2+n-4)/2$. Edge nodes, conversely, start with one choice to move towards the centre, followed by $n-2$ choices and so on. Their total choices sum is $1+(n-2)+1+(n-3)+\dots+2+1+1$, which simplifies to $(n-2)(n+1)/2$. The a-structure, having $n-1$ edge nodes and one central node, thus has a total choice sum of $(n-1)*(n-2)(n+1)/2+(n^2+n-4)/2$, equalling $(n^3-n^2-2)/2$. Given the sum of total traverse steps as $2n^2-4n+1$, as detailed in *Traversability in Spatial Configuration: Some Theoretical and Practical Aspects* (Li, Psarra and Hanna 2024), the mean local choice value for the a-structure is then calculated by dividing the total choices by total steps: $(n^3-n^2-2)/(4n^2-8n+2)$.

The b-structure presents no alternatives along the shortest traversal path (Figure 4.1b). With an even node count, all nodes follow the only possible shortest path. For an odd node count, only the central node initially has one alternative choice (to go left or right), after which the path is fixed. The c-structure is similar, as each node has only one initial choice (Figure 4.1c). Consequently, the mean local choice values for b- and c-structures approximate to 1 for any node count, representing the mathematical minimum value where no alternative choices exist along the traversal.

For the d-structure (Figure 4.1d), following a consistent logic with a-, b-, and c-structures, the central node begins with $n-1$ choices. After an initial choice, it has two choices for the next move, similar to c-structure nodes. Once another choice is made, the only option is to follow the fixed shortest path. The mean local choice sum for this node is $(n-1)+2+1+\dots+1$, equalling $2(n-1)$. For edge nodes, the initial sum is 3 (two choices for adjacent edge nodes, one for the centre), with two choices available until the last node. The sum for edge nodes is thus $3+2+2+\dots+2+1$, which also equals $2(n-1)$. Hence, the overall choice sum for the d-structure is $2n(n-1)$. Dividing this by the total steps, $n(n-1)$, gives a mean local choice value of 2 for any node count.

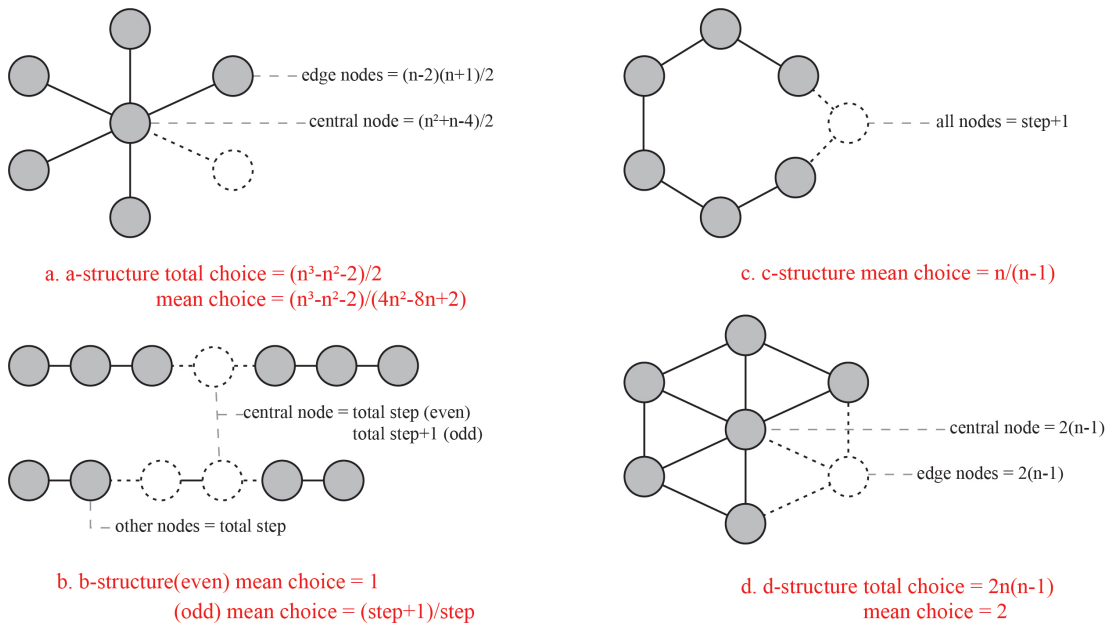

Figure 4.1: Evaluation of mean local choice value equations following Hillier's examples in his 7-node graphs of a-, b- and c-structures.

In summary, employing Hillier's methodology for calculating mean local choice, as demonstrated in his 7-node examples of a-, b-, and c-structures, we observe that the values for b- and c-structures converge to 1 (Figure 4.2), regardless of the graph's node count. The value for the d-structure consistently remains at 2, again independent of node count. In contrast, only the a-structure shows an increase in mean local choice values with an increasing number of nodes. This paper argues that these results seemingly contradict Hillier's original intentions behind proposing mean local choice. Specifically, the d-structure, representing the spatial concept of network (Hillier 2019), does not markedly differ from b- and c-structures in terms of the choice values. This is counterintuitive, given the presence of multiple sub-cycles in the d-structure graph, which should theoretically offer more 'local choices' than what is currently presented. Hence, while we have achieved a continuous definition of mean local choice based on Hillier's proposed method, it appears that this calculation approach may lack practical significance. In the next section we will evaluate the mean local choice based on Hillier's example on the d-structure, to see if this approach offers a more meaningful interpretation.

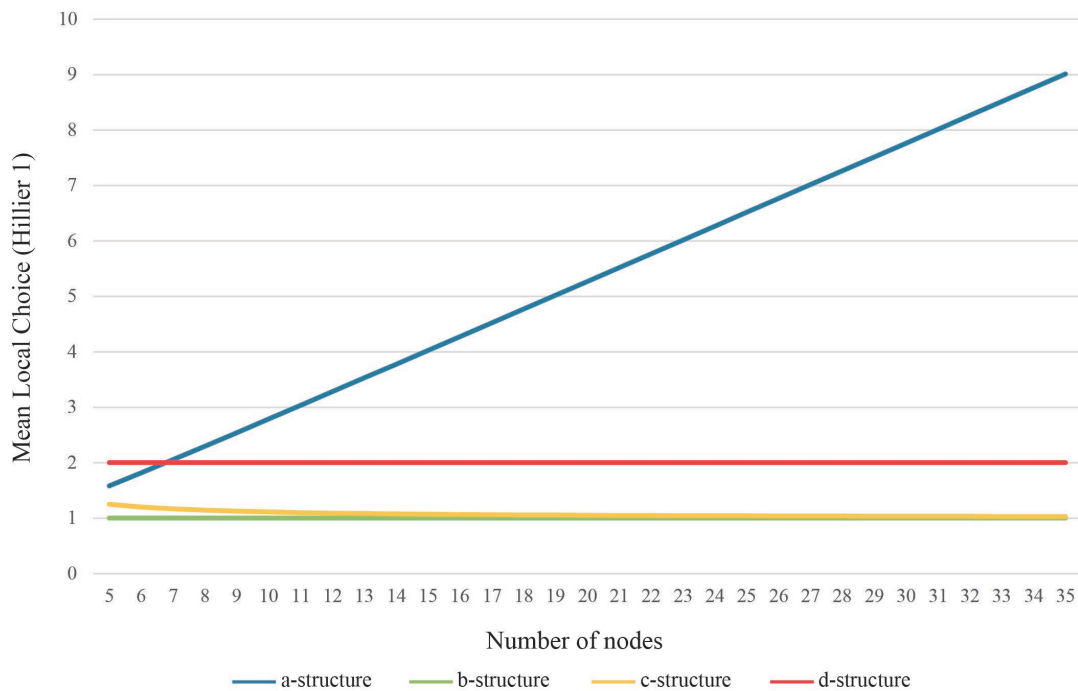

Figure 4.2: Curves of the mean local choice/node number of the four structural types (based on Hillier's examples in his 7-node graphs of a-, b- and c-structures (Hillier 1)).

4.2 Evaluation based on Hillier's examples of the d-structure

As previously discussed, Hillier's method for calculating mean local choice in the 7-node d-structure graph differs from his approach for the other three structures. In the d-structure, Hillier sums all directions at each step along the shortest path, regardless of whether these directions lead back or diverge to a route that is not the shortest.

Applying this logic to an a-structure with n nodes (Figure 4.3a), the central node initially has $n-1$ choices, followed by 1 choice to return, and then $n-1$ choices again, as this approach accounts for all available directions rather than traverse efficiency. The total number of choices for the central node is thus $(n-1)+1+(n-1)+1+\dots+1+(n-1)$, occurring $n-1$ times for moves from centre to edge and $n-2$ times for moves from edge back to centre. This results in a total choice count of $(n-1)*(n-1)+(n-2)*1$, equating to n^2-n-1 . For edge nodes, with $n-2$ moves to and from the centre, the total choices are $(n-2)*(n-1)+(n-2)*1$, equalling n^2-2n . Therefore, the sum of total choices for an a-structure is $(n^2-n-1)+(n-1)(n^2-2n)$, simplifying to n^3-2n^2+n-1 . Dividing by the total steps, the mean local choice value for an a-structure is $(n^3-2n^2+n-1)/(2n^2-4n+1)$.

For b- and c-structures, the calculations are simpler. In the b-structure (Figure 4.3b), all nodes except the two edges have two directions, leading to a sum of choices as twice the traverse steps minus one (the edge), resulting in a mean choice value significantly close to 2. In the c-structure

(Figure 4.3c), all nodes have two directions at every step, yielding a consistent mean choice value of 2, regardless of node count.

In the d-structure (Figure 4.3d), the central node starts with $n-1$ choices, followed by a continuous 3 choices (directions) along the shortest path, totalling $(n-1)+3(n-2)$, or $4n-7$. The edge nodes follow a similar pattern, with 3 directions along the edge and $n-1$ directions upon reaching the centre. Thus, the sum of total choices for the d-structure is $n(4n-7)$. Dividing this by the total shortest path lengths, $n(n-1)$, the mean choice for the d-structure is $4-3/(n-1)$.

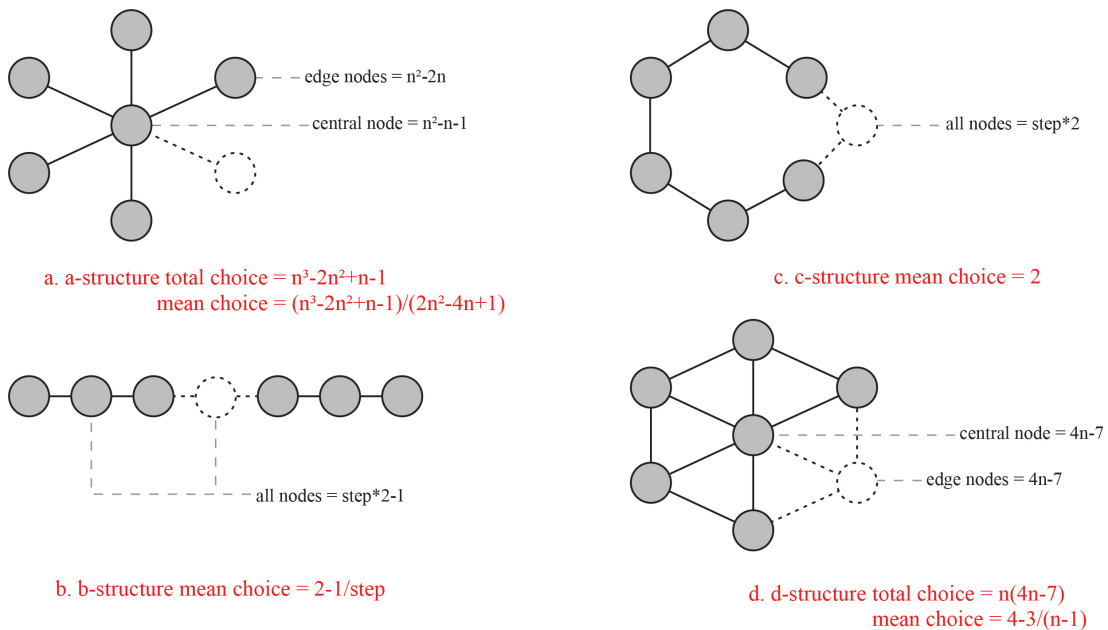

Figure 4.3: Evaluation of mean local choice value equations following Hillier's examples in his 7-node graph of the d-structure.

Summarizing the evaluated equations, Figure 4.4 shows the trends of mean local choice values of the four structural types. Interestingly, the trend mirrors that observed in our first evaluation (Figure 4.2): the a-structure's value increases with node count, while the values for b- and c-structures converge as node count rises, and the d-structure's value is consistently twice that of the b- and c-structures. This paper argues that both evaluative methods, as derived from Hillier's proposals, may not fully capture the theoretical essence intended. The evaluated values cannot illustrate the potential for alternative route choices during traversal—a pivotal aspect of the 'mean local choice' concept we interpret from Hillier's argument. These factors are less about route choice potential within the spatial configuration and more about the immediate options available, which may not align with Hillier's original intention to emphasize the navigational choices inherent in different spatial structures. In other words, Hillier introduced this new spatial measure intended to enrich the quantitative descriptive methodology of space syntax theory. However, the methods he

employed for its calculation do not effectively align with the theoretical significance of the measure.

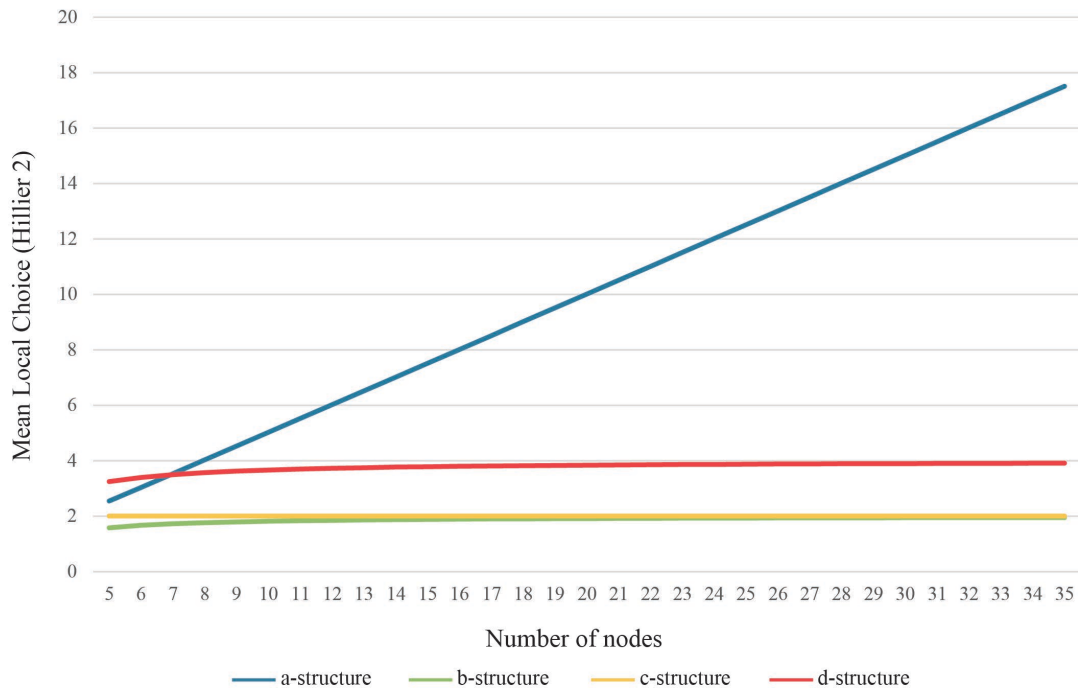

Figure 4.4: Curves of the mean local choice/node number of the four structural types (based on Hillier’s examples in his 7-node graph of the d-structure (Hillier 2)).

4.3 A third way to interpret mean local choice

This paper introduces an alternative approach to defining the concept of 'mean local choice,' which, we believe, more accurately reflects Hillier's theoretical intentions. Unlike the original methods that focus on step-by-step alternatives along a single shortest path, our approach considers all possible shortest paths for each spatial node within the configuration. By aggregating these paths and dividing by the total number of nodes, we get the average number of shortest paths available for traversal from each node to all others. Essentially, this measure quantifies the variety of routes that can be chosen from any given point in a layout, while maintaining optimal traversal efficiency. It should be noted that the new measure is computationally different from what Hillier originally presented in his 2019 study. We keep the name as 'mean local choice' for the reason that we believe this measure reflects the theoretical meanings of what Hillier was trying to explain.

Taking the 7-node d-structure graph as an example, as shown in Figure 4.5, its central node (A) is presented with 12 alternative routes for traversing to all other nodes, each constituting the shortest path requiring six steps. Looking at specific routes, such as route 1 (A-B-C-D-E-F-G) and route 5 (A-D-C-B-G-F-E), we find that despite different initial choices, navigators encounter at the third

node (C), diverge to distinct nodes, and encounter again at the sixth node (F). This pattern of divergence and convergence, facilitated by the graph's structure, reflects Hillier's discussion of the 'churning effect'—a fundamental functional effect of the d-structure that provides pre-conditions for re-encounters among navigators. Our argument is that a greater number of possible shortest traversal paths implies a higher likelihood of such programmed re-encounters, as it signifies increased opportunities for divergence and convergence during individual navigations. Moreover, edge nodes (e.g., node B) exhibit a higher count of potential shortest paths, totalling 18, due to the option of moving towards the centre at each step of the journey along the edges.

Shortest Traverse Path

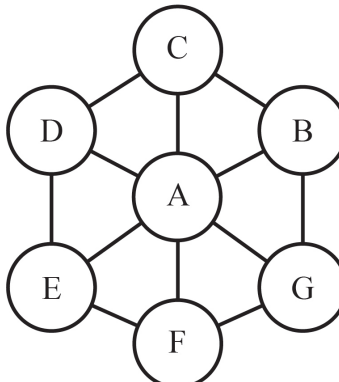

Node A		Node B	
1	A-B-C-D-E-F-G	1	B-A-C-D-E-F-G
2	A-B-G-F-E-D-C	2	B-A-G-F-E-D-C
3	A-C-D-E-F-G-B	3	B-C-A-D-E-F-G
4	A-C-B-G-F-E-D	4	B-C-A-G-F-E-D
5	A-D-C-B-G-F-E	5	B-C-D-A-E-F-G
6	A-D-E-F-G-B-C	6	B-C-D-A-G-F-E
7	A-E-F-G-B-C-D	7	B-C-D-E-A-F-G
8	A-E-D-C-B-G-F	8	B-C-D-E-A-G-F
9	A-F-G-B-C-D-E	9	B-C-D-E-F-A-G
10	A-F-E-D-C-B-G	10	B-C-D-E-F-G-A
11	A-G-B-C-D-E-F	11	B-G-A-C-D-E-F
12	A-G-F-E-D-C-B	12	B-G-A-F-E-D-C
		13	B-G-F-A-C-D-E
		14	B-G-F-A-E-D-C
		15	B-G-F-E-A-D-C
		16	B-G-F-E-A-C-D
		17	B-G-F-E-D-A-C
		18	B-G-F-E-D-C-A

Figure 4.5: All possible shortest paths for the 7-node d-structure's central node(A) and edge node(B).

By applying the newly defined measure of mean local choice, which accounts for all possible shortest paths, we extend our evaluation from the specific 7-node example to a general node count of n . Initially, we discover that the a-structure presents a substantial number of shortest paths available for each node to traverse to all others (Figure 4.6a). Specifically, the central node has $n-1$ initial options to reach an edge node. For each of these initial choices, it subsequently has $n-2$ options for continuing to the next edge node, following a sequence that results in a factorial of $n-1$ ($(n-1)!$) total shortest paths. Similarly, an edge node in the a-structure is presented with $(n-2)!$ shortest paths, as it starts by moving towards the centre, followed by $n-2$ choices thereafter. Consequently, the aggregate number of shortest paths for the a-structure is $(n-1)!+(n-1)*(n-2)!$, simplifying to $2(n-1)!$. Divided by the total node count, the mean local choice for the a-structure is calculated as $2(n-1)!/n$, indicating the average number of possible shortest paths each node has for traversal to all other nodes.

For b- and c-structures, identifying shortest paths is relatively straightforward. In the b-structure with an even node count (Figure 4.6b), each node is limited to a single shortest path. When n is odd, the central node gains an additional path by choosing which end to approach first. On the other hand, all nodes within the c-structure have two available shortest traversal routes (Figure 4.6c), leading to a consistent mean local choice value of 2.

In the d-structure (Figure 4.6d), as exemplified in our 7-node example (Figure 4.5), the central node initiates with $n-1$ choices. For each initial choice leading to an edge node, two alternative route choices emerge, summing to a total of $2(n-1)$ shortest paths for the central node. Edge nodes begin with three options: choosing the centre first leaves 2 route choices as the shortest; traversing along edges provides two choices at each step to either move to the centre or then continue, summing to possible routes as $2(n-3)$. With two directions along the edge, the total possible routes for an edge node in the d-structure amount to $2(n-3)*2+2$, or $4n-10$. Consequently, the overall sum of routes for the d-structure is $2(n-1)+(n-1)*(4n-10)$, simplifying to $4(n-1)(n-2)$. Dividing by n calculates the mean local choice value for the d-structure as $4(n-1)(n-2)/n$.

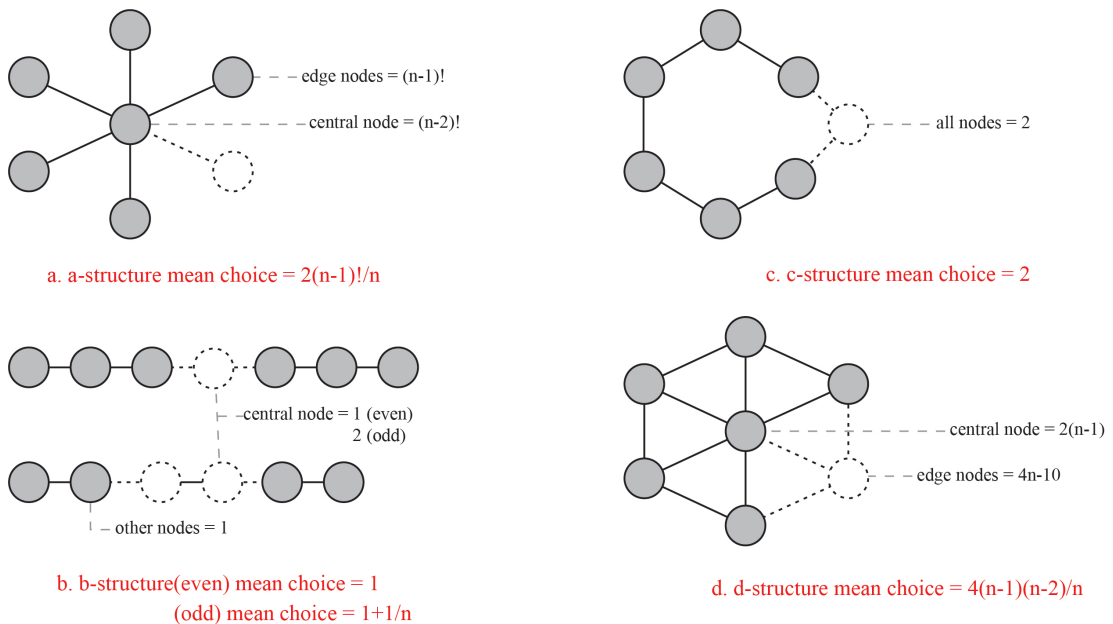

Figure 4.6: Evaluation of mean local choice value equations based on finding all possible shortest paths.

Comparing the mean local choice values across the four structures using our newly proposed measure (Figure 4.7), we find that the a-structure's value is remarkably high due to the factorial basis of its calculation. For instance, with a node count of 10, each space in the a-structure averages 72576 shortest path choices. This paper argues that the new measure is particularly meaningful and

distinct from the previous evaluations based on Hillier’s methods, notably because it shows a clear difference in the d-structure when compared to the b- and c-structures. As the node count increases, the mean local choice value for the d-structure also rises, unlike the static low values for the b- and c-structures. This indicates that a larger node count in the d-structure leads to the creation of more interconnected sub-cycles, thereby enhancing local choices during traversal.

Furthermore, this measure offers a research basis to quantify the average number of shortest paths in real-world configurations. By comparing the calculated mean local choice in real-world layouts with that of the d-structure for an equivalent node count, we can assess whether the real-world configuration's navigational options are relatively high or low in comparison to theoretical models. In the next section, we will extend this analysis to configurations that are in between of the four structures to better understand the practical implications of mean local choice as part of the quantitative spatial description methodology.

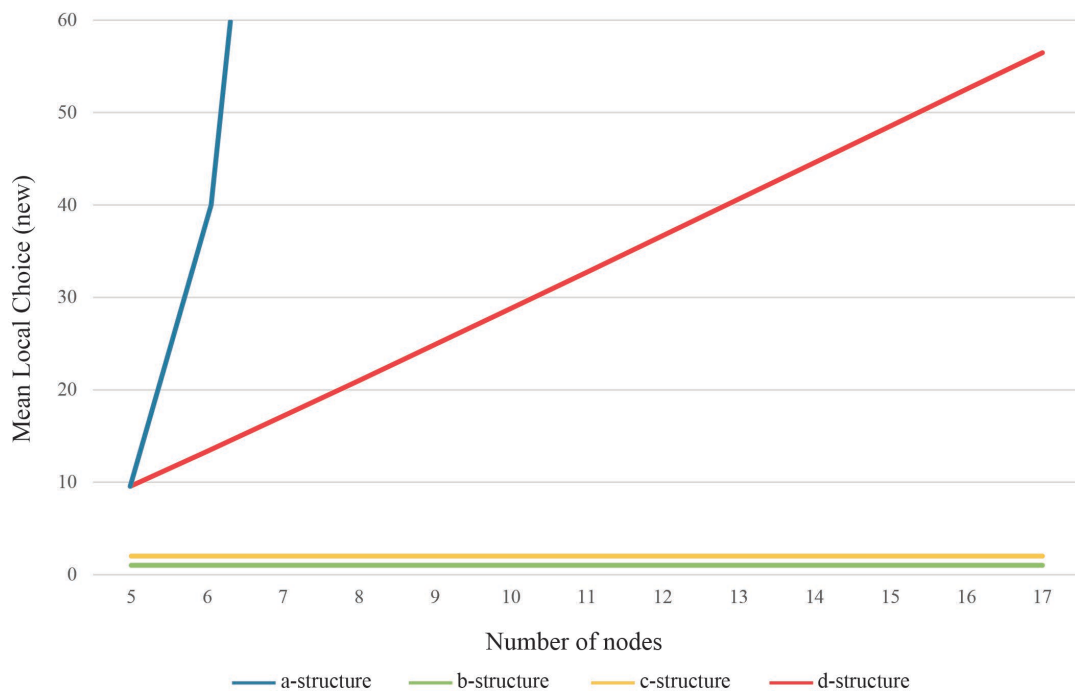

Figure 4.7: Curves of the mean local choice/node number of the four structural types (based on the new measure).

5 MEAN LOCAL CHOICE IN MODIFIED CONFIGURATIONS

To evaluate the practical applications of this newly proposed measure of mean local choice, it is essential to examine spatial factors that might affect its value within spatial configurations, given

that real-world scenarios tend to be more complex than the simplified four theoretical models, often embodying a hybrid of structural types.

Our analysis begins with an examination of the variations in the number of shortest paths within a 7-node d-structure graph, particularly as we progressively disconnect its central node from the surrounding edge nodes, as shown in Figures 5.1i-vi. This investigation utilises a Python-based program developed by the first author, which employs an exhaustive approach to identify all possible shortest paths for every node within the specified graph. Furthermore, we categorize spaces based on their spatial type: a-space signifies a dead-end, b-space indicates a path leading to a dead-end, c-space is part of a single cycle, and d-space offers at least one alternative way back (Hillier 1996; 2019).

As the central node of the d-structure becomes increasingly isolated from the edge nodes, these edge nodes transition from d-spaces to c-spaces. Once the central node retains only two connections (Figure 5.1v), it transforms into a c-space and eventually into an a-space with a single connection remaining (Figure 5.1vi). This transformation significantly affected the number of total paths and, consequently, the mean local choice value. As shown in Table 1, there was a notable decrease in the number of total paths from 120 paths (mean local choice of 17.14) for a theoretical d-structure, down to 18 paths (mean local choice of 2.57), aligning closely with the value characteristic of a c-structure. Furthermore, the loss of connection between the central node and an edge node not only diminished the number of shortest paths for these nodes but also impacted the remaining edge nodes, indicating a closely correlated change in their path options throughout the process.

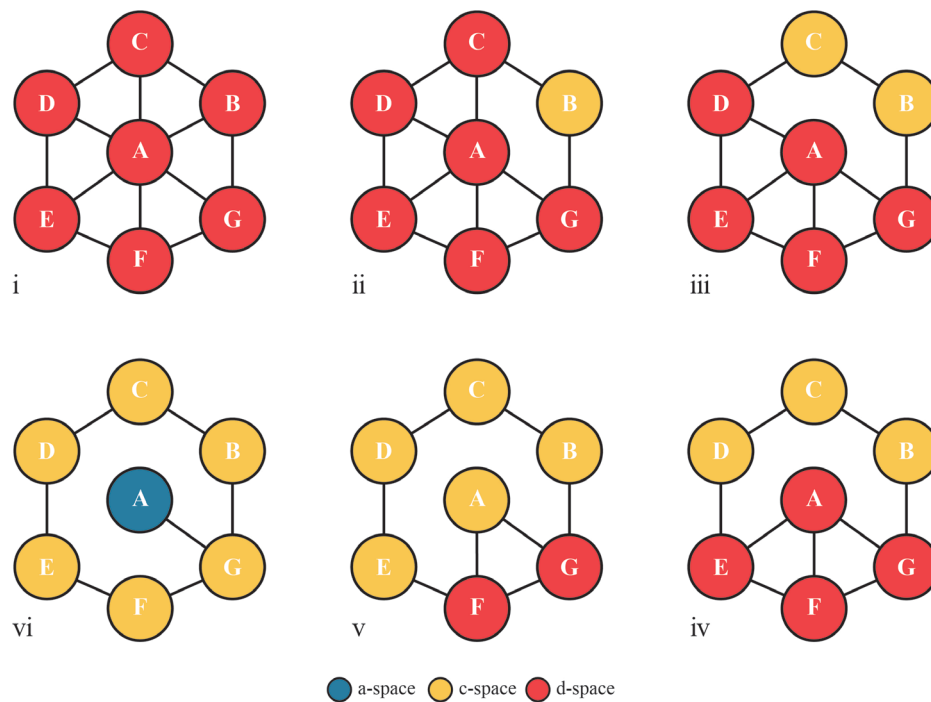

Figure 5.1: Disconnecting the central space of the d-structure, coloured by the spatial types.

Table 1: Numbers of total shortest paths for nodes in Figures 5.1i- vi, and their mean local choices.

	Node A	Node B	Node C	Node D	Node E	Node F	Node G	Total Paths	Mean Choice
i	12	18	18	18	18	18	18	120	17.14
ii	10	16	10	13	12	13	10	84	12
iii	8	9	9	7	9	9	7	58	8.29
iv	6	6	4	6	4	6	4	36	5.14
v	4	3	2	2	3	2	2	18	2.57
vi	2	1	4	2	4	1	4	18	2.57

Exploring the impact of integrating a- and b-spaces into the 7-node d-structure graph, we examine how these additions alter the mean local choice value. Adding one a-space (node H) to the d-structure graph results in a notable decrease in the mean local choice value (Figure 5.2i). Particularly, all nodes, except for node B (which connects to the a-space), experience a significant reduction in their number of possible shortest paths. For example, nodes C, D, and E see their total paths decrease from 18 to just 2 following this spatial modification.

Adding a second a-space to node B (Figure 5.2ii) led to a considerable increase in the mean local choice value, from 8.25 to 20. This increase, however, is predominantly attributed to node B, whose shortest path count jumps from 30 to 84, while other nodes (A, C-F) continue to exhibit severely restricted route options. Shifting the second a-space to node C (Figure 5.2iii) results in low numbers of shortest paths across all nodes, including those connected to a-spaces, leading to a decreased mean local choice value.

Figures 5.2iv and v explore the addition of b-spaces to the graph. In comparison with Figure 5.2i, only node B—the one connected to the a-space—experienced a change in the total number of shortest paths while the values for other nodes remained unchanged. Thus, adding b-spaces does not affect the overall graph but only impacts the local space to which it is connected. This is further illustrated by comparing Figures 5.2vi and ii, where the addition of two b-spaces adjacent to the two a-spaces does not alter the path counts for any existing nodes.

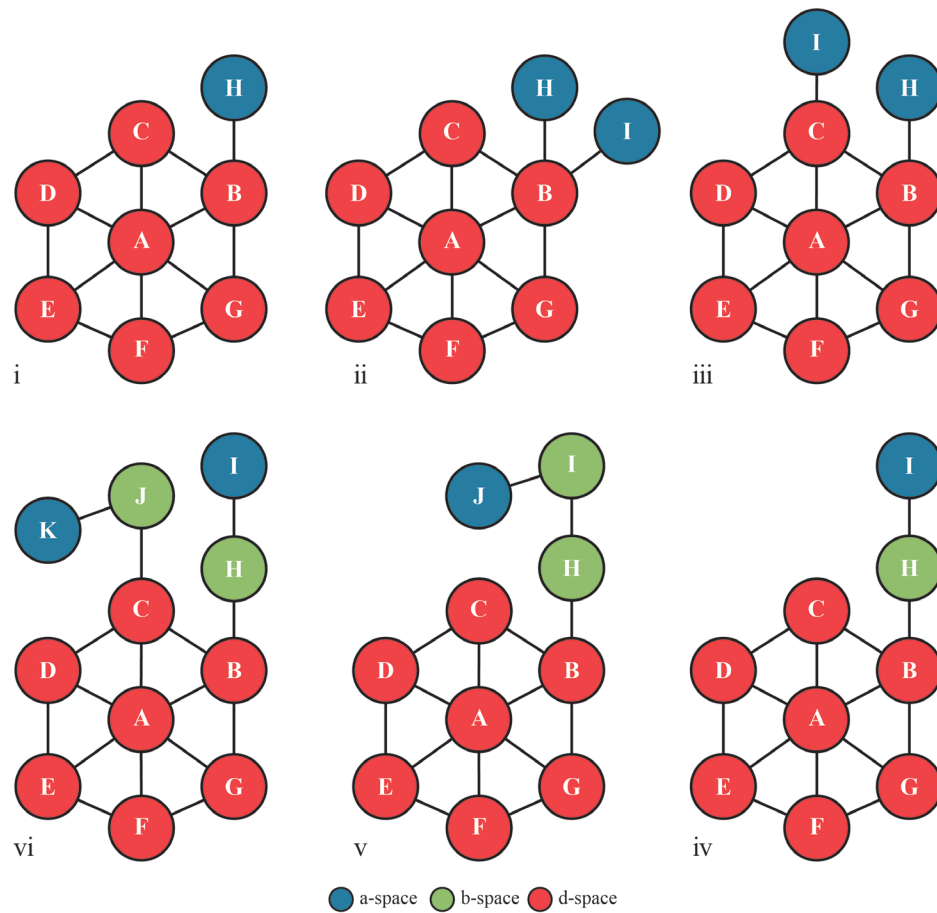

Figure 5.2: Adding a- and b-spaces to the d-structure, coloured by the spatial types.

Table 2: Numbers of total shortest paths for nodes in Figures 5.2i- vi, and their mean local choices.

	Node A	Node B	Node C	Node D	Node E	Node F	Node G	Node H	Node I	Node J	Node K	Total Paths	Mean Choice
i	2	30	5	2	2	2	5	18	/	/	/	66	8.25
ii	4	84	10	4	4	4	10	30	30	/	/	180	20
iii	4	5	5	7	4	4	7	5	5	/	/	46	5.11
iv	2	12	5	2	2	2	5	18	18	/	/	66	7.33
v	2	12	5	2	2	2	5	30	18	18	/	96	9.6
vi	4	5	5	7	4	4	7	5	5	5	5	56	5.09

We next consider the effect of integrating c-spaces, thereby extending sub-cycles within the d-structure, as shown in Figures 5.3i-iv. The addition of c-spaces into the d-structure does not alter the spatial classification of the original nodes (A-G), as these d-spaces continue to offer multiple alternative circulation routes, which are now expanded by the newly added c-spaces. The examination of the shortest paths reveals that expanding a single sub-cycle, as shown in Figures 5.3i-iii, does not affect the available choices for traversal paths. Only when a second sub-cycle is extended, as shown in Figure 5.3iv, is there a slight decrease in the mean local choice value for the entire graph. Despite this reduction, the mean local choice value remains theoretically high, indicating that the fundamental structure and the richness of navigational choices within the d-structure are roughly unaffected by the addition of c-spaces.

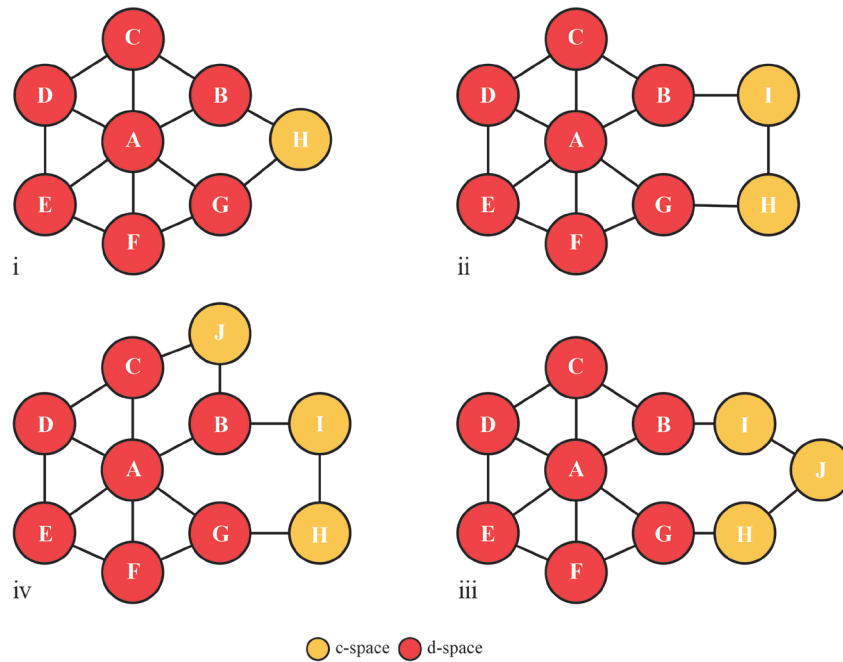

Figure 5.3: Adding c-spaces to the d-structure, coloured by the spatial types.

Table 3: Numbers of total shortest paths for nodes in Figures 5.3i- vi, and their mean local choices.

	Node A	Node B	Node C	Node D	Node E	Node F	Node G	Node H	Node I	Node J	Total Paths	Mean Choice
i	12	13	17	16	16	17	13	20	/	/	124	15.5
ii	12	13	17	16	16	17	13	15	15	/	134	14.89
iii	12	13	17	16	16	17	13	15	10	15	144	14.4
iv	12	8	11	15	14	15	11	13	14	19	132	13.2

Figure 5.4 presents an alternative experiment on a 12-node theoretical layout. This experiment disconnects the two central d-spaces of the graph. Despite their disconnection, these two spaces remain as the d-type since they still sit on two alternative circulations. Looking at the spatial properties, the total number of shortest paths unexpectedly increases from 124 to 192 after the disconnection, although some nodes now have a longer shortest path. Additionally, a shift in the distribution of shortest path counts is observed: prior to the disconnection, the four c-spaces situated at the corners have a higher count of shortest routes; after the disconnection, the d-spaces adjacent to these c-spaces have a comparatively higher number of shortest path choices.

While this paper will not discuss deeply the socio-spatial meanings of these observed changes in spatial properties, it's essential to acknowledge the distinctiveness and relevance of the newly developed mean local choice measure. We argue that this new measure, along with other spatial measures, contributes meaningfully to the development of a quantitative spatial description methodology, aligning with Hillier's proposal in his last work (Hillier 2019).

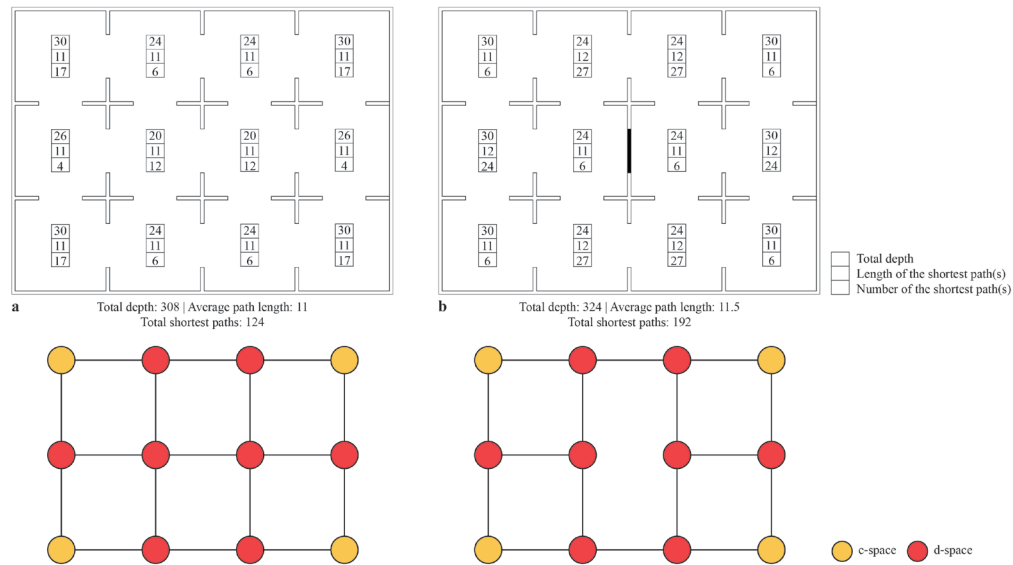

Figure 5.4: An example of cutting one connection in a 12-node graph, how the spatial properties change accordingly while the spatial types remain unchanged.

6 CONCLUSIONS

This paper has explored the concept of mean local choice, a new spatial measure introduced by Hillier in his last work. Initially, it distinguished mean local choice from the existing syntactic choice: the former focuses on evaluating navigational potentials for the traverse through the entire spatial configuration, as opposed to the latter, which concentrates on single origin-destination movements. By highlighting its focus on navigational possibilities across the entire spatial configuration, rather than the origin-destination focus of syntactic choice. This distinction illustrates the theoretical relevance and significance of mean local choice to contribute to the space syntax methodology.

Despite its theoretical significance, our analysis points out deficits and inconsistencies in Hillier's calculation methods for mean local choice within his 7-node examples of the four structural types. In response, this paper introduces an alternative calculation method that considers all possible shortest paths for each node in a configuration, positing that a greater number of navigational options signifies enhanced navigational freedom. Building on this refined approach, the paper extends the evaluation of mean local choice to theoretical models of varying node counts and introduces a Python-based program for analysing real-world configurations, thereby facilitating practical applications of this new measure. Our analysis indicates that modifications to a- and d-spaces are primarily responsible for altering the total count of shortest paths, thus impacting the each for free navigations. On the other hand, the addition of b- and c-spaces—extending the a-structure and enlarging the d-structure, respectively—does not significantly affect the mean local choice value.

As Hillier suggested, ‘*We need to reflect that space syntax is, and always has been, a theory of description*’ (Hillier 2019, p.24), this paper has taken the first step to explore the new concept of mean local choice. The exploration suggests that mean local choice tends to be a key element for enhancing the quantitative descriptive framework of space syntax. Future studies should further explore the patterns of impact of spatial modifications on mean local choice and its implications for practical scenarios, aiming to interpret its effects on spatial functionality and behavioural patterns. Lastly, written by Hillier, ‘*The need to extend this in the direction of structure, should now I think be one of the key theoretical challenges in the future of space syntax*’ (ibid., p.25).

ACKNOWLEDGEMENTS

This work was supported by the Engineering and Physical Sciences Research Council (EPSRC) [grant number EP/R513143/1 and EP/T517793/1].

REFERENCES

- Barabási, A.L. and Oltvai, Z.N. (2004) 'Network biology: understanding the cell's functional organization', *Nature Reviews Genetics*, 5(2), pp. 101-113.
- Brandes, U. (2008) 'On variants of shortest-path betweenness centrality and their generic computation', *Social Networks*, 30(2), pp. 136-145.
- Hillier, B. (1996) *Space is the Machine*, Cambridge: Cambridge University Press; Space Syntax Limited/UCL.
- Hillier, B. (2019) 'Structure or: Does Space Syntax Need to Radically Extend Its Theory of Spatial Configuration?', In *Proceedings of the 12th International Space Syntax Symposium*, Beijing, China.
- Hillier, W.R.G., Yang, T. and Turner, A. (2012) 'Normalising least angle choice in Depthmap-and how it opens up new perspectives on the global and local analysis of city space', *Journal of Space Syntax*, 3(2), pp. 155-193.
- Li, C., Psarra, S., & Hanna, S. (2024). Traversability in Spatial Configuration: Some Theoretical and Practical Aspects. In *Proceedings of the 14th International Space Syntax Symposium*. Nicosia, Cyprus.
- Lü, L., Chen, D., Ren, X.L., Zhang, Q.M., Zhang, Y.C., and Zhou, T. (2016) 'Vital nodes identification in complex networks', *Physics Reports*, 650, pp. 1-63.
- Newman, M.E.J. (2005) 'A measure of betweenness centrality based on random walks', *Social Networks*, 27(1), pp. 39-54.