



2805239647

Investigations in the dynamics of three different classes of meromorphic functions

A thesis presented for the degree of
Doctor of Philosophy of the University of London
and the
Diploma of Imperial College
by

Patricia Domínguez Soto

Department of Mathematics
Imperial College of Science, Technology and Medicine
Queen's Gate, London SW7 2BZ

1998

ProQuest Number: U643408

All rights reserved

INFORMATION TO ALL USERS

The quality of this reproduction is dependent upon the quality of the copy submitted.

In the unlikely event that the author did not send a complete manuscript and there are missing pages, these will be noted. Also, if material had to be removed, a note will indicate the deletion.

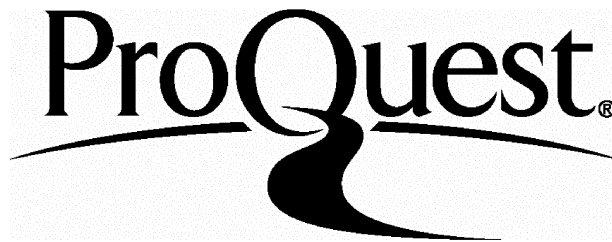

ProQuest U643408

Published by ProQuest LLC(2016). Copyright of the Dissertation is held by the Author.

All rights reserved.

This work is protected against unauthorized copying under Title 17, United States Code.
Microform Edition © ProQuest LLC.

ProQuest LLC
789 East Eisenhower Parkway
P.O. Box 1346
Ann Arbor, MI 48106-1346

X 282716792

0594023

Abstract

This thesis discusses problems about the dynamics of the following three classes of functions: I. Transcendental entire, II. Analytic self-maps of $\mathbf{C}_* = \mathbf{C} \setminus \{0, \infty\}$, and III. Transcendental meromorphic functions.

For an entire function f the Fatou set $F(f)$ is the maximal open set where the iterates f^n form a normal family. The Julia set $J(f)$ is the complement of $F(f)$. For meromorphic functions some modifications of this definition are needed.

In Chapter 2 for a transcendental entire function f we investigate the connectedness properties of the Julia set $J(f)$ in the plane and in the Riemann sphere. We give examples where $J(f)$ contains buried components, that is, components which do not meet the boundary of any component of the complement $F(f)$ of $J(f)$. In connection with an old question of Fatou we show that if $F(f)$ has a multiply-connected component, then $J(f)$ has buried components which are singletons. Such components are dense in $J(f)$.

In Chapter 3 we let f be a non-Möbius analytic self-map of \mathbf{C}_* . Write $J_*(f)$ for the Julia set of f in \mathbf{C}_* and $J(f)$ for the closure of $J_*(f)$ in $\hat{\mathbf{C}}$. Then we have one of the three cases (i) $J(f)$, $J_*(f)$ are connected, (ii) $J(f)$ is connected, $J_*(f)$ has infinitely many components, (iii) $J(f)$ has two components, $J_*(f)$ has infinitely many components. All three cases can occur.

It is known that $F(f)$ has at most one multiply-connected domain A whose connectivity must in fact be two. If in addition A is relatively compact in \mathbf{C}_* , then either A is a Herman ring, A is pre-periodic but not periodic, or A is a wandering component. Examples of all three cases are constructed.

In Chapter 4 we examine some properties of the dynamics of entire functions which extend to general meromorphic functions and also some properties which do not. For a transcendental meromorphic function $f(z)$ whose Fatou set $F(f)$ has a component of connectivity at least three, it is shown that singleton components are dense in the Julia set $J(f)$. Some problems remain open if all components are simply or doubly connected.

Let $I(f)$ denote the set of points whose forward orbits tend to ∞ but never land at ∞ . For a transcendental meromorphic function $f(z)$ we have $J(f) = \partial I(f)$, $I(f) \cap J(f) \neq \emptyset$. However in contrast to the entire case, the components of $\overline{I(f)}$ need not be unbounded, even if $f(z)$ has only one pole.

If $f(z)$ has finitely many poles then, as in the entire case, $F(f)$ has at most one completely invariant component.

Chapter 5 concerns the disconnectedness of $J(f)$ for a transcendental entire function in the case $F(f)$ has an unbounded invariant component U . Then U is simply-connected and if $\Psi : D = D(0,1) \rightarrow U$ is a Riemann map, define $\Theta_\infty = \{e^{i\theta} : \text{radial limit } \Psi(e^{i\theta}) \text{ exists and } = \infty\}$.

If ∞ is accessible in U and U is either (i) an attracting basin, (ii) a parabolic basin or (iii) a Siegel disc, then Θ_∞ is dense in ∂D . If U is a Baker domain and f/U is not univalent, then $\overline{\Theta}_\infty$ contains a non-empty perfect set in ∂D . Examples are given to show that $\overline{\Theta}_\infty$ may be residual or in others cases countable.

Acknowledgements

I wish to thank my supervisor Professor I.N Baker for sharing his knowledge of iteration theory and for his continuous guidance and support throughout my years of PhD studies. It is a great pleasure to have this opportunity to record my immense indebtedness to my supervisor, who was the main source of encouragement behind me presenting two seminars in Cambridge and one at Imperial College.

I would like to express my gratitude to Mrs. G. Baker, who was always very enthusiastic in teaching me about English customs, amongst other things, and in taking me to have lovely walks which I enjoyed tremendously.

I am deeply indebted to friends Maria Alvarez, Adrián Ramírez, Zaineb Bashir-Ali, April Chen, Maxine García, Jonathan Tanner, and Ursula Iturrarán who stood by me throughout my PhD studies. My sincere thanks to all.

I wish to thank the Department of Mathematics at Imperial College, especially to Dr. S. Velani, Prof. C. Atkinson, Dr. C. Barnett, Miss J. Brown, Mrs. C. Boey, Mr. R. Perera, and Mr. A.M. Clark.

Thanks are also due to CONACyT (Consejo Nacional de Ciencia y Tecnología) and Universidad Autonoma de Puebla for their financial support.

Finally, this thesis is dedicated to my mother Maria, my sister Elizabeth and my niece Karen who supported me with their very nice letters, which gave me motivation to continue with my studies, during my stay in London.

Contents

List of Figures	7
Chapter 1 : Introduction	8
1.1 A brief history of the iteration of complex analytic functions	8
1.2 The story of this thesis	10
1.3 Preliminaries	10
Chapter 2 : Connectedness properties of the Julia sets of transcendental entire functions	13
2.1 Introduction to Chapter 2	13
2.2 The Julia set of $f(z) = e^{\lambda z}$	15
2.3 Buried components of $f(z) = e^{\lambda z}$	21
2.4 The Julia set of $\sin z$	22
2.5 Buried points of $\sin z$	24
2.6 Multiply-connected components like rings	24
2.7 Preliminary lemmas	25
2.8 Proof of the main theorem	27
Chapter 3 : Self-maps of the punctured plane	29
3.1 Introduction to Chapter 3	29
3.2 Components of the Fatou set	33
3.3 Connectivity of the Julia set	34
3.4 Buried points and buried components	37
3.5 The doubly-connected component	38
3.6 Proof of Theorem 3.1.5	39
3.7 Proof of Theorem 3.1.6	41
3.8 Proof of Theorem 3.1.7	45
3.9 Final remarks	50
Chapter 4 : Dynamics of transcendental meromorphic functions	52
4.1 Introduction to Chapter 4	52

4.2	Proof of Theorem A	59
4.3	Proofs of Theorems B and C	61
4.4	Proofs of Theorems D and E	62
4.5	Functions with finitely many poles	66
4.6	Orbits which tend to ∞	70
4.7	Completely invariant domains	72
4.8	Singularities of f^{-1} of a transcendental meromorphic function f	75
4.9	Examples	76
Chapter 5 : Boundaries of unbounded Fatou components of entire func-		
	tions	81
5.1	Introduction to Chapter 5	81
5.2	Lemmas on inner functions	85
5.3	Dynamics of inner functions	89
5.4	Proof of Theorems 5.1.1 and 5.1.2	92
5.5	An example which has a Baker domain	94
5.6	Further properties of the preceding example	97
5.7	Further examples	105
5.8	The results of Devaney and Goldberg on λe^z	107
References		113

List of Figures

2.1	Each branch of f^{-1} gives a different component of $f^{-1}(D_p)$	18
2.2	The branches of f^{-1} map Γ_1 to an infinity of paths γ_n in D_p	20
2.3	The component N_n of $F(f)$ between U_n and U_{n+1}	26
2.4	The points $\xi \in V$ and $\hat{\xi} \in \hat{V}$ belong to $J(f)$	28
4.1	The interiors D_i , $1 \leq i \leq 2$, and the exterior D_3	61
4.2	B is the region between $C(0, R)$ and γ	68
4.3	The process	71
4.4	The arcs $\gamma_1, \gamma_2, \delta_1$ and δ'_1	74
4.5	The domain H	77
4.6	$T = S \cap \{z : z - \pi > \rho\}$	78
5.1	The curve μ	87
5.2	e may be continued along $\lambda(t)$	88
5.3	(left) $T \subset D'_n$, (right) $0 \in \partial T$, then $0 \in I'_n$	91
5.4	U is contained in the strip $ y < \pi$ and the lines $y = \pm\pi$ are in $J(f)$. Figure computed by the boundary game method of Weinreich [72]	96
5.5	$\bigcup_1^\infty \beta_n = \beta_1 \cup \alpha_2 \cup \alpha_3 \cup \dots$ is a Jordan curve C	100
5.6	The component D_n	101
5.7	$f^{-1}(L^-) \cap S = L^- \cup M^+$ and $f^{-1}(L^+) \cap S = L^+ \cup M^-$	103
5.8	$S_j, j \in \mathbf{Z}$	108
5.9	$\Psi^{-1}(S_0)$	109
5.10	Diagram showing $\tau_j, g^{-1}(\tau_j) = \Psi^{-1}f^{-1}(\sigma_j)$	110
5.11	The path γ_n	111

C H A P T E R 1

Introduction

1.1 A brief history of the iteration of complex analytic functions

Probably the oldest and most famous iterative process to be found in mathematics is Newton's method

$$z_{n+1} = z_n - \frac{f(z_n)}{f'(z_n)}.$$

It can be used to approximate both real and complex solutions to the equation $f(z) = 0$.

The iteration of complex analytic functions has its origins in two detailed examinations of Newton's method. The first paper, containing two parts (1870 and 1871), was written by the German mathematician Ernest Schröder (1841-1902) and the second (appeared in 1897) by the British mathematician Arthur Cayley (1821-1895).

Schröder and Cayley each studied the convergence of Newton's method for the complex quadratic function. Since then many other mathematicians have worked on the problem of analytic iteration and the iteration of complex functions, see e.g. [3].

In 1907 Paul Montel (1876-1975), a French mathematician, received his doctorate in Paris which was related to infinite sequences of both real and complex functions. A few years later Montel worked in complex function theory and introduced the theory of normal families. In his papers published in 1912 and 1916 he treated Picard's theory. Montel considered his study of Picard's theory to be one of the most important applications of his theory of normal families. In 1917 Montel used normal families to prove the Riemann mapping theorem together with several other theorems related to conformal mapping.

Montel's theory of normal families was quite important in the iteration of analytic functions. Between 1918 and 1920, two French mathematicians, Pierre Fatou (1878-1929) and Gaston Julia (1893-1978) obtained several results related to the iteration of rational functions of a single complex variable. Each of them based his approach on Montel's theory of normal families. The main objects of the theory are the Fatou or stable set where the iterates form a normal family and the Julia set which is the complement of the Fatou set. In 1926 Fatou [40] extended the basic results from the rational case to

the entire case. However, I.N. Baker in [9] showed that some dynamical properties of entire functions may be quite different from those of rational maps.

In 1926 Fatou put forward the following conjecture: $J(e^z) = \widehat{\mathbf{C}}$. The first example (1975) of an entire function with the above property was given by I.N. Baker who proved that $J(\lambda ze^z) = \widehat{\mathbf{C}}$ for suitable value of λ . Later in 1981 Misiurewicz proved Fatou's conjecture.

In 1953 H. Rådström [67] showed that among planar domains with holomorphic self-maps $f : D \rightarrow D$, the most dynamically interesting cases are $D = \widehat{\mathbf{C}}$, f rational, $D = \mathbf{C}$, f entire, or $D = \mathbf{C}_* = \mathbf{C} \setminus \{0\}$. In all other cases every point of D is a stable point for f .

In 1969 P. Battacharyya, in his PhD thesis [25], proved that $\overline{J(f)}$ is the closure of the repelling fixed points in the case when $D = \mathbf{C}_*$.

The dynamics of analytic self-maps of the punctured plane has been studied by many other authors since Rådström and Battacharyya, see [21] for a survey.

The iteration of general meromorphic functions was mainly studied in 1990 and 1991 by I.N Baker, J. Kotus, and Lü Yinian who produced three papers [14]-[16]. The third of those is related to the classification theorem of periodic components, Theorem 2.2 and Theorem 2.3. For a survey of general meromorphic functions the readers are referred to [21].

The above introduction suggests that meromorphic functions fall into four disjoint classes.

- The rational functions (assuming the degree to be at least two).
- The class **E** of transcendental entire functions.
- The class **P** of transcendental functions of the type

$$f(z) = \alpha + (z - \alpha)^{-k} e^{g(z)},$$

for some $k \in \mathbf{N}$ and some entire function $g(z)$.

- **M**, the class called general meromorphic functions in [16], of transcendental meromorphic functions, for which ∞ is not in the set of the exceptional points.

A further generalisation is to study the iteration of functions which are meromorphic outside some set of essential singularities which is in some sense small. See e.g. [44] and [27].

1.2 The story of this thesis

The idea of this thesis started when we found a paper which was written by Jian-Yong Qiao [66] who studied an example of a transcendental entire function which has buried points in the Julia set which are dense in the Julia set (see Chapter 2 for a definition of buried points). C. McMullen [59] had already shown the existence of a rational function whose Julia set contains buried components. Jian-Yong Qiao did not discuss buried components, so we tried to see what happen with buried components for transcendental entire functions. This suggested examining the connectivity of the Julia set.

Fatou's original paper [40] posed the question of whether $J(f)$ could be totally disconnected for transcendental entire functions, as may happen for polynomials. A negative answer was given by I.N Baker [8]. However until now it seems an open question whether singleton components can occur at all for transcendental entire functions. We prove that if the Fatou set of the transcendental entire function $f(z)$ has a multiply-connected component, then $J(f)$ has buried components which are singletons and such components are dense in the Julia set.

After we proved the above result it was natural to try to extend it to the classes **P** and **M**. For the class **P** we found out that the Julia set has no singleton components but we studied the connectivity of the Julia set.

For the class **M** we prove the existence of examples with singleton components which are dense in $J(f)$. Also we study the connectivity of the Julia set for this class of functions, beside the dynamics of meromorphic functions with only finitely many poles.

In [50] Masashi Kisaka study the connectivity of the Julia set for entire functions. He proved that $J(f)$ is disconnected in the cases when U , an invariant unbounded domain component of $F(f)$, is either an attracting basin, parabolic basin, Siegel disc, or a Baker domain in which the function is not univalent. His results are really about the boundary of U in this case and we are able to strengthen them by omitting some of Kisaka's hypotheses.

1.3 Preliminaries

In this section we shall give some definitions and notations which can be found in [2] and [60].

DEFINITION. A set E is **dense in itself** if $E \subset E'$, that is if every point of E is a limit point of the set. The set E is **perfect** if $E = E'$, i.e. if E is both dense in itself and closed.

DEFINITION. E is a **Cantor set** if E is both perfect and nowhere dense.

DEFINITION. A compact connected set with at least two points is called a **continuum**. A non-null open connected set in any space is called a **domain**.

We denote the Riemann sphere by $\hat{\mathbf{C}}$, with its canonical complex structure and topology, by \mathbf{C} the complex plane, and by $\mathbf{C}_* = \mathbf{C} \setminus \{0, \infty\}$ the punctured plane.

According to the Riemann-Koebe uniformization theorem an arbitrary simply-connected Riemann surface is conformally equivalent to one of the following three spaces.

- The unit disc $D(0, 1)$.
- The complex plane.
- The sphere.

The sphere is called an elliptic Riemann surface. The plane and the punctured plane are called parabolic Riemann surfaces; their universal coverings are conformally equivalent to the plane. The remaining Riemann surfaces, whose universal coverings are conformally equivalent to the disc, are called hyperbolic Riemann surfaces.

On any Riemann surfaces S there exists a conformal metric ρ_S of constant curvature. This metric is said to be hyperbolic (or a Poincaré metric) in the case of a hyperbolic surface S , Euclidean in the parabolic case, and spherical in the case of $\hat{\mathbf{C}}$.

DEFINITION. We say that $f(z)$ is **meromorphic** on U , where U is an open set, if $f(z)$ is defined on U except at a discrete set of points which are poles.

Some important cases of this situation are when:

1. $f(z)$ is entire, analytic in $U = \mathbf{C}$ with no poles. If $f(z)$ covers \mathbf{C} a finite number of times, then $f(z)$ is a polynomial otherwise $f(z)$ is a transcendental entire function.
2. $f(z)$ is meromorphic and $U = \hat{\mathbf{C}}$. Then $f(z)$ is rational.

3. $U = D(0, 1)$ and $f(z)$ is analytic.

Picard's theorem states that a single valued function $f(t)$, meromorphic for $t \neq \infty$, which omits three values reduces to a constant. For a proof e.g. [2].

Thus if $f(z)$ is a transcendental entire it already omits ∞ , so it can only omit one more value. This omitted value is called a Picard exceptional value.

DEFINITION. A family F of functions is **normal** in a domain G of \mathbf{C} if every sequence of functions in F contains a subsequence uniformly convergent (in the spherical metric) in each compact subset of G . Note that convergence to an infinite constant is allowed.

With this definition we shall give the following theorem as derived by Montel.

Montel's theorem. If F/K is a family of analytic functions defined on a domain K and the range of F/K omits at least three values in $\widehat{\mathbf{C}}$, then F/K is normal.

Singularities

Let $f(z)$ be a meromorphic function. The singularities of f^{-1} can arise in two different ways,

1. If $f(z) \neq \infty$ and $f'(z) = 0$, then $f(z)$ is an **algebraic singularity** of f^{-1} and is known as a critical value of $f(z)$, z is called a critical point of $f(z)$. If $f(z)$ has a pole of order $k > 1$ at z , then ∞ is a critical value and z is a critical point.
2. If $f(z)$ is transcendental and there is a path Γ in \mathbf{C} such that, as $z \rightarrow \infty$ on Γ , $f(z) \rightarrow \alpha$, $\alpha \in \widehat{\mathbf{C}}$ on $f(\Gamma)$, α is said to be a **transcendental singularity** of f^{-1} .

More definitions and results for iteration theory are provided as required in Chapters 2, 3, 4 and 5.

C H A P T E R 2

Connectedness properties of the Julia sets of transcendental entire functions

2.1 Introduction to Chapter 2

For a transcendental entire function f we investigate the connectedness properties of the Julia set $J(f)$ in the plane and in the Riemann sphere. We give examples where $J(f)$ contains buried components, that is, components which do not meet the boundary of any component of the complement $F(f)$ of $J(f)$. In connection with an old question of Fatou we show that if $F(f)$ has a multiply-connected component, then $J(f)$ has buried components which are singletons. Such components are dense in $J(f)$.

If $f(z)$ is a transcendental entire function of the complex variable z , we denote by f^n , $n \in \mathbb{N}$, the n -th iterate of $f(z)$. The Fatou set is defined by $F(f) = \{z : \{f^n\}$ is a normal family in some neighbourhood of $z\}$. The complement $J(f)$ of $F(f)$ is called the Julia set.

The iterations of entire functions were first studied by Fatou [39, 40] who proved the facts which follow.

The Julia set $J(f)$ is non-empty and perfect. Further $J(f)$ is completely invariant, that is, z is in $J(f)$ if and only if $f(z)$ is in $J(f)$. The Fatou set is also completely invariant. This implies that for a component G of $F(f)$ and each $n \in \mathbb{N}$ there is a component G_n of $F(f)$ such that $f^n(G) \subset G_n$. If the G_n are different for different n then G (and all G_n) are called wandering components.

A point z_0 is a cyclic point of $f(z)$ with period n if $f^n(z_0) = z_0$ and $f^k(z_0) \neq z_0$ for $k < n$. The derivative $(f^n)'(z_0)$ is called the multiplier of z_0 and all points of a cycle have the same multiplier. In the case $n = 1$ we say z_0 is a fixed point. A cyclic point z_0 of period n is said to be attracting, repelling or neutral according as $|(f^n)'(z_0)|$ is < 1 , > 1 or $= 1$.

The Julia set of transcendental entire functions is unbounded and some writers include ∞ as a member of $J(f)$. For clarity we write $J(f)$ for the Julia set containing ∞ and $J_0(f)$ for $J(f) \cap \mathbf{C}$. The connectivity properties of $J(f)$ as a subset of $\widehat{\mathbf{C}}$ and $J_0(f)$ as a subset of \mathbf{C} may differ. If we say that $J(f)$ is connected we mean that it is connected as a subset of $\widehat{\mathbf{C}}$, while the connectedness of $J_0(f)$ refers to its properties as a subset of \mathbf{C} .

An important class of entire functions is the class S of functions $f(z)$ such that the set of singular points of f^{-1} is finite. S contains the functions $\sin z$ and $e^{\lambda z}$ for constant λ . For $f(z) \in S$ it is always true by Theorem 2.2.3 that $J(f)$ is connected but $J_0(f)$ may or may not be. It will be shown in Sections 2.2 and 2.4 that $J_0(\sin z)$ is connected (Theorem 2.4.1) but for many values of λ $J_0(e^{\lambda z})$ is not (Theorem 2.2.8).

In [10] functions $f(z)$ were constructed such that $F(f)$ contains some components which roughly speaking are an unbounded sequence of concentric rings. For such functions neither $J_0(f)$ nor $J(f)$ is connected. Finally, whenever $J_0(f)$ is connected, then so is its closure $J(f)$.

Fatou's original paper [40] posed the question of whether $J(f)$ could be totally disconnected for transcendental entire functions, as may happen for polynomials. A negative answer was given in [8]. However until now it seems an open question whether singleton components can occur at all for transcendental entire functions. One of our main results in Section 2.8 is

THEOREM A. *If $f(z)$ is a transcendental entire function and $F(f)$ has a multiply-connected component, then $J(f)$ has some singleton components and such components are dense in $J(f)$.*

Many examples of such $f(z)$ are known, for example those from [10] referred to above.

There has been some recent work on buried points and components of $J(f)$. If some component of $J(f)$ does not meet the boundary of any component of $F(f)$ it is called a *buried component* of $J(f)$. Similarly if a point of $J(f)$ is not in the boundary of any component of $F(f)$ it is called a *buried point*. We remark that for a point to be buried is a stronger property than for it to be inaccessible from all components of $F(f)$.

Thus, for example, if $e^{\lambda z}$ has an attracting fixed point (that is, if $\lambda = te^{-t}$ where $|t| < 1$), then $F(e^{\lambda z})$ is a single connected domain whose boundary is $J(e^{\lambda z})$. As remarked in Devaney and Goldberg [30] for these values of λ the set $J(e^{\lambda z})$ consists of a 'Cantor bouquet' of curves each of which contains many points inaccessible from $F(f)$.

However, these points are certainly boundary points of the domain $F(f)$ and $J(f)$ has no buried points.

The first example of buried components of a rational function was given by C. McMullen [59] (see also A.F. Beardon [20]). The first discussion for transcendental entire functions was given by Jian-Yong Qiao [66] who showed that for $0 \leq \mu < 2.5$ the function $f(z) = z \exp(z + \mu)$ has buried points in $J(f)$ (repelling periodic points) and that these points are dense in $J(f)$; he did not discuss buried components. It is shown in Section 2.3 that for values of λ such that $f(z) = e^{\lambda z}$ has an attracting p cycle with $p \geq 2$, $J_0(f)$ has unbounded buried components (there are many such values of λ including all $\lambda < -e$, see, for example, [18]).

In Section 2.5 we show that $J_0(g)$ has buried points for $g(z) = \sin z$. Since $J_0(g)$ is connected and contains 0, which is accessible from one of the components of the Fatou set, there is no buried component.

Finally, Theorem A is strengthened by the following result.

THEOREM 2.8.1. *If the Fatou set of the transcendental entire function $f(z)$ has a multiply-connected component, then $J(f)$ has buried components which are singletons. Such components are dense in $J(f)$.*

2.2 The Julia set of $f(z) = e^{\lambda z}$

In this section we shall prove in Theorem 2.2.8 and Theorem 2.2.9 that $J_0(f)$ is not connected and that its components are unbounded.

We shall often use the following topological lemmas.

LEMMA 1 [60, p.143]. *If X and Y are two components of a closed set F in $\hat{\mathbf{C}}$ there is a polygon in F^c separating X and Y .*

LEMMA 2. *For any closed set A in \mathbf{C} a bounded component K of A is also a component of $A \cup \{\infty\}$ in $\hat{\mathbf{C}}$.*

Proof. The proof follows easily from e.g. Exercise 4 in [73, p.38].

THEOREM 2.2.1 [10]. *If $f(z)$ is a transcendental entire function and U is a multiply-connected component of $F(f)$ then $f^m(z) \rightarrow \infty$ in U as $m \rightarrow \infty$.*

THEOREM 2.2.2 [35]. *Let $f(z) \in S$ be a transcendental entire function. If $z \in F(f)$ then the orbit $\{f^m(z)\}_{m=0}^{\infty}$ does not tend to ∞ .*

THEOREM 2.2.3. *For any transcendental entire $f(z)$ in class S , $J(f)$ is connected in $\widehat{\mathbf{C}}$. In particular this holds for $f(z) = e^{\lambda z}$.*

Proof. We suppose that $J(f)$ is not connected in $\widehat{\mathbf{C}}$ and that there is a component C_1 of $J(f) \subset \widehat{\mathbf{C}}$ distinct from the component C_2 of $J(f)$ which contains ∞ .

It follows from Lemma 1 that there is a simple polygon γ in $(J(f))^c = F(f)$ which separates C_1 and C_2 . Since $\gamma \in F_1$, where F_1 is a component of $F(f)$ which is multiply-connected then it follows from Theorem 2.2.1 that $f^m(z) \rightarrow \infty$ uniformly in F_1 . But this contradicts Theorem 2.2.2.

COROLLARY 2.2.4 [18]. *If $f(z) = e^{\lambda z}$, $\lambda \neq 0$, then any component of $F(f)$ is simply-connected.*

In [18] there is a discussion of the set L_p of values of λ such that $f(z) = e^{\lambda z}$ has an attracting cycle of period $p \geq 1$. It is shown that for every $p \geq 1$ the set $L_p \neq \emptyset$ and in particular all real $\lambda < -e$ are in L_2 . Further, for $p > 2$ the set L_p meets the strip $|\operatorname{Im}\lambda| < 2\pi$ in points such that $\operatorname{Re}\lambda$ is arbitrarily large.

Now we shall need the following theorems which were proved by Fatou and by Baker and Rippon.

THEOREM 2.2.5 [39]. *If $\alpha_1, \dots, \alpha_p$ is an attracting periodic cycle of an entire function $f(z)$, then all of the components of $F(f)$ which contain points $\alpha_1, \dots, \alpha_p$ are simply-connected and one of them contains a singular point of f^{-1} .*

THEOREM 2.2.6 [18]. *For $f(z) = e^{\lambda z}$, $\lambda \neq 0$, there is no component D of $F(f)$ and no sequence of integers n_i such that $n_i \rightarrow \infty$ and $f^{n_i}(z) \rightarrow \infty$ in D .*

THEOREM 2.2.7 [18]. *Let $f(z) = e^{\lambda z}$ where $\lambda \in L_p$, $p > 1$, so that there is a cycle D_1, D_2, \dots, D_p of components of $F(f)$, such that for $1 \leq i < p$, $f(D_i) = D_{i+1}$, $f(D_p) = D_1$, and f^{np} converges to a fixed point of f^p in each D_i . Then every component D of $F(f)$ satisfies $F^N(D) \subset D_i$ for some N, i .*

Now suppose λ is any value such that $f(z) = e^{\lambda z}$ has an attracting p -cycle $p \geq 2$. Let D_1, D_2, \dots, D_p be the periodic cycle of components of $F(f)$ which contain the attracting

periodic cycle $\alpha_1, \dots, \alpha_p$. Then one of the D_j , which we may assume to be D_1 , contains the unique singular point zero of f^{-1} by Theorem 2.2.5.

Let $U = D(0, e^{-a})$, $a > 0$, be a small disc around zero in D_1 . So D_p contains a full inverse image $f^{-1}(U) = \frac{1}{\lambda} \ln U$, that is, a half-plane. Thus D_p is unbounded and all components of $F(f)$ are simply-connected by Corollary 2.2.4. Further, D_p contains a path $\Gamma : \frac{-ta}{\lambda}$, where $t \geq 1$ and $a > 0$. Γ runs to ∞ in D_p ; the image of Γ under $e^{\lambda z}$ is the real segment $(0, e^{-a}) \subset U$.

Each branch of f^{-1} is univalent in the simply-connected component D_p , so each branch gives a different component of $f^{-1}(D_p) = D_{p-1} + \frac{2\pi ik}{\lambda}$, $k \in Z$, which contains a path Γ_{p-1} to ∞ (see Figure 2.1).

$$\begin{aligned} \Gamma_{p-1} &: \frac{1}{\lambda} \ln \left(\frac{-ta}{\lambda} \right), \quad t \geq 1, \\ &= \frac{1}{\lambda} \left\{ \ln \frac{ta}{|\lambda|} + i \arg \left(\frac{-ta}{\lambda} \right) \right\} \\ &= \frac{1}{\lambda} \left\{ \ln \frac{ta}{|\lambda|} + i(2v+1)\pi - i \arg \lambda \right\}, \text{ for some integer } v, \\ &= \frac{1}{\lambda} \{A + iB\}, \text{ say.} \end{aligned}$$

Thus on

$$\Gamma_{p-1} : \begin{cases} \operatorname{Re} \lambda z = A \rightarrow \infty \text{ as } t \rightarrow \infty \\ \operatorname{Im} \lambda z = B \text{ is a constant.} \end{cases}$$

Now we shall prove the following lemma.

LEMMA 3. *If $\Gamma : \frac{1}{\lambda}(A(t) + iB(t))$, $t \geq t_0$ is a curve on which $\operatorname{Re} \lambda z = A(t) \rightarrow \infty$ and $\operatorname{Im} \lambda z = B(t) \rightarrow$ a constant θ , then for any branch f^{-n} of the inverse of f^n , $\Gamma' = f^{-n}(\Gamma)$ is given by $z(t)$, where $\operatorname{Re} \lambda z \rightarrow \infty$ and $\operatorname{Im} \lambda z \rightarrow$ a constant θ_n as $t \rightarrow \infty$.*

Proof. We shall prove this lemma by induction. For $n = 1$, we define $\eta_1 = \arg(A(t) + iB(t))$, $t \geq t_0$, so that $\eta_1 \rightarrow 0$ as $t \rightarrow \infty$. For sufficiently large t_1 we have $A(t) \neq 0$ for $t \geq t_1$ and for this parameter range

$$\Gamma' : \frac{1}{\lambda} \ln \left(\frac{A(t) + iB(t)}{\lambda} \right), \quad t \geq t_1,$$

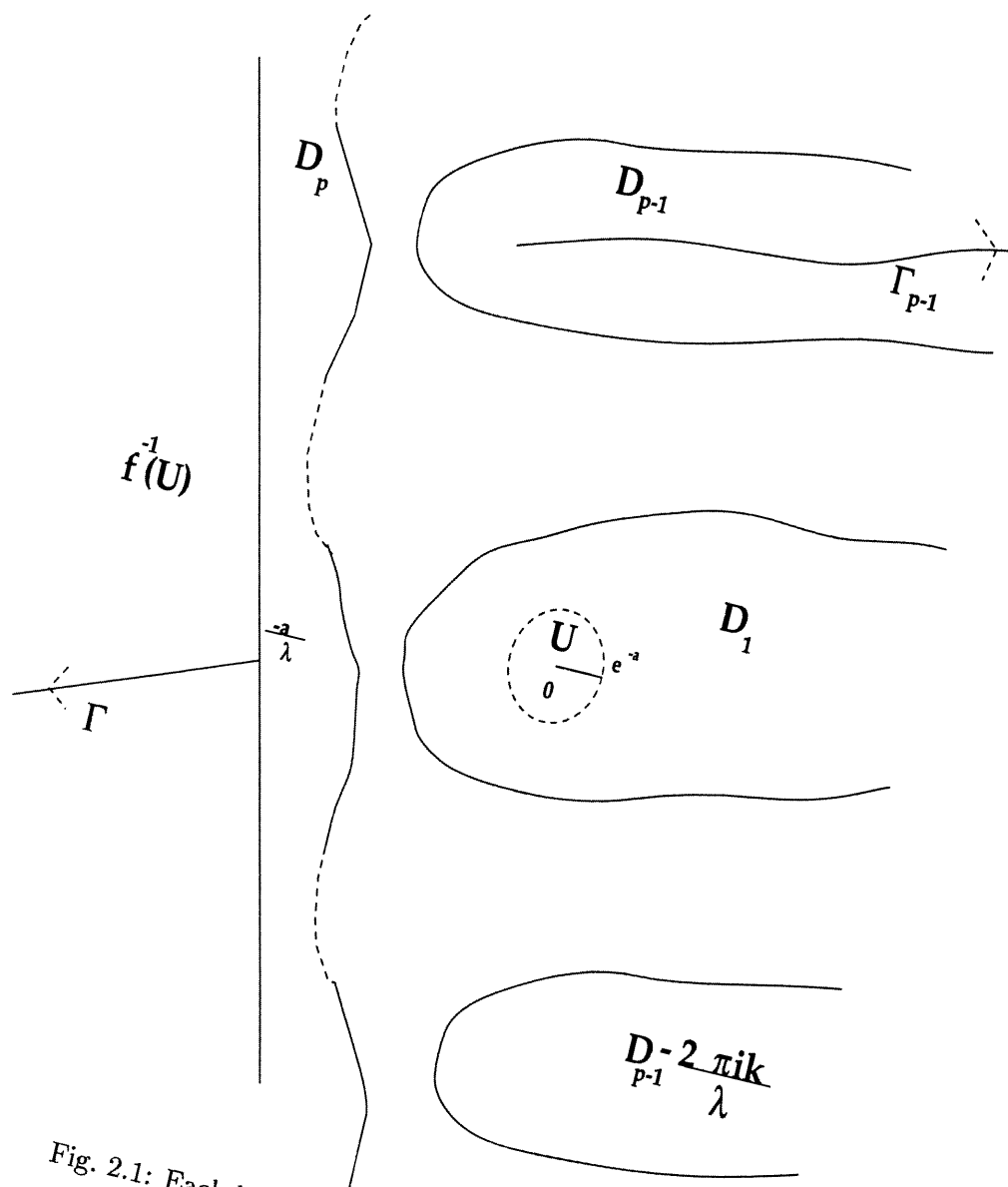

Fig. 2.1: Each branch of f^{-1} gives a different component of $f^{-1}(D_p)$

$$\begin{aligned}
 &= \frac{1}{\lambda} \left\{ \ln \frac{|A + iB|}{|\lambda|} + i \arg \left(\frac{|A + iB|}{\lambda} \right) \right\} \\
 &= \frac{1}{\lambda} \left\{ \ln \frac{|A + iB|}{|\lambda|} + i(\eta_1 + (2v)\pi - \arg \lambda) \right\}, \text{ for some integer } v, \\
 &= \frac{1}{\lambda} \{A_1 + B_1\},
 \end{aligned}$$

where

$$A_1 = \ln \frac{|A + iB|}{|\lambda|} \quad \text{and} \quad B_1 = \eta_1 + (2v)\pi - \arg \lambda,$$

B_1 is continuous on Γ and $\eta_1 \rightarrow 0$. Hence for large $|z|$, v is constant on Γ , thus $B_1 \rightarrow$ constant θ_1 , $A_1 \rightarrow \infty$.

Repeating this argument we obtain that for each curve $\Gamma' = f^{-n}(\Gamma)$

$$\Gamma' : \begin{cases} \operatorname{Re} \lambda z = A_n \rightarrow \infty \text{ as } t \rightarrow \infty \\ \operatorname{Im} \lambda z = B_n \rightarrow \text{constant } \theta_n. \end{cases}$$

Here

$$A_n = \ln \frac{|A_{n-1} + iB_{n-1}|}{|\lambda|} \quad \text{and} \quad B_n = \eta_n + (2v)\pi - \arg \lambda,$$

B_n is continuous on Γ and $\eta_n \rightarrow 0$. Hence for large $|z|$, v is constant on Γ , thus $B_n \rightarrow$ constant θ_n , $A_n \rightarrow \infty$.

Now we shall give an application of this lemma.

We know that D_p contains a path Γ and D_{p-1} contains a path Γ_{p-1} . By Lemma 3, we can affirm that each of D_1, D_2, \dots, D_p contains a path to ∞ where $\operatorname{Re} \lambda z \rightarrow \infty$ and $\operatorname{Im} \lambda z \rightarrow \text{constant}$. Even more, D_1 contains a path Γ_1 to ∞ and we can assume that Γ_1 starts at 0 with the segment $[0, e^{-a}]$, does not otherwise pass through 0 and that $\operatorname{Im} \lambda z$ is bounded on Γ_1 ($|\operatorname{Im} \lambda z| < k$).

Now the branches of f^{-1} map Γ_1 to an infinity of paths γ_n in D_p which tend to ∞ in the half plane $\operatorname{Re} \lambda z > 0$. One of these, γ_1 say, contains the path $\Gamma = \{\frac{-ta}{\lambda}, t \geq 1\}$, so we have $\lambda z \rightarrow -\infty$ along this part of Γ while $\lambda z \rightarrow +\infty$ along another. Moreover $\gamma_{n+1} = \gamma_n + \frac{2\pi i}{\lambda}$. Thus each γ_n divides the plane and D_j , $j \neq p$, lies between two of these paths γ_n , say γ', γ'' (shown in Figure 2.2 as γ_1 and γ_2).

THEOREM 2.2.8. *If $f(z) = e^{\lambda z}$ has an attracting p -cycle $p \geq 1$, then $J_0(f)$ is not connected in \mathbb{C} .*

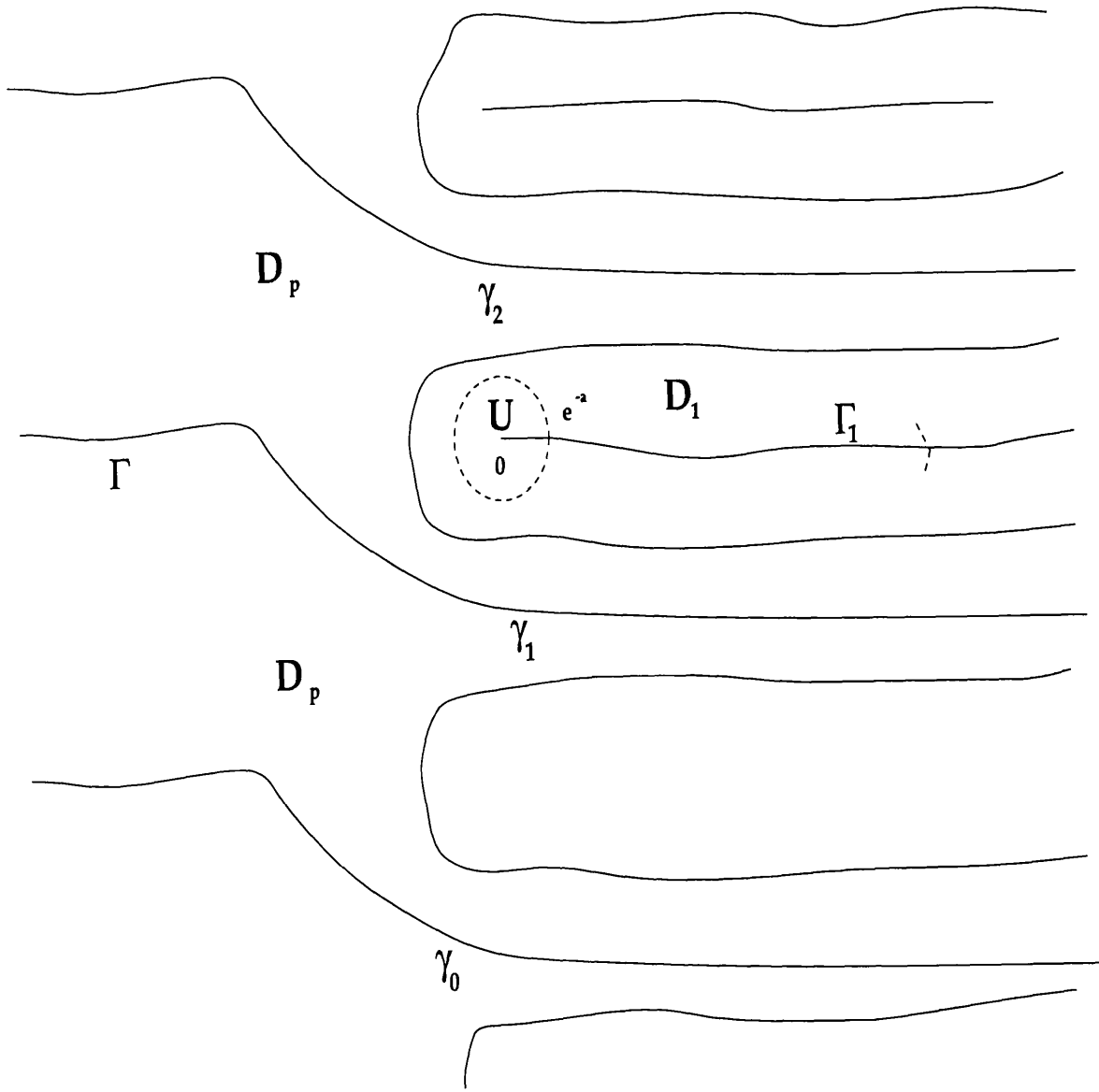

Fig. 2.2: The branches of f^{-1} map Γ_1 to an infinity of paths γ_n in D_p

Proof. For the case $p \geq 2$ we continue the preceding discussion. Then D_1 lies between γ_1 and γ_2 . The curves $\gamma_1 \cup \gamma_2$ in $F(f)$ separate $\partial D_1 \subset J_0(f)$ from $\partial(D_1 + \frac{2\pi i}{\lambda})$ in $J_0(f)$, so $J_0(f)$ is not connected.

For the case $p = 1$ the discussion is simpler. In this case $J_0(f)$ consists of separate Cantor bouquets, [30], separated by strips which belong to $F(f)$.

THEOREM 2.2.9. *If $f(z) = e^{\lambda z}$ has an attracting p -cycle $p \geq 1$, then every component of $J_0(f)$ is unbounded.*

Proof. We suppose that there is a bounded component K of $J_0(f)$. It follows from Lemma 2 that K is also a component of $J_0(f) \cup \{\infty\} = J(f)$. But by Theorem 2.2.3, $J(f)$ is connected in $\widehat{\mathbb{C}}$ and unbounded. Hence we have a contradiction.

2.3 Buried components of $f(z) = e^{\lambda z}$

If there is some component of $J(f)$ which does not meet the boundary of any component of $F(f)$, then it is called a buried component of $J(f)$.

We shall be interested in proving some results about buried components of the transcendental entire function $f(z) = e^{\lambda z}$.

THEOREM 2.3.1. *Suppose λ any value such that $f(z) = e^{\lambda z}$ has an attracting p -cycle, $p \geq 2$, then all the repelling fixed points of $f(z)$ are buried points of $J_0(f)$, with at most finitely many exceptions.*

Proof. Note that for $f(z) = e^{\lambda z}$ all solutions of $e^{\lambda z} = z$ of large modulus are repelling fixed points and hence belong to $J_0(f)$.

We take such a repelling fixed point ξ and suppose that $\xi \in \partial F_1$, where F_1 is a component of $F(f)$ with boundary ∂F_1 . Then $\xi = f^k(\xi) \in \partial F_{k+1}$ where $F_{k+1} = f^k(F_1)$. Hence $\xi \in \partial D_j$ for each D_j of the periodic cycle, since F_k is eventually in D_j . In particular, $\xi \in \partial D_1$. Also D_1 lies in a region where the $\text{Im} \lambda z$ is bounded.

On the other hand the solutions z_n of $e^{\lambda z} = z$ have $|z_n| \rightarrow \infty$, which shows that $\text{Re} \lambda z_n = \ln |z_n| = o(|z_n|)$, so $\text{Im} \lambda z_n \rightarrow \infty$. Thus for all but a finite number of choices of $\xi = z_n$ we have that ξ does not belong to the boundary of D_1 . Consequently ξ is not in the boundary of any component F_1 of $F(f)$. For this reason ξ is a buried point of $J(f)$.

THEOREM 2.3.2. *If λ satisfies the assumptions of Theorem 2.3.1, then some components of $J_0(f)$ are buried components.*

Proof. Let ξ be some repelling fixed point of $f(z)$, $\xi \in J_0(f)$ and let γ be the component of $J_0(f)$ which contains ξ . Since γ is closed and connected, $f(\gamma)$ has the same properties as γ and $\xi \in f(\gamma)$. Since by invariance of the Julia set $f(\gamma)$ belongs to some component of $J(f)$, we have $f(\gamma) \subset \gamma$ and $f^k(\gamma) \subset \gamma$ for all $k \in \mathbb{N}$.

Now we take γ to be the component of $J_0(f)$ which contains a repelling fixed point ξ not between γ_1, γ_2 in Figure 2.2. Thus γ lies between γ_i, γ_{i+1} for some $i \neq 1$.

Now we take ξ_1 a point in γ , $\xi_1 \neq \xi$ and suppose that $\xi_1 \in \partial F_1$. Then $f^k(\xi_1) \in \gamma$ and $f^k(\xi_1) \in \partial F_{k+1}$ where $\partial F_{k+1} = f^k(\partial F_1)$, ∂F_{k+1} meets the strip between γ_i, γ_{i+1} thus F_{k+1} lies in this strip.

But for some k , $F_{k+1} = D_1$. Since D_1 does not lie between γ_i, γ_{i+1} , this is a contradiction. Hence γ is a buried component.

We recall that by Theorem 2.2.9 every component of $J_0(f)$ is unbounded. We also remark that since the inverse image under f^n of a buried component of $J_0(f)$ is buried, such components are dense in $J_0(f)$.

2.4 The Julia set of $\sin z$

We know that $f(z) = \sin z$ belongs to the class S and all finite singularities of f^{-1} are algebraic branch points over $+1$ or -1 .

From the local behavior of iterations of $\sin z = z - \frac{z^3}{6} + \dots$, $F(f)$ has two leaves near 0 and each of these, D_+, D_- , is an invariant component of $F(f)$ in which $f^n(z) \rightarrow 0$. These are the only periodic domains, since they contain the singular points $+1, -1$ of f^{-1} .

Since there are no wandering domains [35], every component D of $F(f)$ has $f^n(D) \subset D_+$ (or D_-) for $n \geq n_0$.

If D_+ is the 'leaf' of $F(f)$ at 0 which contains $(0, \epsilon)$ we see that for any $x \in (0, \pi)$, $f^n(x) \rightarrow 0$ through positive values, so $x \in D_+$. On the other hand $x = 0$ belongs to $J_0(f)$ and so π also belongs to $J_0(f)$ ($f(\pi) = 0$).

We know by Theorem 2.2.2 that $f^n(z) \rightarrow \infty$ implies $z \in J_0(f)$ for $f(z)$ in S . Thus the imaginary axis belongs to $J_0(f)$. Further since $\sin(z + \pi) = -\sin z = \sin(-z)$ we see

that $J_0(f)$ is invariant under $z \rightarrow z + \pi$ and $z \rightarrow -z$. Thus every line $L_n = \{z : \operatorname{Re} z = n\pi, n \in \mathbb{Z}\}$ belongs to $J_0(f)$.

For $z = (x + iy) \in D_+$ we have $f(z) \in D_+$ which implies

$$0 < \sin x \cosh y < \pi.$$

We shall use the above result to show that D_+ is bounded.

LEMMA 4. D_+ is bounded

Proof. We choose Y so that, for $y \geq Y$,

$$\text{i) } \frac{\sinh y}{y} \geq 2\sqrt{2}$$

$$\text{ii) } \frac{\pi}{\cosh y} < \frac{1}{\sqrt{2}} = \sin \frac{\pi}{4}.$$

Then if $|y| > Y$ and $0 < \sin x \cosh y < \pi$, we have $0 < \sin x < \frac{1}{\sqrt{2}}$ so $|\cos x| > \frac{1}{\sqrt{2}}$ and $|\cos x \sinh y| \geq \frac{|\sinh y|}{\sqrt{2}} > 2|y|$.

Now if D_+ contains a point $z = x + iy$ such that $|y| > Y$, then $z_1 = f(z) \in D_+$ and $|y_1| = |\cos x \sinh y| > 2|y|$. By induction $|\operatorname{Im} f^n(z)| > 2^n |y| \rightarrow \infty$ which is impossible. Hence D_+ is indeed bounded.

By symmetry $D_- = -D_+ = D_+ - \pi$ is also bounded.

THEOREM 2.4.1. If $f(z) = \sin z$, then $J_0(f)$ is connected in \mathbb{C} .

Proof. From the periodicity of $f(z)$, each $D_+ + n\pi$ is a component of $F(f)$ ($D_- = D_+ - \pi$).

If $\gamma = \partial D_+$, the union $\Gamma_1 = \cup_{n \in \mathbb{Z}} (\gamma + n\pi)$ is a connected set in $J_0(f)$.

If $\Gamma = \partial D_+ \cup \partial D_-$ then $\cup_{n \in \mathbb{Z}} (D_+ + n\pi) = f^{-1}(D_+ \cup D_-)$ and $\Gamma_1 = f^{-1}(\Gamma)$.

For instance, we have $+1 \in D_+$ and $-1 \in D_-$ and all $\sin^{-1}(\pm 1) = \text{odd multiples of } \frac{\pi}{2}$, which are all in $\cup_{n \in \mathbb{Z}} (D_+ + n\pi)$, so there are no other domains in $f^{-1}(D_+ \cup D_-)$.

We prove the following result by induction.

(1) If $\Gamma_n = f^{-n}(\Gamma)$ and $\widehat{\Gamma}_n$ is the part of Γ_n in the strip K , where $K : 0 < x < \pi, y > 0$, then $\widehat{\Gamma}_n$ is connected and $\widehat{\Gamma}_{n-1} \subset \widehat{\Gamma}_n$.

For $n = 1$, $\widehat{\Gamma}_1 = \partial D_+ \cap K$ and $\widehat{\Gamma}_1 \subset \widehat{\Gamma}_0 = \partial D_+ \cap K$. We now prove the general inductive step.

We define H to be the right half- z -plane slit along $[0,1]$. Let ϕ denote the branch of $\sin^{-1}(z)$ which maps H to the half-strip K . If (1) holds for n then using the symmetry and periodicity of $J_0(f)$ and the fact that it contains all $(n\pi)$, we see that Γ_n is connected and $\Gamma_{n-1} \subset \Gamma_n$. Also we see that $\Gamma_n \cap H$ is connected and $\phi(\Gamma_n \cap H) = \widehat{\Gamma_{n+1}}$ is connected, and $\Gamma_n \subset \Gamma_{n+1}$ implies that $\widehat{\Gamma_n} \subset \widehat{\Gamma_{n+1}}$.

Now (1) shows that Γ_n is connected for all n and is increasing so that $\cup_n \Gamma_n = U$ is also connected. By the invariance of $J_0(f)$ we have $U \subset J_0(f)$.

But taking any point $z_0 \in \Gamma$, preimages of z_0 under $f(z)$ are dense in $J_0(f)$. Thus $U \subset J_0(f) \subset \overline{U}$ and indeed $J_0(f) = \overline{U}$. Hence $J_0(f)$ is connected in \mathbf{C} .

2.5 Buried points of $\sin z$

PROPOSITION 2.5.1. *If $f(z) = \sin z$, then any point $iy \neq 0$ of the imaginary axis is buried.*

Proof. Let G be some component of $F(f)$. If iy is in ∂G , then $f^n(iy) \in \partial f^n(G)$. But, for large n , $f^n(G) = D_+$ or D_- which are bounded components, while $f^n(iy) \rightarrow \infty$. The contradiction proves our result.

Of course $J_0(\sin z)$ has only one component so it is not true that the whole component is buried.

2.6 Multiply-connected components like rings

We may observe: if $J(f)$ (or equivalently $J_0(f)$) has a singleton component $\{\xi\} \neq \infty$ then $F(f)$ has a multiply-connected component. This suggests a question. Is the converse true? The answer is yes and we will prove it later. First we shall give a lemma proved by I.N. Baker [10] about multiply-connected components.

LEMMA 5. *If $f(z)$ is a transcendental entire function and $F(f)$ has a multiply-connected component U , then U and all its iterates are bounded wandering components and $f^n \rightarrow \infty$ in U ($n \rightarrow \infty$). Also there is a simple curve γ in U such that $f^n(\gamma)$ is a curve in $f^n(U) = U_n$ on which $|z|$ is large and which winds round 0.*

Thus U_n also contains a simple curve γ_n whose distance from 0 is large and whose winding number about zero is non-zero.

In the following section we will prove some lemmas which extend the result of Lemma 5.

2.7 Preliminary lemmas

We continue with the assumptions and notation of Lemma 5.

With the above description γ_n is a simple curve in U_n , so this suggests the following lemma.

LEMMA 6. *$f(\gamma_n)$ is in $U_{n+1} \neq U_n$, winds round zero and must be outside γ_n .*

Proof. For otherwise since $f(\gamma_n)$ cannot meet γ_n and has some points inside γ_n we must have $f(\gamma_n)$ all inside γ_n , U_{n+1} all inside γ_n . Now note that the simple curve γ_{n+1} analogous to γ_n , is inside γ_n and $\gamma_{n+1} \subset U_{n+1}$.

Since $f(\text{int } \gamma_{n+1}) \subset f(\text{int } \gamma_n)$ and $\partial f(\text{int } \gamma_n) \subset f(\gamma_n) \subset U_{n+1} \subset \text{int } \gamma_n$, we have $f(\text{int } \gamma_n)$ is inside γ_n . $U_{n+1} \subset \text{int } \gamma_n$ thus $U_{n+2} = f(U_{n+1})$ has some points inside γ_n and U_{n+2} is inside γ_n . Continuing this process by induction we have that all U_{n+k} are inside γ_n which contradicts the fact that $U_n \rightarrow \infty$ as $n \rightarrow \infty$.

LEMMA 7. *There is a component N_n of $F(f)$ between U_n, U_{n+1} and an integer $m > 2$ such that $f^m(N_n) \subset U_n$.*

Proof. It follows from Lemma 6 that each γ_{n+1} is outside γ_n and U_{n+1} is outside U_n . The components U_n look like rings but might have further holes in them to give connectivity ≥ 2 . Thus ∂U_n has an outer component α_n and an inner component β_n , where α_n is the boundary of the component of U_n^c which contains ∞ and β_n is the boundary of the component of U_n^c which contains zero.

Now between α_n and β_{n+1} there are points of $J(f)$. By replacing f by f^3 , which does not change $J(f)$, we may assume that there is a point $\xi \in J(f)$ which is between U_n and U_{n+1} , and such that $\xi \notin \alpha_n \cup \beta_{n+1}$.

Take $\eta \in U_n$ such that η is not a Fatou exceptional point, then there is a sequence $z_{n_k} \rightarrow \xi$ with integers $n_k \rightarrow \infty$ so that $f^{n_k}(z_{n_k}) = \eta$. Thus for large n_k , z_{n_k} is between U_n, U_{n+1} , and thus there is a component N_n of $F(f)$ between U_n, U_{n+1} such that $f^{n_k}(N_n) \subset U_n$. If we write $m = n_k$, then $f^m(N_n) \subset U_n$. See Figure 2.3 where the components U_n are shown schematically as if they were circular annuli. With the above argument we shall prove an important lemma about the component N_n .

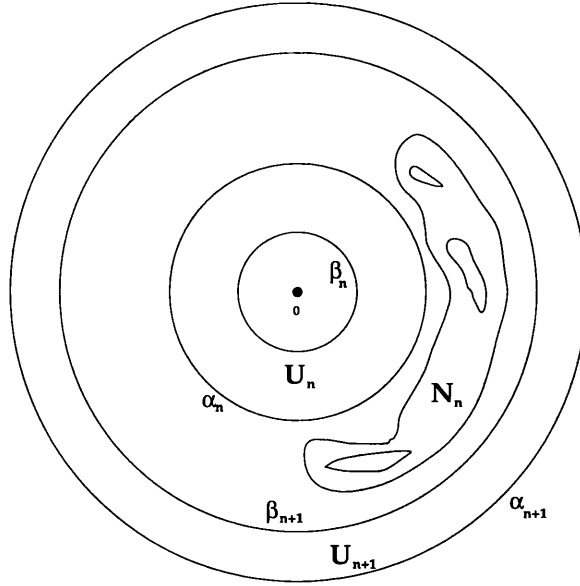

Fig. 2.3: The component N_n of $F(f)$ between U_n and U_{n+1}

LEMMA 8. N_n is a multiply-connected component of $F(f)$.

Proof. We know that $\partial f^m(N_n) \subset f^m(\partial N_n)$ is true for all bounded domains. In our case we also have $\partial f^m(N_n) \supset f^m(\partial N_n)$. In effect we take $w \in f^m(\partial N_n)$ then $w = f^m(z_1)$, $z_1 \in \partial N_n$. Then $z_1 \in J(f)$ which implies $w \in J(f)$. Thus $w \notin f^m(N_n)$. But also there exists a sequence $z_v \in N_n$, such that $z_v \rightarrow z_1$ so $f^m(z_v) \in U_n$ and $f^m(z_v) \rightarrow f^m(z_1) = w$ so $w \in \overline{f^m(N_n)}$. Hence $w \in \partial f^m(N_n)$. Now since $\partial f^m(N_n) = f^m(\partial N_n)$ we have that if ∂N_n is connected ($\Leftrightarrow N_n$ simply-connected), then $f^m(\partial N_n)$ is connected and so $f^m(N_n) = U_n$ is simply-connected which is a contradiction.

One may also derive Lemma 8 from the Riemann-Hurwitz formula.

LEMMA 9. N_n does not wind round zero i.e., zero is in the unbounded component of $\overline{N_n}^c$ for $n \geq n_0$.

Proof. If Lemma 9 is false then $\overline{N_n}^c$ has at least two components, one G , say, containing zero, another, H , unbounded. Now G is simply-connected and ∂G is a continuum. Take $\beta = \partial G$ and α_n as in Lemma 7, so $\partial G \subset \partial N_n \subset J(f)$ then β is outside U_n . Also there exists some m such that $f^m(N_n) \subset U_n$.

We see that $f^m(\beta) \subset f^m(\partial N_n \subset \partial(f^m(N_n))) \subset \partial U_n$ then $f^m(\beta) \subset \partial U_n$ so this is inside or on α_n . Now $G \supset U_n$ so $f^m(G) \supset f^m(U_n) = U_{n+m}$; thus $\partial f^m(G) \subset f^m(\partial G) = f^m(\beta) \subset \partial U_n$ which is inside or in α_n .

Since $f^m(G)$ contains U_{n+m} outside α_n it must contain all points outside α_n . But $f^m(G)$ must be bounded (see Figure 2.3). This contradiction shows that the lemma is valid.

2.8 Proof of the main theorem

We shall need a lemma which was proved by L. Ahlfors [1], see [5] for its use in iteration theory.

LEMMA 10. *Let $f(z)$ be meromorphic in the disc $|z| < R$ and let E_1, \dots, E_5 be simply-connected regions of the w -plane bounded by sectionally analytic Jordan curves and such that the closures of E_i are mutually disjoint. Then there is a constant C which depends only on the regions E_i and not on $f(z)$ such that, provided that*

$$\frac{R|f'(0)|}{1+|f(0)|^2} > C,$$

the disc $|z| < R$ contains a domain which is mapped univalently by $f(z)$ onto one of the E_i .

THEOREM 2.8.1. *If $f(z)$ is a transcendental entire function and $F(f)$ has a multiply-connected component, then $J(f)$ has some single point component $\{\zeta\} \neq \infty$ which is a buried component of $J(f)$. Such points are dense in $J(f)$.*

Proof. Let ξ be any point of $J(f)$ and take a neighbourhood V such that $\xi \in V$. Now pick a repelling periodic point η with period p ($f^p(\eta) = \eta$, $|(f^p)'(\eta)| > 1$). We can assume V to be $D(\eta, R)$ and choose $m \in \mathbb{N}$ so that the spherical derivative of f^{mp} at η is

$$\rho(f^{mp}, \eta) = \frac{|(f^{mp})'(\eta)|}{1+|f^{mp}(\eta)|^2} = \frac{|(f^p)'(\eta)|^m}{1+|\eta|^2},$$

which satisfies $R\rho(f^{mp}, \eta) > C$, where C is a certain constant to be defined below.

Pick N_n as in Lemmas 8 and 9 for five different values of $n = n_i$, write $N_{n_i} = N_i$ and let E_i , $1 \leq i \leq 5$, be simply connected regions of the w -plane with smooth boundary such that $N_i \subset E_i$ and the closures of the E_i are mutually disjoint.

Then it follows from Lemma 10 that there is a C which depends only on the regions E_1, \dots, E_5 and not on $f(z)$ such that $R\rho(f^{mp}, \eta) > C$ implies that the disc $D(\eta, R)$ contains a domain \hat{E} which is mapped by f^{mp} univalently onto one of the E_i .

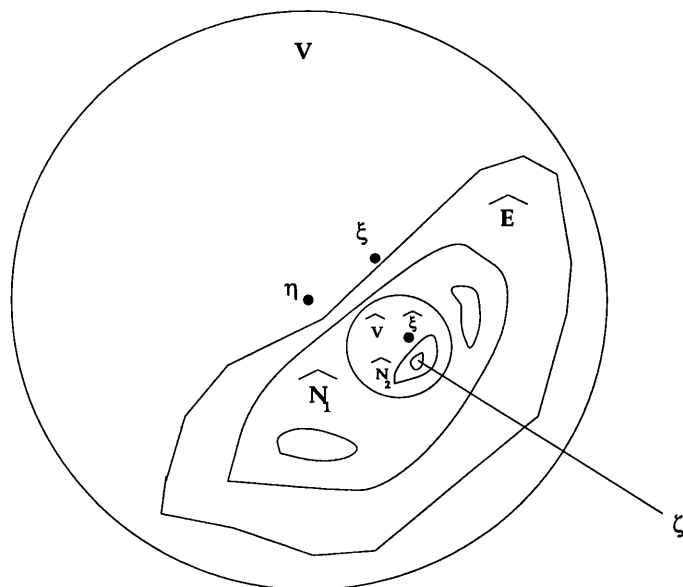

Fig. 2.4: The points $\xi \in V$ and $\hat{\xi} \in \hat{V}$ belong to $J(f)$

In particular f^{mp} maps a subset \hat{N}_1 of \hat{E} univalently onto N_i , and \hat{N}_1 is thus a multiply connected component of $F(f)$ which lies entirely inside V . Now since \hat{N}_1 is multiply-connected, there is some point $\hat{\xi}$ of $J(f)$ which lies inside the outer boundary of \hat{N}_1 .

We repeat the above argument using a neighbourhood \hat{V} of $\hat{\xi}$ so small that \hat{V} is inside the outer boundary of \hat{N}_1 , see Figure 2.4, then \hat{V} contains a multiply-connected component \hat{N}_2 of $F(f)$ which is mapped onto one of the E_i by some $f^{m'p'}$ where we may take the $m'p'$ arbitrarily large, so large that $m'p' > mp$ ($\hat{N}_2 \neq \hat{N}_1$ because N_n are wandering domains).

Thus \hat{N}_2 is inside one of the inner boundary components of \hat{N}_1 , so we obtain inductively a sequence of different multiply-connected components \hat{N}_k of $F(f)$ with $\text{diam}(\hat{N}_k) \rightarrow 0$ and \hat{N}_{k+1} is inside one of the inner boundary components of \hat{N}_k . A sequence $\xi_k \in \partial(\hat{N}_k)$ is a Cauchy sequence which converges to a point $\zeta \in J(f)$.

Clearly, by the construction, ζ is a buried component of $J(f)$.

C H A P T E R 3

Self-maps of the punctured plane

3.1 Introduction to Chapter 3

Let f be a non-Möbius analytic self-map of \mathbf{C}_* . Write $J_*(f)$ for the Julia set of f in \mathbf{C}_* and $J(f)$ for the closure of $J_*(f)$ in $\widehat{\mathbf{C}}$. Then we have one of the three cases (i) $J(f)$, $J_*(f)$ are connected, (ii) $J(f)$ is connected, $J_*(f)$ has infinitely many components, (iii) $J(f)$ has two components, $J_*(f)$ has infinitely many components. All three cases can occur.

It is known that $F(f)$ has at most one multiply-connected domain A whose connectivity must in fact be two. If in addition A is relatively compact in \mathbf{C}_* , then either

- (i) A is a Herman ring,
- (ii) A is pre-periodic but not periodic, or
- (iii) A is a wandering component.

Example of all three cases are constructed.

Let $f(z)$ be an analytic self-map of a domain D of $\widehat{\mathbf{C}}$. Complex dynamics studies the Fatou set, $F(f)$, which is defined as the maximal open subset of D where the iterates $\{f^n\}$ of $f(z)$ form a normal family. The complement of $F(f)$ is the Julia set. By Montel's theorem the theory is trivial unless the complement of D contains fewer than three points. We may therefore consider the cases I. $D = \widehat{\mathbf{C}}$, $f(z)$ rational, II. $D = \mathbf{C}$, $f(z)$ entire, and III. $D = \mathbf{C}_* = \{z : 0 < |z| < \infty\}$. Case I has been well studied, see e.g. the book [20]. Case II was first studied by Fatou [40] in 1926, see e.g. [21] for a survey. Case III was first studied by Rådström [67] in 1953 and then by P. Bhattacharyya [25] and later by e.g. [12, 36, 37, 38, 48, 49, 51, 52, 55, 56, 58]

Throughout the chapter we shall exclude the possibility that $f(z)$ is a constant or a Möbius transformation. Then, provided we make the normalisation that if $f(z)$ has just one essential singularity this is at ∞ , we have the following cases for $f(z)$.

- (a) $f(z) = kz^n$, $k \neq 0$, $n \in \mathbf{Z}$, $n \neq 0, \pm 1$,
- (b) $f(z) = z^n \exp(g(z))$, $g(z)$ non-constant entire, $n \in \mathbf{N} \cup \{0\}$,
- (c) $f(z) = z^{-n} \exp(g(z))$, $g(z)$ non-constant entire, $n \in \mathbf{N}$,
- (d) $f(z) = z^m \exp\{g(z) + h(\frac{1}{z})\}$, $g(z), h(z)$ non-constant entire functions, $m \in \mathbf{Z}$.

To emphasize that we are working in \mathbf{C}_* we shall write $J_*(f)$ (which of course is a subset of \mathbf{C}_*) for the Julia set of $f(z)$. We write $J_0(f)$ for the Julia set of an entire function in \mathbf{C} and $J(f)$ for the closure of $J_*(f)$ or $J_0(f)$ in $\widehat{\mathbf{C}}$.

Given an analytic self-map $f(z)$ of \mathbf{C}_* and $\pi(z) = \exp(z)$ or $\exp(iz)$, there exists an entire function $g(z)$ such that the diagram

$$\begin{array}{ccc}
 & g & \\
 \mathbf{C} & \longrightarrow & \mathbf{C} \\
 \pi \downarrow & & \downarrow \pi \\
 & f & \\
 \mathbf{C}_* & \longrightarrow & \mathbf{C}_*
 \end{array} \tag{3.1}$$

commutes. It was shown by Bergweiler [22] that, provided $f(z)$ is not linear or constant, so provided $g(z)$ is not of the form $g(z) = kz^n$, $k \neq 0$, $n \in \mathbf{Z}$, we have

$$\pi J_0(g) = J_*(f). \tag{3.2}$$

The principle has been asserted by various authors but the first rigorous proof valid in this generality appears to be that of Bergweiler.

We note that if $\pi(z) = \exp(z)$ the function $g(z)$ in (3.1) has the property $g(z+2\pi i) = g(z) + 2\pi mi$ for some integer m .

In view of (3.1) and (3.2) it is not surprising that the dynamics of $f(z)$ has similar properties to the entire case. We mention the following, first proved directly by Rådström [67] or Bhattacharyya [25].

(A) $J_*(f)$ is a (non-empty) perfect set in \mathbf{C}_* . It is completely invariant (that is $f(z) \in J_*(f)$ if and only if $z \in J_*(f)$). For $p \in \mathbf{N}$, $J_*(f^p) = J_*(f)$.

(B) Repelling periodic points are dense in $J_*(f)$.

(C) If Δ is an open set which meets $J_*(f)$ and K is any compact subset of \mathbf{C}_* , then there is a natural number n_0 such that for $n > n_0$ we have $f^{n_0}(\Delta) \supset K$.

Concerning components of the Fatou set we have the following theorem given by I.N. Baker [12].

THEOREM 3.1.1. *If $f(z)$ is a (non-Möbius) analytic map of \mathbf{C}_* to itself, then the components of $F(f)$ are simply or doubly-connected. There is at most one doubly-connected component, (which must separate 0 from ∞) except in the simple case when $f(z)$ has the form $f(z) = kz^n$, $k \neq 0$, $n \in \mathbf{Z}$, $n \neq 0, \pm 1$.*

For $f(z) = kz^n$ it is clear that $J_*(f)$ is the circumference $|z| = k^{\frac{-1}{(n-1)}}$ and $F(f)$ has two components, each a punctured disc.

Since Theorem 3.1.1 is basic to our results, for completeness we give in Section 3.2 a proof which is just a little simpler than that given in Section 3 of [12].

We study the connectivity of the Julia set in Section 3.3 and prove the following results.

THEOREM 3.1.2. *If $f(z)$ is a transcendental map of $\mathbf{C}_* \rightarrow \mathbf{C}_*$, then $J_*(f)$ has no component A compact in \mathbf{C}_* ; in particular $J_*(f)$ has no singleton component.*

We remark that this contrasts with the entire case where it is indeed possible that for an entire function $h(z)$ singleton components are dense in the Julia set of $h(z)$, see Chapter 2, Section 2.8.

Concerning the number of components of $J(f)$, we have that $J(f)$ has either one or two components, each of which contains 0 or ∞ , except in the trivial case $f(z) = kz^n$.

THEOREM 3.1.3. *If $f(z)$ is an analytic self-map of \mathbf{C}_* , then $J_*(f)$ has either one or infinitely many components.*

COROLLARY. *If $J(f)$ has two components, then $J_*(f)$ has infinitely many components.*

Also in Section 3.3 we see that there are only three possible cases for the connectivity of $J(f)$, $J_*(f)$:

- (1) $J(f)$, $J_*(f)$ are both connected,
- (2) $J(f)$ is connected, $J_*(f)$ has infinitely many components,
- (3) $J(f)$ has two components, $J_*(f)$ has infinitely many components,

and we give some examples of the three cases.

A component (or a point) of $J_*(f)$ is ‘buried’ if it does not meet the boundary of any component of $F(f)$. In Section 3.4 we give some examples when buried components and buried points occur for $J_*(f)$. These examples are based on Chapter 2.

A component G of $F(f)$ maps under $f(z)$ to another component. If $f^m(G) \neq f^n(G)$ for all $m \neq n \in \mathbb{N}$ we say that G is wandering. Otherwise G is preperiodic or periodic. It was shown in [12] that wandering components can occur. On the other hand, several authors [9, 10, 11, 34, 46, 67] have shown that Sullivan's theorem may be extended to a class of maps of \mathbb{C}_* : if the inverse function f^{-1} of $f(z)$ has singularities over at most finitely many points then $F(f)$ contains no wandering domains.

The behaviour of the sequence of iterates in a periodic component of $F(f)$ has the same range of possibilities as for general meromorphic functions, that is, the cases which arise from either rational or entire maps. Without loss of generality we may consider an invariant component G . This may be either a Siegel disc, a Herman ring, or the iterates may converge to a constant α , which is an attracting fixed point if $\alpha \in G$, is a parabolic fixed point with $f'(\alpha) = 1$ if $\alpha \in \partial G \setminus \{0, \infty\}$, or may be 0 or ∞ . See e.g. [21].

In Section 3.5 we consider the orbit of the unique doubly-connected component A (if there is one) and discuss the possibilities for A and its orbit. In examples given by I.N. Baker [12] and A.N. Mukhamedshin [58] it is not clear whether the ring A has 0, ∞ in its boundary. Concerning ring domains we prove the following theorem.

THEOREM 3.1.4. *If A is a doubly-connected component of $F(f)$ for a self-map $f(z)$ of \mathbb{C}_* and A is relatively compact in \mathbb{C}_* , then either*

- (i) *A is a Herman ring,*
- (ii) *A is pre-periodic but not periodic, or*
- (iii) *A is a wandering component.*

In cases (ii) and (iii) all $f^n(A)$ are relatively compact simply-connected components.

Examples of all three cases occur and we use Runge's theorem and complex approximation theory to prove Theorem 3.1.5 in Section 3.6.

THEOREM 3.1.5. *There is an analytic self-map $f(z)$ of \mathbb{C}_* such that $F(f)$ contains a relatively compact doubly-connected component A , bounded by two Jordan curves in \mathbb{C}_* , and a simply-connected component G , bounded by a Jordan curve. Moreover G contains an attracting fixed point, $f(G) \subset G$ and $f(A) = G$. Thus A is preperiodic but not periodic.*

In particular there are a constant k and a polynomial $g(z)$ such that $f(z) = \exp\{4\epsilon(z + z^{-1}) + k + g(z)\}$ has the properties listed in Theorem 3.1.5 for some small $\epsilon > 0$. Thus we get an example of case (ii).

In Section 3.7 we use stronger approximation theorems to give an example of case (iii).

THEOREM 3.1.6. *There is an analytic self-map $f(z)$ of \mathbf{C}_* such that $F(f)$ contains a relatively compact doubly-connected component A and a relatively compact simply-connected component G , such that G is a wandering component in which $f^n \rightarrow \infty$, and $f(A) = G$.*

In Section 3.8 the case (i) is covered by the following theorem. The argument is given in a manuscript of M.R. Herman [47] who describes it as a generalisation of a construction of E. Ghys. He constructs a rational function but the method is equally applicable to transcendental functions.

THEOREM 3.1.7. *There is an analytic transcendental self-map $f(z)$ of \mathbf{C}_* such that $F(f)$ has a relatively compact doubly-connected component A which is a Herman ring, whose boundaries are quasicircles in \mathbf{C}_* .*

In Section 3.9 we discuss examples of a doubly-connected component A which extends to 0 and ∞ .

3.2 Components of the Fatou set

For completeness we shall give the proof of the following lemmas. The proof of 11 and 12 differs somewhat from that given in [12]. Together these lemmas imply Theorem 3.1.1.

LEMMA 11. *Suppose that $f(z) \neq kz^n$ is an analytic self-map of \mathbf{C}_* and that G is a component of $F(f)$. Then if γ is a simple closed curve in G , either (i) γ separates $0, \infty$ or (ii) the complement of γ has a relatively compact component which belongs to G .*

Proof. Suppose that neither (i) nor (ii) holds. Thus γ is a simple closed curve in G such that $\mathbf{C}_* \setminus \gamma$ has a component Δ , with $\bar{\Delta}$ compact in \mathbf{C}_* , which meets $J_*(f)$. Then $f^n(\Delta)$ covers any compact part of \mathbf{C}_* for $n > n_0$.

Let f^{n_k} be uniformly convergent on γ . Since $f^n \neq 0, \infty$ in G , it follows from Hurwitz's theorem that the limit function ϕ is either (a) never equal to $0, \infty$ in G or (b) a constant. In case (a) $\phi(\gamma)$ is bounded away from $0, \infty$ which contradicts the above statement about $f^n(\Delta)$, since $\partial(f^n(\Delta)) \subset f^n(\gamma)$. Case (b) also gives a contradiction since $\partial(f^n(\Delta))$ contains points near both $0, \infty$.

COROLLARY. Any component of $F(f)$ is either simply or doubly-connected.

LEMMA 12. Suppose that $f(z)$ is an analytic self-map of \mathbf{C}_* and γ_1, γ_2 are disjoint Jordan curves in $F(f)$, which separate $0, \infty$. Then the region Δ bounded by γ_1, γ_2 contains no points of $J_*(f)$ except in the case when $f(z)$ has the form $f(z) = kz^n$.

Proof. Suppose that Δ meets $J_*(f)$. Let $n_k \rightarrow \infty$ be such that f^{n_k} converges uniformly with limit ϕ on γ_1, γ_2 . Then it follows from Hurwitz's theorem that $\phi(\gamma_i)$, $i = 1, 2$, is either a compact subset of \mathbf{C}_* or a constant (0 or ∞). Since $\partial(f^{n_k}(\Delta)) \subset f^{n_k}(\gamma_1 \cup \gamma_2)$ and $f^n(\Delta)$ covers all but an arbitrarily small spherical neighbourhood of $0, \infty$ for $n > n_0$, we see that $\{0, \infty\} \subset \phi(\gamma_1 \cup \gamma_2)$, $\phi = 0$ on one γ_i and ∞ on the other. Hence γ_1, γ_2 are in different components of $F(f)$, separated by $\Delta \cap J_*(f)$.

Let A, B denote the components of $(\Delta \cap J_*(f))^c$ which contain 0 and ∞ respectively. The boundary of $f^{n_k}(\Delta)$ contains a closed curve $\gamma_k \subset (f^{n_k}(\gamma_1) \cup f^{n_k}(\gamma_2))$ which lies close to ∞ and separates $0, \infty$. Thus γ_k belongs to $F(f)$ and $\gamma_k \subset B$. The image $f(\gamma_k)$ is connected, lies in $F(f)$ and so does not meet $\Delta \cap J_*(f)$. So $f(\gamma_k)$ stays in one component of $(\Delta \cap J(f))^c$. Thus it cannot meet both A, B .

Then there exists $\epsilon > 0$ such that A contains an ϵ -neighbourhood of 0 and B contains an ϵ -neighbourhood of ∞ , therefore $f(\gamma_k)$ cannot meet both of these neighbourhoods.

On γ_k either (i) $|f(z)|$ is bounded ($|f(z)| < K(\epsilon)$) if $f(\gamma_k)$ does not meet an ϵ -neighbourhood of ∞ , or (ii) $|f(z)| > \delta(\epsilon) > 0$ in the case when $f(\gamma_k)$ does not meet an ϵ -neighbourhood of 0 . If (i) holds for infinitely many γ_k , then applying the maximum principle to $f(z)$ between different γ_k and nothing that $\gamma_k \rightarrow \infty$ we see that $f(z)$ is bounded in a neighbourhood of ∞ . If (ii) holds for infinitely many k then $\frac{1}{f(z)}$ is bounded in a neighbourhood of ∞ . In either case ∞ cannot be an essential singularity of $f(z)$.

A similar argument about the part of $\partial f^{n_k}(\Delta)$ near 0 shows that 0 is not an essential singularity of $f(z)$. But this is possible only in the case $f(z) = kz^n$.

3.3 Connectivity of the Julia set

We begin this section with a topological lemma.

LEMMA 13. If A is a closed set in \mathbf{C}_* with a component K which lies in $0 < \epsilon < |z| < \frac{1}{\epsilon} < \infty$ then K is a component of $A \cup \{0, \infty\}$ in $\widehat{\mathbf{C}}$.

We omit the proof which follows easily from e.g. Exercise 4 in [73, p.38].

Proof of Theorem 3.1.2

Proof. Suppose that A is a component of $J_*(f)$ which is compact in \mathbf{C}_* . Therefore it follows from Lemma 13 that A is a component of $J_*(f) \cup \{0, \infty\}$ and also a component of $J(f)$. We may assume ∞ is an essential singularity of $f(z)$, so $J_*(f)$ has ∞ as a limit point and $\infty \in J(f)$.

Now let K be the component of $J(f)$ which contains ∞ . Then (see e.g. [60, p.143]) there exists a polygon γ in $J(f)^c$ which separates A and K and we can assume that 0 does not belong to γ . So, γ is a closed polygon (which we can suppose simple) in $F(f)$. Then in Lemma 11 case (ii) cannot hold so by (i), γ separates 0 from ∞ .

Let G be the component of $F(f)$ which contains γ . We know that γ divides $\widehat{\mathbf{C}}$ into two components, one of which contains K and the other contains A . Thus γ cannot be deformed to a point in $F(f)$, so G is multiply-connected, and in fact G is doubly-connected. There exists only one multiply-connected component of $F(f)$.

By [10] if $f(z)$ is a transcendental entire function and $F(f)$ has a multiply-connected component then there are infinitely many such components. Thus $z = 0$ is either a pole or an essential singularity of $f(z)$. Then $J(f)$ has zero as a limit point (invariance of $J(f)$).

If L is a component of $J(f)$ which contains zero then there exists polygon Γ in $F(f)$ which separates L from A and so by Lemma 11, separates 0 from ∞ . Now γ and Γ cannot be in the same component, say G , of $F(f)$ for, were this the case, G^c would have at least three components one containing 0 , one ∞ , and one A . Thus γ and Γ are in disjoint components of $F(f)$. But by Lemma 12, this gives a contradiction. The proof is complete.

Theorem 3.1.2 shows that $J(f)$ has either one or two components, each of which must contain either zero or ∞ .

We now consider the number of components of $J(f)$ and $J_*(f)$. Since case (a) of the introduction is so simple we consider only transcendental $f(z)$.

LEMMA 14. $f(z)$ maps each component K of $J_*(f)$ into a component of $J_*(f)$.

Proof. The function $f(z)$ is continuous in \mathbf{C}_* so $f(K)$ is connected in \mathbf{C}_* and belongs to $J_*(f)$ by the invariance property.

Proof of Theorem 3.1.3

Proof. Suppose that $J_*(f)$ has altogether some finite number k of components K_1, K_2, \dots, K_k , $k > 1$. It follows from Lemma 14 and the fact that $f(z)$ maps \mathbf{C}_* onto \mathbf{C}_* that $f(z)$ must permute the components K_i of the completely invariant set $J_*(f)$. Since we may replace $f(z)$ by a higher iterate and have always $J_*(f) = J_*(f^n)$ we may assume that $f(z)$ fixes each K_i .

Now let $G = \mathbf{C}_* \setminus K_1$. This is an invariant open set $f(G) \subset G$. Hence $G \subset F(f)$. But this contradicts the fact that $K_2 \subset G$, $K_2 \subset J_*(f)$. The proof is complete.

We prove the corollary of Theorem 3.1.3:

If $J(f)$ has two components, then $J_(f)$ has infinitely many components.*

For $J(f) = A_1 \cup A_2$ where A_1 and A_2 are closed and disjoint in $\widehat{\mathbf{C}}$, $0 \in A_1$, $\infty \in A_2$ and neither A_i is a singleton, since $J_*(f)$ and $J(f)$ are perfect. Thus $J_*(f) = (A_1 \cap \mathbf{C}_*) \cup (A_2 \cap \mathbf{C}_*)$ shows that $J_*(f)$ is disconnected.

We obviously have the following lemma.

LEMMA 15. *There are only three possible cases for the connectivity of $J(f)$, $J_*(f)$:*

- (1) $J(f)$, $J_*(f)$ are connected,
- (2) $J(f)$ is connected, $J_*(f)$ has infinitely many components,
- (3) $J(f)$ has two components, $J_*(f)$ has infinitely many components.

We give examples of the above cases.

Case (1) occurs for $f(z) = kz^n$ when $J(f) = J_*(f)$. To obtain a transcendental example take the function

$$g(z) = \sin z = \left(\frac{e^{iz} - e^{-iz}}{2i} \right).$$

Using Bergweiler's theorem, quoted in the introduction, we take $\pi(z) = e^{iz}$ and obtain

$$f(t) = e^{\frac{t-t^{-1}}{2}}, \quad t = e^{iz} : \mathbf{C}_* \rightarrow \mathbf{C}_*$$

as a projection of $g(z)$ to \mathbf{C}_* .

It was shown for example in Chapter 2, Section 2.4, that $J_0(\sin z)$ is connected (in \mathbf{C}) and so $J_*(f) = \pi J_0(\sin z)$ is connected in \mathbf{C}_* .

Case (2). It is well known (see e.g. [18]) that if $a = te^{-t}$, $0 < t < 1$ ($0 < a < \frac{1}{e}$), the entire function $f(z) = e^{az}$ has a connected Fatou set in which $f^n(z)$ converges to the attracting fixed point e^t (for which $f'(e^t) = t$). Thus $J(f)$, the boundary of $F(f)$, is connected in $\widehat{\mathbf{C}}$. On the other hand it is easily seen that the real interval $(-\infty, 0) \subset F(f)$ while $(b, \infty) \in J_*(f)$ for some $b > 0$. Since $f(z)$ has period $\frac{2\pi i}{a}$ it follows that all translates of (b, ∞) by multiples of $\frac{2\pi i}{a}$ are in $J_*(f)$. However, the lines $\text{Im}z = \frac{\pi i(2n+1)}{a}$, $n \in \mathbf{Z}$, map into $(-\infty, 0) \subset F(f)$ and therefore belong to $F(f)$. Clearly $J_*(f)$ is not connected. In this special case the components of $J_*(f)$ form a ‘Cantor bouquet’ as investigated by Devaney and Goldberg [30].

Case (3). We need only assure that $J(f)$ is not connected.

In our discussion of case (1) we may replace $g(z)$ by $h(z) = \frac{1}{2} \sin z$ for which the whole real axis $\mathbf{R} \subset F(h)$, since it lies in the basin of attraction of $z = 0$. Further $J_0(h)$ is symmetric under reflection in \mathbf{R} . It follows from Bergweiler’s result that for

$$f(t) = e^{\frac{t-t^{-1}}{4}}$$

the unit circumference is in $F(f)$ and separates (at least) two components of $J(f)$.

3.4 Buried points and buried components

In Chapter 2 (see also [66]) a study was made of buried points and components of the Julia set of an entire function. In the present context we define for maps $f(z)$ of \mathbf{C}_* to \mathbf{C}_* that a component of $J_*(f)$ is buried if it does not meet the boundary of any component of $F(f)$. Similarly a point of $J_*(f)$ is buried if it is not in the boundary of any component of $F(f)$. This is a stronger property than merely requiring that a point of a closed set be inaccessible from all components of its complement.

Examples of buried components occur: Let λ be any value such that $f(z) = e^{\lambda z}$ has an attracting cycle of some order. Then 0 is the basin of this cycle and so in $F(f)$. Thus $J_0(f) = J_*(f)$. It was shown in Chapter 2, Section 2.3, that $J_0(f)$ and hence also $J_*(f)$ has a buried component.

For the function $g(z) = \sin z$, it was shown in Chapter 2, Section 2.5, that every point except 0 on the imaginary axis is a buried point of $J_0(g)$. By Bergweiler's result every point of the positive real axis, except $t = 1$ is a buried point of $J_*(\tilde{f})$ where

$$\tilde{f}(t) = e^{\frac{t-t^{-1}}{2}}.$$

Since $J_*(\tilde{f})$ is connected, there is of course no buried component in this case.

3.5 The doubly-connected component

Let D be a connected component of $F(f)$. We say that D is pre-periodic if there exist integers p and q such that $f^{p+q}(D) = f^p(D)$, it is periodic if $f^q(D) = D$ for some $q \in \mathbf{Z}$. A component which is neither periodic nor pre-periodic is wandering.

The uniqueness of the doubly-connected component A (if it exists) makes it interesting to discuss the possibilities for A and its orbit. We list some examples, see [12] for 1 and 2.

Example 1. For $0 < \alpha < \frac{1}{2}$ and $f(z) = e^{\alpha(z-z^{-1})}$, $F(f)$ is a single (hence completely invariant) domain A , which contains the unit circumference, in which f^n converges to the attracting fixed point 1. Since $0, \infty \in J(f)$ the domain A is doubly-connected and $0, \infty$ belong to \bar{A} .

Example 2. For $0 < \alpha < \frac{1}{2}$ we may choose β so that $g(z) = e^{2\pi i \beta} z e^{\alpha(z-z^{-1})}$ has a Herman ring component A of $F(f)$ which includes the unit circumference, and in which $g(z)$ is analytically conjugate to a rotation about 0, thus through an irrational multiple of π .

There are certainly other components of $F(f)$ in this case. There was no discussion as to whether the ring A is bounded away from 0 and ∞ .

Example 3. (A.N Mukhamedshin [58]) There exists a map $f(z)$ of \mathbf{C}_* to itself with a Herman ring A and wandering components, one of which wanders toward $z = 0$ and the other toward $z = \infty$.

The proof is by a combination of approximation theory and quasiconformal surgery. Again it is not clear whether the ring A has $0, \infty$ in its boundary.

Lemma 3.3 in [48] asserts that if A is a doubly-connected component of $F(f)$ which

is bounded away from 0, ∞ , that is, if \bar{A} is compact in \mathbf{C}_* , then A is either a wandering domain with limit functions 0 and/or ∞ , or a Herman ring. It also asserts that if A is wandering its iterates are annuli separating 0 and ∞ . We shall now prove Theorem 3.1.4, which differs somewhat from the preceding statement.

Proof of Theorem 3.1.4

Suppose that A is a doubly-connected component of $F(f)$, where $f(z)$ is a self-map of \mathbf{C}_* and \bar{A} is compact in \mathbf{C}_* . As argued in [48], if $f(A)$ meets A then $f(z) : A \rightarrow A$ is an unbranched cover by the Riemann-Hurwitz relation. Moreover the map $f(z)$ is homomorphism since A and $f(A)$ have the same modulus. Thus f/A is conjugate to a rotation, necessarily through an irrational multiple of π , since no iterate of $f(z)$ can be the identity. Hence in this case we have a Herman ring.

If $f(A) \neq A$ then all $f^n(A)$ are compact for $n \geq 1$ and also simply-connected so A cannot be periodic. This is clear for $n = 1$ and follows by induction for all $n \geq 2$, since $\partial f^{n-1}(A)$ is connected and maps by f onto $\partial f^n(A)$. Thus here remain only the possibilities (ii) and (iii). Hence A is either wandering or preperiodic but not periodic.

3.6 Proof of Theorem 3.1.5

LEMMA 16 (Runge's theorem [41]). *If $K \subset \mathbf{C}$ is compact, $K^c = \mathbf{C} \setminus K$ is connected and $f(z)$ is analytic on K , then there exist polynomials P_n such that $\max|f(z) - P_n| \rightarrow 0$ as $n \rightarrow \infty$.*

Proof of Theorem 3.1.5

Let $h(z) = 4\epsilon(z + z^{-1})$, $\epsilon > 0$, and let B denote the annulus which is defined by $B = \{z : \frac{1}{4} \leq |z| \leq 4\}$. Then $h(z)$ maps B to an ellipse whose semi-major axis is $[0, 17\epsilon]$ and whose semi-minor axis is $[0, 15\epsilon i]$, and maps the unit circle to the segment $[-8\epsilon, 8\epsilon]$. We choose $\epsilon > 0$ so small that $e^{h(z)}$ maps B onto a region which includes $D(1, 14\epsilon)$ and lies inside $D(1, 18\epsilon)$, it maps the unit circle onto a subset of $[1 - 9\epsilon, 1 + 9\epsilon]$. Moreover we may assume e^w univalent for $w \in h(B)$.

Now choose k so that $e^k > 10$ and $10e^k\epsilon = 1$. We may certainly suppose that ϵ has been chosen so small that this is possible, and thus that $\epsilon < 0.01$.

Let S be the closed disc $\overline{D}(0, 4)$, $T = \overline{D}(e^k, 2)$. In Runge's theorem we take $K = S \cup T$ and find a polynomial $g(z)$ such that

$$|g(z)| < \delta \text{ in } S, \quad (3.3)$$

$$|g(z) + h(z) - \log\{1 + e^{-k}(z - e^k)^2\}| < \delta \text{ in } T, \quad (3.4)$$

where δ has been chosen so small that

$$4\delta e^k < \epsilon \text{ and } e^\delta - 1 < 2\delta. \quad (3.5)$$

The function $f(z) = \exp\{h(z) + k + g(z)\}$ maps \mathbf{C}_* to \mathbf{C}_* . For all $z \in B \subset S$ we have, from (3.3) and (3.5), that

$$\begin{aligned} |f(z) - \exp\{h(z) + k\}| &= |e^{h(z)+k}(e^{g(z)} - 1)| \\ &\leq (e^k + 18\epsilon e^k)(e^\delta - 1) < 4e^k\delta < \epsilon. \end{aligned} \quad (3.6)$$

For all $z \in T$ we have, from (3.4) and (3.5), that

$$\begin{aligned} &|f(z) - \{e^k + (z - e^k)^2\}| \\ &= |e^k + (z - e^k)^2| |\exp\{g(z) + h(z) - \log(1 + e^{-k}(z - e^k)^2)\} - 1| \\ &\leq (e^k + 4)(e^\delta - 1) \leq 4e^k\delta < \epsilon. \end{aligned} \quad (3.7)$$

Thus $f(z)$ maps the unit circumference to a set whose distance from the segment $e^k(1 \pm 9\epsilon)$ never exceeds ϵ (by (3.6)) and so the image lies inside $D(e^k, 0.95) = \Delta$, since $9\epsilon e^k + \epsilon < 9.5\epsilon e^k = 0.95$. But $f(\Delta)$ is a relatively compact subset of Δ , since by (3.7) $f(\Delta)$ lies inside a disc whose centre is e^k and radius $\leq (\frac{19}{20})^2 + \epsilon < 0.95$ since $\epsilon < 0.01$. Thus Δ belongs to a component G of $F(f)$ which contains an attracting fixed point α in Δ .

By a similar calculation $f(z)$ maps each point of the circle $C(e^k, 1.1)$ to a point outside the circle. If G meets this circle then there is a compact set γ joining α with a point of $C(e^k, 1.1)$ inside G . But for all $n \geq 1$ the set $f^n(\gamma)$ must contain both α and points outside the circle. This conflicts with the fact that $f^n \rightarrow \alpha$ uniformly on γ . Hence G lies inside $C(e^k, 1.1)$ and is a bounded simply-connected component of $F(f)$.

In fact we have here an example of the polynomial-like mappings of A. Douady and J.H. Hubbard [32]. Since $|f(z) - e^k| > 2$ for $z \in C(e^k, \frac{3}{2})$, we see that there is a component U' of $\{z : |f(z) - e^k| < \frac{3}{2}\}$ which lies inside $U = D(e^k, \frac{3}{2})$, is bounded by

a level curve $\{z : |f(z) - e^k| = \frac{3}{2}\}$, and contains $D(e^k, 1)$ in its interior. The function $f(z)$ maps U' onto U , the component U' is relatively compact in U , and $f(z)$ is a proper mapping of degree 2, for example by Rouché's theorem.

If we restrict consideration of $f(z)$ entirely to its action $f(z) : U' \rightarrow U$ we denote $K_f = \bigcap_{n \geq 0} f^{-n}(U')$, that is the points of U' whose orbits always remain in U' . Clearly $K_f \supset \overline{G}$.

By [32] there exists a polynomial P of degree 2 and a quasiconformal homeomorphism ϕ of a neighbourhood of K_f to a neighbourhood of the filled Julia set K_P such that $\phi f = P\phi$. Then $\phi(\alpha)$ is an attracting fixed point of P and $\phi(G)$ its immediate domain of attraction. But for a quadratic polynomial with an attracting fixed point the boundary of the domain of attraction is a Jordan curve, say Γ' . Thus the boundary of G is a Jordan curve $\phi^{-1}(\Gamma') = \Gamma$.

Now we recall that $f(z)$ maps the unit circumference σ into $\Delta \subset G$. Thus σ is part of a doubly-connected component A of $F(f)$ such that $f(A) \subset G$. Now $f(\partial B)$ is outside $D(e^k, 13\epsilon e^k)$ and thus outside G . Hence A is a relatively compact subset of B , with two boundary components γ_1, γ_2 . Each component γ_i is mapped by $f(z)$ into Γ . The map $f(z) : A \rightarrow G$ is a branched cover which takes each value just twice. It follows from this that the map $f(z) : \gamma_i \rightarrow \Gamma$ is one to one in each case. Since $f(z)$ is continuous it is then a homomorphism and each γ_i is a Jordan curve. Thus the Theorem 3.1.5 is proved.

3.7 Proof of Theorem 3.1.6

For the proof of Theorem 3.1.6 we need a more powerful result on approximation.

LEMMA 17 (Nersesjan's theorem [41]). *Suppose that F is a closed proper subset of \mathbf{C} . Then F is a Carleman set in \mathbf{C} if and only if it satisfies the conditions*

1. $\widehat{\mathbf{C}} \setminus F$ is connected.
2. $\widehat{\mathbf{C}} \setminus F$ is locally connected at ∞ .
3. For every compact subset K of \mathbf{C} there is a neighbourhood V of ∞ in $\widehat{\mathbf{C}}$ such that no component of $\overset{\circ}{F}$ intersects both K and V .

The statement that F is a Carleman set in \mathbf{C} means that for every function $f(z)$, which is analytic in $\overset{\circ}{F}$ and continuous in F , and for every continuous positive error function $\epsilon(z)$ on F there is an entire function E such that $|f(z) - E(z)| < \epsilon(z)$ for all z in F .

Proof of Theorem 3.1.6

(a) We shall construct

$$f(z) = \exp\{h(z) + k + g(z)\}, \quad h(z) = 4\epsilon(z + z^{-1}), \quad \epsilon > 0,$$

as in Theorem 3.1.5 but with $g(z)$ now an entire function.

As in the preceding proof we let B denote the annulus $B = \{z : \frac{1}{4} \leq |z| \leq 4\}$ and choose $h(z)$, ϵ , k and δ as before in the first two paragraphs plus (3.5).

We let $K_1 = e^k$ (recall $e^k > 10$) and define K_n so that $K_{n+1} - K_n \geq 4$, $n \in \mathbb{N}$. We choose numbers λ_n , μ_n , ϵ_n , and η_n , with $n \in \mathbb{N}$, so that $\epsilon_n > 0$, $\eta_n > 0$, $\mu_n > 1$, $\lambda_n > 1$, where λ_n is strictly decreasing to one and

$$(\lambda_1 + 2\epsilon_1) \prod_1^{\infty} \lambda_n < 1.01, \quad (3.8)$$

$$2\epsilon_n < \lambda_n(\mu_n - 1), \quad (3.9)$$

$$\lambda_{n-1} - \lambda_n > 2\epsilon_n, \quad \lambda_n - \lambda_{n+1} > 2\epsilon_n, \quad (3.10)$$

$$1 < \mu_n < \lambda_n, \quad (3.11)$$

$$\eta_n / (\lambda_{n+1} - \mu_{n+1}) \rightarrow 0 \text{ as } n \rightarrow \infty. \quad (3.12)$$

This is clearly possible. We could start with $\lambda_n = 1 + 2^{-(n+n_0)}$ for sufficiently large n_0 and achieve (3.8) with sufficiently small ϵ_1 . Then pick μ_n to fulfill (3.11), ϵ_n to fulfill (3.9) and (3.10) and finally η_n .

Write $S = \overline{D}(0, 4)$, $\overline{D}_0 = \overline{D}(6, 1)$, $\overline{D}_n = \overline{D}(K_n, \mu_n)$, and $\Delta_n = D(K_n, 1)$. Let Γ_n be the circular arc $\Gamma_n = \{z : |z| = \lambda'_n, |\arg z| \geq \eta_n\}$, where

$$\lambda'_n = (\lambda_n + \mu_n)/2.$$

The set $F = \bigcup_{n=1}^{\infty} (\overline{D}_n \cup \Gamma_n) \cup \overline{D}_0 \cup S$ satisfies the conditions of Nersesjan's theorem and is thus a Carleman set.

We can find an entire function $g(z)$ which satisfies $|g(z)| < \delta$ on S as before and such that

$$|h(z) + g(z) + k - \log L_n| < \delta_n \text{ on } \overline{D}_n, \quad n \in \mathbb{N} \cup \{0\}, \quad (3.13)$$

$$|h(z) + g(z) + k - \log L_0| < \delta'_n \text{ on } \Gamma_n,$$

where $L_0(z) = 6$, $L_n(z) = K_{n+1} + \lambda_n(z - K_n)$, $n \geq 1$ and $\delta_n > 0$, $\delta'_n > 0$ are so small that

$$|f(z) - 6| < \frac{1}{2} \text{ in } \overline{D_0} \cup \left(\bigcup_n \Gamma_n\right), \quad (3.14)$$

$$|f(z) - L_n(z)| < \epsilon_n \text{ in } \overline{D_n}, \quad n \geq 1. \quad (3.15)$$

Properties of $f(z)$

(b) It follows from (3.14) that $\overline{D_0}$ belongs to an invariant component G_0 of $F(f)$ in which $f^n(z)$ converges to an attracting fixed point.

(c) For $n \geq 1$, $f(\Delta_n) \subset D(K_{n+1}, \lambda_n + \epsilon_n)$. Also for any z on $C(K_n, \mu_n)$ and $w \in D(K_{n+1}, \lambda_n + \epsilon_n)$ we have, from (3.15) and (3.9), that

$$|f(z) - L_n(z)| < \epsilon_n,$$

$$|L_n(z) - K_{n+1} - w + K_{n+1}| \geq \lambda_n \mu_n - \lambda_n - \epsilon_n > \epsilon_n.$$

Thus it follows from Rouché's theorem that

$$f(z) - w = f(z) - L_n(z) + L_n(z) - w = 0$$

has at most one solution inside $C(K_n, \mu_n)$. This implies that $f(z)$ is univalent in Δ_n . Further $f(\Delta_n)$ covers $D(K_{n+1}, \lambda_n - \epsilon_n) \supset D(K_{n+1}, \lambda_{n+1})$ by (3.10). Indeed for $1 > r_n > \frac{1}{2}$ we have

$$f(D(K_n, r_n)) \subset D(K_{n+1}, \lambda_n r_n + \epsilon_n) \subset D(K_{n+1}, r_n(\lambda_n + 2\epsilon_n))$$

which is a subset of $D(K_{n+1}, r_n \lambda_{n-1})$ by (3.10). Thus we have

$$f^n(D(K_1, r)) \subset D(K_{n+1}, r \prod_{k=1}^n (\lambda_{k-1})),$$

where $\lambda_0 = \lambda_1 + 2\epsilon_1$, so $f^n(D(K_1, r)) \subset D(K_{n+1}, 1.01r)$ by (3.8), so long as $1.01r < 1$.

Thus we certainly have

$$f^n(D(K_1, 0.98)) \subset \Delta_{n+1}, \quad n \in \mathbf{N}. \quad (3.16)$$

(d) It is clear from (3.16) that $D(K_1, 0.98)$ belongs to a component G of $F(f)$ in which $f^n \rightarrow \infty$. We claim that \bar{G} is compact, indeed that $G \subset \Delta_1$. It will follow from this that every $f^n(G)$ is bounded and that G is a wandering component. If G is not contained in Δ_1 , there is a (compact) arc γ which joins $z = K_1$ to $\partial\Delta_1$ in $G \cap \Delta_1$. Thus γ has positive distance d from G^c .

For any $n \in \mathbb{N}$ the circle $C_{n+1} = C(K_{n+1}, \lambda'_{n+1})$ is in $f(\Delta_n)$, where $D(K_{n+1}, \lambda_{n+1}) \subset f(\Delta_n)$, (see (c)). Now f^{-1} maps $f(\Delta_n)$ univalently to Δ_n and so f^{-n} maps $f(\Delta_n)$ univalently onto a subdomain of Δ_1 . Since C_{n+1} is outside Δ_{n+1} , so $f^{-n}(C_{n+1})$ is inside Δ_1 , outside $D(K_1, 0.98)$ and is a curve which encloses this latter disc. Thus $f^{-n}(C_{n+1})$ meets γ and contains an arc σ which joins a point of γ (in G) to a point of ∂G . [Those points of $f^{-n}(C_{n+1})$ which are in $f^{-n}(\Gamma_{n+1})$ are not in G since their forward orbits eventually stay in G_0]. Thus $f^n(\sigma)$ does not meet Γ_{n+1} (except perhaps at an end), so $f^n(\sigma) \subset \sigma'$ where $\sigma' = \{z : |z| = \lambda'_{n+1}, |\arg z| \leq \eta_{n+1}\}$.

In $H = f(\Delta_n)$ the Poincaré metric $\rho(z)|dz|$ (see e.g [53]) satisfies

$$\rho(z) \leq \frac{1}{d(z, \partial H)}.$$

Thus on σ'

$$\rho(z) < \frac{1}{\lambda_{n+1} - \lambda'_{n+1}} = \frac{2}{\lambda_{n+1} - \mu_{n+1}}.$$

The hyperbolic length of σ' in H is thus at most

$$\frac{4\eta_n \lambda'_{n+1}}{\lambda_{n+1} - \mu_{n+1}} < \frac{4\eta_n \lambda_{n+1}}{\lambda_{n+1} - \mu_{n+1}}.$$

But this is the same as the hyperbolic length of σ in $\tilde{H} = f^{-n}(f(\Delta_n))$. But $\tilde{H} \subset \Delta_1$ and hyperbolic length decreases as the domain increases. In Δ_1 we have that $\rho(z) = \frac{1}{1-|z|^2}$ so that hyperbolic length is \geq euclidean length. Thus d is at most equal to the euclidean length of σ , so is less or equal than

$$\frac{4\eta_n \lambda_{n+1}}{(\lambda_{n+1} - \mu_{n+1})}.$$

Since

$$\frac{4\eta_n \lambda_{n+1}}{(\lambda_{n+1} - \mu_{n+1})} \rightarrow 0 \text{ as } n \rightarrow \infty$$

we have a contradiction to $d > 0$. The claim is proved.

(e) Finally, $f(z)$ maps the unit circumference inside $D(K_1, 0.95)$ (as in the previous theorem) and so inside G . Thus the unit circumference belongs to a normal component A of $f(z)$ such that $f(A) = G$. As in the previous theorem $f(\partial B)$ is outside $D(K_1, 1)$ so outside G and thus \overline{A} is compact.

3.8 Proof of Theorem 3.1.7

The method used to prove Theorem 3.1.7 is given in a manuscript [47] of M.R. Herman, who describes it as a generalisation of a construction of E. Ghys. Lemma 23 is our justification of a step in Herman's construction (essentially the existence of H at equation (3.23) which was not immediately obvious to us).

Preliminaries

We denote the unit circumference by S . An orientation preserving homeomorphism of S may be lifted by the map $\tilde{\pi} : x \rightarrow \exp(2\pi ix)$ to an increasing homeomorphism f of \mathbf{R} such that $f(x + 1) = f(x) + 1$. We say that such a homeomorphism f is in $D^0(T)$, (or in $D^\infty(T)$ if it is in addition a C^∞ diffeomorphism).

An increasing homeomorphism $h(z)$ of $\overline{\mathbf{R}}$ with $h(\infty) = \infty$ is called a quasisymmetric if there exists $M \geq 1$ such that for every $x \in \mathbf{R}$ and t in $\mathbf{R}_* = \mathbf{R} \setminus \{0\}$, we have

$$\frac{1}{M} \leq \frac{h(x+t) - h(x)}{h(x) - h(x-t)} \leq M. \quad (3.17)$$

The quasisymmetric norm $|h|_{qs}$ is the inf of values M for which such an inequality (3.17) holds.

We denote by T_α the translation $x \rightarrow x + \alpha$ of \mathbf{R} , which is one of the lifts of the rotation $R_\alpha : t \rightarrow t \exp(2\pi i\alpha)$ of S . For $f \in D^0(T)$ the rotation number of f is $\rho(f) = \lim_{n \rightarrow \infty} f^n(x)/n$.

For a homeomorphism F of S we define $\rho(F)$ to be $\rho(f) \pmod{1}$ for any lift f of F . This is well-defined and invariant under orientation preserving conjugacies.

If $f \in D^0(T)$ and $f_\beta = \beta + f$ for $\beta \in \mathbf{R}$, then $\rho(f_\beta)$ depends continuously on β and increases monotonely by 1 as β increases by 1.

We note Denjoy's theorem:

If F is a C^2 orientation preserving diffeomorphism of S with irrational rotation number $\rho(F)$, then F is topologically conjugate to $R_{\rho(F)}$.

We shall work in terms of lifts.

LEMMA 18. *If $f \in D^\infty(T)$ and $\rho(f) = \alpha \in \mathbf{R} \setminus \mathbf{Q}$, then there is g in $D^0(T)$ such that $gfg^{-1} = T_\alpha$. We note that the only members of $D^0(T)$ which conjugate T_α to itself are the maps T_β , $\beta \in \mathbf{R}$. Thus g is unique up to an additive constant.*

Herman's main result is as follows.

DEFINITION. $f \in D^\infty(T)$ has the property A_0 if there is no f_β for which some iterate lifts the identity map of S .

LEMMA 19 [16]. *If $f \in D^\infty(T)$ is the lift of a map F of S which has an extension to a non-injective meromorphic function on \mathbf{C}_* , then f has the property A_0 .*

THEOREM 3.8.1 [46]. *If $f \in D^\infty(T)$ and f has the property A_0 , then there exists $\beta \in \mathbf{R}$ such that*

- (i) f_β has an irrational rotation number (say α),
- (ii) $f_\beta = gT_\alpha g^{-1}$, $g \in D^{qs}(T)$, $g(0) = 0$,
- (iii) $g(z)$ is not smooth of class C^2 .

We also recall that the following results on quasiconformal maps (see Lehto [53] for definitions and properties).

A topological map of the plane domain D into $\widehat{\mathbf{C}}$ is quasiconformal if it is ACL (absolutely continuous on almost every horizontal or vertical line) and if there is a constant k , $0 \leq k < 1$, such that the derivatives $\phi_z = \frac{1}{2}(\phi_x - i\phi_y)$ and $\phi_{\bar{z}} = \frac{1}{2}(\phi_x + i\phi_y)$ satisfy $|\phi_{\bar{z}}| \leq k|\phi_z|$ almost everywhere.

The quantity $\mu(z) = \phi_{\bar{z}}/\phi_z$, which is defined almost everywhere, is the complex dilatation of ϕ . The map ϕ is conformal if and only if $\mu(z) = 0$ almost everywhere.

LEMMA 20. *Suppose that $f(z)$ is a bijective conformal map from a domain D to a domain D_1 and that ϕ is a quasiconformal map defined on D and D_1 such that*

$$\mu(f(z)) = \frac{\mu(z)f'(z)}{f'(z)} \text{ a.e. in } D. \quad (3.18)$$

Then $\phi f \phi^{-1}$ is conformal in $\phi(D)$. Conversely, if ϕ is quasiconformal, $f(z)$ is analytic and $\phi f \phi^{-1}$ is analytic, then (3.18) holds.

LEMMA 21 (The measurable Riemann mapping theorem). *Given any measurable function μ on \mathbf{C} such that $\|\mu\|_\infty < 1$, there exists a unique sense-preserving quasiconformal homeomorphism ϕ of $\widehat{\mathbf{C}}$ to $\widehat{\mathbf{C}}$, such that $\phi_{\bar{z}} = \mu\phi_z$ almost everywhere and ϕ fixes $0, 1, \infty$.*

LEMMA 22 (The Beurling-Ahlfors extension theorem (e.g. [53], p.33)). *Let $h : \mathbf{R} \rightarrow \mathbf{R}$ be quasisymmetric. Then*

$$\begin{aligned} k(x + iy) &= \frac{1}{2} \int_0^1 \{h(x + ty) + h(x - ty)\} dt \\ &\quad + i \int_0^1 \{h(x + ty) - h(x - ty)\} dt, \quad x \in \mathbf{R}, y > 0, \end{aligned} \quad (3.19)$$

defines a continuously differentiable quasiconformal self-mapping of the upper half-plane, whose boundary values are h .

LEMMA 23. *Let $h \in D^0(T)$ be quasisymmetric. Then there is a quasiconformal extension \tilde{h} of h which maps the strip $L = \{z : 0 \leq \text{Im}z \leq 2\}$ onto itself. For all $x \in \mathbf{R}$ we have $\tilde{h}(x + 2i) = h(x) + 2i$. Thus if we write $\tilde{\pi}(z) = \exp(2\pi iz)$ for z in L , then $H = \tilde{\pi}\tilde{h}\tilde{\pi}^{-1}$ maps the annulus $\{w : \rho \leq |w| \leq 1\}$, $\rho = \exp(-4\pi)$, onto itself by a quasiconformal homeomorphism such that $H(\rho e^{i\theta}) = \rho H(e^{i\theta})$.*

Proof. The extension $k(x + iy)$ of Lemma 22 has the property $k(z + 1) = k(z) + 1$. Further, the imaginary part of $k(x + i)$ is

$$\int_{x-1}^x (h(t+1) - h(t)) dt = 1.$$

Since $h(x) = x + \theta(x)$, where $\theta(x)$ is a function of period one, the real part of $k(x + i)$ is

$$\frac{1}{2} \int_{x-1}^x (t + \theta(t)) dt + \frac{1}{2} \int_x^{x+1} (t + \theta(t)) dt = x + \alpha,$$

where α is the integral of θ over a period.

Thus k is a quasiconformal homeomorphism of $L' = \{z : 0 \leq \text{Im}z \leq 1\}$ to itself which maps $x + i$ to $(x + \alpha) + i$. If we define

$$\tilde{h}(z) \begin{cases} k(z) & \text{in } L' \\ ShSz & \text{in } L - L', \end{cases}$$

where S denotes reflection in the line $y = 1$, we obtain a quasiconformal homeomorphism of L to itself such that $\tilde{h}(x + 2i) = \tilde{h}(x) + 2i$.

Since $\tilde{h}(z+1) = \tilde{h}(z) + 1$, the map H is well-defined and has the properties claimed.

Proof of Theorem 3.1.7

We take $G(z) = e^{2\pi i\beta} z \exp a(z-z^{-1})$, where a is a real constant such that $0 < 2a < 1$, and β is a real constant. Thus $G(z)$ is an analytic homeomorphism of S whose lift to \mathbf{R} by $\tilde{\pi}$ is $g(x) = x + \beta + \frac{a}{\pi} \sin 2\pi x$. This satisfies condition A_0 of Lemma 19. We choose β to satisfy Herman's Theorem 3.8.1 Thus g has an irrational rotation number α and there is a $\phi \in D^{qs}(T)$ but not in C^2 such that $g = \phi T_\alpha \phi^{-1}$.

The idea of the proof is to replace G by a new function M which is quasiconformally conjugate to a rotation R_α in a ring $B = \{z : t \leq |z| \leq t^{-1}\}$, is a continuous map of \mathbf{C}_* to itself, and is only a slight modification of G outside B . This is done in (i). In (ii) we construct a quasiconformal homeomorphism ψ of \mathbf{C}_* such that $N = \psi M \psi^{-1}$ is analytic. In (iii) we prove that $\psi(B)$ is a Herman ring for N , whose boundary contains neither 0 nor ∞ .

(i) Let $t = \exp(-2\pi)$, so that $t^2 = \rho$ in Lemma 23. We put

$$G_1(z) = \begin{cases} \frac{1}{t}G(tz), & |z| \geq \frac{1}{t} \\ tG(z/t) = t/\overline{G}(t/\overline{z}) = 1/\overline{G_1}(1/z), & |z| \leq t. \end{cases} \quad (3.20)$$

Thus on the circle

$$C_{\frac{1}{t}} : G_1(t^{-1}e^{i\theta}) = t^{-1}G(e^{i\theta})$$

and on

$$C_t : G_1(te^{i\theta}) = tG(e^{i\theta}). \quad (3.21)$$

Since

$$G = \tilde{\pi}g\tilde{\pi}^{-1} = \tilde{\pi}\phi\tilde{\pi}^{-1}\tilde{\pi}T_\alpha\tilde{\pi}^{-1}(\tilde{\pi}\phi\tilde{\pi}^{-1})^{-1}$$

we have for $H = \tilde{\pi}\phi\tilde{\pi}^{-1} : S \rightarrow S$ that $HR_\alpha H^{-1} = G$ on S . Thus it follows from (3.20) and (3.21) that if $Tz = tz$, then

$$\begin{aligned} \text{on } C_{\frac{1}{t}} : G_1 &= (T^{-1}H)R_\alpha(T^{-1}H)^{-1} \\ \text{on } C_t : G_1 &= (TH)R_\alpha(TH)^{-1}. \end{aligned} \quad (3.22)$$

Denote by B the annulus $\{z : t \leq |z| \leq \frac{1}{t}\}$. Applying Lemma 23 to the quasimetric function $h = \phi$ there is an extension of \tilde{h} with a projection by $\tilde{\pi}$ which we may, without confusion, denote by H ; which maps (tB) to itself quasiconformally, with

$$H(t^2 e^{i\theta}) = t^2 H(e^{i\theta}). \quad (3.23)$$

Thus $K = T^{-1}HT$ maps B to B quasiconformally. It follows from (3.22) that

$$\begin{aligned} \text{on } C_{\frac{1}{t}} : \quad G_1 &= KR_\alpha K^{-1}, \\ \text{on } C_t : \quad G_1 &= KR_\alpha K^{-1}. \end{aligned}$$

It follows from (3.23) that on C_t : $T^{-1}HT = THT^{-1}$ and thus

$$G_1 = THT^{-1}TR_\alpha H^{-1}T^{-1} = THT^{-1}R_\alpha(THT^{-1})^{-1}.$$

We now define a function

$$M(z) = \begin{cases} G_1 & \text{outside } B \\ KR_\alpha K^{-1} & \text{in } \bar{B} \end{cases}$$

which is a continuous map of \mathbf{C}_* to itself.

(ii) Let J denote the inverse map of K . The complex dilatation $\mu_J(z) = J_{\bar{z}}/J_z$ is defined almost everywhere in B , with

$$\sup_B |\mu_J| = \mu < 1.$$

We extend μ_J to define a function $\mu(z)$ on \mathbf{C}_* by:

$$\mu(z) = \begin{cases} \mu_J(z) & \text{if } z \in B, \\ \mu_J(M^n(z)) \overline{M^{n'}(z)}/M^{n'}(z) & \text{if } z \text{ is outside } B \text{ and } n \text{ is} \\ \text{the smallest integer such that } M^n(z) \in B, \\ 0 & \text{if there is not such } n. \end{cases} \quad (3.24)$$

Then $\mu(z)$ is measurable and $\sup_{\mathbf{C}_*} |\mu_J| = \mu < 1$. By the measurable Riemann mapping theorem (Lemma 21) there is a quasiconformal homeomorphism ψ of the sphere which fixes 0 and ∞ and has dilatation $\mu(z)$ almost everywhere.

We define $N = \psi M \psi^{-1}$ and show that N is an analytic self-map of \mathbf{C}_* . It is certainly continuous. First note that ψ and $J = K^{-1}$ have the same dilatation in B and are

homeomorphisms. Thus ψK is analytic in $K^{-1}(B) = B$. Hence $N = (\psi K)R_\alpha(\psi K)^{-1}$ holds in $\psi(B)$ and N is an analytic homeomorphism of $\psi(B)$ to itself which is conjugate to R_α .

Outside B we have $\mu(M(z)) = \mu(z)M'(z)/\overline{M'(z)}$ by (3.24), which implies that N is analytic in $\mathbf{C}_* \setminus \overline{\psi(B)}$ except at points where M fails to be one-to-one, thus at isolated points. But these points are removable singularities by the continuity of N . We note also that $\phi(\partial B)$ has plane measure zero. Thus $N_{\bar{z}}/N_z = 0$ a.e. in \mathbf{C} and N is in fact analytic in \mathbf{C}_* .

Since $M(z) = 1$ has solutions clustering at both 0 and ∞ the same is true for solutions of $N(z) = \psi(1)$. Thus both 0 and ∞ are transcendental singularities of $N(z)$.

(iii) Let D be the component of $F(N)$ which contains $\psi(B)$. Clearly D is a Herman ring. We show that $D = \psi(B)$ which will complete the proof.

If this is not true we suppose that D contains some point of $\psi(\partial B)$, without loss of generality some points of $\psi(C_{\frac{1}{t}}) = C'$. Considering the orbits of N in D we see that D contains some doubly-connected domain Δ between C' and some curve γ . Then $\Delta_0 = \psi^{-1}(\Delta)$ is a doubly-connected domain outside $C_{\frac{1}{t}}$ and inside $\psi^{-1}(\gamma)$, which is invariant under G_1 . By reflection of Δ_0 in the curve $C_{\frac{1}{t}}$ which is invariant under G_1 we obtain an invariant domain $\widetilde{\Delta}_0$ such that $E_0 = \widetilde{\Delta}_0 \cup C_{\frac{1}{t}} \cup \Delta_0$ is part of a Herman ring for G_1 . There is thus an analytic conjugation λ of E_0 to a ring $E: a < |z| < b$ such that $\lambda G_1 \lambda^{-1} = R_\alpha$. The circle $C_{\frac{1}{t}}$ is an orbit in E_0 and λ may be normalised so that it maps $C_{\frac{1}{t}}$ to the unit circle S . It follows from (3.20) that $G = T\lambda^{-1}R_\alpha\lambda T^{-1}$ on S and also $G = HR_\alpha H^{-1}$, where $H = \tilde{\pi}\phi\tilde{\pi}^{-1}$. But this contradicts the uniqueness result of Lemma 18 since $T\lambda^{-1}$ is analytic and H is not.

3.9 Final remarks

We may ask for examples of doubly-connected components of $F(f)$ which extend to 0 and/or ∞ . For periodic A this is possible, as is shown by Example 1. This is also possible for wandering A . We sketch a modification of the example constructed in Theorem 3.1.7 to prove our claim.

Let $h, k, B, S, D_0 = D(6, 1), K_n$, and Δ be as in the proofs of Theorems 3.1.5 and 3.1.6 and, further, for $n \geq 1$, $\Delta'_n = D(K_n, 1.9)$, $M_n = \{z : \operatorname{Re} z = K_n\}$, and $L_n = \{z :$

$\text{Re}z = (K_n + K_{n+1})/2\}$.

Note that $\bigcup_{n=1}^{\infty} (\Delta'_n \cup L_n \cup M_n) \cup \overline{D_0} \cup S$ satisfies the conditions of Nersesjan's theorem (Lemma 17). This allows us to find an entire function $g(z)$ such that $f(z)$, defined by $f(z) = \exp(h(z) + g(z) + k)$, is a self-map of \mathbf{C}_* which maps

- (i) The unit circumference to a subset of $D(K_1, 1) \subset \Delta'_1$,
- (ii) $f(\partial B)$ is inside $D(K_1, 1.9)$ and outside $D(K_1, 1.3)$ as in Theorem 3.1.5,
- (iii) $(\bigcup_{n=1}^{\infty} L_n) \cup \overline{D_0}$ to a subset of $D(6, \frac{1}{2}) \subset D_0$, and
- (iv) $M_n \cup \overline{\Delta_n}$, $n \geq 1$, to a subset of $D(K_{n+1}, \frac{1}{2}) \subset \Delta_{n+1}$.

Thus D_0 is part of an invariant component G_0 of $F(f)$ in which f^n converges to an attracting fixed point α . The lines L_n are also in components of $F(f)$ where $f^n \rightarrow \alpha$. On the other hand $M_n \cup \Delta'_n$, $n \geq 1$, belongs to a component G_n in which $f^n \rightarrow \infty$ and this is a wandering component, since G_n is separated from G_{n+1} by L_n .

The annulus B belongs to a doubly-connected component A of $F(f)$ such that $F(A) \subset G_1$. Let γ_1 be the outer boundary of B . There is a point z_1 on γ_1 such that $f(z_1) \in M_1$, $\text{Im}f(z_1) > 0$. Let $z = \phi(w)$ denote the branch of f^{-1} such that $\phi(f(z_1)) = z_1$. If we can continue $\phi(w)$ along M_1 to ∞ (with $\text{Im}w$ increasing) in which can $\phi(w) \rightarrow 0$ or ∞ through values which remain in $F(f)$. These values of $\phi(w)$ cannot meet the unit circumference, by (i) and (ii). Hence $\phi(w) \rightarrow +\infty$. If this is not possible it can only be because we meet a transcendental singularity of ϕ^{-1} on M_1 and then $\phi(w) \rightarrow \infty$ as before. Thus in either case A extends to ∞ . A similar discussion, starting in the inner boundary of B , shows that A extends to 0 also. Thus we have a wandering annulus which extends 0 and ∞ , as claimed.

We do not have any example where it is definitely known that a Herman ring extends to 0 and ∞ .

C H A P T E R 4

Dynamics of transcendental meromorphic functions

4.1 Introduction to Chapter 4

The chapter examines some properties of the dynamics of entire functions which extend to general meromorphic functions and also some properties which do not. For a transcendental meromorphic function $f(z)$ whose Fatou set $F(f)$ has a component of connectivity at least three, it is shown that singleton components are dense in the Julia set $J(f)$. Some problems remain open if all components are simply or doubly connected.

Let $I(f)$ denote the set of points whose forward orbits tend to ∞ but never land at ∞ . We shall prove that for a transcendental meromorphic function $f(z)$ we have $J(f) = \partial I(f)$, $I(f) \cap J(f) \neq \emptyset$. However in contrast to the entire case, the components of $\overline{I(f)}$ need not be unbounded, even if $f(z)$ has only one pole.

If $f(z)$ has finitely many poles then, as in the entire case, $F(f)$ has at most one completely invariant component.

Let $f(z) : \mathbb{C} \rightarrow \widehat{\mathbb{C}}$ denote a meromorphic function, $f^n, n \in \mathbb{N}$, the n -th iterate of $f(z)$, and f^{-n} the set of inverse functions of f^n .

Let A be the set of poles of $f(z)$, $B = \cup_{n=1}^{\infty} f^{-n}(A)$ the set of preimages of ∞ , and B' the derived set of B .

The Fatou set $F(f)$ is defined to be the set of those points $z \in \widehat{\mathbb{C}}$ such that the sequence $(f^n)_{n \in \mathbb{N}}$ is well defined, is meromorphic, and forms a normal family in some neighbourhood of z . The complement $J(f)$ of $F(f)$ is called the Julia set of $f(z)$.

We define $E(f)$ to be the set of exceptional values of $f(z)$, that is, the points whose inverse orbit $O^-(z) = \{w : f^n(w) = z \text{ for some } n \in \mathbb{N}\}$ is finite. There can be at most two such points and if $\infty \in E(f)$ then either $f(z)$ is entire or has a single pole α which is a Picard value of $f(z)$, so that

$$f(z) = \alpha + (z - \alpha)^{-k} e^{g(z)}, \quad (4.1)$$

for some $k \in \mathbb{N}$ and some entire function $g(z)$. The meromorphic functions thus fall into

four disjoint classes.

- (i) The rational functions (where we assume the degree to be at least two).
- (ii) The class **E** of transcendental entire functions.
- (iii) The class **P** of transcendental functions of the type (4.1), self maps of the punctured plane which have a meromorphic extension to \mathbf{C} .
- (iv) **M**, the class called general meromorphic functions in [16], of transcendental meromorphic functions, for which $\infty \notin E(f)$.

The iteration of the classes (i) and (ii) is sufficiently well-known. The class **P** has been studied in [12, 22, 25, 36, 37, 38, 48, 49, 51, 52, 55, 56, 58, 67] and **M** in [14, 15, 16]. See [21] for a survey of the main results. For the first three classes the iterates are automatically defined in the plane or punctured plane and the study of the normality of $\{f^n\}$ is the main feature. For $f(z) \in \mathbf{M}$ the set B , defined above, is infinite and it is shown in [14] that $J(f) = \overline{B} = B'$.

Many properties of $J(f)$ and $F(f)$ are much the same for **M** as for the other classes but different proofs are needed and some discrepancies arise. We recall (see e.g. [21]) that for $f(z)$ in any of the four classes:

1. $F(f)$ is open and completely invariant under $f(z)$, that is, $z \in F(f)$ if and only if $f(z) \in F(f)$.
2. For $z_0 \notin E(f)$, $J(f) \subset \overline{O^-(z_0)}$.
3. Repelling periodic points are dense in $J(f)$.
4. If U is a periodic component of $F(f)$ of period p , that is if $f^p(U) \subset U$, there are the following possible cases
 - U contains an attracting periodic point z_0 of period p . Then $f^{np}(z) \rightarrow z_0$ for $z \in U$ as $n \rightarrow \infty$, and U is called the immediate attractive basin of z_0 .
 - ∂U contains a periodic point z_0 of period p and $f^{np}(z) \rightarrow z_0$ for $z \in U$ as $n \rightarrow \infty$. Then $(f^p)'(z_0) = 1$ if $z_0 \in \mathbf{C}$. (For $z_0 = \infty$ we have $(g^p)'(0) = 1$ where $g(z) = 1/f(1/z)$). In this case, U is called a Leau domain.

- There exists an analytic homeomorphism $\psi: U \rightarrow D$ where D is the unit disc such that $\psi(f^p(\psi^{-1}(z))) = e^{2\pi i\alpha}z$ for some $\alpha \in \mathbf{R} \setminus \mathbf{Q}$. In this case, U is called a Siegel disc.
- There exists an analytic homeomorphism $\psi: U \rightarrow A$ where A is an annulus $A = \{z : 1 < |z| < r\}, r > 1$, such that $\psi(f^p(\psi^{-1}(z))) = e^{2\pi i\alpha}z$ for some $\alpha \in \mathbf{R} \setminus \mathbf{Q}$. In this case, U is called a Herman ring.
- There exists $z_0 \in \partial U$ such that $f^{np}(z) \rightarrow z_0$, for $z \in U$ as $n \rightarrow \infty$, but $f^p(z_0)$ is not defined. In this case, U is called a Baker domain.

5. If $p = 1$ in 4, that is if U is an invariant component of $F(f)$, then U has connectivity 1, 2, or ∞ . If the connectivity is two, then U is a Herman ring.

The purpose of this chapter is to examine whether some properties of the sets $J(f)$ or $F(f)$, which hold for transcendental entire functions, extend to transcendental meromorphic functions or perhaps at least to transcendental meromorphic functions with finitely many poles.

It is known that the Fatou set $F(g)$ of a transcendental entire function $g(z)$ may have a multiply-connected component U [4], that any such component is bounded [8], and that $g^n \rightarrow \infty$ in U so that each $g^n(U)$ belongs to a different component of $F(g)$. It is a corollary that $J(g)$ is not totally disconnected but Chapter 2, Section 2.8, shows that if U is multiply-connected, then singleton components are everywhere dense in $J(g)$.

The existence of singleton components of $J(f)$ for transcendental meromorphic functions follows from the following general result.

THEOREM A. *Suppose that $f(z)$ is a transcendental meromorphic function and that $F(f)$ has a component H of connectivity at least three. Then singleton components are dense in $J(f)$.*

We note that in [15] there are examples of functions in \mathbf{M} with Fatou components of any prescribed connectivity.

If R is a doubly-connected component of $F(f)$, then its complement consists of two components, one bounded and the other unbounded. The methods used to prove Theorem A also give Theorem B.

THEOREM B. *Suppose that $f(z)$ is a transcendental meromorphic function and that $F(f)$*

has three doubly-connected components U_i such that either,

- (a) each component lies in the unbounded component of the complement of the other two
or
- (b) two of the components U_1, U_2 lie in the bounded component of U_3^c but U_1 lies in the unbounded component of U_2^c and U_2 lies in the unbounded component of U_1^c .

Then singleton components are dense in $J(f)$.

The preceding results show that if for the transcendental meromorphic function $f(z)$ the Julia set has no singleton components, then any multiply-connected component of $F(f)$ has connectivity two and moreover, the distribution of these doubly-connected components is subject to severe restrictions. On the other hand we have not been able to show that such components cannot occur. For functions $f(z)$ of class \mathbf{P} it is known [12] that $F(f)$ can have at most one multiply-connected component and the connectivity of such component is 2. Thus $J(f)$ has no singleton components.

W. Bergweiler in [21, p.164] mentions the problem of whether a meromorphic function $f(z)$ in the special class \mathbf{P} can have a Herman ring. This would necessarily be invariant. The question is answered by the following theorem.

THEOREM C. *If $f(z) \in \mathbf{P}$, then $f(z)$ has no Herman ring.*

If we drop the requirement that $f(z)$ is transcendental the rational function $R(z) = z^2 + \lambda/z^3$, $\lambda > 0$, has infinitely many doubly-connected Fatou components, while $J(R)$ is a Cantor set of circles and in particular has no singleton components, see [20, p.266] for the details.

THEOREM D. *Let $f(z)$ be a transcendental meromorphic function and suppose that $F(f)$ has multiply-connected components A_i , $i \in \mathbf{N}$, all different, such that each A_i separates 0, and ∞ and $f(A_i) \subset A_{i+1}$ for $i \in \mathbf{N}$. Then $J(f)$ has a dense set of singleton components.*

There are examples of $f(z) \in \mathbf{E}$ which satisfy the assumptions of Theorem D and in this case $A_i \rightarrow \infty$ [9, 10]. It is not easy to determine the connectivity of A_i although examples are known [11] where this is infinite. It seems to be an open problem as to

whether the connectivity of A_i can be 2 for $f(z) \in \mathbf{E}$. Similar constructions would give examples of functions in \mathbf{M} with a finite number of poles and A_i which tend to ∞ . More interesting examples can be given by other methods as shown by Theorem E.

THEOREM E. *There is a transcendental meromorphic function such that $F(f)$ has a sequence of multiply-connected components A_i , $i \in \mathbf{N}$, all different, such that each A_i separates 0 and ∞ and $f(A_i) \subset A_{i+1}$, $i \in \mathbf{N}$. Moreover $A_{2i} \rightarrow \infty$ as $i \rightarrow \infty$ and $A_{2i+1} \rightarrow 0$ as $i \rightarrow \infty$.*

It will follow from the later Theorem G that any function which satisfies the assumption of Theorem E has infinitely many poles.

Functions with finitely many poles

We shall examine whether a number of results about the dynamics of transcendental entire functions extend to meromorphic functions with finitely many poles. A useful tool here is a theorem of H. Bohr (Theorem 4.5.1) which was used already in dynamics by Pólya [64] to estimate the growth of composed functions such as iterates. We make a slight extension of the result in Theorem 4.5.2. From it we shall deduce the following

THEOREM F. *If $f(z)$ is a transcendental meromorphic function with finitely many poles, then there is some $S > 0$ such that no invariant component G of $F(f)$ can contain a curve γ which lies in $\{z : |z| > S\}$ and satisfies $n(\gamma, 0) \neq 0$.*

COROLLARY. *If f is a transcendental meromorphic function with finitely many poles, then $J(f)$ cannot be totally disconnected.*

The result is known for $f(z) \in \mathbf{E}$ [8] but is untrue for meromorphic functions without restriction to finitely many poles. For example, the function $f(z) = \lambda \tan z$, $0 < \lambda < 1$, has a Julia set which is a Cantor subset of the real line, see [15] and [31].

For $f(z) \in \mathbf{E}$ any unbounded invariant component is simply connected. This is no longer true for functions with even one pole. We show in Section 4.9 that for $\epsilon = 10^{-2}$, $f(z) = z + 2 + e^{-z} + \epsilon(z - (1 + i\pi))^{-1}$ has a multiply-connected invariant component in which $f^n(z) \rightarrow \infty$.

Orbits which tend to ∞

For $f(z) \in \mathbf{E}$ Eremenko [33] studied the set

$$I(f) = \{z \in \mathbf{C} : f^n(z) \rightarrow \infty \text{ as } n \rightarrow \infty\}.$$

He proved that for $f(z) \in \mathbf{E}$ we have (a) $I(f) \neq \emptyset$, (b) $J(f) = \partial I(f)$, (c) $I(f) \cap J(f) \neq \emptyset$, and (d) The closure $\overline{I(f)}$ of $I(f)$ has no bounded components. It remains open as to whether $I(f)$ itself may have bounded components. Fatou [40] had already noted that in the examples studied by him, $I(f)$ contains unbounded analytic curves and asked whether this was a general phenomenon.

For meromorphic functions $f(z)$ we generalise Eremenko's definition by writing

$$I(f) = \{z \in \mathbf{C} : f^n(z) \rightarrow \infty \text{ as } n \rightarrow \infty \text{ and } f^n(z) \neq \infty\}.$$

We show in Section 4.6 that for transcendental meromorphic functions $I(f)$ has the properties (a), (b), and (c) listed above but (d) does not hold in general, even for functions with finitely many poles. These results form the following five theorems.

THEOREM G. *For a transcendental meromorphic function $f(z)$ with only finitely many poles the set $I(f)$ is not empty. Indeed for any curve γ with $n(\gamma, 0) \neq 0$ and such that $d(0, \gamma)$ is sufficiently large we have $I(f) \cap \gamma \neq \emptyset$.*

THEOREM H. *For a transcendental meromorphic function $f(z)$ with infinitely many poles the set $I(f)$ is not-empty. Indeed in any neighbourhood of a pole there are points of $I(f)$.*

THEOREM I. *If $f(z)$ is a transcendental meromorphic function, then $J(f) = \partial I(f)$.*

THEOREM J. *If $f(z)$ is a transcendental meromorphic function, then $I(f) \cap J(f) \neq \emptyset$.*

Theorems G and J follow from the same argument as Theorem F, based on our extension of Bohr's theorem. This gives an alternative to Eremenko's proof in the special case of entire functions. His proof was based on Wiman-Valiron theory.

The assertion of Theorem G is not in general true for meromorphic functions with infinitely many poles. For example, if $f(z) = \lambda \tan z$, $0 < \lambda < 1$, then $\overline{I(f)} \subset J(f)$, and $J(f)$ is a real Cantor set which fails to meet $\gamma = C(0, r)$ for many arbitrarily large

values of r . However, we shall have $I(f) \neq \emptyset$. Further (d) fails for this choice of $f(z)$, since every component of $\overline{I(f)}$ is bounded. The example $f(z) = \lambda \sin z - \frac{\epsilon}{z-\pi}$, $\epsilon > 0$, $0 < \lambda < 1$, considered in Section 4.9 shows that if $g(z)$ has even one pole, then $\overline{I(g)}$ may have bounded components.

Completely invariant components

For transcendental functions it has been known since the early work of Fatou and Julia that $F(f)$ can have at most two completely invariant components. In [7] it was shown that if $f(z) \in \mathbf{E}$, then there is at most one completely invariant component of $F(f)$. In Section 4.7 we show that this last result extends to transcendental meromorphic functions with finitely many poles.

THEOREM K. *Let $f(z)$ be a meromorphic function with at most finitely many poles. Then there is at most one completely invariant Fatou domain.*

The theorem fails for functions with infinitely many poles. For example if $f(z) = \lambda \tan z$, $\lambda > 1$, then $F(f)$ has two completely invariant components namely the upper and lower half-plane (each of which contains an attracting fixed point). It is an open problem for general transcendental meromorphic functions as to whether the Fatou set can have more than two completely invariant components. However for a transcendental function whose inverse is singular at only finitely many points the maximum number of completely invariant Fatou components is two [16].

Functions with one pole

The final section contains two examples. Recall that for $f(z) \in \mathbf{E}$ any multiply-connected component G of $F(f)$ is bounded with $f^n \rightarrow \infty$ in G . This is no longer true for meromorphic functions with even one pole.

We show in Example 1, Section 4.9, that for $\epsilon = 10^{-2}$ and $a = 1 + i\pi$ the function $f(z) = z + 2 + e^{-z} + \epsilon(z - a)^{-1}$ has a multiply-connected invariant component in which $f^n(z) \rightarrow \infty$.

In a similar way we show that for $0 < \lambda < 1$ and for sufficiently small positive ϵ the function $f(z) = \lambda \sin z - \frac{\epsilon}{z-\pi}$ has a single completely invariant Fatou component. This is unbounded, multiply-connected and the iterates f^n converge to a finite limit (an

attracting fixed point) in $F(f)$. Singleton components of $J(f)$ are dense in $J(f)$, which also contains unbounded continua.

We precede the examples by stating some results about the relation between the orbits of singular points of f^{-1} and the possible limit functions of iterates. These are used in discussing of Example 2, Section 4.9.

4.2 Proof of Theorem A

In this section our aim is to prove Theorem A. We shall start this section by giving the following lemma.

LEMMA 24. *If D is a domain in $\widehat{\mathbf{C}}$ whose complement contains at least p components H_1, \dots, H_p , then there are p disjoint simple polygons γ_i , $0 \leq i \leq p$, in D such that γ_i separates H_i from the remaining H_j , $j \neq i$. Thus there is a component D_i of the complement of γ_i such that $H_i \subset D_i$ and $\overline{D_i} \cap \overline{D_j} = \emptyset$ for $j \neq i$.*

A proof may be obtained from results in [60]. Firstly there is a partition of the complement of D into p disjoint closed sets F_i , such that $H_i \subset F_i$, $1 \leq i \leq p$. The method of Theorem 3.1 and Theorem 3.2 in Chapter VI of [60] gives a construction of a simple polygon γ_i , uniformly as close as we wish to a subset of F_i which satisfies the requirements of the lemma.

In order to prove Theorem A we require a result from Ahlfors' theory of covering surfaces. If a function $g(z)$ is meromorphic in \mathbf{C} and D is a simply-connected domain in $\widehat{\mathbf{C}}$, whose boundary is a sectionally analytic Jordan curve γ , then an *island* (with respect to $g(z)$) over D is a bounded component G of $g^{-1}(D)$ so that $g(G) = D$ and the map $g : G \rightarrow D$ is a finite branched cover. Thus we have $g(\partial G) = \gamma$.

The following result is given as a corollary of Theorem VI.8 in [71]. It also follows from [43, Theorem 5.5].

LEMMA 25. *If $g(z)$ is a transcendental and meromorphic function in \mathbf{C} , then given any three simply-connected domains D_i , $1 \leq i \leq 3$, with sectionally analytic boundaries, such that $\overline{D_i}$ are mutually disjoint, there is at least one value of i such that $g(z)$ has infinitely many simply-connected islands over D_i .*

Proof of Theorem A

Since the theorem is known for $f(z) \in \mathbf{E}$ and since for $f(z) \in \mathbf{P}$ there are no components of $F(f)$ whose connectivity is greater than or equal to three, we can suppose that $f(z) \in \mathbf{M}$ and that $F(f)$ has a component D whose connectivity is at least three. Thus D^c has at least three components H_1, H_2, H_3 . It follows from Lemma 24 that there are simple polygons γ_i in D , $1 \leq i \leq 3$, and (simply-connected) complementary domains D_i of γ_i such that $\overline{D_i} \cap \overline{D_j} = \emptyset$, $j \neq i$, and each D_i contains points of the Julia set.

Now pick any point ξ_1 in the Julia set and any open neighbourhood V_1 which contains ξ_1 . Then there is some $k \in \mathbf{N}$ such that f^k has a pole β in V_1 .

There is a neighbourhood U of β , $\overline{U} \subset V_1$ which is mapped by f^k locally univalently (except perhaps at β) onto a neighbourhood N of ∞ .

It follows from Lemma 25 that $f(z)$ has a simply-connected island $G \subset N \cap \mathbf{C}$, which lies over one of the D_i , say D_1 . The branches of $(f^k)^{-1}$ which take values in U for $z \in G$ are each univalent in G . We take one such branch, say h , which maps G univalently onto the simply-connected domain $V_2 \subset U \setminus \{\beta\}$. Then f^{k+1} maps V_2 onto D_1 and since D_1 meets $J(f)$ it follows that V_2 contains a point ξ_2 of $J(f)$. From $f^{k+1}(\partial V_2) = \gamma_1$ it follows that $\partial V_2 \subset F(f)$.

We may now replace V_1 by V_2 , ξ_1 by ξ_2 and deduce that V_2 contains an arbitrarily small simply-connected neighbourhood V_3 such that $\overline{V_3} \subset V_2$, $\partial V_3 \subset F(f)$, and $\xi_3 \in V_3 \cap J(f) \neq \emptyset$. By continuing inductively we obtain a sequence of nested simply-connected domains V_n , each of which contains a point $\xi_n \in J(f)$. The sets $\overline{V_n}$ may be assumed to shrink to a single point ξ . Then $\xi = \lim \xi_n \in J(f)$. Further ∂V_n is constructed to be in $F(f)$, and so ξ is a singleton component of $J(f)$.

As an application of the preceding theorem we note that for any meromorphic function $f(z)$ with a completely invariant multiply-connected component G of $F(f)$, the connectivity of G is infinite, by item 5 of the introduction, and hence $J(f)$ has dense singleton components.

Further examples are given by the meromorphic functions constructed in [15] which have wandering Fatou components of arbitrary finite connectivity.

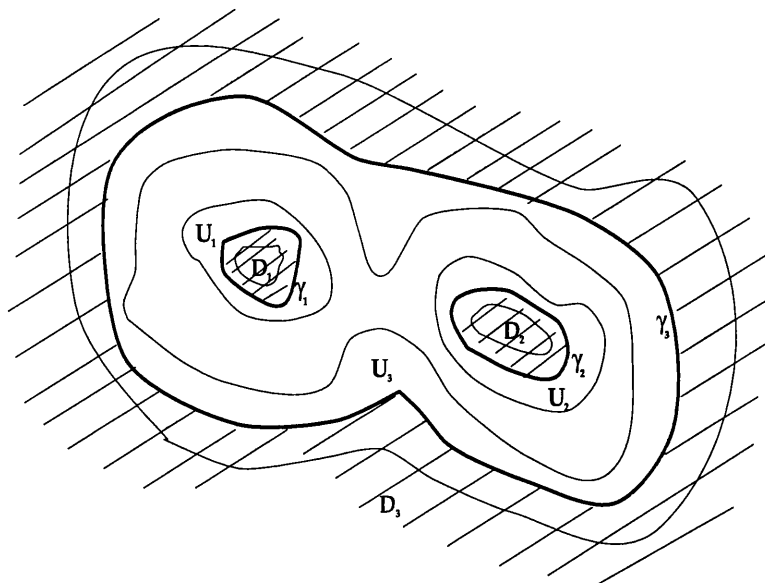

Fig. 4.1: The interiors D_i , $1 \leq i \leq 2$, and the exterior D_3

4.3 Proofs of Theorems B and C

Proof of Theorem B

We may suppose that $f(z) \in \mathbf{M}$ since $f(z) \in \mathbf{P}$ can have at most one doubly-connected Fatou component.

Let γ_i , $1 \leq i \leq 3$, be sectionally analytic curves such that $\gamma_i \subset U_i \subset F(f)$ and γ_i cannot be deformed to a point in U_i .

In case (a) we take D_i to be the interior of γ_i , $1 \leq i \leq 3$, that is, the bounded component of γ_i^c . Now $\gamma_1 \subset F(f)$ is separated by the boundary of the unbounded component of U_1^c from γ_2 and γ_3 . Hence $\overline{D_1}, \overline{D_2}, \overline{D_3}$ are disjoint and each D_i contains points of $J(f)$. The proof now proceeds precisely as for Theorem A but using this interpretation of D_i .

In case (b) we take D_1 and D_2 as in case (a) but take D_3 to be the exterior of γ_3 . See Figure 4.1.

Proof of Theorem C

Suppose that $f(z)$ is a function in \mathbf{P} with an invariant Herman ring R . Thus $f(z)$ has the form (4.1) for some α and k .

Let γ be the closure of an orbit in R , where we choose γ to avoid the countable set of

algebraic singularities of f^{-1} . Then γ is an analytic Jordan curve. Denote the interior of γ by I . We show that I contains the pole α of $f(z)$.

Suppose $f(z)$ is analytic in I . Then $f(I)$ is bounded and $\partial(f(I)) \subset f(\partial I) = f(\gamma) = \gamma$. It follows that $f(I) = I$ which implies that $f^n(I) = I$ and $I \subset F(f)$, but I contains points of ∂R by assumption. This contradiction shows that I contains the pole α .

Now I contains an orbit γ' of $f(z)$ in R which is different from γ . Hence $f(I)$ meets I and so $I \subset f(I)$. Hence there is some point $\beta \in I$ such that $f(\beta) = \alpha \in I$. This contradicts the assumed form of $f(z)$ and the theorem is proved.

4.4 Proofs of Theorems D and E

Proof of Theorem D

The assertion of the Theorem D follows from Theorem A unless all A_i have connectivity two. The result is already known for $f(z) \in \mathbf{E}$. Further, it is known [12] that if $f(z) \in \mathbf{P}$ the set $F(f)$ has at most one multiply-connected component. Thus we may assume that $f(z) \in \mathbf{M}$ and that A_i are all bounded doubly-connected domains which separate 0 from ∞ .

Now A_1 is a wandering component of $F(f)$ so that the limit functions of convergent sequences f^{n_j} in A_1 are necessarily constant [16]. We note that each A_i is bounded and thus the map $f : A_i \rightarrow A_{i+1}$ is a (possibly branched) covering. In fact it follows from the Riemann-Hurwitz relation that $f(z)$ is an unbranched k_i to 1 covering map for some $k_i \in \mathbf{N}$. Thus if the path $\gamma \in A_1$ is a generator of the homotopy group of A_1 the image $\gamma_n = f^{n-1}(\gamma)$ is a path in A_n which is not homotopic to a constant. Since all limit functions of subsequences of f^n are constant in A_1 , it follows that the spherical diameter of $\gamma_n \rightarrow 0$ as $n \rightarrow \infty$. For any convergent subsequence f^{n_j} we have either $\gamma_{n_j} \rightarrow \infty$ or $\gamma_{n_j} \rightarrow 0$. Thus at least one of ∞ or 0 is a singleton component of $J(f)$ cut off from any other point of $J(f)$ by certain arbitrarily small curves $\gamma_{n_j} \subset A_{n_j} \subset F(f)$. The boundaries of A_{n_j} are in $J(f)$ and converge to ∞ or 0. If ∞ is a singleton component of $J(f)$, then, since $f(z) \in \mathbf{M}$, the preimages of ∞ , which are also singleton components, are dense in $J(f)$.

For the remaining case we may assume that no sequence $f^{n_j} \rightarrow \infty$ in A_1 and hence that the whole sequence $f^n \rightarrow 0$ in A_1 , that is the domains $A_n \rightarrow 0$ as $n \rightarrow \infty$. Hence,

$0 \in J(f)$, and therefore $A_{n+1} = f(A_n) \rightarrow f(0)$ so that $f(0) = 0$. Then $f(z)$ is analytic in some neighbourhood U of 0. Further, A_n is in U for $n > n_0$ and $A_n \rightarrow 0$ as $n \rightarrow \infty$. This implies that there is some $n > n_0$ such that A_{n+1} is inside A_n , that is, in the component of A_n^c which contains 0. If α_n is the outer boundary of A_n and I is the component of α_n^c which contains 0, then $f(I)$ is a bounded domain whose boundary belongs to $f(\alpha_n) \in \partial A_{n+1}$ which is inside I . Thus $f(I) \subset I$ and (f^n) is analytic and normal in I , but this contradicts the fact that $0 \in J(f)$. The proof of Theorem D is complete.

In order to prove Theorem E we need the following results.

LEMMA 26 (Runge, see for example [41]). *Suppose that K is compact in \mathbf{C} and $f(z)$ is holomorphic on K ; further, let $\epsilon > 0$. Let E be a set such that E meets every component of $\widehat{\mathbf{C}} \setminus K$. Then there exists a rational function R with poles in E such that*

$$|f(z) - R(z)| < \epsilon, \quad z \in K.$$

LEMMA 27 [15]. *Suppose that D is an unbounded plane domain with at least two finite boundary points and that g is analytic in D and satisfies (i) $g(D) \subset D$ and (ii) $g^n(z) \rightarrow \infty$ as $n \rightarrow \infty$, $z \in D$. Then for any z_0 in D there is a constant $k > 0$ such that*

$$\limsup \frac{1}{n} \log \log |g^n(z_0)| \leq k.$$

Further, there is a path γ in D and a constant $A > 1$ such that γ leads to ∞ and $|z|^{\frac{1}{A}} \leq |g(z)| \leq |z|^A$ for all large z on γ .

Proof of Theorem E

Choose $\epsilon > 0$ so that

$$\frac{3}{4} < \prod_1^{\infty} (1 - \epsilon^n) < \prod_1^{\infty} (1 + \epsilon^n) < \frac{3}{2},$$

and a sequence $r_n, n \geq 2$, so that $r_{n+1} > 16r_n$, $r_{n+1} > e^{r_n}$ and $r_2 > 16$. Thus the disc $\overline{D} = \overline{D}(0, 1)$ and the annuli $\overline{B}_n : r_n/3 \leq |z| \leq 3r_n, n \geq 2$, are all disjoint. Then $\delta_n = r_n/r_{n+1}, n \geq 2$, satisfies $0 < \delta_n < 1/16$ and $\delta_n \rightarrow 0$ as $n \rightarrow \infty$.

Now choose positive numbers ϵ_1 and ϵ_{n+1} , $n \in \mathbf{N}$, so small that

$$(1 - 6r_{n+1}\epsilon_{n+1}\delta_{n+1}^{-1})^{-1} < (1 + \epsilon^n)^{\frac{1}{2}}, \quad (4.2)$$

$$r_{n+2} + \epsilon_1 < (1 + \epsilon^n)^{\frac{1}{2}}r_{n+2}, \quad (4.3)$$

$$(1 + 6r_{n+1}\epsilon_{n+1}\delta_{n+1}^{-1})^{-1} > (1 - \epsilon^n)^{\frac{1}{2}}, \quad (4.4)$$

$$r_{n+2} - \epsilon_1 > (1 - \epsilon^n)^{\frac{1}{2}}r_{n+2}, \quad (4.5)$$

$$\epsilon_{n+1} < \frac{1}{2}\epsilon_n, \quad \epsilon_1 < \frac{1}{4}. \quad (4.6)$$

Since $|(1 \pm \epsilon^n)^{\frac{1}{2}} - 1|r_{n+2} \sim \frac{\epsilon^n}{2}r_{n+2} \rightarrow \infty$ as $n \rightarrow \infty$ we may choose ϵ_1 to satisfy (4.3) and (4.5). Then we choose ϵ_{n+1} , $n \in \mathbf{N}$, to satisfy (4.2), (4.4), and (4.6).

Now define $f_1(z) = z^{-1}$. It follows from Lemma 26 that there is a rational function f_{n+1} , $n \geq 1$, with poles only at $r_{n+1}/4$ and ∞ , such that

$$|f_{n+1}(z)| < \epsilon_{n+1} \quad \text{in } \overline{D}(0, r_{n+1}/5) \quad (4.7)$$

and

$$|f_1(z) + \dots + f_{n+1} - \delta_{n+1}z^{-1}| < \epsilon_{n+1} \quad \text{in } B_{n+1}. \quad (4.8)$$

Then f defined by $f(z) = \sum_1^\infty f_n(z)$ is meromorphic, by (4.6) and we have, using (4.7) and (4.8) that

$$|f(z) - z^{-1}| \leq \sum_2^\infty \epsilon_n < \epsilon_1 \quad \text{in } \overline{D}, \quad (4.9)$$

$$|f(z) - \delta_{n+1}z^{-1}| \leq \sum_{j=n+1}^\infty \epsilon_j < 2\epsilon_{n+1} \quad \text{in } B_{n+1}. \quad (4.10)$$

Thus if $1 < \lambda \leq 3$ and $r_{n+1}\lambda^{-1} < |z| < \lambda r_{n+1}$, $n \in \mathbf{N}$, we have from (4.9) and (4.10) that

$$f(z) = \delta_{n+1}z^{-1} + \eta_n, \quad |\eta_n| < 2\epsilon_{n+1},$$

so that $f(z) \in D$ and

$$f^2(z) = \frac{z}{\delta_{n+1}}(1 + \eta_n z \delta_{n+1}^{-1})^{-1} + \eta'_n, \quad |\eta'_n| < \epsilon_1. \quad (4.11)$$

So it follows from (4.2), (4.3), (4.4), and (4.5) that

$$\begin{aligned} & \lambda^{-1}r_{n+1}\delta_{n+1}^{-1}(1+2\lambda r_{n+1}\epsilon_{n+1}\delta_{n+1}^{-1})^{-1} - \epsilon_1 \\ < & |f^2(z)| < \\ & \lambda r_{n+1}\delta_{n+1}^{-1}(1-2\lambda r_{n+1}\epsilon_{n+1}\delta_{n+1}^{-1})^{-1} + \epsilon_1, \end{aligned}$$

and hence

$$\lambda^{-1}r_{n+2}(1-\epsilon^n) < |f^2(z)| < \lambda r_{n+2}(1+\epsilon^n). \quad (4.12)$$

Thus if we set $A_2 = \{z : \frac{1}{2}r_2 < |z| < 2r_2\} \subset B_2$ we find that

$$\begin{aligned} \frac{3}{8}r_{n+2} & < \frac{1}{2}r_{n+2} \prod_1^\infty (1-\epsilon^n) \\ & < |f^{2n}(z)| \\ & < 2r_{n+2} \prod_1^\infty (1+\epsilon^n) \\ & < 3r_{n+2}. \end{aligned}$$

Hence $f^{2n}(z)$ is in B_{n+2} and so $f^{2n}(z) \rightarrow \infty$ in A_2 . Further, $f^{2n}(A_2)$ is in some component $\widetilde{A_{2n+2}}$ of $F(f)$.

Again, using (4.2) in (4.11) we see that for z in B_{n+1}

$$f^2(z) = \frac{z}{\delta_{n+1}}(1+\mu) + \eta'$$

where

$$\begin{aligned} |\mu| & = |(\eta_n z \delta_{n+1}^{-1})(1 + \eta_n z \delta_{n+1}^{-1})^{-1}| \\ & \leq |(6r_{n+1}\epsilon_n \delta_{n+1}^{-1})(1 - 6r_{n+1}\epsilon_n \delta_{n+1}^{-1})^{-1}| \\ & \leq (1 + \epsilon^n)^{\frac{1}{2}} - 1 \end{aligned}$$

and $|\eta'| < \epsilon_1$. It follows inductively that each $f^{2n}(A_2)$ is a region in B_{n+2} which separates 0 and ∞ . Clearly then $\widetilde{A_{2n+2}}$ which contains $f^{2n}(A_2)$ is multiply-connected. Also the components $\widetilde{A_{2n+2}}$ are all different since otherwise we have an unbounded component of $F(f)$ which is invariant under f^2 in which $f^{2n} \rightarrow \infty$. It follows from Lemma 27 that there is then a constant K and a curve Γ which tends to ∞ on which $|f^2(z)| < |z|^K$ for large z . But in any $f^{2n}(A_2)$ we have $|z| < 3r_{n+2}$ and $|f^2(z)| > \frac{3}{8}r_{n+3} > \frac{3}{8}e^{r_{n+2}}$, so no such Γ exists. Finally $\widetilde{A_{2n+1}} = f(\widetilde{A_{2n}})$ is multiply-connected. Further, $\widetilde{A_{2n+1}} \rightarrow 0$ and $\widetilde{A_{2n+2}} \rightarrow \infty$.

4.5 Functions with finitely many poles

We will start this section by giving a theorem of H. Bohr.

THEOREM 4.5.1 [26]. *If $f(z) = \sum_{n=1}^{\infty} a_n z^n$ is analytic in $D(0, 1)$ and for some ρ , $0 < \rho < 1$, $M_f(\rho) = \text{Max}\{|f(z)| : |z| = \rho\}$ satisfies $M_f(\rho) > 1$, then $f(D)$ contains the circle $C(0, r) = \{z : |z| = r\}$ for some $r > C(\rho)$, where $C(\rho)$ is a positive constant which depends only on ρ .*

We wish to have a similar result to Bohr's theorem for functions $f(z)$ which are analytic in $0 < R \leq |z| < \infty$.

THEOREM 4.5.2. *If $f(z)$ is analytic in $0 < R \leq |z| < \infty$ and $M_f(r) \rightarrow \infty$ as $r \rightarrow \infty$, then for all sufficiently large ρ the image $f(A_\rho)$ of $A_\rho = \{z : R \leq |z| \leq \rho\}$ contains some circle $C(0, r) = \{z : |z| = r\}$ where $r \geq cM_f(\rho/2)$ and c is a positive absolute constant.*

We shall use a consequence of Schottky's theorem, see e.g. [17, Lemma 1].

LEMMA 28. *If $g(z)$ is regular in the annulus $A = \{z : \alpha \leq |z| \leq \beta\}$, $\beta/\alpha = \gamma > 1$, if $g(z)$ takes neither value 0 nor 1 in A , and if for some $|z_0| = \sqrt{\alpha\beta}$ one has $|g(z_0)| \leq \mu$, then there is a constant K depending only on γ, μ such that $|g(z)| \leq K$ uniformly on $|z| = \sqrt{\alpha\beta}$.*

Proof of Theorem 4.5.2

I. Let K denote the constant in Lemma 28 when $\gamma = 4$ and $\mu = 2$. Since $\log M_f(r)$ is a convex function of $\log r$, it follows that $M_f(r)$ can have at most one minimum in $[R, \infty)$, at s say, and is increasing for $r > s$.

Since $M_f(r) \rightarrow \infty$ as $r \rightarrow \infty$ we see that there is some $T \geq R$ such that $M_f(r) > M_f(R)$ for $r > T$.

Now choose $\epsilon = 1/2(1 + 3K)$. Then there is a positive ρ_0 such that for $\rho \geq \rho_0$ we have

$$\frac{\epsilon}{4}M_f(\rho/2) > M_f(R) \text{ and } \rho > 4R.$$

Suppose that for $\rho \geq \rho_0$ and for every $r \geq (\epsilon/4)M_f(\rho/2)$ there is some point on $C(0, r)$ which is not in $f(A_\rho)$. In particular there is w' with

$$|w'| = (\epsilon/4)M_f(\rho/2)$$

and w'' with

$$|w''| = (\epsilon/2)M_f(\rho/2)$$

such that $f(z) \neq w', w''$ in A_ρ .

There is some r' in $R \leq r' < \rho/2$ where $M_f(r') = |w'|$ and there is some z' with $|z'| = r'$ and $|f(z')| = M_f(r')$. The point z' lies on a level curve

$$\Gamma = \{z : |f(z)| = |w'|\}.$$

Now Γ cannot meet $|z| = R$ since $(\epsilon/4)M_f(\rho/2) > M_f(R)$. If the component L of $\{z : |f(z)| < |w'|\}$ which contains $\{z : R < |z| < r'\}$ lies inside A_ρ , then we can take Γ to be one of the boundary curves of L which closes in $\overline{A_\rho}$. Since $\arg f(z)$ is monotone on Γ , it then follows that $\arg f(z)$ changes by at least 2π on Γ , that is $f(z)$ would take every value of modulus $|w'|$ at some point on Γ . Thus Γ meets $\{z : |z| = \rho/2\}$ and there is some point z_0 such that $|z_0| = \rho/2$ and $|f(z_0)| = |w'|$.

II. Now consider

$$g(z) = \frac{f(z) - w'}{w'' - w'}$$

which is analytic in $\{z : \rho/4 < |z| < \rho\} \subset A_\rho$ and $g(z) \neq 0, 1$. Using the results in I we have

$$\begin{aligned} |g(z_0)| &\leq \frac{|f(z_0)| + |w'|}{|w''| - |w'|} \\ &= \frac{2|w'|}{|w''| - |w'|} = 2. \end{aligned}$$

It follows from Lemma 28, with $\alpha = \rho/4$, $\beta = \rho$, that $|g(z)| \leq K$ uniformly on $|z| = \sqrt{\alpha\beta} = \rho/2$.

But on $|z| = \rho/2$ we have uniformly

$$\begin{aligned} |f(z)| &\leq |w'| + K|w'' - w'| \\ &\leq |w'| + K(|w''| + |w'|) \end{aligned}$$

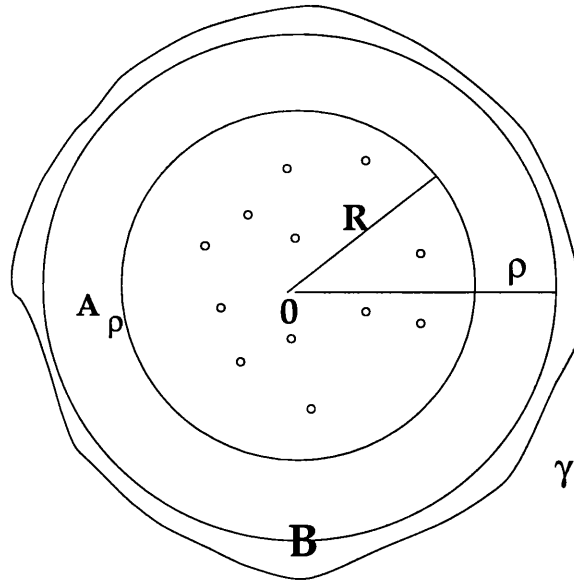

Fig. 4.2: B is the region between $C(0, R)$ and γ

$$\begin{aligned}
 &= M_f(\rho/2)(1 + 3K)(\epsilon/4) \\
 &= \frac{1}{8}M_f(\rho/2)
 \end{aligned}$$

so that $|f(z)| < M_f(\rho/2)$, which is a contradiction. Thus the theorem holds with $c = \epsilon/4$ where $\epsilon = 1/2(1 + 3K)$.

We shall prove Theorem F by using Theorem 4.5.2.

Proof of Theorem F

(i) Take $R > 0$ such that $D(0, R)$ contains the finite set of poles of $f(z)$. Choose ρ so large that $\rho > M_f(R)$ and that $cM_f(\sigma/2) > 2\sigma$ for every $\sigma \geq \rho$, where c is the constant of Theorem 4.5.2. If the theorem is false there is an invariant component G of $F(f)$ and a curve γ which lies in $G \cap \{z : |z| > \rho\}$ and satisfies $n(\gamma, 0) = 1$. Then the annulus $A_\rho = \{z : R \leq |z| \leq \rho\}$ is in the interior of γ .

Let B denote the region between $C(0, R)$ and γ so that $A_\rho \subset B$, see Figure 4.2. The function $f(z)$ is analytic in B , so

$$\partial f(B) \subset f(\partial B) = f(C(0, R)) \cup f(\gamma)$$

where $f(C(0, R)) \subset \overline{D}(0, M_f(R))$ with $M_f(R) < \rho$. Since $f(A_\rho) \subset f(B)$ it follows from Theorem 4.5.2 that $f(B)$ contains some circle $C(0, r)$ such that $r \geq cM_f(\rho/2) > 2\rho$.

The boundary of $f(B)$, which is compact in \mathbf{C} , contains the boundary of the unbounded component of the complement of $f(B)$. Thus the latter, say γ_1 is part of $f(\gamma)$ and is a continuum which lies in $|z| > 2\rho$, and belongs to G .

We may now repeat the above argument but with B replaced by the region between $|z| = R$ and γ_1 , say B_1 and with ρ replaced by 2ρ . Thus $f(B_1)$ has an ‘outer boundary’ γ_2 which is in $|z| > 4\rho$ and belongs to G .

Repeating this argument inductively, there is a simple closed curve γ_n which is part of $f^n(\gamma)$ and contains the disc $D(0, 2^n\rho)$ in its interior. Then there is a compact $K \subset \gamma$ such that $f^n(K) \subset \gamma_n$, for $n \in \mathbf{N}$, therefore $f^n \rightarrow \infty$ on K . Since $f^n \rightarrow \infty$ at some points of γ , it follows that $f^n \rightarrow \infty$ in G .

(ii) We may assume without loss of generality that 0 and 1 are not in G . Let $H = \widehat{\mathbf{C}} \setminus \{0, 1, \infty\}$, γ_n be as above and let $h = \max d_G(z, w) < \infty$ where $z \in \gamma$, $w \in \gamma_1$, and $d_G(z, w)$ denotes the hyperbolic distance in G .

For any $w \in \gamma_n$ we have that $w = f^n(z)$ for some $z \in \gamma$ therefore

$$d_G(w, f(w)) = d_G(f^n(z), f^{n+1}(z)) \leq d_G(z, f(z)) \leq h.$$

Now $f^n(z) \rightarrow \infty$ as $n \rightarrow \infty$, thus for $w \in \gamma_n$ there is some path δ from w to $f(w)$ such that

$$\begin{aligned} h &\geq d_G(w, f(w)) \\ &= \int_{\delta} \rho_G(z) |dz| \end{aligned}$$

where ρ_G is the Poincaré density for G . Since $G \subset H$ we have $\rho_G \geq \rho_H$ and $\rho_H \sim c'/|z| \log |z|$ for some constant c' , as $z \rightarrow \infty$. Now

$$\begin{aligned} h &\geq \int_{\delta} \frac{c' |dz|}{|z| \log |z|} \geq c' \int_{|w|}^{|f(w)|} \frac{d|z|}{|z| \log |z|} \\ &= c' (\log \log |f(w)| - \log \log |w|) \end{aligned} \tag{4.13}$$

so

$$|f(w)| \leq |w|^p, \quad p = e^{\frac{h}{c'}}. \tag{4.14}$$

The inequality (4.14) holds for $w \in \gamma_n$, n large. The function $f(z)$ is analytic in the annulus $R \leq |z| < \infty$, so there are numbers a_j , $j \in \mathbf{Z}$, such that

$$f(z) = \sum_{-\infty}^{\infty} a_j z^j \text{ in } R < |z| < \infty.$$

For an integer $k > p$, the function

$$F(z) = \frac{f(z)}{z^k} = \sum_{-\infty}^{\infty} a_j z^{j-k}$$

is analytic in $R \leq |z| < \infty$. It follows from (4.14) that $\text{Sup}_{\gamma_n} |F(z)| \rightarrow 0$ as $n \rightarrow \infty$. Now the maximum principle implies that $F(z)$ is bounded, say b , thus $|F(z)| < b$ in a neighbourhood of ∞ (outside γ_1). Thus ∞ is a removable singularity of $F(z)$ and a pole of $f(z)$ contrary to the assumption that $f(z)$ is transcendental.

4.6 Orbits which tend to ∞

Proof of Theorem G

This is just part (i) of the proof of Theorem F. We note that we do not use the hypothesis that $\gamma \subset F(f)$, made in Theorem F until we have proved that $f^n(\gamma)$ contains a simple closed curve γ_n which winds around zero and satisfies $d(0, \gamma_n) \rightarrow \infty$. Moreover $\gamma_{n+1} \subset f(\gamma)$ and $A_n = \gamma \cap f^{-n}(\gamma_n)$ is a decreasing family of compact sets whose intersection K is in $\gamma \cap I(f)$.

Proof of Theorem H

Let p_1 be a pole of $f(z)$ of order k and let $D_1 = D(p_1, r_1)$, $r_1 > 0$. It is easy to see that $f(D_1)$ is a neighbourhood of ∞ . Since p_1 is a k -fold pole of $f(z)$, for r_1 sufficiently small there is a simply-connected neighbourhood V_1 of p_1 in D_1 which is mapped locally univalently except at p_1 onto $|f| > R_1$, $R_1 > 1$, for some R_1 ($\overline{V_1}$ to $|f| \geq R_1$). Thus we can find a pole p_2 in $\{|z| > R_1\}$ such that $|p_2| > |p_1|$, and a disk $D_2 = D(p_2, r_2) \subset \{|z| > R_1\}$, r_2 very small. By the preceding argument $p_2 \in V_2$, where V_2 is a simply-connected neighbourhood in D_2 which is mapped locally univalently by f , except at p_2 , to $\{|f| > R_2\}$ for some $R_2 > 2R_1$. We may take a branch of f^{-1} analytic in $\overline{V_2}$ so that $U_1 = f^{-1}(\overline{V_2}) \subset \overline{V_1}$.

Using the same argument we can take a pole p_3 in $\{|z| > R_2\}$ and the disk $D_3 = D(p_3, r_3)$, r_3 very small, such that $p_3 \in V_3$ where V_3 is a simply-connected neighbourhood

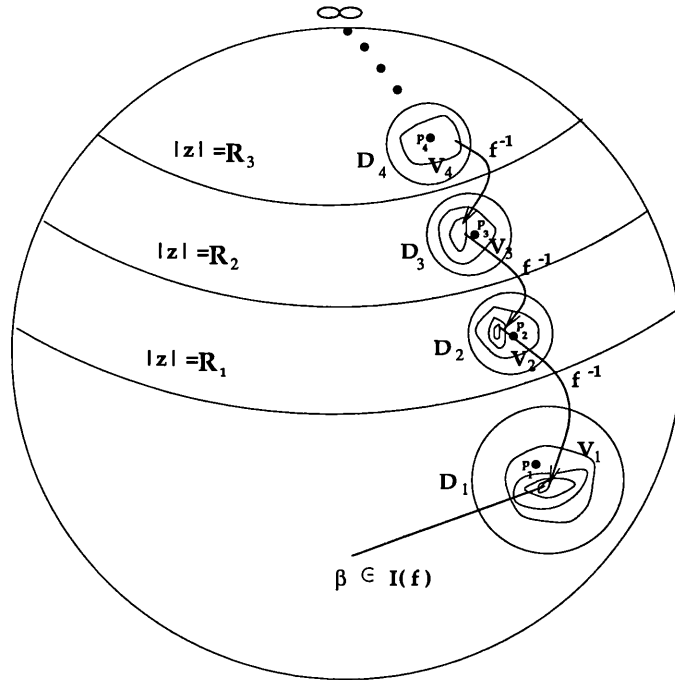

Fig. 4.3: The process

in D_3 which is mapped locally univalently by f , except at p_3 , to $\{|f| > R_3\}$ where $R_3 > 2R_2$. We take a branch of f^{-1} analytic in $\overline{V_3}$ so that $f^{-1}(\overline{V_3}) \subset \overline{V_2}$. Repeating this process, see Figure 4.3, inductively we have $D_n = D(p_n, r_n) \rightarrow \infty$ and $f^{-n}(\overline{V_{n+1}}) = U_n \subset \overline{V_1} \subset D_1$, $n \in \mathbb{N}$. Then $\bigcap U_n \neq \emptyset$ and $\beta \in \bigcap U_n$ implies $f^n(\beta) \in D_{n+1}$. Thus D_1 contains $\beta \in I(f)$. The theorem is proved.

Remark In the above construction we have $p_3 \in V_3$ so that $U_2 = f^{-2}(\overline{V_3})$ contains a point $f^{-2}(p_3) = f^{-3}(\infty)$. In general U_n contains a preimage $f^{-n}(\infty)$. We may choose the r_n so small that $\bigcap U_n$ is a single point β . Since preimages of poles are in $J(f)$ we then have $\beta \in J(f)$.

In the introduction we defined the set $E(f)$ as the set of exceptional points of $f(z)$.

LEMMA 29 (Lemma 1, [14]). *Let $f(z)$ be a transcendental meromorphic function. For any $q \in J(f)$ and any p not in $E(f)$, q is an accumulation point of $O^-(p)$.*

Proof of Theorem I

It follows from Theorem G and H that $I(f) \neq \emptyset$. It is easy to see that $I(f)$ is infinite since for any $z \in I(f)$ all $f^n(z)$, $n \in \mathbb{N}$, are different and in $I(f)$. Thus we can choose three different points β, γ, δ in $I(f)$ such that $f(\beta) = \gamma$ and $f(\gamma) = \delta$. Now take a point

α in the Julia set and let V be a neighbourhood of α . Since there are at most two exceptional points in the sense of Lemma 29 there exists a pre-image α^* in V of one of the points β, γ, δ . The point α^* belongs to $I(f)$, so $J(f) \subset \overline{I(f)}$. Now periodic points are dense in $J(f)$ and do not belong to $I(f)$. Hence the interior of $I(f)$ belongs to $F(f)$ so that $J(f) \subset \partial I(f)$.

To prove the opposite inclusion, take a point $\alpha \in \partial I(f)$ and suppose that $\alpha \in F(f)$. Let $V \subset F(f)$ be a neighbourhood of α . Then V contains points of $I(f)$ and all f^n are analytic in V and $f^n \rightarrow \infty$ in V . This implies that $V \subset I(f)$ and contradicts the assumption that $\alpha \in \partial I(f)$.

Proof of Theorem J

(i) First suppose that $f(z)$ has only finitely many poles. Choose positive ρ so large that $\gamma = C(0, \rho)$ satisfies the assumption of Theorem G. Let γ_n, A_n, K be as in the proof of Theorem G, so that $K \subset I(f)$. If K meets $J(f)$ we are finished, so assume that $K \subset F(f)$. Since K is compact it is covered by some finite set D_1, D_2, \dots, D_p of components of $F(f)$. Since $K = \bigcap_{n=0}^{\infty} A_n$ with A_n compact we have $A_n \subset \bigcup_{i=1}^p D_i \subset F(f)$, $n > n_0$. But $f^n(A_n) = \gamma_n$ so that $\gamma_n \subset F(f)$.

Let G_n denote the component of $F(f)$ which contains γ_n so that $f(G_n) = G_{n+1}$, since $f(\gamma_n)$ meets γ_{n+1} . If some $G_n = G_{n+1}$, then G_n is an unbounded invariant component of $F(f)$ which contains arbitrarily large curves γ_m , $m \geq n > n_0$, which wind round zero. By Theorem F this is impossible.

It follows that all G_n are different and hence bounded components of $F(f)$. Since $d(0, \gamma_n) \rightarrow \infty$ as $n \rightarrow \infty$ we see that $f^n \rightarrow \infty$ in each G_k and also that $G_n \rightarrow \infty$ as $n \rightarrow \infty$. But $f(\partial G_n) = \partial f(G_n)$ so that each $\partial G_k \subset I(f)$ and of course belongs to $J(f)$. The proof is complete in this case.

(ii) If $f(z)$ has infinitely many poles the proof follows from the remark at the end of the proof of Theorem H, where $\beta \in I(f) \cap J(f)$.

4.7 Completely invariant domains

Proof of Theorem K

Suppose that $F(f)$ has two mutually disjoint completely invariant domains G_1 and G_2 (possibly others too). Then G_i , $1 \leq i \leq 2$ are simply-connected and bounded [16, Lemma 4.3].

Take a value α in G_1 such that $f(z) = \alpha$ has infinitely many simple roots z_i ($f'(z) = 0$ at only countably many z so we have to avoid only countably many choices of α). All z_i are in G_1 .

Similarly take β in G_2 such that $f(z) = \beta$ has infinitely many simple roots z'_i in G_2 . By Gross' star theorem [42] we can continue all the regular branches g_i of f^{-1} such that $g_i(\alpha) = z_i$, along almost every ray to ∞ without meeting any singularity (even algebraic). Thus we can move $\beta \in G_2$ slightly if necessary so that all g_i continue to β analytically along the line l , which joins α and β . The images $g_i(l)$ are disjoint curves joining z_i to z'_i . Denote $g_i(l) = \gamma_i$. Note that γ_i is oriented from z_i to z'_i .

The branches f^{-1} are univalent so γ_i are disjoint simple arcs. Different γ_i are disjoint since γ_i meets γ_j at say w_0 only if two different branches of f^{-1} become equal with values w_0 which can occur only if f^{-1} has branch point at $f(w_0)$ in l , but this does not occur.

Take γ_1 and γ_2 . Since G_1 is a domain we can join z_1 to z_2 by an arc δ_1 in G_1 and similarly z'_1 to z'_2 by an arc δ'_1 in G_2 . If δ'_1 is oriented from z'_1 to z'_2 , let p' be the point where, for the first time, γ_1 meets δ'_1 and q' be the point where, for the first time, γ_2 meets δ'_1 . If δ_1 is oriented from z_1 to z_2 , let p be the point where, for the last time, γ_1 meets δ_1 and q be the point where, for the last time, γ_2 meets δ_1 . These might look like Figure 4.4.

Denote by β_1 the part of δ_1 which joins the points p and q , by β'_1 the part of δ'_1 which joins the points p' and q' , by $\widehat{\gamma}_1$ the part of γ_1 which joins the points p and p' , oriented from p to p' , and by $\widehat{\gamma}_2$ the part of γ_2 which joins the points q and q' , oriented from q to q' . Then $\widehat{\gamma}_1 \beta'_1 \widehat{\gamma}_2^{-1} \beta_1^{-1}$ is a simple closed curve Γ_1 with an interior A_1 . We assert that the function $f(z)$ has a pole in A_1 .

Suppose that $f(z)$ is analytic in A_1 , then $f(A_1)$ is a bounded set and the frontier of $f(A_1)$ is contained in $f(\Gamma_1)$ and hence in $f(\beta_1) \cup f(\beta'_1) \cup l$.

The the curves $f(\beta_1)$ and $f(\beta'_1)$ are closed curves lying in G_1 and G_2 respectively. Thus $f(\beta_1)$ and $f(\beta'_1)$ are mutually disjoint.

Consider the unbounded component H of the complement of $f(\beta_1) \cup f(\beta'_1)$. The component H meets l and in fact if a is the last point of intersection of l with $f(\beta_1)$ and b the first point of the intersection of l with $f(\beta'_1)$ the segment ab of l is a cross cut of

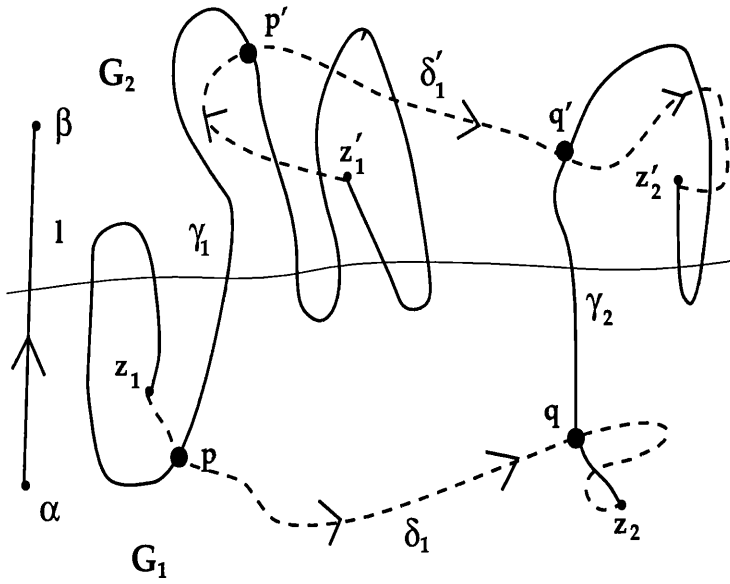

Fig. 4.4: The arcs $\gamma_1, \gamma_2, \delta_1$ and δ'_1

H whose end points belong to different components of the frontier of H . It follows that ab does not disconnect H . Now in fact a point w of ab ($\neq a$ or b) is the image of $f(z)$ of an interior point z in the arc $\widehat{\gamma_1}$ of Γ_1 . In the neighbourhood of z and inside Γ_1 the function takes an open set of values near w , some of which lie off l and in $H \setminus (ab)$. Then since the frontier of A_1 is contained in $f(\beta_1) \cup f(\beta'_1) \cup l$ we see that $f(A_1)$ must contain the whole of the unbounded set $H \setminus (ab)$. This contradiction proves that there is a pole in A_1 . So far the argument closely resembles that of [7].

Now for large j , γ_j does not meet A_1 . Pick another pair, say γ_3 and γ_4 , which do not meet $A_1 \cup \Gamma$. Thus the points z_3, z_4 are in G_1 and the points z'_3, z'_4 are in G_2 such that γ_3 joins z_3 to z'_3 , oriented from z_3 to z'_3 , and γ_4 joins z_4 to z'_4 , oriented from z_4 to z'_4 .

It follows from Theorem 7.1 in [60, p.151] that if z_3, z_4 are separated in G_1 by Γ_1 , then they are separated in G_1 by a component of $G_1 \cap \Gamma_1$, that is by a cross cut ρ , part of Γ_1 , in G_1 . Thus z_3, z_4 belong to different components of $G_1 \setminus \rho$ one inside Γ_1 , in A_1 say P_1 , and the other outside Γ_1 , say P_2 , so we can take $z_3 \in P_1$ and $z_4 \in P_2$. But z_3 is outside A_1 by assumption. Hence we may join z_3 to z_4 by an arc δ_2 in G_1 which does not meet Γ_1 or A_1 . Similarly we can join z'_3 to z'_4 by an arc δ'_2 in G_2 without meeting Γ_1 or A_1 .

Repeating the argument given before to construct the Jordan curve Γ_1 , we can construct another Jordan curve Γ_2 , composed of arcs of $\gamma_3, \gamma_4, \delta_2, \delta'_2$, which does not meet Γ_1 or A_1 . Then the interior A_2 of Γ_2 satisfies $A_1 \cap A_2 = \emptyset$ and A_2 contains a pole of

$f(z)$.

By induction we can construct a sequence of Jordan curves Γ_i of the same type as Γ_1 , with interior A_i such that the sets $(\Gamma_i \cup A_i)$ are disjoint for different i . Having constructed $\Gamma_1, \dots, \Gamma_i$ we choose $\gamma_{2i+1}, \gamma_{2i+2}$ disjoint from $\overline{A_1} \cup \dots \cup \overline{A_i}$ and can join the ends z_{2i+1}, z_{2i+2} in G_1 without meeting $\Gamma_1 \cup \dots \cup \Gamma_i$ and z'_{2i+1}, z'_{2i+2} in G_2 without meeting $\Gamma_1 \cup \dots \cup \Gamma_i$. Each A_i contains a pole. Thus if $F(f)$ contains more than one completely invariant component, then $f(z)$ has infinitely many poles. The theorem is proved.

4.8 Singularities of f^{-1} of a transcendental meromorphic function f

We recall that the singular values of the inverse f^{-1} of a meromorphic function consist of algebraic branch points or critical values together with the asymptotic values along paths which tend to ∞ . The latter are known as transcendental singularities.

Let $B_j = \{z : f^j \text{ is not meromorphic at } z\}$, so that $B_0 = \emptyset$, $B_1 = \{\infty\}$, and $B_j = \{\infty\} \cup f^{-1}(\infty) \cup \dots \cup f^{-(j-1)}(\infty)$ in general.

Denote $E_n(f) = \{\text{singularities of } f^{-n}\}$, $n \in \mathbf{N}$, so that $E_1(f)$ is the set of singularities of $f^{-1}(z)$. Then as shown in [44, Theorem 7.1.2],

$$f^{n-1}(E_1(f) \setminus B_{n-1}) \subseteq E_n(f) \subseteq \bigcup_{j=0}^{n-1} f^j(E_1(f) \setminus B_j).$$

Thus the set $E(f) = \{w \in \widehat{\mathbf{C}} : \text{for some } n \in \mathbf{N}, f^{-n} \text{ has a singularity at } w\}$ is given by $E(f) = \bigcup_{j=0}^{\infty} f^j(E_1(f) \setminus B_j)$

Define by $E'(f)$ the set of points which are either accumulation points of $E(f)$ or are singularities of some branch of f^{-n} for infinitely many values of n .

THEOREM 4.8.1 (Theorem 7.1.3 [44]). *Let $f(z)$ be a meromorphic function. Any constant limit function of a subsequence of f^n in a component of $F(f)$ belongs to the set $E(f) \cup E'(f)$.*

For rational functions $E(f) \cup E'(f)$ may be replaced by $E'(f)$. The result was proved by Fatou [39, Chapter 4, p.60,] for rational maps and modified by Baker [6] for transcendental entire functions. Bergweiler et al. [24] obtained a stronger result for entire functions. A more general result, which applies to certain classes of functions

meromorphic outside a compact totally disconnected set of essential singularities, was proved by Herring [44].

THEOREM 4.8.2 (Theorem 7.1.4 [44]). *If $f(z)$ is a meromorphic function and $C = \{U_0, U_1, \dots, U_{p-1}\}$ is a cycle of Siegel discs or Herman rings of $F(f)$, then for each j , $\partial U_j \subset E(f) \cup E'(f)$. Further, in any attracting or parabolic cycles the limit functions belong to $E'(f)$.*

This was proved by Fatou [39, § § 30-31] for rational functions and the proof in fact remains valid in our case.

We remark as a corollary (see e.g [44, Theorem 7.1.7]), if $E(f) \cup E'(f)$ has an empty interior and connected complement, then no subsequence of f^n can have a non-constant limit function in any component of $F(f)$.

As we shall see in the example of the next section, these results can be useful in proving the non-existence of wandering components of $F(f)$ in cases where the obvious generalisation of Sullivan's theorem does not apply.

4.9 Examples

Example 1. If $f \in \mathbf{E}$ is such that $F(f)$ has an unbounded component then every component of $F(f)$ is simply-connected and $J(f)$ has no singleton components. These results no longer hold if $f(z)$ is allowed to have even one pole. We show that if $\epsilon = 10^{-2}$, $a = 1 + i\pi$, and $f(z) = z + 2 + e^{-z} + \frac{\epsilon}{z-a}$, then $F(f)$ has a multiply-connected unbounded invariant component H' , which contains H (to be defined below), in which $f^n \rightarrow \infty$.

It follows from [16] that the connectivity of H' is infinite and from Chapter 2, Section 2.8, that singleton components are everywhere dense in $J(f)$. We can show explicitly that for some $x_0 < 0$ the line $S = \{z : z = x + i\pi, -\infty < x \leq x_0\}$ is outside H' , which verifies the assertion of Theorem *F*.

Let $V_\delta = \{z : |z - a| \leq \delta\}$ with $\delta = 0.1$ and let $G = \{z : \operatorname{Re} z \geq 1/2\}$. We can define the domain H as follows: $H = G \cap V_\delta^c$, see figure 4.5. Thus H is unbounded and multiply-connected.

We shall prove that H is an invariant domain, that is, $f(H) \subset H$. Let z be in H and choose $\epsilon = 0.01$. If we look at $|e^{-z} + \epsilon/(z - a)|$ we have

$$\left| e^{-z} + \frac{\epsilon}{z-a} \right| \leq |e^{-z}| + \left| \frac{\epsilon}{z-a} \right| \leq e^{-\frac{1}{2}} + \frac{\epsilon}{\delta}. \quad (4.15)$$

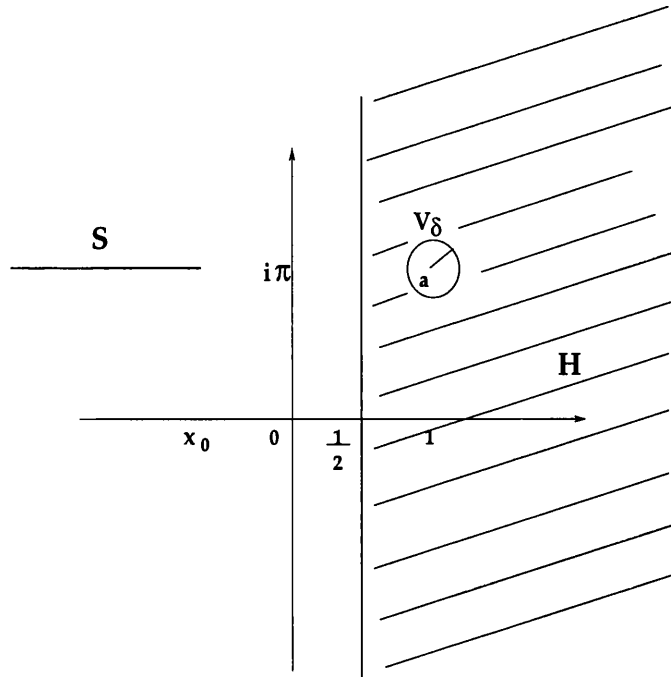

Fig. 4.5: The domain H

Thus

$$\begin{aligned} \operatorname{Re}\left\{z + 2 + e^{-z} + \frac{\epsilon}{z-a}\right\} &\geq \operatorname{Re}(z + 2) - \left|e^{-z} + \frac{\epsilon}{z-a}\right| \\ &\geq \frac{1}{2} + 2 - \left(e^{-\frac{1}{2}} + \frac{\epsilon}{\delta}\right) \approx 1.793. \end{aligned}$$

Hence $f(H) \subset H \subset F(f)$. By similar arguments we can see that $f^n \rightarrow \infty$. Let z be in H as before and take $f(z) - z = 2 + e^{-z} + \frac{\epsilon}{z-a}$. It follows from (4.15) that

$$\operatorname{Re}\{f(z) - z\} \geq 2 - e^{-\frac{1}{2}} - \frac{\epsilon}{z-a} \approx 1.29 > 1.$$

Thus $\operatorname{Re}\{f^n(z) - z\} > n \rightarrow \infty$, $n \in \mathbb{N}$, and $f^n(z) \rightarrow \infty$.

The component H' of $F(f)$ which contains H thus has the properties claimed.

Since $f(x + i\pi) = x + i\pi + 2 - e^{-x} + \frac{\epsilon}{(x-1)}$ we see that the segment $S = \{z : z = x + i\pi, -\infty < x \leq x_0\}$ is invariant under $f(z)$, for some $x_0 < -3$. Suppose that $z = x' + i\pi \in H' \cap S$. Then it follows from Lemma 27 that there is some constant K such that $\log \log |f^n(z)| < Kn$. For a constant $A > e^{2K}$ we have $|\operatorname{Re} f(x + i\pi)| > |x|^A$ for $x < x_1 < x_0$ say. Since $f^n(x') \rightarrow \infty$ we have for some $p \in \mathbb{N}$ that $\operatorname{Re} f^q(x' + i\pi) < -x_1$, $q \geq p$. It follows that for $n > p$

$$|\operatorname{Re} f^n(x' + i\pi)| > x_1^{A^{n-p}} > e^{\epsilon(n-p) \log A}.$$

Thus $\log \log |f^n(z)| > Kn$ if n is sufficiently large. This contradiction proves that H' does not meet S .

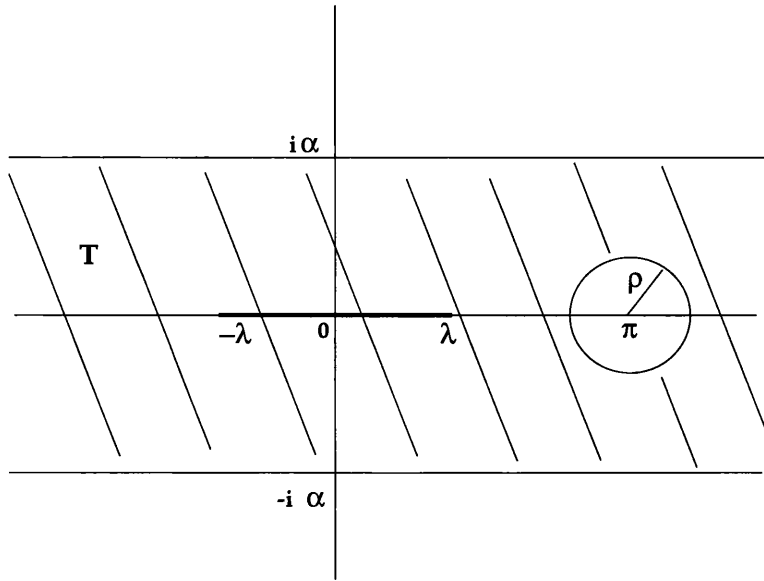

Fig. 4.6: $T = S \cap \{z : |z - \pi| > \rho\}$

Example 2. For the function $f(z) = \lambda \sin z - \frac{\epsilon}{z - \pi}$, $0 < \lambda < 1$, $\epsilon > 0$, we wish to show that, for sufficiently small ϵ , the Fatou set $F(f)$ is a single completely invariant domain of infinite connectivity. It will follow from Theorem A that singleton components are everywhere dense in $J(f)$ but that $J(f)$ also contains unbounded continua.

We take λ' so that $\lambda < \lambda' < 1$ and α so that $0 < \alpha < 1$ and that $\lambda |\cos z| < \lambda'$ for $z \in S = \{z : |\text{Im} z| < \alpha\}$.

Let ρ satisfy $\rho < \alpha$ and assume that ϵ is so small that $\lambda' \alpha + \epsilon \rho^{-1} < \alpha$. Let $T = S \cap \{z : |z - \pi| > \rho\}$, see Figure 4.6. For $z = x + iy \in T$ we have

$$|f(z) - \lambda \sin x| \leq \lambda |\sin z - \sin x| + \frac{\epsilon}{|z - \pi|} \leq \lambda' \alpha + \epsilon \rho^{-1} < \alpha < 1.$$

Since $\lambda \sin x \in I = [-\lambda, \lambda]$, it follows that $f(z)$ belongs to a compact subset of T . Thus T belongs to an invariant component H of $F(f)$ in which $f^n(z) \rightarrow \beta$ where β is an attracting fixed point of $f(z)$.

Now we consider the singular points of f^{-1} . On any path Γ which tends to ∞ , $\epsilon(z - \pi)^{-1} \rightarrow 0$ and $f(z)$ has a limit l if and only if $\lambda \sin z \rightarrow l$. This is possible only for $l = \infty$. Thus apart from ∞ all singularities of f^{-1} are finite critical values of $f(z)$.

If $f'(z) = 0$ and $|z - \pi| > t = \frac{\pi}{4}$, then

$$|\cos z| < \epsilon \lambda^{-1} t^{-2} < 2\epsilon \lambda^{-1}, \quad \sin z = \pm(1 + \eta)$$

where $|\eta| < 2\epsilon^2 \lambda^{-2}$ (if ϵ was originally chosen small enough). For any such z we have $|f(z) - \lambda \sin z| < 4\epsilon/\pi$ and so $|f(z) \pm \lambda| < 2\epsilon^2 \lambda^{-1} + 4\epsilon/\pi$. Thus we have $f(z) \in T \subset H$

(if ϵ was chosen small enough).

If $f'(z) = 0$ and $|z - \pi| \leq t = \frac{\pi}{4}$, then

$$\frac{\epsilon}{(\lambda e^{\pi/4})} \leq |(z - \pi)^2| = \left| \frac{\epsilon}{(\lambda \cos z)} \right| \leq \sqrt{2}\epsilon/\lambda,$$

since

$$|\cos z| \geq |\cos x \cos hy| \geq 1/\sqrt{2} \quad \text{and} \quad |\cos z| < e^{|y|}.$$

Thus $|z - \pi| < 2^{\frac{1}{4}}\sqrt{\epsilon}\sqrt{1/\lambda}$, $|\sin z| < 2\sqrt{\epsilon}\sqrt{1/\lambda}$, $\epsilon|z - \pi|^{-1} < \sqrt{\epsilon}\sqrt{\lambda}e$, and $|f(z)| < 2\sqrt{\epsilon}\sqrt{\lambda} + \sqrt{\epsilon}\sqrt{\lambda}e$, so that $f(z) \in T \subset H$, provided ϵ was chosen small enough.

Thus the set $E_1(f)$ of the singularities of $f^{-1}(z)$ consists of a countable subset of T whose closure is compact in T , together with ∞ . The same is true of the sets $E(f)$ and $E'(f)$ defined in Section 4.8 and $E(f) \cup E'(f) = \bigcup_0^\infty f^j(E_1(f) \setminus \{\infty\}) \cup \{\beta, \infty\}$. It follows from the results of Section 4.8 that there are no Siegel discs or Herman rings. The only cyclic component of $F(f)$ is H .

All singularities (except ∞) of f^{-1} are contained in H . Take a point z_0 in H and a branch g of f^{-1} such that $g(z_0) \in H$. For any z_1 in H and any branch h of f^{-1} at z_1 we can reach $h(z_1)$ by analytic continuation of g along a path γ from z_0 to z_1 . Now γ is homotopic to a path from γ in $\mathbf{C} \setminus E_1(f)$ to a path γ_1 from z_0 to z_1 , and the continuation of g along γ_1 is h at z_1 . But $g(\gamma_1) \subset F(f)$ and hence $g(\gamma_1) \subset H$. Thus H is completely invariant.

The only possible constant limits of sequences f^{n_k} in Fatou components are β and ∞ . The only possible components G of $F(f)$ other than H will be wandering components in which $f^n \rightarrow \infty$ as $n \rightarrow \infty$. Now we shall show that no such domains G exist.

If there is such G we may suppose that $f^n(G)$ does not meet $D(\pi, \rho)$ for any N , since $f^n(G) \rightarrow \infty$. We must have $\text{Im} f^n \rightarrow \infty$ in G and hence also $f'(f^n) \rightarrow \infty$ and $(f^n)' \rightarrow \infty$ in G . It follows from Bloch's theorem that $f^{n+1}(G)$ contains some discs $D(a, 4\pi)$, where $|\text{Im} a|$ can be taken arbitrarily large, but then on the horizontal diameter of $D(a, \pi)$, $f(z) \sim \frac{1}{2}e^{-ix+y}$ so that $f^{n+2}(G)$ contains some real points, which must be in H . This is impossible, so there are no such domains G .

We have now proved our claim that $F(f) = H$ which is multiply-connected, since π is not in $F(f)$. Then H must in fact have infinite connectivity and by Theorem A the singleton components of $J(f)$ are everywhere dense in $J(f)$. It follows from the corollary to Theorem F that the Julia set $J(f)$ has some components which are not singletons. We

show that this is true of the component which contains ∞ that is, there exist unbounded components of $J(f)$. It follows from Theorem F that if R is sufficiently large positive number, then there is no curve γ in $F(f) \cap \overline{D}(0, R)^c$ which winds round zero. This implies that the component K of the closed set $J(f) \cup \overline{D}(0, R)$, which contains ∞ , is not a singleton.

If $K \subset J(f)$, then we are finished. If not we can take a point w in $K \cap \overline{D}(0, R)$ and for each $\epsilon = \frac{1}{n}$ we may form an ϵ -chain (in the spherical metric) in the connected compact set K which starts at ∞ and ends at w . Denote by A_n the set $\{z_1^n = \{\infty\}, z_2^n, \dots, z_{j(n)}^n\}$ where $z_{j(n)+1}^n$ is the first point of the chain which lies in $\overline{D}(0, R)$. Thus $A_n \subset J(f)$. Since $\infty \in \liminf A_n \neq \emptyset$, we deduce that

$L = \limsup A_n = \{z : \text{a neighbourhood of } z \text{ meets infinitely many } A_n\}$ is connected (see e.g.[73]). But $L \subset J(f)$, $\infty \in L$ and L meets $C(0, R)$. Thus $\{\infty\}$ is not a singleton component of $J(f)$, that is $J(f)$ has an unbounded component.

For $g(z) = \lambda \sin z$ the Julia set contains segments $\pm\{z : z = iy, 0 < y_0 < y < \infty\}$ of the imaginary axis. For $f(z)$ one can show by direct discussion that $J(f)$ contains continua which are 'close to' the above segments. We omit the discussion.

C H A P T E R 5

Boundaries of unbounded Fatou components of entire functions

5.1 Introduction to Chapter 5

An unbounded Fatou component U of a transcendental entire function is simply-connected. This chapter studies the boundary behaviour of the Riemann map Ψ of the disc D to U , in particular the set Θ_∞ of ∂D where the radial limit of Ψ is ∞ .

If U is not a Baker domain and ∞ is accessible in U , then Θ_∞ is dense in ∂D . If U is a Baker domain in which f is not univalent, $\overline{\Theta_\infty}$ contains a non-empty perfect subset of ∂D . Examples show that Θ_∞ may be either countably infinite or residual in ∂D . The function $f(z) = z + e^{-z}$ leads to a component U with a particularly interesting prime end structure.

Suppose that $f(z)$ is a non-linear entire function with iterates $f^n(z)$, $n \in \mathbf{N}$, and Fatou set $F(f)$ such that $F(f)$ contains an unbounded component U . (For basic results about the iteration of entire functions see e.g. [21]). Then U is necessarily simply-connected [8]. We shall consider the case when U is periodic; indeed it suffices to consider the case when U is invariant under $f(z)$. The dynamics of $f(z)$ in U then falls into four cases.

(i) There exists $z_0 \in U$ with $f(z_0) = z_0$ and $|f'(z_0)| < 1$. Then every point $z \in U$ satisfies $f^n(z) \rightarrow z_0$ as $n \rightarrow \infty$. The point z_0 is called an attractive fixed point and U is called the immediate attracting basin of z_0 .

(ii) There exists $z_0 \in \partial U$, $z_0 \neq \infty$ with $f(z_0) = z_0$ and $f'(z_0) = 1$. Every point $z \in U$ satisfies $f^n(z) \rightarrow z_0$ as $n \rightarrow \infty$. The point z_0 is called either a fixed point of multiplier one or a parabolic point and U is called a parabolic basin.

(iii) There exists an analytic homeomorphism $\psi: U \rightarrow D$ where D is the unit disc such that $\psi(f(\psi^{-1}(z))) = e^{2\pi i\alpha}z$ for some $\alpha \in \mathbf{R} \setminus \mathbf{Q}$. In this case, U is called a Siegel disc.

(iv) For every $z \in U$, $f^n(z) \rightarrow \infty$ as $n \rightarrow \infty$. In this case the domain U is called a Baker domain.

It is natural to study U and its boundary in connection with the Riemann map $\Psi : D = D(0, 1) \rightarrow U$. R. L. Devaney and L. R. Goldberg [30] examined the case when $f(z) = \lambda e^z$, $\lambda = te^{-t}$, $|t| < 1$, for which $F(f) = U$ is a single unbounded component, which contains the attracting fixed point t . They described the structure of ∂U , which in this case is the whole Julia set and consists of a Cantor set of curves. They showed that the Riemann map Ψ , normalized by $\Psi(0) = t$, is highly discontinuous on ∂D although the radial limit

$$\Psi(e^{i\theta}) = \lim_{r \rightarrow 1^-} \Psi(re^{i\theta})$$

exists (possibly $= \infty$) for every $e^{i\theta} \in \partial D$.

For $e^{i\theta} \in \partial D$ and g analytic in D the cluster set $C(g, e^{i\theta})$ is the set of all $w \in \widehat{\mathbb{C}}$ for which there exist sequences z_n in D such that $z_n \rightarrow e^{i\theta}$ and $g(z_n) \rightarrow w$ as $n \rightarrow \infty$. If in the previous definition we restrict z_n to lie on the radius from 0 to $e^{i\theta}$ we obtain the radial cluster set $C_\rho(g, e^{i\theta})$. The cluster sets $C(g, e^{i\theta})$ and $C_\rho(g, e^{i\theta})$ are either a continuum or a single point (see e.g. [29]). I.N. Baker and J.W. Weinreich [19] proved the following result.

THEOREM A. *If $f(z)$ is transcendental entire and if U is an unbounded invariant component of $F(f)$, then in cases (i), (ii), and (iii) listed above, $\infty \in C(\Psi, e^{i\theta})$ for every $e^{i\theta} \in \partial D$, where Ψ is a Riemann map of D onto U .*

It was also shown in [19] that Theorem A no longer holds in general when $f(z)$ falls under case (iv), i.e. when $f^n \rightarrow \infty$ in U . An example was given where $f^n \rightarrow \infty$ in U and ∂U is a Jordan curve, so that each $C(f, e^{i\theta})$ is a different singleton. This was shown to occur for $f(z) = z + \gamma + e^{2\pi iz}$ for some choices of the real constant γ . W. Bergweiler [23] showed that $2 - \log 2 + 2z - e^z$ has the same property.

Masashi Kisaka [50] studied the set

$$\Theta_\infty = \{e^{i\theta} : \Psi(e^{i\theta}) \text{ exists and } = \infty\},$$

and obtained an analogue of Theorem A under a number of further assumptions.

Let $N = (\text{sing } f^{-1})$ denote the set of singular values of the inverse function f^{-1} of f , that is the critical values and asymptotic values of f . Write

$$P(f) = \overline{\bigcup_{n=0}^{\infty} f^n(N)}. \quad (5.1)$$

Kisaka proves the following two theorems.

THEOREM B. *Let U be an unbounded invariant component of $F(f)$ of a transcendental entire function f , $\Psi : D \rightarrow U$ be a Riemann map and $P(f)$ be as in (5.1).*

Suppose that there exists a finite point $q \in \partial U$ with $q \notin P(f)$ and a continuous curve $C(t) \subset U$ ($0 \leq t < 1$) such that $C(t) \rightarrow q$ as $t \rightarrow 1$ and $f(C) \supset C$. Suppose further that in the cases when U is (i) an attracting basin, (ii) a parabolic basin or (iii) a Siegel disc the point ∞ is accessible in U . If U is (iv) a Baker domain suppose that f/U is not univalent.

Then the set Θ_∞ is dense in ∂D in the case (i), (ii) or (iii). In the case of (iv), the closure $\overline{\Theta}_\infty$ of Θ_∞ contains a certain perfect set in ∂D . In particular, $J(f)$ is disconnected in all cases.

THEOREM C. *Let U , f and Ψ be as in Theorem B. Suppose that U is either an attracting basin or a parabolic basin and $\infty \in \partial U$ is accessible. If there exist a point $q \in \partial U$ and a continuous curve $C(t) \subset U$ ($0 \leq t \leq 1$) such that $C(t) \rightarrow q$, $t \rightarrow 1$ and $f(C) \supset C$, or if there exist two pairs of q_i and C_i ($i = 1, 2$) with the same property as above, then $J(f)$ is disconnected.*

We shall remove some of the assumptions in Theorems B and C. In fact the only assumption beyond those of Theorem A is that ∞ should be an accessible boundary point of U . It seems an interesting open problem whether ∞ might not be accessible in U .

THEOREM 5.1.1. *If $f(z)$ is a transcendental entire function and U is an unbounded invariant component of $F(f)$, such that ∞ is accessible in U along some path Γ in U , and U is either an attracting basin, a Siegel disc, or a parabolic basin, then Θ_∞ is dense in ∂D .*

THEOREM 5.1.2. *If $f(z)$ is a transcendental entire function and U is an unbounded invariant component of $F(f)$, which is a Baker domain, such that f/U is not univalent, then $\overline{\Theta}_\infty$ contains a non-empty perfect set in ∂D .*

Remark 1. It is automatically true in Theorem 5.1.2 that ∞ is accessible in U .

COROLLARY 5.1.3. *Under the assumptions of Theorem 5.1.1 and Theorem 5.1.2 the boundary of U and $J(f)$ are disconnected sets of \mathbb{C} .*

The Riemann map Ψ conjugates f and its iterates as maps of U to an inner function g and its iterates as maps of $D(0, 1)$. In Section 5.2 and 5.3 we collect some results about inner functions which are used in the proofs of Theorem 5.1.1 and Theorem 5.1.2, Section 5.4.

One may ask whether the three cases listed in Theorem 5.1.1 can arise. For $f(z) = \lambda e^z$, $0 < \lambda < e^{-1}$, the set $U = F(f)$ is a single unbounded attracting basin. It is easy to see that U contains a half-plane so that ∞ is accessible in U . Putting $\lambda = e^{-1}$ in λe^z the same results hold except that U is now an unbounded parabolic basin in which ∞ is accessible. In the course of proving Theorem 5.5.1 we show that $f(z) = ze^{-z}$ gives another parabolic example.

The case of a Siegel disc is more difficult. M. Herman [45] showed that we may choose the constant a so that e^{az} has a Siegel disc U , whose rotation number satisfies a Diophantine condition and that U is then unbounded. P.J. Rippon [69] gives a fairly simple proof that almost all λ such that $|\lambda| = 1$ the function $e^{\lambda z} - 1$ has an unbounded Siegel disc. These proofs seem, however, to give no information as to whether ∞ is accessible from within the disc.

The necessity in Theorem 5.1.2 of the condition that f/U is univalent follows from the examples quoted after the statement of Theorem A, for instance $f(z) = 2 - \log 2 + 2z - e^z$ which has an unbounded invariant domain U in which $f^n \rightarrow \infty$ while the corresponding set Θ_∞ is a singleton.

In Section 5.5 we give an example of an entire function $f(z) = z + e^{-z}$ which has an (unbounded) invariant Baker domain U in which $f(z)$ is conjugate to the self-map $g(z) = (3z^2 + 1)/(3 + z^2)$ of the unit disc, so that Theorem 5.1.2 applies to f . In fact $\overline{\Theta}_\infty = \partial D$ (Theorem 5.5.2).

Now recall (see e.g. [29]) that for our Riemann map $\Psi : D \rightarrow U$, the point $e^{i\theta} \in \partial D$ is said to correspond to a prime-end of Types 1 to 4 as follows.

- Type 1 $C_\rho(\Psi, e^{i\theta}) = C(\Psi, e^{i\theta})$ a singleton,
- Type 2 $C_\rho(\Psi, e^{i\theta})$ a singleton, $\neq C(\Psi, e^{i\theta})$,
- Type 3 $C_\rho(\Psi, e^{i\theta}) = C(\Psi, e^{i\theta})$ not a singleton, and
- Type 4 $C_\rho(\Psi, e^{i\theta})$ not a singleton, $\neq C(\Psi, e^{i\theta})$.

Let E_i denote the set of $e^{i\theta}$ in D which correspond to prime ends of U of Type i ,

$1 \leq i \leq 4$.

In Section 5.6 we show that for the function $f(z) = z + e^{-z}$ and the Baker domain described in Section 5.5 the set Θ_∞ is countable, and further, for this U we have $E_1 = \emptyset$, $\Theta_\infty \subset E_2$, while E_3 is a residual subset of ∂D . This same example gives a natural dynamical example of another result in prime end theory. The notion of asymmetric prime end is defined in [29] and it is known that the set of asymmetric prime ends of any simply-connected domain is countable. In the preceding example every $e^{i\theta} \in \Theta_\infty$ corresponds to an asymmetric prime end, so that U has a dense countable set of asymmetric prime ends. These results are contained in Theorems 5.6.1-5.6.4. It is interesting to note that the iteration of $f(z) = z + e^{-z}$ arises from applying Newton's method to solve the equation $e^{-e^z} = 0$.

In Section 5.7 we note some further examples where Θ_∞ is countable. This is not, however, the case for the example $f(z) = \lambda e^z$, $0 < \lambda < e^{-1}$, $U = F(f)$ discussed above. The result of R.L Devaney and L.R. Goldberg [30] is equivalent to statement that in this case $\partial D = E_1 \cup E_2$, $E_3 = \emptyset$. From Theorem A we have $E_1 \subset \Theta_\infty$ while (see e.g. [29]) $E_1 \cup E_3$ is residual for any simply-connected domain. Thus Θ_∞ is a residual subset of ∂D for the example of R.L Devaney and L.R. Goldberg.

Finally in Section 5.7 we examine a class of functions which include $f(z) = z + 1 + e^{-z}$ and show that all these functions have a Baker domain for which $\overline{\Theta}_\infty = \partial D$. Noting these and the other cases of Theorem 5.1.2 which have been computed suggests the open problem:

With the assumptions of Theorem 5.1.2 is it necessarily the case that $\overline{\Theta}_\infty = \partial D$?

In Section 5.8 we give a new proof of the result of R.L Devaney and L.R. Goldberg.

5.2 Lemmas on inner functions

Let $D = D(0, 1)$ and $g : D \rightarrow D$ be an analytic function. Then the radial limit $g(e^{i\theta})$ exists a.e. on ∂D . If $|g(e^{i\theta})| = 1$ a.e. then g is called an inner function.

LEMMA 30 [29, Theorem 5.4]. *If g is an inner function then for any singularity $e^{i\theta_0}$ of g we have $C(g, e^{i\theta}) = \overline{D}$.*

LEMMA 31 [61, p.36]. *If g is an inner function, if $D(\alpha, \rho) \subset D$, and if $e(w, w_0)$ is an analytic function element of the inverse function of $g(z)$ such that $w_0 \in D(\alpha, \rho)$, then*

there exists some path γ which joins w_0 to α inside $D(\alpha, \rho)$ such that $e(w, w_0)$ can be continued analytically along γ , except perhaps at α .

LEMMA 32 [61, p.34]. *If g is analytic and $|g(z)| < 1$ in D , and if E_1 is a set on ∂D such that for all $e^{i\theta} \in E_1$ we have $|g(e^{i\theta})| = 1$ then the set E_2 of values $g(e^{i\theta})$, $e^{i\theta} \in E_1$ satisfies $m^*(E_2) > 0$ provided $m_*(E_1) > 0$, where m^* and m_* denote outer and inner Lebesgue measure respectively.*

LEMMA 33. *If g is an inner function then all iterates g^n , $n \in \mathbf{N}$, are inner functions.*

Proof. If g and h are inner then $k = h(g) : D \rightarrow D$ and $g(e^{i\theta})$, $k(e^{i\theta})$ exist a.e. If $|k(e^{i\theta})| < 1$ on a set E_1 of positive measure we can assume $|g(e^{i\theta})| = 1$ on E_1 , $g(E_1) = E_2$ then has positive outer measure. $e^{i\phi} \in E_2$ is the radial limit $g(e^{i\theta})$, $e^{i\theta} \in E_1$ say, so there is a path to $e^{i\phi}$ in D on which $h(z)$ has the asymptotic value $k(e^{i\theta})$. But then also $h(e^{i\phi}) = k(e^{i\theta})$ which has modulus less than 1. Since $m^*(E_2) > 0$ this contradicts the assumption that h is inner. Thus $h(g)$ is inner. Lemma 33 follows by induction.

DEFINITION. *A Stolz angle at $\rho \in \partial D$ is of the form*

$$\Delta = \{z \in D : |\arg(1 - \bar{\rho}z)| < \alpha, |z - \rho| < \psi \text{ (} 0 < \alpha < \pi/2, \psi < 2 \cos \alpha)\}.$$

If $\ell: \ell(t), 0 \leq t < 1$, is a path in D and $\lambda \in \partial D$, we write $\ell \rightarrow \lambda$ if $\ell(t) \rightarrow \lambda$ as $t \rightarrow 1$.

LEMMA 34. *Let $e^{i\theta_0}$ be a singular point of the inner function g . For any $q \in \partial D$ there exists $\theta_n \rightarrow \theta_0$, $\theta_n \neq \theta_0$, $n \in \mathbf{N}$, so that there is a path ℓ_n , $n \in \mathbf{N}$, which tends to $e^{i\theta_n}$ in D such that $g(\ell_n) = \lambda_n \rightarrow q$ in a Stolz angle.*

Proof. Let I be an interval on ∂D which contains $e^{i\theta_0}$. Since $g(e^{i\theta})$ exists for almost all θ , while by the theorem of the brothers Riesz [68] the set θ for which $g(e^{i\theta})$ has a given value is a set of measure zero, there are $e^{i\alpha}$, $e^{i\beta}$ in I such that $\alpha < \theta_0 < \beta$ and $g(e^{i\alpha})$, $g(e^{i\beta})$ exist, have modulus 1 and are different from q . Fix r with $0 < r < 1$ and let μ be the curve formed by the union $\{se^{i\alpha}, r \leq s \leq 1\} \cup \{re^{i\theta}, \alpha \leq \theta \leq \beta\} \cup \{se^{i\beta}, r \leq s \leq 1\}$ (see Figure 5.1). Then $g(\mu)$ has distance $\delta > 0$ from q . Let A denote the component of $D \setminus \mu$ whose boundary contains $e^{i\theta_0}$.

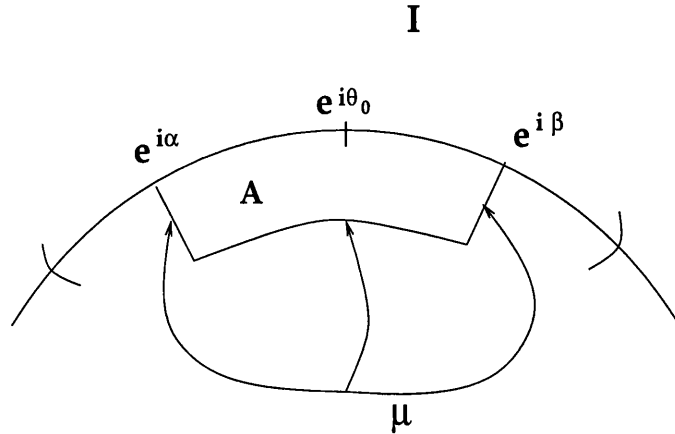

Fig. 5.1: The curve μ

Let Δ be a Stolz angle at q which is contained in $D(q, \delta) \cap D$ and whose bisector is the radius $0q$. Further, let $w_n \in \Delta \cap 0q$, $r_n > 0$ where $n \in \mathbb{N}$, be such that all w_n are different and $w_{n-1} \in D(w_n, r_n) \subset \Delta$, $w_n \rightarrow q$ as $n \rightarrow \infty$. It follows from Lemma 1 that there is some $z' \in A$ such that $w' = g(z')$ is near w_1 in $D(w_2, r_2)$, $w' \neq w_1$ and $g'(z') \neq 0$. The branch e of g^{-1} with $e(w') = z'$ can be continued, by Lemma 31, along some path λ_1 in $D(w_2, r_2)$ to a point w'_2 (near w_2) $\in D(w_3, r_3)$ (see Figure 5.2). By repeating this process we see that e may be continued along a path $\lambda(t)$, $0 \leq t < 1$, which starts at w' , lies in Δ , and tends to q as $t \rightarrow 1$.

Now $e(\lambda)$ is a path in D which starts at z' in A and cannot cross μ , since $g(e(\lambda)) = \lambda$ is inside $D(q, \delta)$. Any limit point p of $e(\lambda(t))$ as $t \rightarrow 1$ satisfies $g(p) = q$, so $p \in \partial D$. If there is more than one such limit point then the set of limit points forms an arc of ∂D on which g has radial limit q . Since this is impossible there exists $e^{i\theta_1} \in \partial D \cap \partial A \subset I$ such that $\ell(t) = e(\lambda(t)) \rightarrow e^{i\theta_1}$ as $t \rightarrow 1$ and $g(\ell(t)) = \lambda(t) \rightarrow q$ in a Stolz angle Δ .

We note that $g(e^{i\theta_1})$ exists and equals q . If $g(e^{i\theta_0})$ either fails to exist or is unequal to q we have $\theta_1 \neq \theta_0$ and the theorem is proved by choice of successively shorter intervals I in the preceding argument.

If $g(e^{i\theta_0}) = q$, take any $q' \in \partial D \setminus \{q\}$. Then there exist $S_n \in \partial D$, $n \in \mathbb{N}$, such that $S_n \rightarrow e^{i\theta_0}$ and $g(S_n) = q'$. We may suppose that $S_n = e^{i\phi_n}$, $\phi_{n-1} < \phi_n < \theta_0$. If g is analytic on the arc $\sigma = [S_{n-1} S_n]$ of ∂D , then $g(\sigma) \supset \partial D$ so that there is a point $e^{i\theta_n} \in \sigma$ where g is analytic with $g(e^{i\theta_n}) = q$. We may then take ℓ_n in the theorem to be a radial path tending to $e^{i\theta_n}$. If on the other hand g is singular at $e^{i\phi_n}$ we may apply the argument of the first part to find a path ℓ_n which tends to some $e^{i\theta_n} \in [S_{n-1} S_n]$ such that $g(\ell_n) \rightarrow q$ in a Stolz angle Δ . The proof is complete.

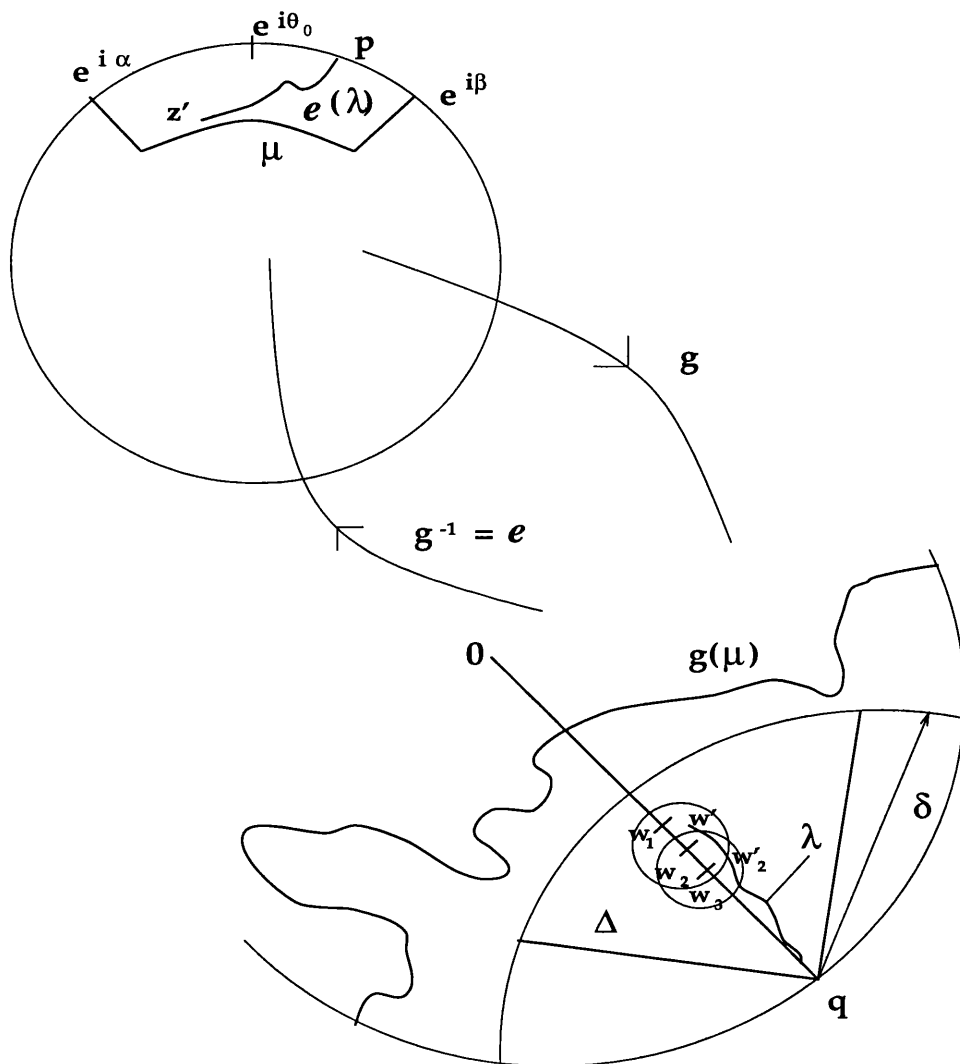

Fig. 5.2: e may be continued along $\lambda(t)$

COROLLARY. With g , θ_n and q as in Lemma 34 we have $g(e^{i\theta_n}) = q$.

DEFINITION. If the inner function g has at least one singularity on ∂D then we define

$$H = \{e^{i\theta} : e^{i\theta} \text{ is a singularity of } g^n \text{ for some } n \in \mathbf{N}\}.$$

LEMMA 35. Any singularity b of g^m is a limit point of H .

Proof. By assumption g has a singularity p on ∂D . Now, taking $b = e^{i\theta_0}$, and $q = p$ and applying Lemma 34 to g^m , we see that there is a sequence θ_n such that $\theta_n \neq \theta_0$, $\theta_n \rightarrow \theta_0$, and $g^m(e^{i\theta_n}) = p$.

Thus either $e^{i\theta_n}$ is a singular point of g^m and then $e^{i\theta_n} \in H$ by definition, or g^m is analytic at $e^{i\theta_n}$. In the latter case $C(g^{m+1}, e^{i\theta_n}) = C(g, p) = \overline{D(0, 1)}$ so that g^{m+1} has a singularity at $e^{i\theta_n}$ which by definition is in H . This shows that $b = e^{i\theta_0}$ is a limit point of H .

LEMMA 36. Closure \overline{H} is a non-empty perfect set provided g has at least one singularity on ∂D .

Proof. We assume that g has a singularity on ∂D so that $H \neq \emptyset$. Take $a = e^{i\theta_0}$ in \overline{H} and let I be an open interval on ∂D with $a \in I$. The interval I contains some $b \in H$, so that b is a singularity of say g^m . It follows from Lemma 35 that b is a limit point of H and also of \overline{H} . Hence I contains infinitely many points of \overline{H} therefore a is a limit point of \overline{H} . Thus \overline{H} is a non-empty perfect set in ∂D .

5.3 Dynamics of inner functions

An inner function g may fail to have singularities on ∂D . In this case it follows from the Schwarz reflection principle that g has a continuation to $\widehat{\mathbf{C}}$ which is analytic except for a finite number of poles and therefore rational. For a rational function g the iterates g^n , $n \in \mathbf{N}$, are rational functions and the Fatou set $F(g)$ is the maximal set in which $\{g^n\}$ is a normal family while the Julia set $J(g)$ is $\widehat{\mathbf{C}} \setminus F(g)$. We make the following definition which applies to all inner functions other than Möbius transformations, whether rational or not.

DEFINITION. If g is an inner function which is not a Möbius transformation the Fatou set $F(g)$ is the maximal open set F such that $D \subset F$, that g^n , $n \in \mathbf{N}$, has an analytic

continuation which is meromorphic in F , and (g^n) forms a normal family in F . The Julia set $J(g)$ is $\overline{D} \setminus F(g)$.

We remark that with this definition $F(g)$ is either (i) D or (ii) it consists of D together with $D' = \{z : |z| > 1\}$ and some open subset of ∂D . In the case of rational g this means that in case (i) our definition of $F(g)$ differs from the usual one, which gives $D \cup D'$. We shall not, however, find any confusion arising from this. Moreover $J(g) = \partial D$ will agree with the usual definition for rational inner functions.

If g is a non-rational inner function and $F_1 = \partial D \setminus \overline{H}$ then F_1 is the maximal open subset of ∂D in which all g^n are analytic. If $p \in F_1$ then $p_1 = g(p) \in \partial D$ and if h is the branch of g^{-1} for which $h(p_1) = p$, then for all $n \in \mathbb{N}$, $g^n = g^{n+1}(h)$ shows that $p_1 \in F_1$. Thus $g(F_1) \subset F_1$. Suppose that we have $F_1 \neq \emptyset$. Then $F = D \cup F_1 \cup D'$ is the maximal open set containing D in which all g^n , $n \in \mathbb{N}$, are meromorphic and $g(F) \subset F$. Since $F^c = \overline{H}$ is perfect by Lemma 36, it contains infinitely many points and (g^n) is normal in F by Montel's theorem. Thus $J(g) = \overline{H}$. The latter statement is also true if $F_1 = \emptyset$, which is equivalent to $\overline{H} = \partial D$, $F = D$.

Recalling also well-known results about rational iteration we state the following lemma.

LEMMA 37. *For any non-Möbius inner function g the Julia set $J(g)$ is a perfect (non-empty) subset of ∂D . The Fatou set $F(g)$ satisfies $g(F) \subset F$. In the case of a non-rational inner function we have $J(g) = \overline{H}$, where H is the set defined above before Lemma 35.*

We describe two cases when $J(g) = \partial D$. These will be used in proving the main theorem.

LEMMA 38. *Suppose that g is a non-Möbius inner function which has a fixed point $\alpha \in D$. Then $J(g) = \partial D$.*

Proof. If $J(g) \neq \partial D$ then the iterates g^n extend analytically to F which includes D and D' . The fixed point α is attracting and $g^n \rightarrow \alpha$ in D as $n \rightarrow \infty$, while the reflection principle shows that $g^n \rightarrow 1/\overline{\alpha}$ in D' . This contradicts the normality of g^n in F .

LEMMA 39. *Suppose that g is an inner function and $\alpha \in \partial D$ is such that for each $z \in D$ the orbit $z_n = g^n(z)$ approaches α in an arbitrarily small Stolz angle symmetric about $[0, \alpha]$. Then g is non-Möbius and $J(g) = \partial D$.*

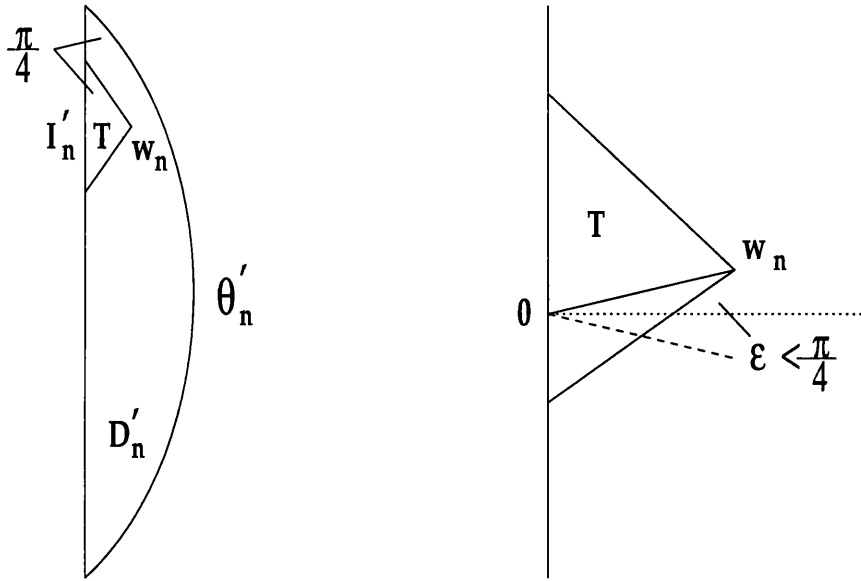

Fig. 5.3: (left) $T \subset D'_n$, (right) $0 \in \partial T$, then $0 \in I'_n$

Proof. It is easy to see that g is not Möbius. Suppose that g is Möbius and inner. By a conformal map we may replace D by $H = \{\text{Im}z > 0\}$, α by ∞ and suppose that all iterates $g^n(z) \rightarrow \infty$ in a direction asymptotic to the vertical. Then $g(\infty) = \infty$ so that $g(z)$ has the form $az + b$, $a > 0$, b real. The behaviour of $g^n(z)$ shows that $a \neq 1$. Thus there is a second real fixed point which we may suppose to be zero. Thus $g^n(z) = a^n z$ which does not have the assumed asymptotic behaviour.

We may suppose that $\alpha = -1$. We assume that $J(g) \neq \partial D$ so that $F_1 = F \cap \partial D$ is non-empty and contains some arc I . Then for each $n \in \mathbb{N}$ the arc $I_n = g^n(I) \subset F_1$ and g is analytic on I_n . Denote by $\omega(z, I)$ the harmonic measure of I at a point z with respect to D . It follows from the maximum principle that $\omega(g(z), g(I)) \geq \omega(z, I)$. By iteration we have $\omega(g^n(z), I_n) \geq \omega(z, I)$ for all $z \in D$ and $n \in \mathbb{N}$.

Now take $z_0 \in D$ so that $\omega(z_0, I) = 3/4$. Then $z_n = g^n(z_0)$ lies in the region D_n in D which is bounded by I_n and a circular arc β_n which passes through the ends of I_n and makes an angle $\pi/4$ with I_n .

Map D to the half plane $H : \text{Re}w > 0$ in such a way that $z = -1$ maps to $w = 0$ and the real axes correspond.

Then D_n maps to a region D'_n bounded by an arc I'_n of ∂H and a circular arc θ'_n , as shown in Figure 5.3, while z_n maps to w_n in D'_n . Clearly D'_n contains the isosceles triangle T cut out of D'_n by drawing lines through w_n of inclination $\pm\pi/4$. Since $\arg(z_n + 1)$ and hence also $\arg w_n \rightarrow 0$ as $n \rightarrow \infty$, we see that for large n the base of the triangle T is a

segment of ∂H which contains $w = 0$. It follows that $-1 \in I_n \subset F(g)$.

In particular, g is analytic at -1 and $g(-1) = -1$. For the orbits to behave as assumed, it is necessary that $g'(-1) = 1$ and this implies that $-1 \in J(g)$, a contradiction to $-1 \in F(g)$. The lemma is proved.

The above proof develops an argument used in [19, proof of Theorem 1].

5.4 Proof of Theorems 5.1.1 and 5.1.2

Let f be an entire function such that U is an unbounded invariant component of $F(f)$. Let Ψ be a Riemann map from D to U and let Θ_∞ be the set defined in the introduction. We shall assume that $\Theta_\infty \neq \emptyset$ and may then suppose that $1 \in \Theta_\infty$.

Then the open subset $E = \partial D \setminus \overline{\Theta}_\infty$ of D is a countable (possibly empty) union of disjoint open intervals I_n . We note that Ψ conjugates f^n , $n \in \mathbf{N}$, to the inner function $g^n = \Psi^{-1} f^n \Psi$. Indeed for almost all θ , as z approaches $e^{i\theta}$ radially, so $\Psi(z)$ approaches a finite $\alpha \in \partial U$, $f^n \Psi(z) \rightarrow f^n(\alpha) \in \partial U$ and by Proposition 2.14 in [65] $g^n(z) = \Psi^{-1} f^n \Psi(z)$ approaches a point of ∂D .

With this notation we have the following lemma.

LEMMA 40. *The inner function g is analytic on E .*

Proof. Suppose that g has a singularity at some point $e^{i\theta_0}$ of $I \subset E$, where I is an interval of E . It follows from the proof of Lemma 34 that there exists $e^{i\theta_1} \in I$ and a path ℓ in D which tends to $e^{i\theta_1}$, such that $g(\ell) = \lambda$ tends to 1 in an Stolz angle. Thus $\Psi(g(\ell)) \rightarrow \infty$ and so $f(\Psi(\ell)) = \Psi(g(\ell)) \rightarrow \infty$ which implies that $\Psi(\ell) \rightarrow \infty$. It follows from Corollary 2.17 in [65] that in fact $\Psi(e^{i\theta_1}) = \infty$ which is impossible since $e^{i\theta_1} \in I \subset E$. The lemma is proved.

LEMMA 41. *$g(E) \subset E$.*

Proof. Let I be an interval of E . If $g(I)$, which is an open subset of ∂D , meets $\overline{\Theta}_\infty$, then $g(I)$ contains points of Θ_∞ , that is, there is $e^{i\theta_1} = g(e^{i\theta_0})$ where $e^{i\theta_0} \in I$ such that $e^{i\theta_1} \in \Theta_\infty$. Thus $\lim_{r \rightarrow 1} \Psi(re^{i\theta_1}) \rightarrow \infty$. Also for the branch of g^{-1} with $g^{-1}(e^{i\theta_1}) = e^{i\theta_0}$ we have that the path $\lambda(r) = g^{-1}(re^{i\theta_1}) \rightarrow e^{i\theta_0}$ in D as $r \rightarrow 1$ (in fact $\lambda(r)$ lies in a Stolz angle at $e^{i\theta_0}$). We have $f(\Psi(\lambda(r))) = \Psi g(\lambda(r)) = \Psi(re^{i\theta_1}) \rightarrow \infty$ as $r \rightarrow 1$. Thus $f \rightarrow \infty$ on $\Psi(\lambda(r))$ so $\Psi(\lambda(r)) \rightarrow \infty$, that is, I contains the points $e^{i\theta_0}$ of Θ_∞ against the assumption ($I \subset E = \partial D \setminus \Theta_\infty$). Thus $g(I) \subset E$.

LEMMA 42. *If g is a non-Möbius inner function, then $J(g) \subset \overline{\Theta}_\infty$.*

Proof. If g is a rational function it has degree greater than one. If the inverse orbit $O^-(1) = \{g^{-n}(1), n \in \mathbb{N}\}$ is finite, then 1 is a super-attracting periodic point which is impossible for an inner function g . Thus Θ_∞ , which contains $O^-(1)$, has infinitely many elements. In $D \cup D' \cup E$ the functions g^n omit all values in Θ_∞ , so that $E \subset F(g)$.

In the case when g is non-rational, all g^n are analytic on E so that again $E \subset F(g)$. This proves the lemma.

Proof of Theorem 5.1.1

Let f , U , Ψ , and Θ_∞ be as above. Further we suppose that ∞ is an accessible boundary point of U along a path $\Gamma(t)$, $0 \leq t < 1$, in U such that $\Gamma(t) \rightarrow \infty$ as $t \rightarrow 1$. We prove first that $\Theta_\infty \neq \emptyset$. It follows from Proposition 2.14 in [65] that $\gamma = \Psi^{-1}(\Gamma)$ is a path in D which approaches ∂D , in fact γ tends to a single point of ∂D (or “lands” in ∂D). Without loss of generality we can assume that γ lands at $z = 1$. It follows that the radial limit at 1, $\Psi(1) = \lim_{r \rightarrow 1} \Psi(r)$, exists and is equal to ∞ . Thus $1 \in \Theta_\infty$ and $\Theta_\infty \neq \emptyset$.

(i) Suppose that U is an attracting basin of the fixed point α . We see that $0 = \Psi^{-1}(\alpha)$ is an attracting fixed point of g in D . Thus g cannot be a Möbius inner function and so by Lemma 38 $J(g) = \partial D$ and $\overline{\Theta}_\infty = \partial D$ by Lemma 42.

(ii) Suppose that U is a Siegel disc. Then the component U contains a fixed point α of the $f(z)$ such that $f'(\alpha) = e^{\pi i \rho}$ where ρ is irrational and f/U is a homeomorphism. We may assume that $\Psi(\alpha) = 0$. It follows that $g = ze^{\pi i \rho}$. Suppose that $E \neq \emptyset$ and let I be an interval of E . It follows from Lemma 41 that $\bigcup_{n=1}^{\infty} g^n(I) \subset E$. Now $\bigcup_{n=1}^{\infty} g^n(I) = \partial D$, but this is not possible because $1 \notin E$.

(iii) Suppose that U is a parabolic basin. Then ∂U contains a point $\alpha \neq \infty$ such that $f^n(z) \rightarrow \alpha$ for $z \in U$ as $n \rightarrow \infty$. We may assume that $\alpha = 0$. The Taylor expansion of $f(z)$ about zero has the form

$$f(z) = z + \sum_{k=m+1}^{\infty} a_k z^k, \quad a_{m+1} \neq 0, \quad (5.2)$$

for some $m \in \mathbb{N}$. We may assume without loss of generality that $a_{m+1} < 0$ and that ∂U

at zero has the tangential directions $\arg z = \pm\pi/m$. Indeed for any $\epsilon > 0$ there exists a positive r such that $\{z : |z| < r, |\arg z| < (\pi/m) - \epsilon\} \subset U \cap D(0, r) \subset \{z : |z| < r, |\arg z| < (\pi/m) + \epsilon\}$. See e.g. [20].

We may assume that Ψ maps $-1 \in \partial D$ to the the prime end of U at zero corresponding to approach along \mathbf{R}_+ . Then (see Lemma 3 in [19]) we have that, as $z \rightarrow 0$ in $|\arg z| < (\pi/m) - \delta$, for any $\delta > 0$, then $\arg(1 + \Psi^{-1}(z)) - (m/2) \arg z \rightarrow 0$. In particular if $z \rightarrow 0$, $\arg z \rightarrow 0$ in U then $\arg(1 + \Psi^{-1}(z)) \rightarrow 0$.

Now for any $z \in U$ the orbit $z_n = f^n(z) \rightarrow 0$ tangent to the real direction. It follows that the orbits of $g = \Psi^{-1}f\Psi$ approach -1 tangent to the real direction. By Lemmas 39 and 42 we have $\bar{\Theta}_\infty \supset J(g) = \partial D$.

Proof of Theorem 5.1.2

We suppose that in this case $f^n \rightarrow \infty$ in the unbounded component U of $F(f)$. It follows from Theorem 2 in [13] that there exists a curve Γ which tends to ∞ in U . Thus ∞ is an accessible boundary point of U along Γ (and we do not have to assume this). Hence $\Theta_\infty \neq \emptyset$. We have assumed further that f is not univalent in U so that $g = \Psi^{-1}f\Psi$ is a non-Möbius inner function and Theorem 5.1.2 follows from Lemmas 37 and 42.

5.5 An example which has a Baker domain

In this section our aim is to give an example of a transcendental entire function $f(z)$ whose domain of normality contains a Baker domain U in which $f(z)$ is conjugate to a rational map $g(z)$ of D .

Consider the function $f(z) = z + e^{-z}$, we shall prove the following theorem.

THEOREM 5.5.1. *There is an unbounded invariant component U which belongs to the Fatou set $F(f)$ and contains the real axis, and for every $z \in U$, $\operatorname{Re} f^n(z) \rightarrow \infty$ as $n \rightarrow \infty$. The Julia set of $f(z)$ contains the lines $y = \pm\pi$.*

Proof. Consider the diagram (5.3) where \mathbf{C}_* is the punctured plane, $\pi = e^{-z}$ and $f(z)$ and $h(z)$ are entire functions such that the diagram commutes.

$$\begin{array}{ccc}
 & f & \\
 \mathbf{C} & \longrightarrow & \mathbf{C} \\
 \pi \downarrow & & \downarrow \pi \\
 & h & \\
 \mathbf{C}_* & \longrightarrow & \mathbf{C}_*
 \end{array} \tag{5.3}$$

It was shown by Bergweiler in [22] that provided $h(z)$ is not linear or constant, so provided $f(z)$ is not of the form $f(z) = kz^n$, $k \neq 0, n \in \mathbf{Z}$, we have $\pi^{-1}(J(h)) = J(f)$.

In particular we shall put $f(z) = z + e^{-z}$ and obtain $h(t) = te^{-t}: \mathbf{C}_* \rightarrow \mathbf{C}_*$, where $t = e^{-z}$, as a projection of $f(z)$ to \mathbf{C}_* . The singularities of h^{-1} are $0, e^{-1}$ and ∞ . Thus $h(t)$ belongs to the class S of entire functions E such that the set of singular points of the inverse function E^{-1} is finite. It follows from Proposition 3 in [35] that all components of $F(h)$ are simply-connected.

The function $h(t)$ has a parabolic fixed point at zero, which is in $J(h)$, whose domain of attraction G belongs to $F(h)$ and contains \mathbf{R}_+ . The boundary of G is tangent to the negative real axis at zero. It follows from Theorem 1 in [35] that $\mathbf{R}_- \subset J(h)$ since $h^n \rightarrow \infty$ on \mathbf{R}_- .

Lifting these results back to $f(z)$ and using Bergweiler’s result we have a component U of $F(f)$ such that $\pi(U) = G$ in which $f^n \rightarrow \infty$ and $\operatorname{Re} f^n \rightarrow \infty$. Thus $\mathbf{R} \subset U$, where ∂U is tangent to the lines $y = \pm\pi$ at $x = +\infty$. The component U is contained in the strip $|y| < \pi$, while the lines $y = \pm\pi$ are in $J(f)$. See Figure 5.4.

The function $f(z)$ has the property $f(z + 2\pi i) = f(z) + 2\pi i$. Thus for every integer n the domain $U_n = U + 2n\pi i$ is an invariant domain which lies within the strip bounded by the lines $y = (2n \pm 1)\pi$, $n \in \mathbf{Z}$, and such lines are in $J(f)$.

THEOREM 5.5.2. *Let $f(z)$ and U be as in Theorem 5.5.1. The map $f(z) : U \rightarrow U$ is conjugate to the rational self-map $g(z) = (3z^2 + 1)/(3 + z^2)$ of D .*

Proof. Since $f : U \rightarrow U$ is a branched cover with U simply-connected and just one branch point of order 2 over $f(0) = 1$ we see that the valency of $f(z)$ in U is 2, by the Riemann -Hurwitz relation.

Let $\Psi : D \rightarrow U$ be the Riemann map such that $\Psi(0) = 0$, Ψ maps $\mathbf{R} \cap D \rightarrow \mathbf{R}$, $\Psi(1) = \infty$, and $\Psi(-1) = -\infty$. The inner function $g : \Psi^{-1}f\Psi$ is a rational map of degree two (since g has no singularities in ∂D and g is two to one by the above result).

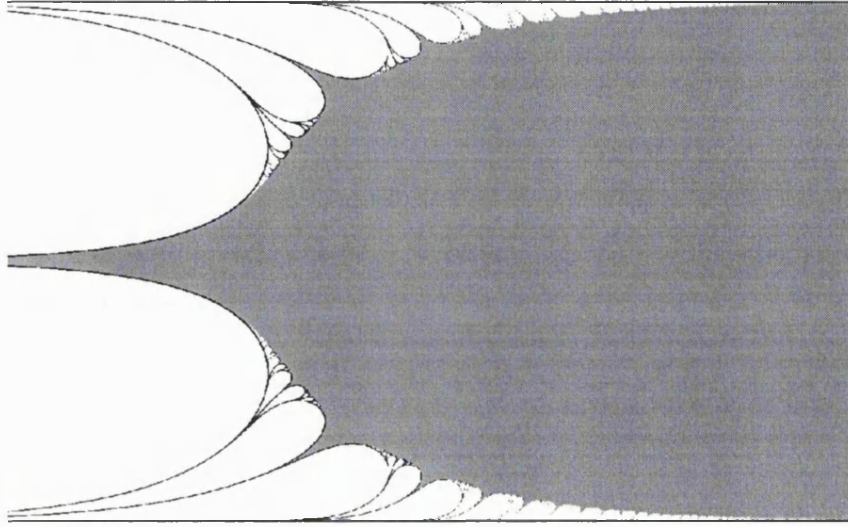

Fig. 5.4: U is contained in the strip $|y| < \pi$ and the lines $y = \pm\pi$ are in $J(f)$. Figure computed by the boundary game method of Weinreich [72]

Now $f(-\infty) = \infty$, $f(\infty) = \infty$. Thus we have that $g(\pm 1) = 1$, g is real on $[-1, 1]$, and g has no fixed point in D since $f(z)$ has no fixed point in U . Thus $g'(1) \leq 1$. Take $\alpha \in (0, 1)$ such that $\Psi(\alpha) = 1$. We see that $g(z) = \alpha$, $z \in U$, if and only if $f(\Psi(z)) = 1$, that is $\Psi(z) = 0$ and hence $z = 0$. Consider the rational map $k : D \rightarrow D$, which is two to one, given by

$$k(z) = \frac{g(z) - \alpha}{1 - \alpha g(z)}. \quad (5.4)$$

The only solution of $k(z) = 0$ is $z = 0$. Since k is real on $(-1, 1)$ and $k(1) = 1$ it follows that $k(z) = z^2$. Therefore (4) can be written as

$$g(z) = \frac{\alpha + z^2}{1 + \alpha z^2}.$$

Next we claim that $g'(1) = 1$ which implies that $\alpha = 1/3$.

Let $d = \text{distance}(x, \partial U)$ for $x \in \mathbf{R}_+$. Since the Poincaré metric $\rho(x)$ on \mathbf{R}_+ lies between $1/4d$ and $1/d$, that is $1/4d \leq \rho(x) \leq 1/d$, we have some constants $\gamma, \beta > 0$ so that $\gamma < \rho(x) < \beta$, $x \geq 0$. The hyperbolic length of $[0, x_n]_U$ is σ_n where $x_n = f^n(x_0)$, $x_0 \in \mathbf{R}$, and $\gamma x_n < \sigma_n < \beta x_n$, for large n .

Now if $v_n = e^{x_n}$, then $v_{n+1} - v_n = e^{x_n} \{e^{x_{n+1} - x_n} - 1\} = \{e^{x_{n+1} - x_n} - 1\} / (x_{n+1} - x_n)$. Since $x_n \rightarrow \infty$ as $n \rightarrow \infty$ we have $x_{n+1} - x_n = e^{-x_n} \rightarrow 0$ and $v_{n+1} - v_n \rightarrow 1$. It follows

that $v_n \sim n$ and $x_n \sim \ln n$ as $n \rightarrow \infty$. If $\Psi(t_n) = x_n$ we have

$$[0, t_n]_D = 2 \ln \frac{1 + t_n}{1 - t_n} = \sigma_n.$$

Thus

$$\frac{1 + t_n}{1 - t_n} = e^{\frac{\sigma_n}{2}}$$

lies between $n^{\gamma'}$, $n^{\beta'}$ or $n^{-\gamma'} < 1 - t_n < 2n^{-\beta'}$ for some positive constants γ' and β' , as $n \rightarrow \infty$.

From the theory of iteration of an analytic function g near a fixed point the above result can hold only if 1 is a parabolic fixed point of g . Thus in fact we have $g'(1) = 1$ as claimed. Therefore $\alpha = 1/3$, so we have

$$g(z) = \frac{\frac{1}{3} + z^2}{1 + \frac{1}{3}z^2} = 1 + (z - 1) - \frac{1}{4}(z - 1)^3 + \dots$$

Since $t_n \rightarrow 1$ in the real direction we can already say that it is a case of two ‘petals’ for g at 1 separated by $J(g) = \partial D$. Also since $g''(1) = 0$ and $g'''(1) \neq 0$, convergence must be $1 - t_n = O(\frac{1}{\sqrt{n}})$.

Together with Lemma 42 the previous results imply the following corollary.

COROLLARY. For U the set Θ_∞ is dense in ∂D .

5.6 Further properties of the preceding example

Before proceeding we require some definitions and results which can be found in [29] and [65].

Let Ω be a simply-connected domain in \mathbf{C} . A simple Jordan arc γ with one end-point on $\partial\Omega$ and all its other points in Ω is called an *end-cut* of Ω ; if γ lies in Ω except for its two end-points γ is called a *cross-cut*.

A point p of $\partial\Omega$ is *accessible* from Ω if p is an end-point of an end-cut in Ω . We say that a sequence $\{\gamma_n\}$ of cross-cuts is a *chain* of Ω if

1. $\overline{\gamma_n} \cap \overline{\gamma_{n+1}} = \emptyset$, $n = 0, 1, 2, \dots$,
2. γ_n separates Ω into two domains, one of which contains γ_{n-1} and the other γ_{n+1} , $n \in \mathbf{C}$, and

3. the diameter of $\gamma_n \rightarrow 0$ as $n \rightarrow \infty$.

It follows from 2 that one of the two sub-domains of Ω determined by γ_n , denoted by V_n , contains all the cross-cuts γ_v , $v > n$, while the other contains all cross-cuts γ_v , $v < n$.

Now let $\{\gamma'_n\}$ be another chain of Ω . We say that $\{\gamma'_n\}$ is *equivalent* to $\{\gamma_n\}$ if for all values of n , the domain V_n contains all but a finite number of cross-cuts γ'_n and the domain V'_n defined by γ'_n contains all but a finite number of cross-cuts γ_n . This defines an equivalence relation between chains. The equivalence classes are called the *prime ends* of Ω . A chain belonging to such a class is said to belong to the *prime end* P . A sequence z_m on Ω converges to P if for a chain $\{\gamma_n\}$ as above, and arbitrary choice of k , z_m belongs to V_k for all but finitely many m . Prime ends describe the correspondence between boundaries of domains under conformal mapping. The *impression* of P is defined by $I(P) = \bigcap \overline{V_n}$ where V_n is the sub-domain of Ω given before. In particular if Ψ is a Riemann map of D to Ω , Ψ induces a one-to-one correspondence between $e^{i\theta} \in \partial D$ and prime ends $P(e^{i\theta})$ of Ω . The set $I(P(e^{i\theta})) = C(\Psi, e^{i\theta})$ which is a non-empty compact connected set and thus either a single point or a continuum.

A point $p \in \mathbf{C}$ is a *principal point* of the prime end P if P can be represented by a null-chain $\{\gamma_n\}$ with $\gamma_n \subset D(p, \epsilon)$ for $\epsilon > 0$, $n > n_0(\epsilon)$; thus $\{\gamma_n\}$ belongs to P . We denote by $\Pi(P)$ the set of all principal points of P . In the above notation $\Pi(P) = C_\rho(\Psi, e^{i\theta})$. Thus the set $\Pi(P) \subset I(P)$ is not empty and is closed. The prime ends fall into the four disjoint classes which were listed in the introduction.

If $E_i \subset \partial D$, $1 \leq i \leq 4$, consists of $e^{i\theta}$ which correspond to the prime ends of Ω of Type i , the results [29, p.182-184] give the following lemma.

LEMMA 43. $E_1 \cup E_2$ has full measure in ∂D ; $E_1 \cup E_3$ is residual in ∂D .

Since the complement of a residual set has category I it follows that E_2 has category I.

We also note the following definition.

DEFINITION. The *left-hand cluster set* $C^+(f, z_0)$ at $z_0 \in \partial D$ consists of all $w \in \widehat{\mathbf{C}}$ for which there are $\{z_n\}$ with $z_n \in D$, $\arg z_n > \arg z_0$, $z_n \rightarrow z_0$, $f(z_n) \rightarrow w$ as $n \rightarrow \infty$. The *right-hand cluster set* $C^-(f, z_0)$ is defined similarly with $\arg z_n < \arg z_0$. It is clear that $C^\pm(f, z_0) \subset C(f, z_0)$.

We say that a prime end is symmetric if $C^+(f, z_0) = C^-(f, z_0) = C(f, z_0)$; otherwise it is asymmetric.

LEMMA 44 [29, Theorem 9.13, p.183]. *The asymmetric prime ends of any simply-connected domain form a set which is at most countable.*

Now we shall prove the following theorem using the above definitions. Let $L^+(L^-)$ be the line $\{x + iy : -\infty < x < \infty, y = \pi(y = -\pi)\}$.

THEOREM 5.6.1. *Let $f(z)$ and U be as in Theorem 5.5.1. The lines L^+, L^- are in ∂U . Indeed, with the conformal map Ψ defined in the proof of Theorem 5.5.2 the prime end Q which corresponds to $1 \in \partial D$ has the impression $L^+ \cup L^- \cup \{\infty\}$. Any end-cut $\ell : \ell(t), 0 \leq t < 1$, of U which approaches ∞ in such a way that $\text{Re} \ell(t) \rightarrow +\infty$ as $t \rightarrow 1$, must converge to Q .*

Proof. As in the proof of Theorem 5.5.1 we put $h(z) = ze^{-z}$ and denote by G the immediate domain of attraction of the parabolic fixed point 0 of h . We recall that $\mathbf{R}_+ \subset G, \mathbf{R}_- \subset J(h)$. The singularities of h^{-1} are 0, which is in $J(h)$, and the algebraic branch point at $1/e$ which corresponds to the critical point at $z = 1$.

Let g denote the branch of h^{-1} whose expansion near $z = 0$ is $g(z) = z + z^2 + \dots$. This may be continued analytically throughout $H = \{z : \text{Im} z > 0\}$ and remains analytic on \mathbf{R} except for a branch point of order two at $1/e$.

Now g is univalent on H and g maps \mathbf{R}_- to \mathbf{R}_- , while it maps \mathbf{R}_+ to a curve Γ_1 , formed by $\beta_1 = (0, 1]$ (the image of $(0, 1/e]$) joined to a curve γ_1 which begins at 1 and enters H in the positive imaginary direction after which it runs to ∞ in H , ($\gamma_1 = g([e^{-1}, \infty))$). As $x \rightarrow \infty$ in $[e^{-1}, \infty)$ then $w = u + iv = g(x)$ satisfies $x = |w|e^{-u+i(\arg w-v)}$. But $0 < \arg w < \pi$ so that $0 < v < \pi$. Moreover $x = |u + iv|e^{-u} \rightarrow \infty$ so that $u \rightarrow -\infty$ while $v = \arg w \rightarrow \pi$ as $x \rightarrow \infty$ (we note for future use by the same calculation that if w and $h(w)$ are both in H , then $\arg h(w) < \arg w$).

Denote the region in H bounded by \mathbf{R}_- and Γ_1 by H_1 , then $g(H) = H_1 \subset H$. Since $H_n = g^n(H) \subset H$ the functions $g^n, n \in \mathbf{N}$, form a normal family in H . Local iteration theory shows that $g^n \rightarrow 0$ in an open set close to zero in the intersection of H with the left-hand plane. Hence $g^n \rightarrow 0$ locally uniformly in H .

Now we see inductively that $\partial H_n = \mathbf{R}_- \cup \Gamma_n$ where $\Gamma_n = \beta_n \cup \gamma_n = g^n(\mathbf{R}_+) \subset G$ and $\beta_n = g(\beta_{n-1}), \gamma_n = g(\gamma_{n-1})$. Moreover, $\beta_n = \beta_{n-1} \cup \alpha_n, n \geq 2$, where β_{n-1} and α_n

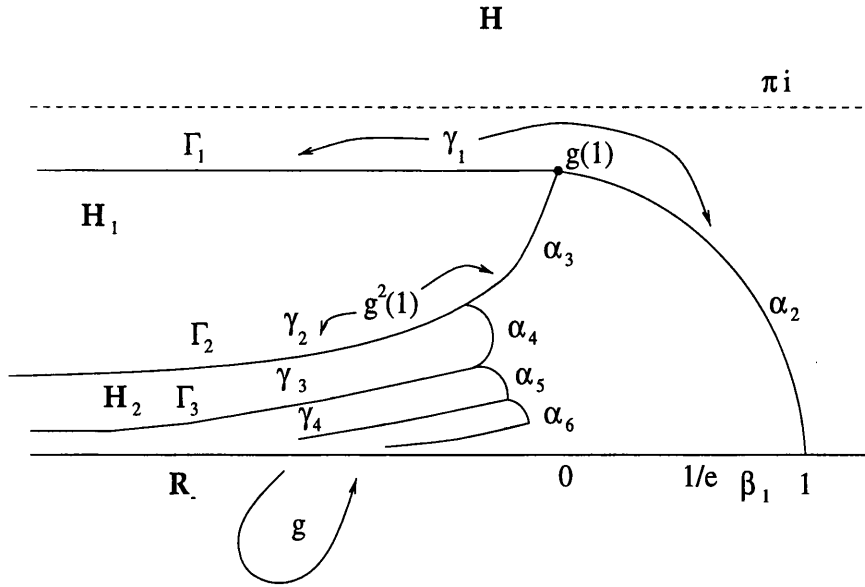

Fig. 5.5: $\bigcup_1^\infty \beta_n = \beta_1 \cup \alpha_2 \cup \alpha_3 \cup \dots$ is a Jordan curve C

are arcs which meet only at their common end point $g^{n-2}(1)$, $g^n \rightarrow 0$ on α_3 , which is a compact subset of H . We see that $\bigcup_1^\infty \beta_n = \beta_1 \cup \alpha_2 \cup \alpha_3 \cup \dots$ is a Jordan curve C (see Figure 5.5) which leaves zero along β_1 and returns to zero along a direction tangent to \mathbf{R}_- . We have $g(C) = C$ and $h(C) = C$ so that h^n is bounded in $I = \text{interior } C$. Hence $I \subseteq F(h)$ and indeed $I \subseteq G$.

Let K_n denote the unbounded domain in H_n cut off by the cross cut $\delta_n = \bigcup_{j=n+2}^\infty \alpha_j$, $n \in \mathbf{N}$, which runs from $g^n(1)$ to zero. The boundary of K_n is \mathbf{R}_- , δ_n and an arc γ'_n of γ_n . We have $g(K_n) = K_{n+1}$, $g(\overline{K}_n) = \overline{K}_{n+1}$. Let $\Delta = \bigcap \overline{K}_n$. Clearly $\overline{\mathbf{R}}_- \subset \Delta$. Also $z \in \Delta$ implies that $h(z) \in \Delta$. Suppose that Δ contains some point z which is not in $\overline{\mathbf{R}}_-$, then we may suppose z chosen to have minimum argument θ , and $0 < \theta$ since Δ does not contain β_1 . But then $h(z) \in H$ and, as observed earlier, $\arg h(z) < \arg z = \theta$ which gives a contradiction. Thus $\Delta = \overline{\mathbf{R}}_-$.

Now by the symmetry of G we see that the curve l_n formed by $\gamma'_n \cup \delta_n$ together with its reflection in \mathbf{R} is in G , except for the point zero.

For a sufficiently small r_n , $n \in \mathbf{N}$, the circle $C(0, r_n)$ meets δ_n but not γ'_n . Let $p_n = r_n e^{i\theta_n}$ be the point with minimum $\theta_n > 0$, $n \in \mathbf{N}$, such that $p_n \in \partial G$. Since $\mathbf{R}_- \subseteq \partial G$ we have $\theta_n \leq \pi$ and indeed $\theta_n < \pi$ because the arcs $C_n : r_n e^{i\theta}, -\theta_n < \theta < \theta_n$, determine a set of cross cuts which define a prime end P of G . If $\theta_n = \pi$ the impression of this prime end is bounded but we know from Theorem A that the impression contains infinity which is a contradiction. Thus $\theta_n < \pi$.

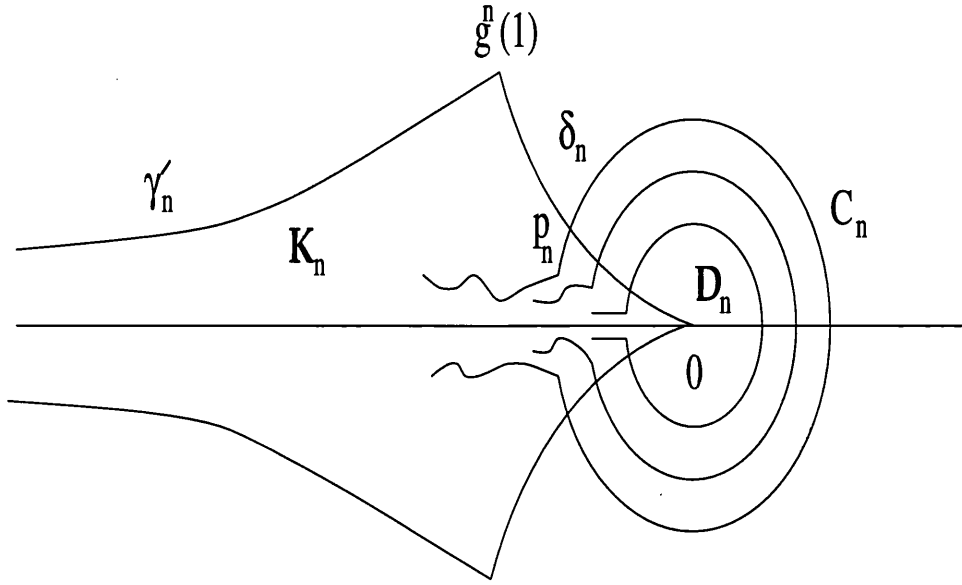
Fig. 5.6: The component D_n

The arc C_n divides G into two components D_n, D'_n . The component which contains $r_n/2$, $n \in \mathbf{N}$, is denoted by D_n (see Figure 5.6). We can see that $D_n \subset (K_n \cup K_n^- \cup D(0, r_n))$ where K_n^- is the reflection of K_n in \mathbf{R} . (We note that the finite points of $\partial K_n \cup \partial K_n^-$ are in $F(h) \cup \{0\}$). Clearly the impression of the prime end P is \mathbf{R}_- , since $\bar{D}_n \subset (\bar{K}_n \cup \bar{K}_n^- \cup \overline{D(0, r_n)})$ we have $I(P) = \bigcap \bar{D}_n$ where $\bigcap \bar{D}_n \subset \bigcap \bar{K}_n = \mathbf{R}_-$. The impression is a continuum which contains zero and infinity therefore $I(P) = \bar{\mathbf{R}}_-$.

Any end cut in G which tends to 0 must remain in D_n after some point. $(0, \epsilon)$ is such an end cut for $\epsilon > 0$. Suppose $\tau(t)$, $t \in (0, 1)$ is an end cut in G which tends to zero as $t \rightarrow 1$. Thus given n , $\tau(t)$ is in $D(0, r_n)$ for $t > t_0$. If $\tau(t)$ is not contained in D_n we may suppose that $\tau \subset D'_n$ and that $\text{Im} \tau(t) > 0$. Thus $\tau(t)$ lies in the part of $D(0, r_n)$ in the upper half-plane which lies below δ_n . We may assume that $\tau(t_0)$ is joined by 0 in D'_n to say $2r_n$ so that the union τ' of $\tau(t)$, $t \geq t_0$ with ρ and with $[0, 2r_n]$ is a Jordan curve Γ in G , except for the point zero. Now p_n lies in the interior of Γ . Since the transcendental function $h : G \rightarrow G$ is 2 to 1 (by conjugacy with f/U) there is some component $G_1 = h^{-1}(G) \neq G$.

For $z_1 \in G_1$ there is some $m \in \mathbf{N}$ such that there is a value of $h^{-m}(z_1)$ so close to p_n that it is inside Γ . The corresponding component $h^{-m}(G_1)$ of $F(h)$ is different to G and is unbounded. Hence $h^{-m}(G_1)$ meets Γ in some open subset of Γ , so in points which are different from zero. But all such points of Γ are in G , this give us a contradiction. Thus τ is in D_n .

We may now lift these results to the Baker domain U for the function $f(t) = t + e^{-t}$ by noting that $z = e^{-t}$ maps U to G so we have that ∂U contains the lines L^+ , L^- . Indeed e^{-t} is univalent in the region between L^+ , L^- , which includes U , so that the prime ends of U and G correspond under the mapping. Thus, corresponding to C_n we have cross cuts $C'_n : x = -\log r_n, -\theta_n < y < \theta_n$ of U which cut off domains D'_n in U such that $e^{-D'_n} = D_n$. The prime end of U defined by (C'_n) is denoted by Q and has impression $L^+ \cup L^- \cup \{\infty\}$. For any $x > 0$, $[x, \infty)$ is an end cut of U which converges to $+\infty$ (and indeed to Q). Any end cut in U which converges to $+\infty$ must remain in D'_n from some point onwards and thus converges to Q .

THEOREM 5.6.2. *If $g^n(e^{i\theta}) = 1$, $n \geq 0$, where g is the quadratic map of Theorem 5.5.2, then $e^{i\theta}$ corresponds to an asymmetric prime end of Type 2 of the domain U of Theorem 5.5.1.*

Since the pre-images of 1 are dense in ∂D we have a natural example of the situation described in Lemma 44.

Proof. We denote by U^+ the part of U above \mathbf{R} and by U^- the part of U below \mathbf{R} . In similar way denote D^+ and D^- such that

$$\Psi : D^+ \rightarrow U^+$$

$$\Psi : D^- \rightarrow U^-.$$

Clearly as $x \rightarrow 1$ in D so $\Psi(x) \rightarrow +\infty$ and $\Psi(1) = Q$ thus Q is in the second type (see the table about prime ends) with principal point ∞ .

Then ∞ is also the angular cluster set of Ψ at 1 [29]. Since Ψ is real on \mathbf{R} the cluster set of Ψ at 1, clearly splits into two 'wings' $L^+ \cup \{\infty\}$ for the left-hand of Q and $L^- \cup \{\infty\}$ for the right-hand wing, corresponding to $z \rightarrow 1$ in D^+ or D^- . Thus Q is an asymmetric prime end of H .

Let z_0 be a predecessor of 1 under the conjugate quadratic map $g : D \rightarrow D$, say $g^m(z_0) = 1$. Then $\Psi(z_0)$ is also an asymmetric prime end, since if the left-hand cluster set of Ψ at z_0 is $C^+(z_0)$ and at 1 is $C^+(1)$ then $\Psi g^m = f^m \Psi$ gives $f^m C^+(z_0) = C^+(1) = L^+ \cup \{\infty\}$ while the right-hand cluster set has $f^m C^-(z_0) = L^- \cup \{\infty\}$.

We return to the study of Θ_∞ for f and U .

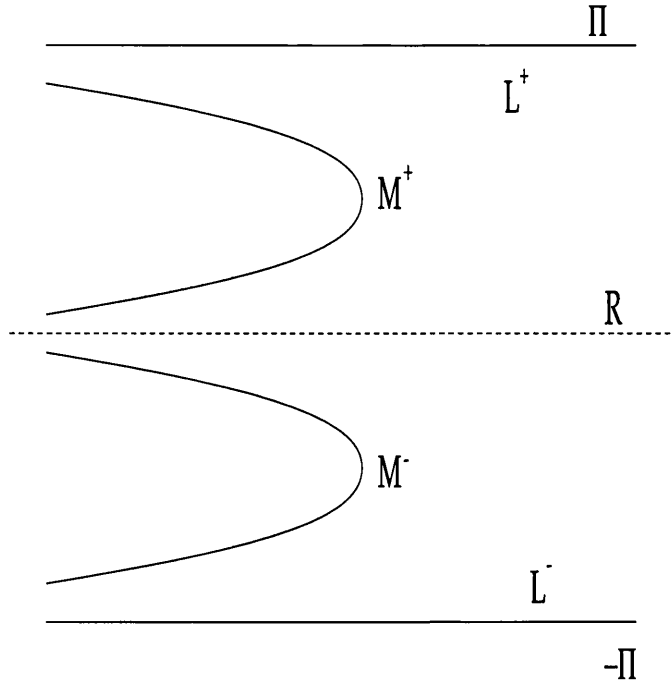

Fig. 5.7: $f^{-1}(L^-) \cap S = L^- \cup M^+$ and $f^{-1}(L^+) \cap S = L^+ \cup M^-$

THEOREM 5.6.3. For $f(z) = e^{-z} + z$ and U as above the set Θ_∞ consists precisely of the countable set of predecessors of 1 under the iterates g^n , $n \geq 0$, with g as in Theorem 5.2.

LEMMA 45. Given $\epsilon > 0$ there exists $A(\epsilon) < 0$ so that $z = x + iy$ in $U \cap \{z : x < A(\epsilon)\}$ we have either $\pi - \epsilon < |y| < \pi$ or $|y| < \epsilon$.

Proof. Let S denote $S = \{z = x + iy, |\text{Im}z| \leq \pi\}$. We know that $f : L^\pm \rightarrow L^\pm$. We claim that the graph of $f^{-1}(L^+) \cap S = L^+ \cup M^-$ is as in Figure 5.7.

In particular, as $z \rightarrow \infty$ on M^- we have $\text{Re}z \rightarrow -\infty$ and $\text{Im}z \rightarrow 0_-$ or $\text{Im}z \rightarrow -\pi_+$. We also have $f^{-1}(L^-) \cap S = L^- \cup M^+$ where M^+ is the reflection of M^- in \mathbf{R} .

To prove the claim we note that in the half plane $H = \{w : \text{Re}w > 0\}$ we have $\text{Re}f'(w) > 0$ so that f is univalent in H . Also $f(H) \subset H - 1$. Thus for large $|\text{Re}z|$ the solutions of $f(w) = z$, $z \in L^+$, $w \in S \setminus L^+$ have $\text{Re}w$ large and negative. Therefore $z = f(w) \sim e^{-w}$ so that $w \sim -\ln z$ and more accurately $e^{-w} = z - w \sim z + \ln z$. Thus $w \sim -\ln(z + \ln z) \sim -\ln z - \ln z/z$ as $z \rightarrow \infty$. Hence $M^- = f^{-1}(L^+) \cap \{z = x + iy, |\text{Im}z| \leq \pi\}$ has one end which goes to ∞ like

$$\begin{aligned} w &\sim -\ln(x + i\pi) - \frac{\ln(x + i\pi)}{x + i\pi} \text{ as } x \rightarrow \infty \\ &= -(\ln x)(1 + o(1)) - \frac{i\pi}{x}(1 + o(1)) \text{ as } x \rightarrow \infty. \end{aligned}$$

For the other end

$$\begin{aligned} w &\sim -\ln(-x + i\pi) - \frac{\ln(-x + i\pi)}{-x + i\pi} \text{ as } x \rightarrow \infty. \\ &= -(\ln x)(1 + o(1)) + i(-\pi + \frac{2\pi}{x})(1 + o(1)) \text{ as } x \rightarrow \infty. \end{aligned}$$

Further M^- , M^+ are symmetric with respect to the real axis. The assertion of Lemma 45 follows from the above.

Proof of Theorem 5.6.3

Let $\sigma : re^{i\alpha}$ be a radial path, $0 < r < 1$ and suppose that the Riemann map $\Psi \rightarrow \infty$ on σ (i.e. $e^{i\alpha} \in \Theta_\infty$). On $g^n(\sigma) : \Psi(g^n(\sigma)) = f^n(\Psi(\sigma)) \rightarrow \infty$ ($e^{-z} + z \rightarrow \infty$ if $z \rightarrow \infty$, $z \in U$). Thus $\Psi(g^n(\sigma)) \rightarrow \infty$ for each fixed n .

If $\operatorname{Re}\Psi(\sigma) \rightarrow +\infty$ then by Theorem 6.1 $\Psi(\sigma) \rightarrow Q$, that is $e^{i\alpha} = 1$.

If $\operatorname{Re}\Psi(\sigma) \rightarrow -\infty$ in $|y| < \epsilon$, then $f(\Psi(\sigma)) \rightarrow +\infty$ so $\Psi(g(\sigma)) = f(\Psi(\sigma)) \rightarrow Q$, so in this case $g(\sigma) \rightarrow 1$, and $g(e^{i\alpha}) = 1$ ($e^{i\alpha} \neq 1$).

If $\Psi(\sigma) \rightarrow -\infty$ in $\pi - \epsilon < |y| < \pi$, then we can assume that $A(\epsilon)$ is chosen so that $x < A(\epsilon)$ implies $\operatorname{Re}(e^{-z} + z) \leq -2\operatorname{Re}z$. Now for all $n \in \mathbf{N}$ $\Psi(g^n(\sigma)) \rightarrow \infty$. If we always have $\operatorname{Re}\Psi(g^n(\sigma)) \rightarrow -\infty$ we must always have this happening in $\pi - \epsilon < |y| < \pi$, so $\operatorname{Re}f^n(\Psi(\sigma)) < -2^n \operatorname{Re}\Psi(\sigma) \rightarrow -\infty$. But for any fixed $z \in U$, $\operatorname{Re}f^n(z) \rightarrow +\infty$. Hence there is a first n so that $\Psi(g^n(\sigma)) \rightarrow -\infty$ in $|y| < \epsilon$ and this implies that $\Psi(g^{n+1}(\sigma)) \rightarrow +\infty$. Then $g^{n+1}(e^{i\alpha}) = 1$, $e^{i\alpha} = g^{-(n+1)}(1)$. Thus the set Θ_∞ consists entirely of the set of predecessors of one under g^n , that is the set corresponding to the asymmetric prime ends which were discussed before. Thus the theorem is proved.

THEOREM 5.6.4. For $f(z) = e^{-z} + z$ and U as above we have $E_1 = \emptyset$, $\Theta_\infty \subset E_2$ while E_3 is residual.

Proof. Since Θ_∞ is dense in ∂D it follows that ∞ belongs to the impression of every prime end of U (i.e. For any θ , $\infty \in C(\Psi, e^{i\theta})$ because there exists $\theta_n \rightarrow \theta$, $e^{i\theta_n} \in \Theta_\infty$ so $\infty \in C_\rho(\Psi, e^{i\theta_n})$). Thus $E_1 \subset \Theta_\infty$. We have seen that Q , and similarly all members of Θ_∞ belong to E_2 . Thus $E_1 = \emptyset$. From Lemma 43 it follows that E_3 is residual.

5.7 Further examples

1. J. Weinreich [72] showed that $j(z) = e^{-z} + z - 1$ has an unbounded invariant component U of $F(j)$ in which j is conjugate to z^2 . Thus U contains a super-attractive fixed point at 0. Our results show that $\overline{\Theta}_\infty = \partial D$. Weinreich showed that Θ_∞ is a countable subset of E_2 while $E_1 = \emptyset$.

2. Our results in Section 5.5 showed that the domain of attraction G of the parabolic fixed point 0 of $h(z) = ze^z$ is unbounded. By projecting the results for f, U in Section 5.6 we find that for h, G we have $\overline{\Theta}_\infty = \partial D$, Θ_∞ countable, $E_1 = \emptyset$.

3. Recalling the example f, U of Sections 5.6, 5.7 as well as 1,2 above we have examples where Θ_∞ is a dense countable subset of ∂D for cases when U is either an attracting domain, a parabolic domain, or a Baker domain (with non-univalent f).

4. In the case of $f(z) = \lambda e^z$, $0 < \lambda < 1/e$, discussed by R.L Devaney and L.R. Goldberg [30] where $F(f)$ is a single unbounded attracting domain, $\partial D = E_1 \cup E_2$ and, as explained in the introduction, $\Theta_\infty = E_1$ is residual, (that is its complement is of first category), and hence Θ_∞ is, in particular, non-countable.

5. Kisaka studies the example $f(z) = e^{-z} + z + 1$, which was one of the functions discussed in Fatou's fundamental paper [1926] on the dynamics of entire functions. Kisaka proved that f has a Baker domain for which $\overline{\Theta}_\infty$ contains a perfect set in ∂D . We shall improve this by showing that $\overline{\Theta}_\infty = \partial D$.

In fact we shall consider a slightly more general class of functions.

Let $\epsilon \geq 0$ be a constant and let k be an entire function such that $|k(z)| \leq \text{Min}(\epsilon, 1/|z|^2)$ outside the strip $S = \{z = x + iy : |y| < \pi, x < 0\}$.

The construction of a non-constant example of such functions is described for example in [43, p.81]. Our example is the function $G(z) = f(z) + \epsilon + k(z)$, where $f(z) = e^{-z} + z + 1$.

We claim that $G(z)$ has a Baker domain U in which the valency of G is infinite and for which $\overline{\Theta}_\infty = \partial D$.

We note that $\epsilon = 0$ gives $G(z) = f(z)$. In this case the result may be obtained more rapidly by lifting the corresponding result for $h(t) = e^{-1}(te^{-t})$ by π^{-1} , where $\pi(z) = e^{-z}$, but the method does not extend to general G .

Since $G(z) = e^{-z} + z + (1 + \epsilon) + k(z)$, we have in $H = \{z : \operatorname{Re} z > 0\}$ that $\operatorname{Re} G(z) \geq \epsilon + \operatorname{Re} k(z) \geq 0$. By the open mapping theorem we have indeed $\operatorname{Re} G(z) > 0$ so that $G : H \rightarrow H$. Thus $H \subset F(G)$ and $z_n = G^n(z) \rightarrow \infty$ in H ‘like n’. Indeed for $z \in H$ we have first that $\operatorname{Re} z_n$ is strictly increasing and so cannot have a finite limit. Then $z_{n+1} - z_n = (1 + \epsilon) + e^{-z_n} + k(z_n) = (1 + \epsilon) + o(1)$. From this it follows that $z_n = O(n)$ and $z_{n+1} - z_n = (1 + \epsilon) + O(1/n^2)$ and hence $z_n = (1 + \epsilon)n + O(1)$. The component U of $F(G)$ which contains H is a Baker domain.

Now G has fixed points where $e^{-z} + 1 + k(z) = 0$. Since $|k(z)| < 1/|z|^2$, Rouché’s theorem shows that for $j \in \mathbf{Z}$ there is a fixed point z_j such that $z_j - (2j + 1)i\pi \rightarrow 0$ as $|j| \rightarrow \infty$. But $H \subset F(G)$ and z_j is not in U . It follows that for each j there is a boundary point z'_j of U such that $z'_j - (2j + 1)i\pi \rightarrow 0$ as $|j| \rightarrow \infty$.

Recall that the Poincaré metric $\rho(z)|dz|$ in U satisfies

$$\frac{1}{4d} \leq \rho(z) \leq \frac{1}{d}, \tag{5.5}$$

where $d = d(z, \partial U)$.

For any z_0 in H we have $z_n = g^n(z_0) = (1 + \epsilon)n + O(1)$ and for any z'_0 in U we have $z'_n = g^n(z'_0)$ such that $[z'_n, z_n] \leq [z'_0, z_0]$, where $[]$ denotes the hyperbolic distance in U . Since there is a constant K such that $d(z, \partial U) < x + K$ for $z = x + iy \in H$ it follows from (5.5) that

$$[z_n, \partial H] > \int_0^{\operatorname{Re} z_n} \frac{dx}{4(x + K)}$$

which tends to ∞ as $n \rightarrow \infty$. This implies that $z'_n \in H$ for all sufficiently large n . But then from our earlier results $z'_n = (1 + \epsilon)n + O(1)$. Thus for any z'_0 , $z'_n \rightarrow \infty$ in H in a horizontal direction.

We form a Riemann map $\Psi : D \rightarrow U$, where $\Psi(1)$ is the prime end P of U which corresponds to the approach to ∞ in U with $\operatorname{Re} z \rightarrow \infty$.

We quote a result of A. Ostrowski [62]: *Suppose that S is a simply-connected domain which satisfies A and B below.*

A. *For every ϕ in $0 < \phi < \pi/2$ there exists $u(\phi)$ such that $S(\phi) = \{w = u + iv : u > u(\phi), |v| \leq \phi\} \subset S$.*

B. *There are sequences $w_n = u_n + iv_n$, $w'_n = u'_n + iv'_n$ in ∂S such that $u_0 < u_1 < \dots < u_n \rightarrow \infty$, $u_{n+1} - u_n \rightarrow 0$, $v_n \rightarrow \pi/2$, and $u'_0 < u'_1 < \dots < u'_n \rightarrow \infty$, $u'_{n+1} - u'_n \rightarrow 0$, $v'_n \rightarrow -\pi/2$.*

Suppose that $z(w)$ maps S conformally onto the strip $\{z = x + iy : |y| < \pi/2\}$ so that $\lim_{u \rightarrow 0} z(u + i0) = \infty$. Then if $0 < \phi < \pi/2$, we have as $\text{Re} w \rightarrow \infty$, $w \in S(\phi)$, $\lim(y(w) - v) = 0$.

By applying this result together with a suitable logarithmic transformation we see that as $z \rightarrow \infty$ in a horizontal direction in H , so $\Psi^{-1}(z) \rightarrow 1$ in D in a direction tangent to the real axis.

We conclude that for the inner functions $g = \Psi^{-1}G\Psi : D \rightarrow D$ the orbit of any $z_0 \in D$ is such that $g^n(z_0) \rightarrow 1$ in a direction tangent to the real axis. By Lemma 10 g is not a Möbius transformation and $J(g) = \partial D$. It follows from Lemma 13 that $\bar{\Theta}_\infty = \partial D$. Our claim is proved.

It is not hard to show G has valency ∞ in U . For $z = x + iy$, $R_v = \mathbf{R} + 2\pi iv$, $v \in \mathbf{Z} - \{0\}$ we have $\text{Re} G(z) \geq e^{-x} + x + (1 + \epsilon) - |k(z)| \geq e^{-x} + x + 1 \geq 2$. Thus $G(R_v) \subset H$ and, by the complete invariance of $F(G)$, R_v belongs to the component U of $F(G)$ which contains H .

Let $T_v = \{z = x + iy : x < 0, (2v - 1)\pi < y < (2v + 1)\pi\}$, $v \neq 0$, and $\Gamma_v = \partial T_v$. Then for z on Γ_v we have $\text{Re} G(z) \leq 2 + 2\epsilon$. We may choose $z_0 = x_0 + 2\pi iv \in R_v \cap T_v$, so that $w_0 = G(z_0) \in K = \{z : \text{Re} z > 2 + 2\epsilon\}$.

Let $z = \gamma(w)$ denote the branch of the inverse of G such that $\gamma(w_0) = z_0$. As we continue g along any path δ which starts at w_0 and remains in K we cannot meet any transcendental singularity of γ , for a such a singularity would correspond to an asymptotic path λ of G which runs to ∞ in T_v (since $G(\lambda) \subset K$) and such that G has a finite limit as $z \rightarrow \infty$ on λ . Clearly no such path exists since $G(z) \rightarrow \infty$ as $\text{Re} z \rightarrow -\infty$, $z \in T_v$.

Thus γ has at most algebraic singularities on δ and the values remain in T_v . By complete invariance of $F(G)$ we have $\gamma(K) \subset U$. Thus $G(U \cap T_v) \supset K$ for each $v \in \mathbf{Z} - \{0\}$ and any value $w \in K$ is taken infinitely often by G in U .

5.8 The results of Devaney and Goldberg on λe^z

Let $C = \{\lambda \in \mathbf{C} : \lambda = te^{-t}, |t| < 1\}$. Then for $\lambda \in C$ the function $f = f_\lambda$ given by $f_\lambda(z) = \lambda e^z$ has an attracting fixed point $z = t$ where $f'(t) = t$. In fact $F(f)$ is a simply-connected completely invariant domain in which $f^n(z) \rightarrow \infty$ as $n \rightarrow \infty$.

Let Ψ denote the Riemann map of $D = D(0, 1)$ onto $F(f)$, which we may normalize

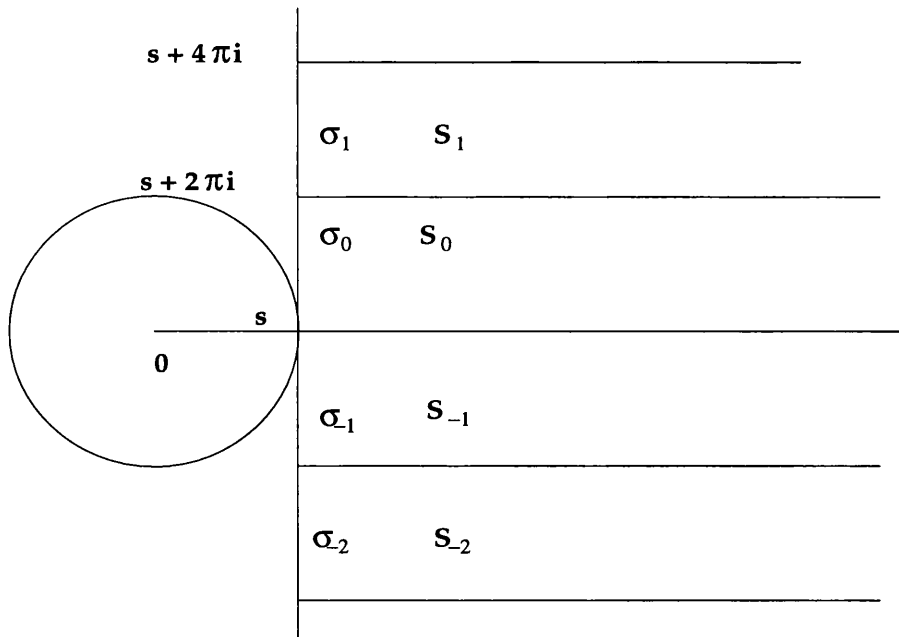

Fig. 5.8: $S_j, j \in \mathbb{Z}$

so that $\Psi(0) = t, \Psi'(0) > 0$. R. L Devaney and R. L Goldberg [30] proved that the radial limit $\Psi(e^{i\theta})$ exists for every $e^{i\theta} \in \partial D$.

This result is important for our present chapter and has also been the starting point of further topological studies and conjectures (see e.g. W. Bula and L.G. Oversteegen [28] and J.C. Mayer [57]). For this reason it seems appropriate to give a proof, slightly different from that of Devaney and Goldberg, of their result.

First note that for any two values $\lambda, \lambda' \in \mathbb{C}$ there is a quasiconformal homeomorphism of the plane which conjugates f_λ to $f_{\lambda'}$ and maps $F(f_\lambda)$ to $F(f_{\lambda'})$. Thus we may assume that λ is real in the range $0 < \lambda < e^{-1}$ corresponding to $0 < t < 1$. From now on λ will have this fixed value.

Then $f = f_\lambda$ has two real fixed points t, s such that $0 < t < 1 < s$. The half-plane $H = \{z : \text{Re } z < s\}$ is invariant under f and therefore belongs to $F(f)$. Clearly $f^n(z)$ does not tend to t for all $z \in [s, \infty)$. Hence $[s, \infty)$ and all its translates by multiples of $(2\pi i)$ belong to $J(f)$. Since $s \rightarrow 1$ as $\lambda \rightarrow 1/e$ we may suppose λ has been chosen so that $s < 2$.

Let $S_j = \{z : \text{Re } z > s, 2\pi j < \text{Im } z < 2\pi(j + 1)\}, j \in \mathbb{Z}$, denote the half-strip, see Figure 5.8.

If we take the branch of $\log z$ whose argument lies between $2\pi j$ and $2\pi(j + 1)$ defined in the plane cut along the positive real axis $[0, \infty)$, then $\ell_j(z) = \log(z/\lambda)$ is a branch of

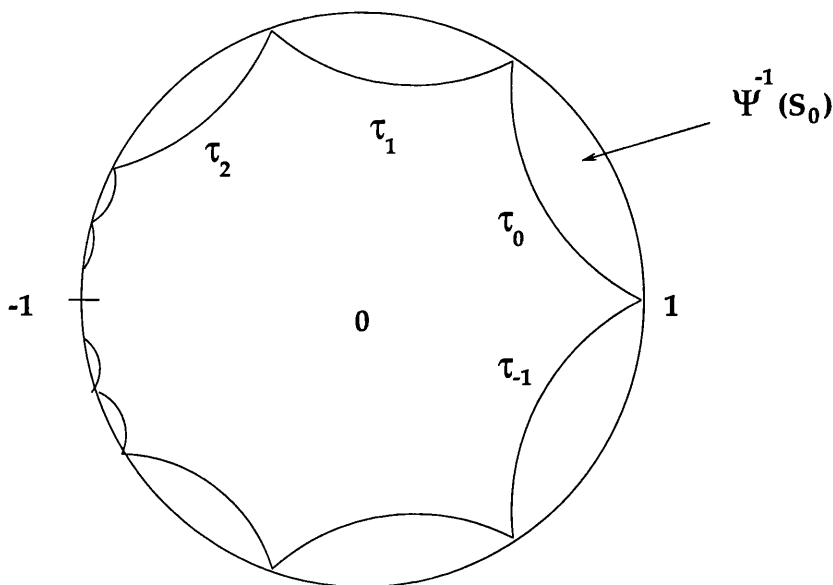

Fig. 5.9: $\Psi^{-1}(S_0)$

the inverse of f which maps the domain $\{z : |z| > s, \arg z \neq 0\}$ onto S_j .

The segments $\sigma_j = \{s + iy : 2\pi j < y < 2\pi(j+1)\}$ form cross cuts of F : $\sigma_j \subset F$ since $f(\sigma_j) \subset F$.

Correspondingly $\tau_j = \Psi^{-1}(\sigma_j)$ form cross cuts of D , disjoint (except for their end points). We note that by the symmetries of F about \mathbf{R} , Ψ is real on $\mathbf{R} \cap D$ and $\Psi(-1) = \infty, \Psi(1) = s$.

We denote the inner function $\Psi^{-1}f\Psi$ by g . Then $g(0) = 0$ and τ_j separates 0 from $\Psi^{-1}(S_j)$ (see Figure 5.9). In $\Psi^{-1}(S_0)$ the function g takes each value at most once, so that g must be analytic at points of ∂D in the boundary of $\Psi^{-1}(S_0)$, except perhaps at the ends of the arc τ_0 . A slight variation of the cross cuts $\sigma_0, \sigma_1, \sigma_{-1}$ allows us to show that g is analytic at the ends of τ_0 also. Similarly for the other τ_j so that g is analytic on $\partial D - \{-1\}$. Since g/D is infinitely many valued (like f/F) we see that g is singular at -1 .

Suppose that for some $k \in \mathbf{N}$, g^k is analytic at $e^{i\theta}$ and that $g^k(e^{i\theta}) = -1$. It follows from $\Psi g^k = f^k \Psi$ that Ψ has the asymptotic value ∞ along some path which tends to $e^{i\theta}$. Consequently the radial limit $\Psi(e^{i\theta}) = \infty$.

Similarly if $g^k(e^{i\theta}) = 1$ for some $k \in \mathbf{N}$ it follows that $\Psi(e^{i\theta})$ exists and satisfies $f^k(\Psi(e^{i\theta})) = s$.

Thus if $e^{i\theta}$ is a preimage under g of $+1$ or -1 the radial limit $\Psi(e^{i\theta})$ exists.

If $e^{i\theta}$ is not a preimage of $+1$ or -1 under g we call it a 'general' $e^{i\theta}$. For each fixed

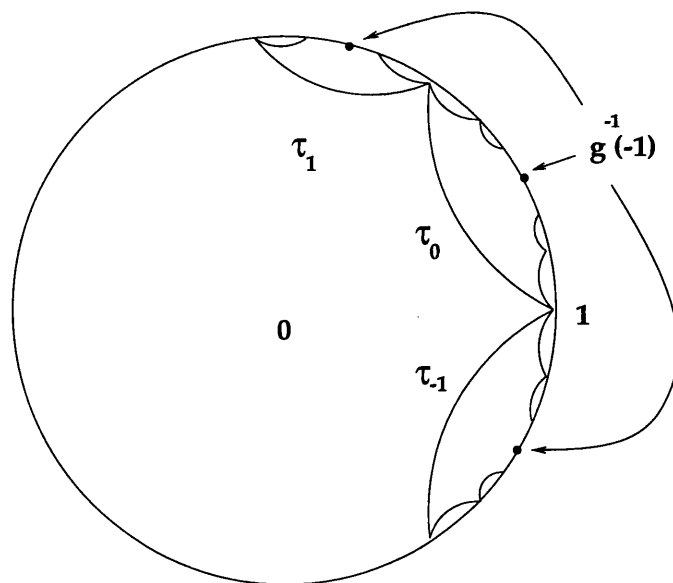

Fig. 5.10: Diagram showing τ_j , $g^{-1}(\tau_j) = \Psi^{-1}f^{-1}(\sigma_j)$

$n \in \mathbf{N} \cup \{0\}$, $e^{i\theta}$ is not the end of any $g^{-n}(\tau_j)$, nor a limit point of such curves, since these are the singular points of g^n , i.e. preimages of -1 (see Figure 5.10). Hence $e^{i\theta}$ is separated from 0 by one of $g^{-n}(\tau_j)$, $j = j(n)$ say, and in fact one of the arcs, say $\tau^{(n)}$ of $g^{-n}(\tau_{j(n)})$. We have $f^n(\Psi(\tau^{(n)})) = \Psi g^n(\tau^{(n)}) = \Psi(\tau_{j(n)}) = \sigma_{j(n)}$.

By Lemma 38 we have $J(g) = \partial D$ so that the predecessors of -1 are dense in ∂D and the distance apart on ∂D of end points of the arcs $\tau^{(n)} \rightarrow 0$ as $n \rightarrow \infty$. Further, each general $e^{i\theta}$ defines a unique sequence $j(n)$, $n \in \mathbf{N} \cup \{0\}$, as above.

We shall now construct a path in f which corresponds to a 'general' $e^{i\theta}$.

For $n = 1, 2, \dots$ let γ_n be the path shown in Figure 5.11, that is $[-s, -s + (2j(n) + 1)i\pi] \cup [-s + (2j(n) + 1)i\pi, -s + (2j(n) + 1)i\pi + s]$. Thus $\gamma_n \in F$. Then $\Gamma_n = \ell_{j(0)} \circ \ell_{j(1)} \circ \dots \circ \ell_{j(n-1)}(\gamma_n)$, lies in F and joins $q_{n-1} = \ell_{j(0)} \circ \ell_{j(1)} \circ \dots \circ \ell_{j(n-1)}(-s)$ with q_n inside $S_{j(0)} \cap F$. It follows that $w_n = \Psi^{-1}(\Gamma_n)$ joins points on $\tau^{(n-1)}$, τ^n in the component K_{n-1} of $D - \tau^{(n-1)}$ which does not contain 0 . If we orient w_n from $\Psi^{-1}(q_{n-1})$ to $\Psi^{-1}(q_n)$, then $\Omega = \bigcup_1^\infty w_n$ is a path in D which lies in K_{n-1} from some point onwards. Since $\Psi(\Omega) = \Gamma$, where $\Gamma = \bigcup_1^\infty \Gamma_n$, our result will be proved if we prove the following theorem.

THEOREM 5.8.1. Γ , parametrized from each q_{n-1} to q_n , has a unique end point, possibly ∞ .

For the end α of Γ is in $J(f)$ since its orbit does not tend to t . Then $\Psi^{-1}(\Gamma)$ lands at a point of ∂D which can only be $e^{i\theta}$.

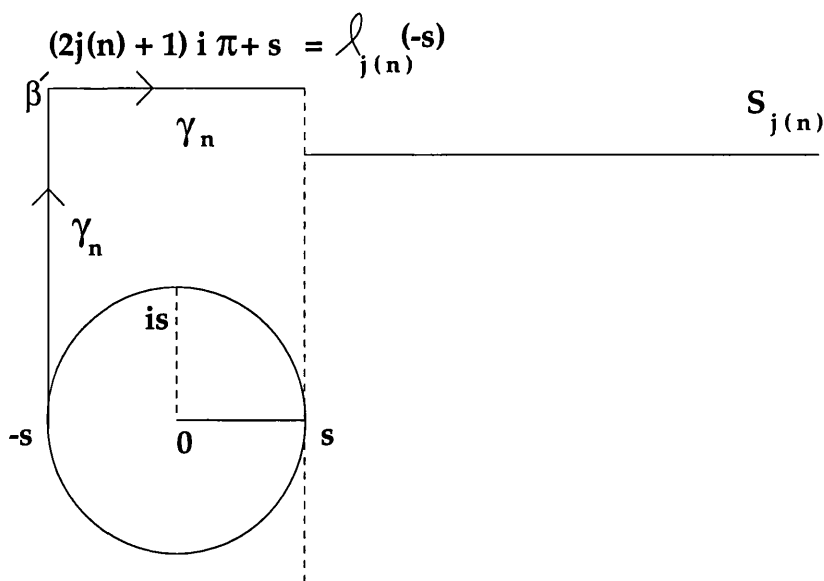

Fig. 5.11: The path γ_n

To prove the theorem above we need two lemmas.

Let K denote a fixed constant such that $K \geq 4$, which implies that $e^K > 1 + K + K^2/2 > 1 + K + 2\pi$.

LEMMA 46. *Suppose that $z_1, z_2 \in S_j, j \in \mathbf{Z}$, and that $\text{Re}z_1 \leq \text{Re}z_2 + K$. Then $|z_1| < e^K|z_2|$. Conversely, if $|z_1| \geq e^K|z_2|$, then $\text{Re}z_1 > \text{Re}z_2 + K$.*

Proof. If $z_k = x_k + iy_k$, then if $x_1 \leq x_2$ we have

$$|z_1| = |x_1 + iy_1| \leq |x_2 + iy_1| = |z_2 + i\delta| \leq |z_2| + 2\pi$$

for some real δ with $|\delta| < 2\pi$.

If $x_1 > x_2$, then we have $x_2 < x_1 < x_2 + K$. Hence for some $0 < \alpha < K$ and some β with $|\beta| < 2\pi$ we have $z_1 = z_2 + \alpha + i\beta$ and $|z_1| \leq |z_2| + K + 2\pi$.

In either case we have, since $|z_2| \geq s > 1$, that

$$|z_1| \leq |z_2| + K + 2\pi \leq |z_2|(1 + K + 2\pi) < e^K|z_2|.$$

LEMMA 47. *Suppose that $\alpha \in \gamma_n$ and β is either a point which lies on γ_n , after α in the orientation we have chosen, or is a point in $S_{j(n)}$. Then $|\alpha| \leq |\beta| + c$, where $c = \pi + 2s$.*

COROLLARY. $|\alpha| < e^K|\beta|$, since $|\alpha| \geq e^K|\beta|$ implies that $3|\beta| + \pi > |\beta| + \pi + 2s = |\beta| + c \geq e^K|\beta|$ which is impossible for $|\beta| > 1$ and $K \geq 4$.

Proof of Lemma 47

- (i) If α, β are in the vertical segment of γ_n , then $|\alpha| < |\beta|$.
- (ii) If α is in the vertical segment of γ_n , whose end point is denoted by β' , and if β is on horizontal segment of γ_n then $|\alpha| \leq |\beta'|$, $|\beta'| \leq |\beta| + 2s$ so that $|\alpha| \leq |\beta| + 2s$.
- (iii) If α, β are both in the horizontal segment of γ_n , then $|\alpha| \leq |\beta| + 2s$.
- (iv) If $\alpha \in \gamma_n, \beta \in S_{j(n)}$, then $|\beta| > |2j(n)|\pi$ and $|\alpha| \leq (|2j(n) + 1|\pi + s \leq |\beta| + \pi + s$.

Proof of Theorem 5.8.1

1. Suppose that there are points z, z' on Γ with z' after z , such that $\operatorname{Re} z > \operatorname{Re} z' + K$. We may suppose that $z \in \Gamma_n$. Then $f^p(z), f^p(z') \in S_{j(p)}, 1 \leq p \leq n-1$. We obtain (inductively) from Lemma 46 that $|f^p(z)| > e^K |f^p(z')|$ and hence $\operatorname{Re} f^p(z) > \operatorname{Re} f^p(z') + K$. Hence we have $|f^n(z)| > e^K |f^n(z')|$, and $f^n(z) \in \gamma_n$, while $f^n(z')$ is either on γ_n after z or in $S_{j(n)}$. It follows from the corollary of Lemma 47 that $|f^n(z)| < e^K |f^n(z')|$ this contradiction shows in fact that for any z' on Γ which comes after z we have $\operatorname{Re} z' \geq \operatorname{Re} z - K$.
2. Recall that Γ lies in $S_{j(0)}$. If there is a sequence of z_n in Γ such that $\operatorname{Re} z_n \rightarrow \infty$, the result of 1 shows that $\Gamma \rightarrow \infty$.

If Γ does not tend to ∞ it follows that $\operatorname{Re} z$ is bounded on Γ and, by 1, $\limsup \operatorname{Re} z - \liminf \operatorname{Re} z \leq K$. Thus for all sufficiently large n , $\bigcup_{j=n}^{\infty} \Gamma_j$, which we denote by $\tilde{\Gamma}_n$, lies in a set of the form $S_{j(0)} \cap \{z : a \leq \operatorname{Re} z \leq a + K + 1\}$.

Fix $m \in \mathbb{N}$. Then for $n > m$ we have $f^m(\tilde{\Gamma}_n)$ is a union of curves $\ell_{j(m)} \circ \dots \circ \ell_{j(n+p-1)}(\gamma_{n+p}), p \geq 0$, defined in the same way as Γ_{n+p} . Hence for all sufficiently large n $f^m(\tilde{\Gamma}_n)$ lies in the set $S_{j(m)} \cap \{z : a' \leq \operatorname{Re} z \leq a' + K + 1\}$, while $f^r(\tilde{\Gamma}_n), r = 0, 1, \dots, m$ all lie in $\{\operatorname{Re} z > s\}$, where $|f'| > s$. Thus $\tilde{\Gamma}_n$ is a (univalent) image of $f^m(\tilde{\Gamma}_n)$ under f^{-m} , and $\operatorname{diam} \tilde{\Gamma}_n \leq (2\pi + K + 1)s^{-m}$, for all sufficiently large n . Since m may be chosen arbitrarily we see that in the present case Γ has a unique finite end point. The proof is complete.

References

- [1] L. Ahlfors, Sur les domaines dans lesquels une fonction méromorphe prend des valeurs appartenant à une région donnée, *Acta Soc. Sci. Fenn. Nova Ser. A. II.* 2 (1933), 1-17.
- [2] L. Ahlfors, *Complex Analysis*, Mc Graw-Hill, 1966.
- [3] D.S. Alexander, *A history of complex dynamics*, Friedr. Vieweg and Sohn Verlagsgesellschaft mbH, Braunschweig/ Wiesbaden, 1994.
- [4] I.N. Baker, Multiply-connected domains of normality in iteration theory, *Math. Zeitschr.* 81 (1963), 206-214.
- [5] I.N. Baker, Repulsive fixpoints of entire functions, *Math. Zeitschr.* 104 (1968), 252-256.
- [6] I.N. Baker, Limit functions and set of non-normality in iteration theory, *Ann. Acad. Sci. Fenn. Ser. A. I. Math.* (1970) 467:1.
- [7] I.N. Baker, Completely invariant domains of entire functions, *Mathematical Essays Dedicated to A. J. MacIntyre*, Ohio University Press, Athens Ohio (1970), 33-35.
- [8] I.N. Baker, The domains of normality of an entire function, *Ann. Acad. Sci. Fenn. Ser. A. I. Math.* 1 (1975), 277-283.
- [9] I.N. Baker, An entire function which has wandering domains, *The Journal of the Australian Math. Soc. (Series A)*. 22 (1976), 173-176.
- [10] I.N. Baker, Wandering domains in the iteration of entire functions, *Proc. London, Math. Soc.* 49 (1984), 563-573.
- [11] I.N. Baker, Some entire functions with multiply-connected wandering domains, *Ergod. Th. and Dynam. Sys.* 5 (1985), 163-169.
- [12] I.N. Baker, Wandering domains for maps of the punctured plane, *Ann. Acad. Sci. Fenn. Ser. AI Math*, 12 (1987), 191-198.

-
- [13] I.N. Baker, Infinite limits in the iteration of entire functions, *Ergod. Th and Dynam. Sys.* 8 (1988), 503-507.
- [14] I.N. Baker, J. Kotus, and Lü Yinian, Iterates of meromorphic functions I, *Ergod. Th and Dynam. Sys.* 11 (1991), 241-248.
- [15] I.N. Baker, J. Kotus, and Lü Yinian, Iterates of meromorphic functions II: Examples of wandering domains, *J. London Math. Soc.* (2) 42 (1990), 267-278.
- [16] I.N. Baker, J. Kotus, and Lü Yinian, Iterates of meromorphic functions III. Preperiodic domains, *Ergod. Th and Dynam. Sys.* 11 (1991), 603-618.
- [17] I.N. Baker L. S. O. Liverpool, Picard sets for entire functions, *Math. Z.*, 126 (1972), 230-238.
- [18] I.N. Baker and P.J. Rippon, Iteration of exponential functions, *Ann. Acad. Sci. Fenn. Ser. A. I. Math.* 9 (1984), 49-77.
- [19] I.N. Baker and J. Weinreich, Boundaries which arise in the dynamics of entire functions, *Revue Roumaine de Mathématiques Pures et Appliquées*, 36 (1991), 7-8, 413-420.
- [20] A.F. Beardon, *Iteration of rational functions*, Graduate texts in Mathematics 132, Springer-Verlag New York, Inc, 1991.
- [21] W. Bergweiler, Iteration of meromorphic functions, *Bull. Amer. Math. Soc. (N.S.)*. 29 (1993), 151-188.
- [22] W. Bergweiler, On the Julia set of analytic self-maps of the punctured plane, *Analysis*. 15 (1995), no 3, 251-256.
- [23] W. Bergweiler, Invariant domains and singularities, *Math. Proc. Camb. Phil. Soc.*, 117 (1995), 525-532.
- [24] W. Bergweiler, M. Haruta, H. Kriete, H. -G. Meier, and N. Terglane, On the limit functions of iterates in wandering domains, *Ann. Acad. Sci. Fenn. Ser. A. I. Math.* 18 (1993), no 2, 369-375.
- [25] P. Bhattacharyya, Iteration of analytic functions, PhD thesis, University of London, (1969).

- [26] H. Bohr, Über einen Satz von Edmund Landau, *Scripta Univ. Hierosolymitararum*. 1 (1923).
- [27] A. Bolsch, Iteration of meromorphic functions with countably many essential singularities, *Vom Fachbereich 03 Mathematik der Technischen Universität Berlin*, (1997).
- [28] W. Bula and L.G. Oversteegen, A characterization of smooth Cantor bouquets, *Proc. A.M.S.*, 108 (1990), 529-534.
- [29] E.F. Collingwood and A.J. Lohwater, *The Theory of Cluster Sets*, Cambridge at the University Press, 1966.
- [30] R.L. Devaney and L.R. Goldberg, Uniformization of attracting basins for exponential maps, *Duke Math J.* 55 (1987), 253-266.
- [31] R.L. Devaney and L. Keen, Dynamics of meromorphic maps with polynomial Schwarzian derivative, *Ann. Sci. Ecole Norm. Sup.*. (4) 22 (1989), 55-81.
- [32] A. Douady and J.H. Hubbard, On the dynamics of polynomial-like mappings, *Ann. Scient. Éc. Norm. Sup*, 4^e série, t. 18 (1985), p. 287 à 343.
- [33] A. E. Eremenko, On the iteration of entire functions, *Dynamical Systems and Ergodic Theory*, *Banach Center Publications*, 23 (1989), 339 -345.
- [34] A.E. Eremenko and M.Yu. Lyubich, Iteration of entire functions, *Dokl. Akad. Nauk SSSR* 279, 1984, *N_o.1*, 25-27 and preprint, Kharkov, (1984) (Russian).
- [35] A.E. Eremenko and M.Yu. Lyubich, Dynamical properties of some classes of entire functions, *Ann. Inst. Fourier, Grenoble*. 42 (1992), 989-1020.
- [36] L. Fang, Complex dynamical systems on C^* (Chinese), *Acta Math. Sinica*. 34 (1991), 611-621.
- [37] L. Fang, Area of Julia sets of holomorphic self-maps, *Acta Math. Sinica (N.S.)*. 9 (1993), 160-165.
- [38] L. Fang, On the iterations of holomorphic self-maps of C^* , *preprint*.
- [39] P. Fatou, Sur les équations fonctionnelles, *Bull. Soc. Math. France*. 47 (1919), 161-271 and 48 (1920), 33-94, 208-314.

- [40] P. Fatou, Sur l'itération des fonctions transcendentes entières, *Acta Math.* 47 (1926), 337-370.
- [41] D. Gaier, *Lectures on complex approximation*, Birkhäuser, Boston, 1985.
- [42] W. Gross, Über die Singularitäten analytischer Funktionen, *Monat. Math. Physik.* 29 (1918), 3-47.
- [43] W.K. Hayman, *Meromorphic functions*, Oxford Mathematical Monographs, Oxford University Press 1964, p.148.
- [44] M. E. Herring, An extension of the Julia-Fatou theory of the iteration, PhD thesis, University of London, (1994).
- [45] M.R. Herman, Are there critical points on the boundaries of singular domains?, *Commun. Math. Phys.* 99 (1985), 593-612.
- [46] M.R. Herman, Sur la conjugaison différentiable des difféomorphismes du cercle à des rotations, *Inst. Hautes Études Sci. Publ. Math.* 49 (1979), 5-233.
- [47] M.R. Herman, *Conjugaison quasi-symétrique des difféomorphismes du cercle à des rotations et applications aux disques singuliers de Siegel I*, Manuscript.
- [48] L. Keen, Dynamics of holomorphic self-maps of C^* , in holomorphic functions and moduli I, edited by D. Drasin, C.J. Earle, F.W. Gehring, I. Kra and A. Marden, Springer, New York, Berlin, Heidelberg 1988, 9-30.
- [49] L. Keen, Topology and growth of special class of holomorphic self-maps of C^* , *Ergod. Th. and Dynam. Sys.* 9 (1989), 321-328.
- [50] M. Kisaka, On the Connectivity of the Julia Sets of Transcendental Entire functions, *Bull. Josai Univ.* Special Issue 1 (1997), 77-87.
- [51] J. Kotus, Iterated holomorphic maps of the punctured plane in dynamical systems, edited by A.B. Kurzhanski and K. Sigmund, Lect. Notes Econ. and Math. Syst. 287, Springer, Berlin, Heidelberg, New York 1987, 10-29.
- [52] J. Kotus, The domains of normality of holomorphic self-maps of C^* , *Ann. Acad. Sci. Fenn. Ser. A I Math.* 15 (1990), 329-340.

-
- [53] O. Lehto, *Univalent functions and Teichmüller spaces*, Springer-Verlag, New York, 1987.
- [54] K. Löwner, Untersuchungen Über schlichte Konforme Abbildungen des Einheitskreises I, *Math. Ann.* 89 (1923), 103-121.
- [55] P.M. Makienko, Iterates of analytic functions of C^* , *Soviet Math. Dokl.* 36 (1988), 418-420; translation from Dokl. Akad. Nauk. SSSR 297 (1987).
- [56] P.M. Makienko, Herman rings in the theory of iterations of endomorphisms of C^* , *Siberian Math. J.* 32 (1991), 431-436; translation from Sibirsk. Math. Zh. 32 (1991), no. 3, 97-103.
- [57] J.C. Mayer, *Complex dynamics and continuum theory* Collection: Continua (Cincinnati, Oh, 1994), 133-157, Lecture notes in Pure and Appl. Math., 170, Dekker, New York, 1995.
- [58] A.N. Mukhamedshin, Mapping the punctured plane with wandering domains, *Siberian Math. J.* 32 (1991), 337-339; translation from Sibirsk. Math. Zh. 32 (1991), no. 2, 184-187.
- [59] C. McMullen, Automorphisms of rational maps, MSRI Preprint 06019-86, (1986) and *Holomorphic functions and moduli I*, MSRI Publications 10, Springer Verlag New York 1988.
- [60] M.H.A. Newman, *Elements of the topology of plane set of points*, Cambridge at the University press 1954.
- [61] K. Noshiro, *Cluster sets*, Springer-Verlag, Berlin 1960.
- [62] A. Ostrowski, Zur Randverzerrung bei konformer Abbildung. *Prace mat. Fizycz.*, 44, (1936), 371-471.
- [63] P. Painlevé, Leçons sur la théorie analytique des équations différentielles professées à Stockholm 1895, Hermann, Paris, 1897.
- [64] G. Pólya, On an integral function of an integral function, *J. London Math. Soc.*, 1 (1926), 12-15.

- [65] Ch. Pommerenke, *Boundary Behaviour of Conformal Maps*, Springer-Verlag New York, 1992.
- [66] Jian-Yong Qiao, The Julia set of the mapping $z \rightarrow z \exp(z + \mu)$, *Chinese Science Bulletin*. 39 no 7 (1994), 529-533.
- [67] H. Rådström, On the iterations of analytic functions, *Math. Scand.* 1 (1953), 85-92.
- [68] F. Riesz and M. Riesz, Über die Randwerte einer analytischen Funktion, *4. Cong. Scand. Math. Stockholm*, (1916), 27-44.
- [69] P.J. Rippon, On the boundaries of certain Siegel discs, *C.R. Acad. Sci. Paris*, t. 319, Série I, (1994), 821-826.
- [70] D. Sullivan, Quasiconformal homeomorphisms and dynamics I, *Ann. of Math.* (2) 122, 1985, 401-418.
- [71] M. Tsuji, Potential theory in modern function theory, Maruzen, Tokyo, 1959.
- [72] J. Weinreich, Boundaries which arise in the iteration of transcendental entire functions. PhD Thesis, University of London (1990).
- [73] G. Whyburn and E. Duda, *Dynamic topology*, Springer-Verlag New York Heidelberg Berlin, 1979.