



# Sizing domestic air-source heat pump systems with thermal storage under varying electrical load shifting strategies

Dashamir Marini\*, Richard. A. Buswell\*, Christina. J. Hopfe

School of Architecture, Building and Civil Engineering, Loughborough University, UK

## HIGHLIGHTS

- Whole system modelling of air source heat pump and thermal energy storage systems.
- Introduces a new 'service' measure to evaluate heating and hot water performance.
- The impact of user demand and system size on delivered service is significant.
- Impact of electricity demand load shifting on service provision is demonstrated.

## ARTICLE INFO

### Keywords:

Hot water  
End use energy demand  
Load shifting  
Thermal energy storage  
Air source heat-pumps (ASHP)

## ABSTRACT

The demand for local heat storage to help manage energy demand in dwellings is likely to increase as the electrification of heat through heat pumps becomes more widespread. Sizing thermal energy storage systems has been an important topic in contemporary literature, but the effect of the electrical load shifting tariff and the service the householder receives in terms of space-heating and hot water delivered, however, has not and this is particularly important when households transition from conventional gas fired to low carbon technologies. This paper takes a whole system modelling approach to understand the impact of user demand patterns and load shifting scenarios on the volume of energy storage required for a heat-pump installation. The work uses monitoring data from several family homes to drive the simulation and finds that the level of service the householder receives is sensitive to their patterns of consumption, thermal energy storage volume and the electricity tariff, with some households being far more sensitive to tariff choice than others. The paper introduces a novel, quantifiable measure of service for space-heating and hot water systems that can be incorporated into thermal energy storage sizing procedures.

## 1. Introduction

Reducing energy consumption and greenhouse gas emissions is one of the key challenges of our generation. The residential sector accounts for 32% of final energy consumption [1] and about 29% of all end-use-related dioxide carbon (CO<sub>2</sub>) emissions [2] in the UK. The Government has committed itself to reduce greenhouse emissions by 80% in 2050 relative to 1990 levels [3]. The reduction of emissions and energy consumption is expected to be achieved by improving insulation levels to reduce the heating demand of buildings [4] alongside schemes to encourage the move towards the adoption of local electricity generation and low-carbon technologies [5].

The need for increasing flexibility in demand is understood [6]: the electrification of heat through the uptake of heat-pump systems could substantially increase the electrical load in low-voltage distribution

systems [7], being more problematic than the introduction of PV [8], creating a challenge for both the capacity [9] and stability of the grid [10].

Flexibility can be delivered in a number of ways which includes using Thermal Energy Storage (TES) to provide frequency regulation or voltage control services to the energy and ancillary service markets [11] and through demand side response schemes [12]. The effectiveness of approaches have been variable: households have been shown to be capable of shifting 10–14% of demand away from peak times [13]; real time pricing of electricity could offer a considerable economic savings [14]; although time-of-use pricing has been shown to perform poorly [15]. Despite this, building owners are likely to be encouraged to participate in the provision of flexible demand and to transition from conventionally to low carbon technologies for the provision of heat.

Typically dynamic modeling tools are used in the evaluation of heat

\* Corresponding authors.

E-mail addresses: [dashamir.marini@gmail.com](mailto:dashamir.marini@gmail.com) (D. Marini), [R.A.Buswell@lboro.ac.uk](mailto:R.A.Buswell@lboro.ac.uk) (R.A. Buswell), [C.J.Hopfe@lboro.ac.uk](mailto:C.J.Hopfe@lboro.ac.uk) (C.J. Hopfe).

## Nomenclature

### Symbols Description [Unit]

<i>ASHP</i>	Air Source Heat Pump [kW]
<i>HWS</i>	Hot Water System [–]
<i>TES</i>	Thermal Energy Storage [l or m <sup>3</sup> ]
<i>B</i>	buffer [l or m <sup>3</sup> ]
<i>T</i>	tank [l or m <sup>3</sup> ]
$\Phi_{sh}$	Space Heating Provided Service [%]
$\Phi_{hw}$	Hot Water Provided Service [%]

$H_{hw}$	hours that heat pump satisfy minimum comfort indoor air temperature [hr]
$H_b$	hours that boiler satisfy minimum comfort indoor air temperature [hr]
$V_{hp}$	volume of hot water provided from heat pump [l or m <sup>3</sup> ]
$V_b$	volume of hot water provided from boiler [l or m <sup>3</sup> ]
<i>NoLSh</i>	No Load Shifting power tariff [£/kWh]
<i>PLSh</i>	Peak Load Shifting power tariff [£/kWh]
$E_7$	Economy seven load shifting power tariff [£/kWh]
$E_{10}$	Economy ten load shifting power tariff [£/kWh]

generation, storage and distribution in buildings [16]. They have been applied to explore the integration of wind power with heat pumps [17] and the flexibility in the scheduling of heat supply in building, where the users comfort was shown to be sensitive to relatively small shifts in demand [18]. The impact of heat pumps and TES for control [19], and TES of heat pump performance [20]. The effect of the capacity of TES has been shown to substantially reduce peak loads [21], as has the sensitivity of the delivery of domestic energy demand to the design of flexible demand strategies [22]. [23] demonstrated the variation in costs and flexibility associated with load shifting.

It has been demonstrated that heat pump systems equipped with TES operating under a low cost electricity tariff and influenced by non-dispatchable renewable energy generation, can achieve greater benefits for building users compared to conventional systems [24], although costs are likely to be higher [25]. Control is also more complex than for conventional systems, but can save up to 30% in running costs if suitable strategies for the integration within smart grid are adopted [26]. This is encouraging for the householder and presents an incentive to undergo the transition, however the performance is not independent of the dynamics of the building, its systems and the demands placed on it. The ability to move heating demand within a defined off-peak heating window diminishes as the load increases for fixed capacity heating systems [27].

Research into lifestyles has highlighted the influence of routines [28] and the sensory environment [29] in family homes. Because of the complexity of social factors each home experiences, these almost always leads to idiosyncratic behaviour where patterns of consumption can vary significantly between family homes that might be considered similar in an demographic sense [30]. These routines utilise the service provided by systems and appliances, which consume water and energy. Thus a routine generates a need for energy that varies in timing and magnitude throughout the day, the week and the year. What has not been reported in the literature is how the idiosyncratic differences between households influence the design of systems with air source heat pumps and TES under peak load shifting strategies, and how these combinations might affect the level of service provided by such a system.

Although gas fired boilers still dominate heating systems in the UK (26 million homes, about 85%) it is expected that about 6.4 million residential heat pumps will be installed across UK by 2030 supported by financial incentives [31]. A heat pump in combination with TES, therefore, could be retrofitted into many existing dwellings [32]. Such an arrangement can enable flexible demand strategies [33], however it is necessary to understand how the system can be used for peak load shifting and how that might affect the size of the storage tank required [34], but to the best knowledge of the authors, there are no empirically based, user centered studies that attempt to evaluate the level of service that a householder might expect to receive from heat-pump/TES space heating and hot water systems.

This paper takes a whole system modelling approach to understand the trade-offs between thermal storage size and peak shifting capabilities with respect to the service the system provides in a number of different households with varying heat demands. It introduces a novel

approach to enable the impact on the service provided by the systems to be quantified, based on the performance of their existing combination-boiler system. These insights can be used in the design of systems to ensure better performance is realised from the users perspective. Although the work uses dwellings in the Midlands in the UK as a case study, the methods developed are widely applicable.

## 2. Methodology

TRNSYS [35] is used to dynamically model the building fabric, heating and control systems. Five models are developed based on real mid-sized family homes that were surveyed for size and construction. In those households, gas, electricity and hot water consumption alongside indoor air and heating system temperatures were measured and 12 months of data over 2013 were used to drive the simulations. Each model, therefore closely represented a specific household where the user preferences and effect of building type are implicitly represented in the data. The data used in this paper is freely available for download [36].

The heat pump models were derived from manufacturers data [37]. Suitable heat pump capacities were selected for the investigated cases from this range resulting in discrete unit capacities between 9 kW and 20 kW. The system configuration used in the simulation was based on the manufacturers recommendations, modified to include TES.

Two metrics were developed to measure the service provided by the space-heating and hot water system and the baseline service was determined using the measurement data from the existing systems, which were gas fired, condensing, combination boilers. The simulation models were calibrated to the measurement data so that the model closely represented the real cases [38]. This baseline service was used to represent the householder experience of their existing system, from which one might anticipate, the recipient might expect to see at least as good, if not better service from a newly installed system [39].

405 building/system simulations were run to determine the service characteristics over a range TES sizes and three peak load shifting strategies. The analysis was then based on this output where the effects of TES sizing options, building type and user preferences and the sensitivity of the service provision to load shifting strategies were observed.

The paper makes use of plotted data to relay the complexity of energy and resource use in the home to illustrate the underlying characteristics that are driving the simulation. The representation of the information presents the service provided in two ways, based on the load shifting procedure chosen and based on the household. This way of presenting the results is novel and is used as the basis for the discussion and conclusions. The details of the household characteristics, models and methods are presented in the following sections.

### 2.1. Characteristics and representation of households

Five households similar in a demographic sense were modelled in order to investigate the variation of effect the idiosyncratic behavior of the householder living with the building and interacting with it's

systems might have on the results. The houses were selected from the LEEDR Home Energy Dataset [36]. Each home was within a four mile radius of a market town in the East Midlands of the UK and was typical in construction, size and layout to those found in rural areas throughout in the UK.

Built between 1940 and 1985 all have undergone some degree of retrofit, mainly boiler modernisation (use of gas fired, condensing combination boilers), loft/cavity wall insulation and double glazing. Table 1 provides the details where: ‘Ins. cavity’ refers to an insulated cavity, i.e. a traditional two leaf brick wall with a cavity that has been filled with insulation post construction; ‘Cond.-combi’ refers to ‘Condensing combination’ boilers; ‘HWS’ refers to the hot water system, i.e. the heat generated for hot water used in showers is either by the boiler or by electrical power (in two homes an additional shower in a second bathroom was fed by a separate cold water supply, heated instantaneously at point of draw off by electrical power). U-values were estimated based on a survey of the construction type and published norms [40]. Note that floor areas and U-values for H09, H10 and H37 are similar, H30 is a little smaller, but has poorer insulation and H43 is a bigger property, at least 20% larger than the others in the sample.

All homes were occupied by families comprising two adults and two children, except H30, that was occupied by one adult and child. Gas and hot water consumption were sampled every second, power, every minute and indoor and outdoor air temperatures, boiler flow temperature were sampled every two minutes. Gas and hot water were aggregated and temperatures were interpolated to one minute to synchronise with the power data. Further details of the measurements can be found in [41].

A dynamic thermal simulation of each home was developed in TRNSYS and was driven using local monitored weather data (see [42] for further information). The average space heating set point temperature of the sample was 20.5 °C similar to the findings of [43] and also [44]. The schedule of the heat demand for each house was determined using the boiler flow temperature measurement to indicate when space heating was active.

Fig. 1 depicts the frequency of heat demand over an entire heating season (1<sup>st</sup> October 2012 to 30<sup>th</sup> April 2013). H09, H30 and H37 show a typical two-schedule profile with periods of manually extended, or boosted heating either side and between these times. The demand for heat in the simulation was driven from the minutely data so that the occupant heat preferences were implicitly captured in the analysis. Each home, therefore, uses detailed, yet different demands for heat over the year and hence the implications for their preferences/needs on service level and storage capacity are treated in the analysis.

**Table 1**

An overview of the characteristics of five homes modelled in the analysis. Note that H09, H10 and H37 are similar in terms of size and wall U-value and all house four people. H30 is a little smaller, but with poorer thermal insulation and H43 is >20% larger than the other properties.

Characteristics	Homes				
	H9	H10	H30	H37	H43
House Type	Detached	Detached	Detached	Detached	Detached
Construction Year	1970	1985	1960	1978	1940
Volume (m <sup>3</sup> )	288	355	220	390	484
Floor Area (m <sup>2</sup> )	129	148	88	140	190
Wall Type	Ins. cavity <sup>a</sup>	Ins. cavity <sup>a</sup>	Solid brick	Ins. cavity <sup>a</sup>	Ins. cavity <sup>a</sup>
Wall U-values (W/m <sup>2</sup> K)	0.45	0.4	0.8	0.4	0.45
Glazing Type	Double	Double	Double	Double	Double
Windows U-values (W/m <sup>2</sup> K)	2.1	2.1	1.8	1.8	1.8
Boiler type	Cond.-combi <sup>b</sup>	Cond.-combi <sup>b</sup>	Cond.-combi <sup>b</sup>	Cond.-combi <sup>b</sup>	Cond.-combi <sup>b</sup>
Shower Type	HWS <sup>c</sup> /Power	HWS <sup>c</sup>	HWS <sup>c</sup>	HWS <sup>c</sup>	HWS <sup>c</sup> /Power
Occupancy (number and type <sup>d</sup> )	4 (2A and 2C)	4 (2A and 2C)	2(1A and 1C)	4 (2A and 2C)	4 (2A and 2C)

<sup>a</sup> Insulated cavity;

<sup>b</sup> Condensing combination boilers;

<sup>c</sup> Hot water system;

<sup>d</sup> Adult or Child

Fig. 2 depicts the hot-water draw-off profiles and the average hot water demand per home. On the top plot the average hot water demand profiles for each home are presented over the year and normalized over a 24 h schedule. The top plot presents the 24 h mean profiles for each house in the sample and the bottom plot shows the average daily hot water consumption per home. It can be seen that the latter differs significantly with H37 consuming the lowest with 105 L/day and H30 consuming the highest with 237 L/day on average.

## 2.2. Quantifying ‘service’

Figs. 1 and 2 demonstrate the variation in the demand for space heating and hot water services between households: they are quite varied in terms of timing, water volume and heating demand. These figures underpin the pattern of the demand for heat that householders have come to expect from the system that they are familiar with. The heat service provided by the new ASHP and TES system can therefore be compared to the service provided by the existing system as a baseline against which any benefits or short comings of the new system can be evaluated.

The notion of ‘service’ can be described by a ratio of the delivered demand over a specified minimum level. In this case, we use the service delivered by the new system over the service delivered by the current system, quantified using temperature measurements. The space heating service is estimated based on the indoor air temperature as it provides a more direct relationship with the experience of the occupants. A threshold temperature of 18 °C is selected [45], the hours above which are judged to be providing a minimum or greater level of service when the heating system is in operation. Hence the number of serviced hours can be established. The estimated temperatures from the simulation of the new system are compared to the measured temperature data from the existing system. The level of service (dimensionless),  $\phi_{sh}$ , is given by,

$$\phi_{sh} = \left( \frac{\sum_{i=1}^n H_{hp}}{\sum_{i=1}^n H_b} \right) \cdot 100, \quad (1)$$

where  $H_{hp}$  (hours) is the total number of hours equal or above the threshold from the simulation of the heat-pump system and  $H_b$  (hours) are the number of hours the existing boiler system delivers at least the minimum indoor air temperature. A value of 100% indicates that the new system is providing an identical level of service to the old system.

The service of the hot water is evaluated in a similar way, using the

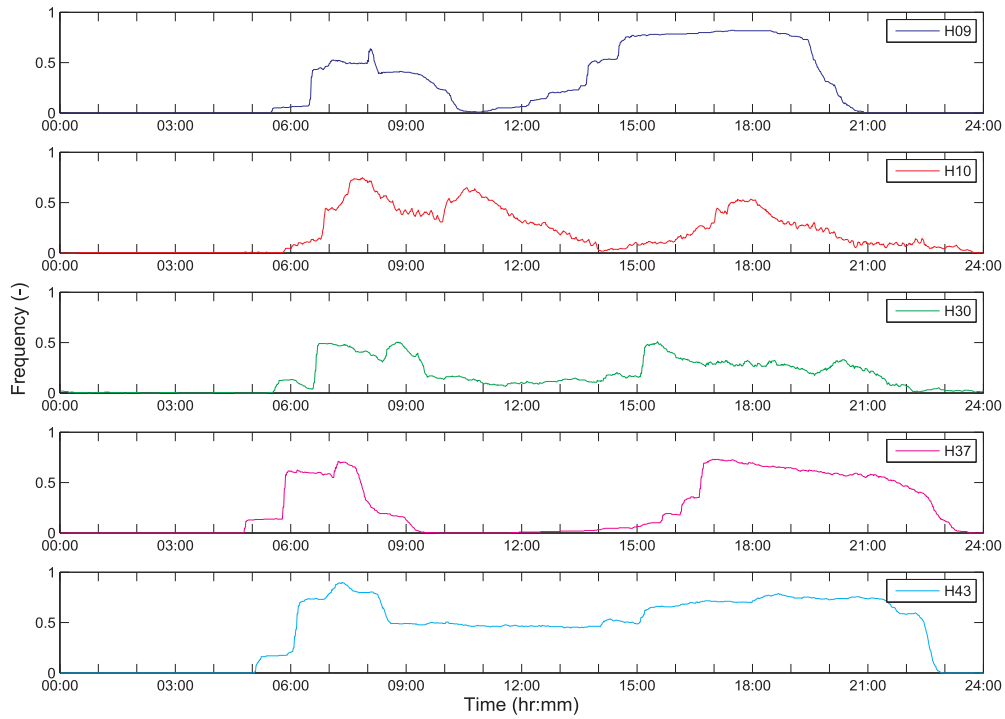

Fig. 1. The daily heating schedules for each household were obtained over a 12 month period of monitoring and represented as a binary indicator (1/0, on/off) these were then aggregated over a 24 h period to provide the frequency traces plotted.

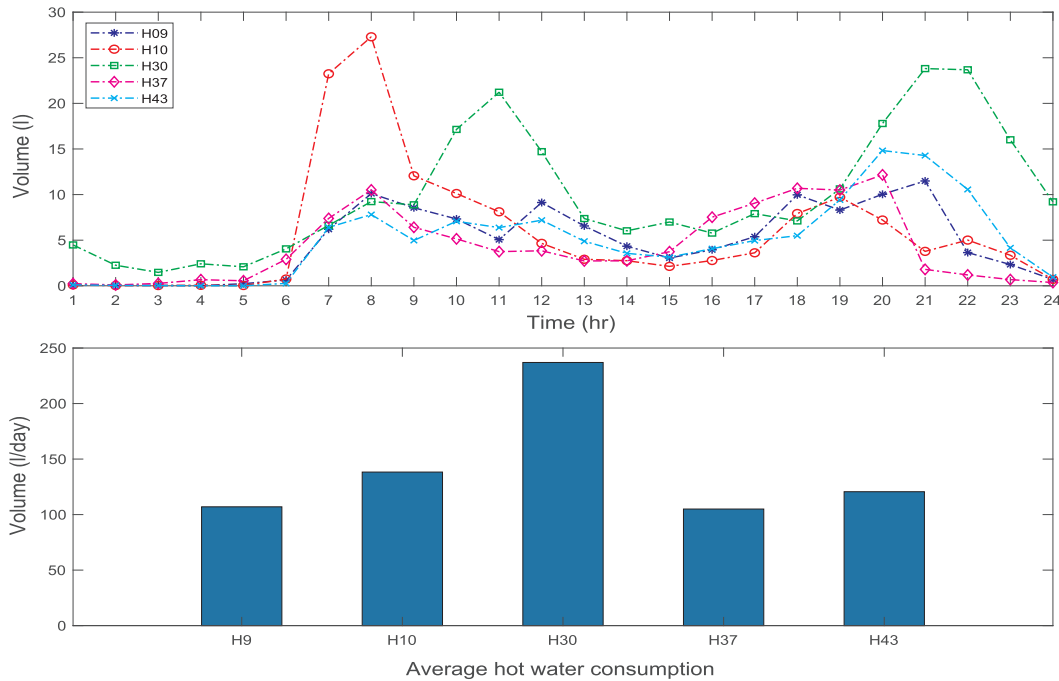

Fig. 2. Average hourly hot water demand profiles derived from 12 months of monitoring data. The top plot depicts the 24 h mean profiles for each house in the sample and the bottom plot provides the average daily hot water consumption per household.

ratio of the volume of hot water supplied above a threshold temperature. A value of 45 °C measured at the supply from the tank was used to compare with the supply temperature of the combination boiler [42]. This removes the effect of the pipe network which will vary between the homes. The hot water service  $\phi_{hw}$  (dimensionless) is given by,

$$\phi_{hw} = \left( \frac{\sum_{i=1}^n V_{hp}}{\sum_{i=1}^n V_b} \right) \cdot 100, \tag{2}$$

where,  $V_{hp}$  is the volume of hot water drawn at or above the threshold temperature based on the simulation of the ASHP and TES system,  $V_b$  is the total volume based on the measurements from the existing boiler

system.

### 2.3. Modelling the heat pump system operation and control

The ASHP system modelled in this work is based on the Mitsubishi PUHZ models where the performance data used in the simulation can be found in [37]. For example, the 14 kW heat pump modelled is based on the PUHZ-HW140V/YHA2(-BS) on page 60. The capacity and performance of the heat pump were modelled as a function of the outdoor air temperature and the inlet (return) water temperature based on the specified catalogue data.

The effective storage capacity especially in the context of demand response is highly dependent on the degree of stratification inside the tank [46]. The modelled buffer and storage tanks were divided equally into twenty-five equal horizontal volume stratification layers. The heat is transferred from the heat pump to the buffer and tank through heat exchangers. Table 2 shows the design input parameters considered for the components of the system.

In the modelled system, there are two water flow closed loops: one loop is between the heat pump, the HWS cylinder and the TES and the other loop is between the TES and the radiators, depicted in Fig. 3. The first closed loop is between the heat pump (Type941), the HWS cylinder (Type534-coiled) and the TES (Type534).

The water is circulated by the pump (Type3d-1) and is controlled by two thermostats (Type1502-1 and Type1502-2) and the controller component 'Controller-HP'. The heat pump unit is connected to the HWS cylinder and the TES with their respective heat exchangers. It is controlled to charge firstly the HWS cylinder and then the TES. The controller component receives a control signal from the thermostat to determine the position of the diverting valve (Type647-2) and the operation of the circulation pump (Type3d-1). The temperatures of the HWS cylinder and the TES is maintained to the respective set-point temperature,  $\pm 0.5$  °C.

The second closed loop is between the TES (Type534) and the radiators (Type1231) where the water is circulated by a pump (Type3d-2) from the TES to the thermal zones to provide space heating. The circulation pump will switch-on and circulate water into the loop when it receives a signal from the controller component (Controller-HS). The controller component itself receives signals from two components: the thermostat (Type108-Thermostat) in one of the zones in the building, usually the living room; and the data reader (Type9a-HScd), which models the programmable controller that defines the schedule of the space heating (Fig. 1).

Diverting valves (Type647/649-2) are used to control the set-point temperature of the water supplied from the TES to the radiators by mixing proportions of supply with return water flow rates. Each of the radiators (Type1231) has a defined capacity and a water mass flow rate. Other components in the system include Type(9a) that reads the domestic hot water demand profile (Fig. 2) drawn from the HWS cylinder. The HWS is delivered to the faucet through the pipe network (Type709).

Model Type9a-4 is used to set the HWS cylinder and the cold water inlet temperature based on measurements. Type14h defines the override operation schedule to control the switching of the ASHP unit based on load shifting patterns. Type15 defines the weather data variables, based on local measurements and used to calculate the building's heat demand and the ASHP performance. Component settings, azimuth angles and radiation are used from the building Type56 component for thermal load estimations. On-line plotters and Type65a are used to monitor the simulation and to produce plotted data.

### 2.4. Load shifting

There are many approaches to a price-based control of demand and it has been suggested that its management requires more sophisticated load management strategies than a simple tariff-based approach [47].

Our approach here has been to select four recognised load-shifting strategies that, if adhered to, place different constraints on the charging of the HWS cylinder and the TES systems. These four approaches are outlined in Table 3 and relate to: 'no load shifting' (NoLSh), i.e. a business as usual case; 'Peak load shifting' (PLSh), where charging is restricted to periods either side of the evening peak demand hours; 'Economy 10' (E10), which restricts morning peak, evening peak and night time charging; and 'Economy 7' (E7), which just allows night time charging. Each are modelled in this study and used to test the sensitivity of the service delivered to the TES and the HWS cylinder capacity to charging strategy.

### 2.5. Sizing the heat pumps

Selecting the appropriate size of heat pump and storage capacity is not a straightforward task, even more complicated when considering electrical demand load shifting strategies. It is influenced by demand, set-points, outdoor temperature, system configuration and control and the effectiveness of the heat transfer from heat pump to storage and from storage to building. Electrical load shifting strategies influence the recharge time for storage.

In this study we based our sizing methodology on the approach presented in the CIBSE article [48], using the TRNSYS model and data from the coldest week monitored during then 12 months. For each test case combination (house, load shifting strategy and TES capacity) the heat pump capacity was adjusted in the model to maintain the design set-points in the building as closely as possible. The TES and DHW storage capacities were based on manufactures data [49]. Table 4 provides the results of this sizing procedure. Note that for H09, H10 and H37 up to DHW 350/ TES 800, the heat pump capacities are the same and hence the results show the impact of the user profiles on the service delivered by identical systems. The largest heat pump in the range struggled to satisfy the demand in H43.

## 3. Results

The service provided by the existing space heating and hot water system are presented in Figs. 4 and 5. The former plot uses the measured indoor air temperatures and illustrates the percentage of hours at a given average temperature during the heating season. Of note is the variation in the mean conditions between the households (shown as the interpolated lines) which indicate a variation in the demand for heat, combined with the variations for heat loss from the building. This is both due to the construction type and the preferences of occupants, particularly around ventilation practices [50]. The 'minimum service

**Table 2**

An overview of the design input parameters for the key components in the simulated systems. The ranges cover those used across the five households.

Design Parameter	Unit	Range	Increment
Heat Pump capacity	kW	12–20	2
Circulation pump capacities <sup>a</sup>	W	20–120	10
Circ. pump flow rates <sup>b</sup>	kg/s	0.4–0.7	0.05
Radiator capacities	kW	0.3 – 2.5	0.2
TES capacity	l	300–2000	100
TES height	m	1–2	0.02
HWS cylinder capacity	l	100–500	50
HWS cylinder height	m	0.9–1.5	0.1
Insulation thickness	mm	40	–
Heat loss coefficient	W/m <sup>2</sup> K	0.77/0.85	–
TES temp. set-point	°C	60	–
HWS temp. set-point	°C	55	–
Thermostats dead band	°C	2	–
Heating temp. set-point	°C	20.5	–

<sup>a</sup> Circulation pump capacities

<sup>b</sup> Circulation pump flow rates

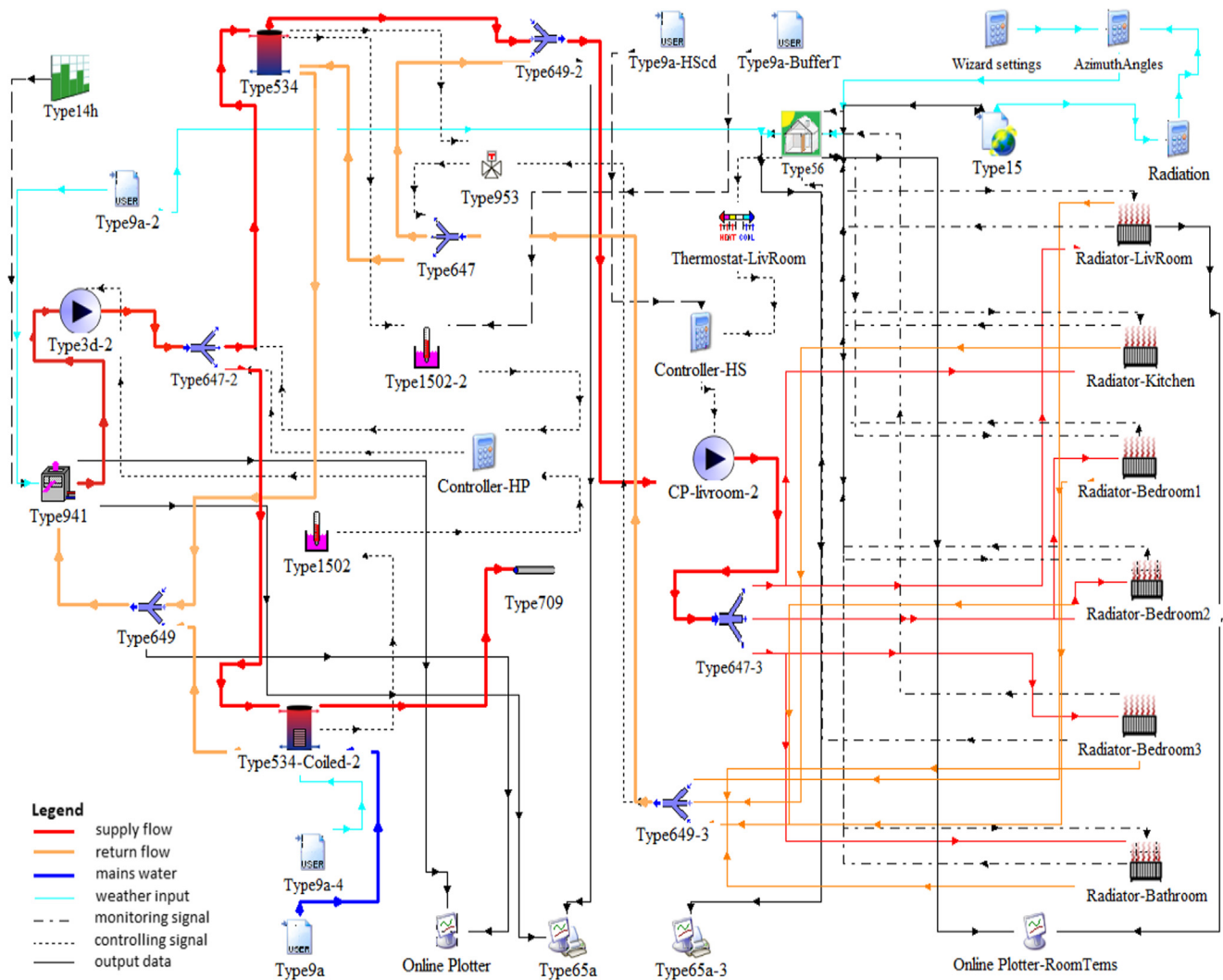

Fig. 3. A schematic of the TYNYSYS heat pump system model with TES and HWS cylinder for shifting space heating and domestic hot water demand loads respectively.

Table 3

Load shifting methods and time periods that were used to constrain the thermal store recharging schedule.

Load	Time	Heat Pump
Shifting	Periods	Operation
NoLSh <sup>a</sup>	00:00–24:00	ON
	00:00–16:00	ON
PLSh <sup>b</sup>	16:00–20:00	OFF
	20:00–24:00	ON
E10	00:00–05:00	ON
	05:00–13:00	OFF
	13:00–16:00	ON
	16:00–20:00	OFF
	20:00–22:00	ON
E7	22:00–24:00	OFF
	23:00–06:00	ON
	06:00–23:00	OFF

<sup>a</sup> NoLSh-No Load Shifting;  
<sup>b</sup> PLSh -Peak Load Shifting

level' threshold of 18 °C might suggest that H09 and H30 have poorer heating provision than H10 and H37, although this is ultimately determined by the occupants preference. Those households with lower service are more likely to enjoy a benefit from an improved service

delivered by the new system.

Fig. 5 is based on measurements at the outlet of the combination boilers and show the percentage of hot water volumes that have been supplied at a certain temperature out of the total hot water use for each home. While the highest percentages of the volumes (i.e. 25%) are drawn for temperatures between 45 and 51 °C, considerable draw-offs occur below the 45 °C minimum service threshold. Note that because of the higher storage temperatures in TES systems, moving from a combination boiler is likely to increase the service provided to all homes studied here.

Fig. 6 illustrates the effects of the peak load shifting strategies and the TES capacity on the average indoor air temperatures maintained in H37. The temperatures throughout 2013 are plotted for periods when the space heating system is active. The measured data (powered by the gas boiler) are in red in each plot. The top, middle and bottom plots represent the peak-load shifting (PLSh) strategy, Economy 10 (E10) and Economy 7 (E7) respectively. Different capacities of the TES are plotted on each and demonstrates that peak-load shifting strategy requires the smallest tank to achieve the space temperatures, because a greater number of hours in the day are available for charging. In addition, the seasonal load places greater demands on the energy stored in the TES making it harder to maintain conditions in the cooler periods.

For the same household (H37), Fig. 7 presents the indoor air temperature distribution in percentage of hours when the heating system is active, for a range of TES capacities, for the same three load shifting

**Table 4**

The outcome of the heat pump sizing exercise undertaken for each of the storage capacity options used in the study. Note that for H09, H10 and H37, for the thermal stores up to and including 800 L, the systems are identical and hence variation in the result is only due to the user preferences and how these interact with the thermal characteristics of the building fabric.

T(1)	B(1)	Heat Pumps Selected Capacities (kW)																			
		H9				H10				H30				H37				H43			
		NoLSH	PLSh	E10	E7	NoLSH	PLSh	E10	E7	NoLSH	PLSh	E10	E7	NoLSH	PLSh	E10	E7	NoLSH	PLSh	E10	E7
150	-	14	-	-	-	14	-	-	-	12	-	-	-	14	-	-	-	16	-	-	-
100	300	-	14	14	14	-	14	14	14	-	12	14	14	-	14	14	14	-	16	16	20
150	400	-	14	14	14	-	14	14	14	-	12	14	14	-	14	14	14	-	16	16	20
200	500	-	14	14	14	-	14	14	14	-	12	14	14	-	14	14	14	-	16	20	20
250	600	-	14	14	14	-	14	14	14	-	14	14	14	-	14	14	14	-	16	20	20
300	700	-	14	14	14	-	14	14	14	-	14	14	14	-	14	14	14	-	20	20	20
350	800	-	14	14	14	-	14	14	14	-	14	14	14	-	14	14	14	-	20	20	20
400	900	-	14	14	14	-	14	14	16	-	14	14	16	-	14	14	14	-	20	20	20
450	1000	-	14	14	14	-	16	16	16	-	14	14	16	-	14	14	14	-	20	20	20
500	1100	-	14	14	16	-	16	16	16	-	14	16	16	-	14	14	16	-	20	20	20
500	1200	-	14	16	16	-	16	16	16	-	14	16	16	-	14	14	16	-	20	20	20
500	1300	-	16	16	16	-	16	16	16	-	14	16	16	-	14	14	16	-	20	20	20
500	1400	-	16	16	16	-	16	16	20	-	14	16	16	-	14	16	16	-	20	20	20
500	1500	-	16	16	16	-	16	20	20	-	16	16	20	-	16	16	16	-	20	20	20
500	1600	-	16	16	20	-	20	20	20	-	16	16	20	-	16	16	16	-	20	20	20
500	1700	-	16	20	20	-	20	20	20	-	16	20	20	-	16	16	20	-	20	20	20
500	1800	-	16	20	20	-	20	20	20	-	16	20	20	-	16	16	20	-	20	20	20
500	1900	-	16	20	20	-	20	20	20	-	16	20	20	-	16	20	20	-	20	20	20
500	2000	-	16	20	20	-	20	20	20	-	16	20	20	-	16	20	20	-	20	20	20

cases. The sensitivity of the household to both the TES capacity and how this relates to the load shifting strategy can be seen. The plot readily identifies E7 as poor tariff structure where this house will struggle to maintain 21 °C throughout the heating season.

Fig. 8 is similar to Fig. 7 and depicts the case for the HWS cylinder capacity, under those same conditions. Here the percentages of hot water volume supplied at a given temperature for the volume of the TES and the load shifting strategy are plotted. The red line represents the measured supply from the combination boiler, and the peak between 45

°C and 50 °C is generated as this is the the region of the hot water delivery set-point temperature on the condensing boiler unit that controls the instantaneous supply.

The characteristics are slightly different to the space heating in that there are two temperature peaks, more evident in the E7 tariff, which is due to the intensity of draw-off focused around morning and early evenings as illustrated in Fig. 2. The majority of the water is supplied at a higher temperature due to the set-point temperature on the TES device.

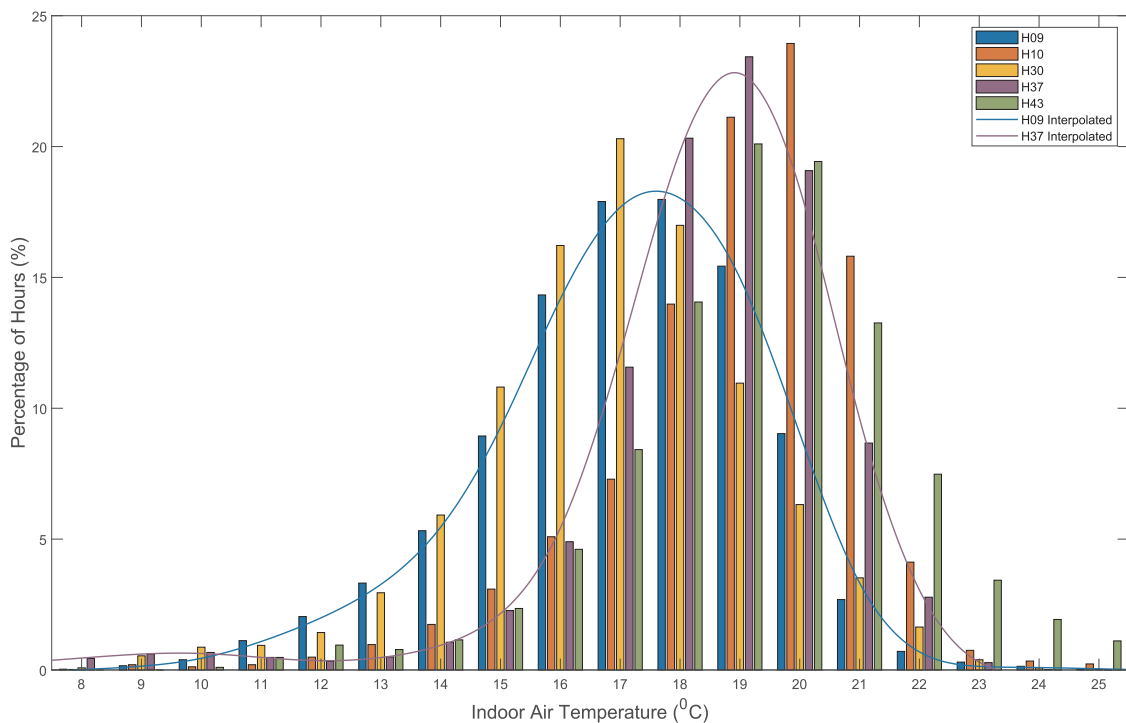

**Fig. 4.** The percentages of hours when the measured bulk average air temperature in each household were maintained at a certain temperature during the heating season.

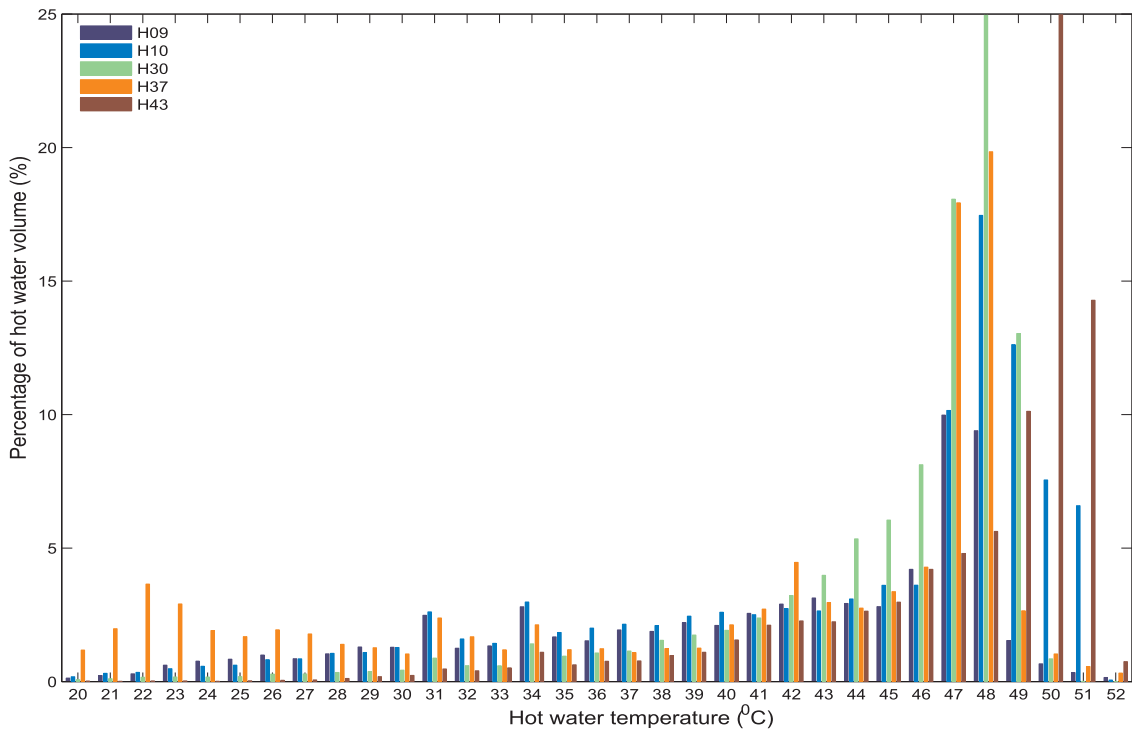

Fig. 5. The percentage of hot water volume at the specified temperature measured at the boiler outlet for 12 months of operation for each household.

3.1. Quantifying service for better decision making

Figs. 9 and 10 bring together the measure of service as defined by Eqs. (1) and (2) for space heating and hot water, respectively. In the plots the annual service delivered is calculated for each house, the TES capacity and the load shifting strategy. The minimum service levels are defined as any indoor air temperature at or above 18 °C: 100% service delivered by the new system delivers the same number of hours at or

above 18 °C as provided by the existing boiler fired system, when the heating system is active. Similarly, for the hot water system, 100% service is achieved when the new system delivers the same volume of hot water at or above 45 °C over the whole year. Note that the larger house, H43 struggles to maintain the internal space temperatures even with the maximum heat pump capacity (20 kW) considered in this study.

Fig. 9 focuses on space heating and hot water services, dividing the

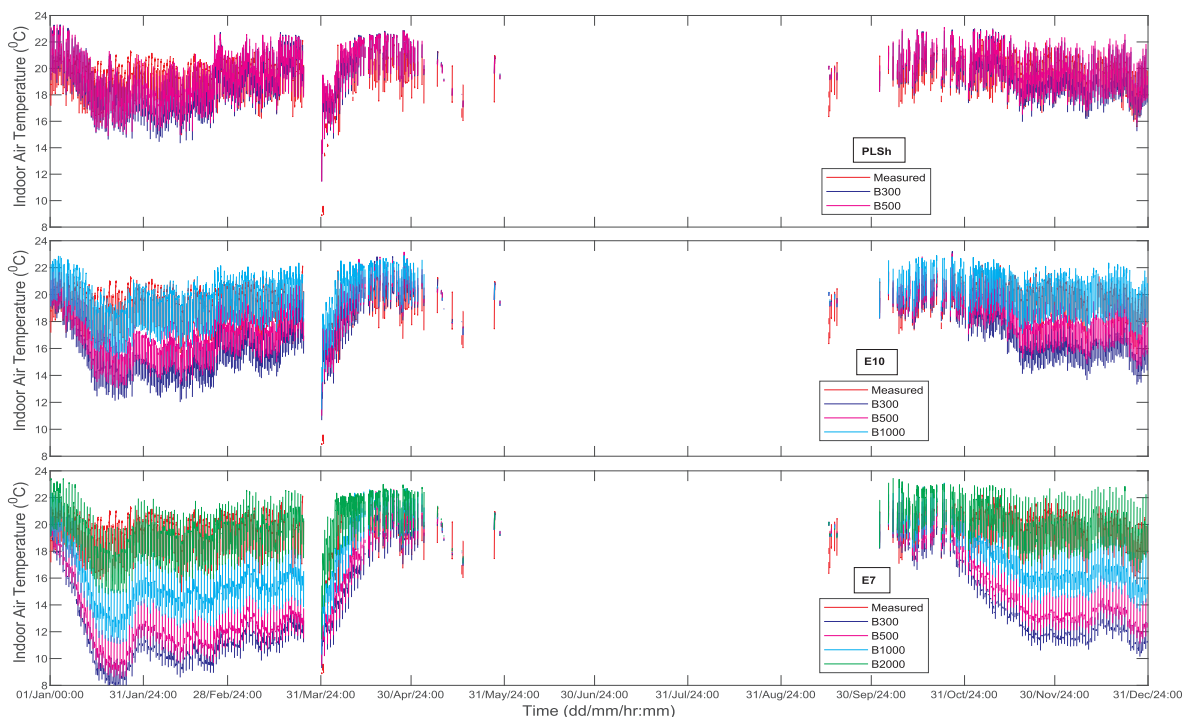

Fig. 6. Average temperature of H37 maintained with different buffer size and load shifting only during heating schedule operation. Each plot shows a different peak-load shifting option, and the resultant temperatures given the capacity of the thermal store, the smaller thermal stores can be seen to not perform as well.



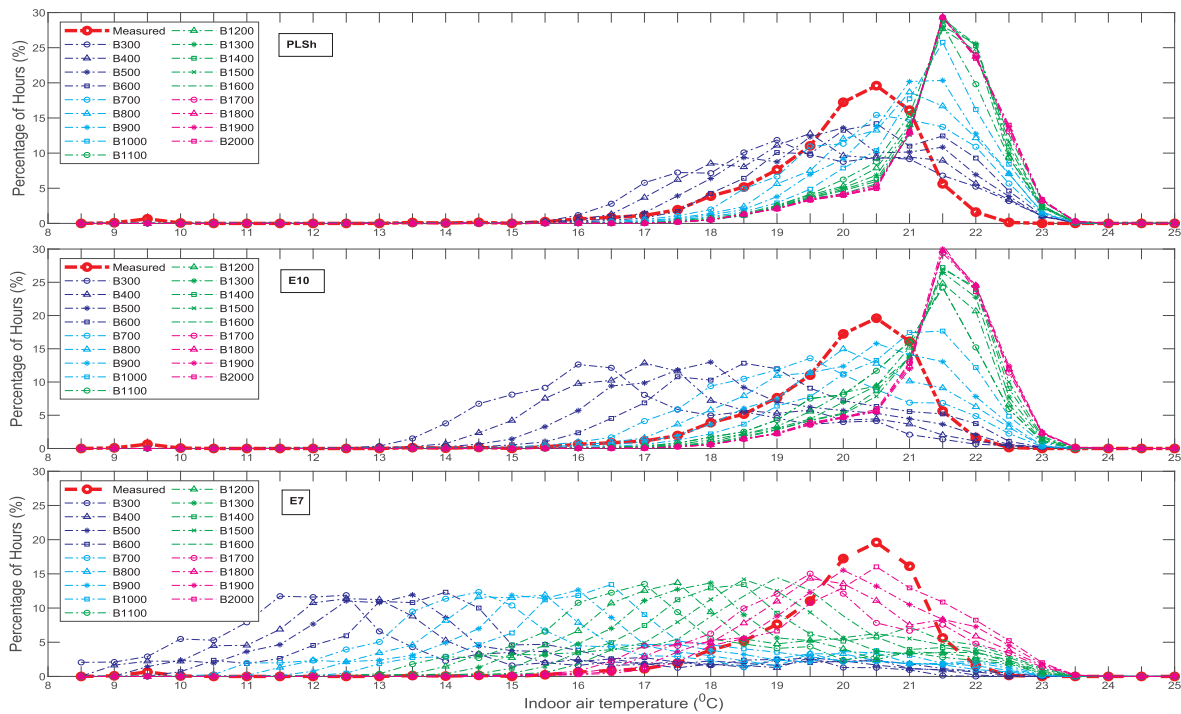

Fig. 7. Percentage of hours that H37 is maintained at certain average indoor air temperatures with PLSH (top), E10 (middle) and E7 (bottom).

measure of service based on the different tariffs. Fig. 9 indicates that the peak load shifting strategy is more favorable than E7 but the E10 strategy is quite divisive in terms of the service delivered. The figure also demonstrates the sensitivity of the space heating to the load shifting method; which is much more affected by the load shifting method than the hot water provision.

Comparing the different households for space heating and hot water provision, it can be seen that hot water in H30 has the lowest service in relation to all other houses, leading it to require a large TES volume. In

terms of space heating however, H43 offers the lowest service, followed by H10. This is to do with the average hot water consumption (see Fig. 2, bottom) with H30 consuming more on average than the other households, despite the lower number of occupants. This is because H30 has two significant peaks in their draw-off characteristics (between 9 h and 12 h and 7 h and 23 h, see Fig. 2), at periods in the day, which places greater demands on the storage. There also seems to be a ‘saturation’ point (around 0.2–0.3 L) for all households, where the volume of hot water consumed is low enough such that a 300 L is a sufficient

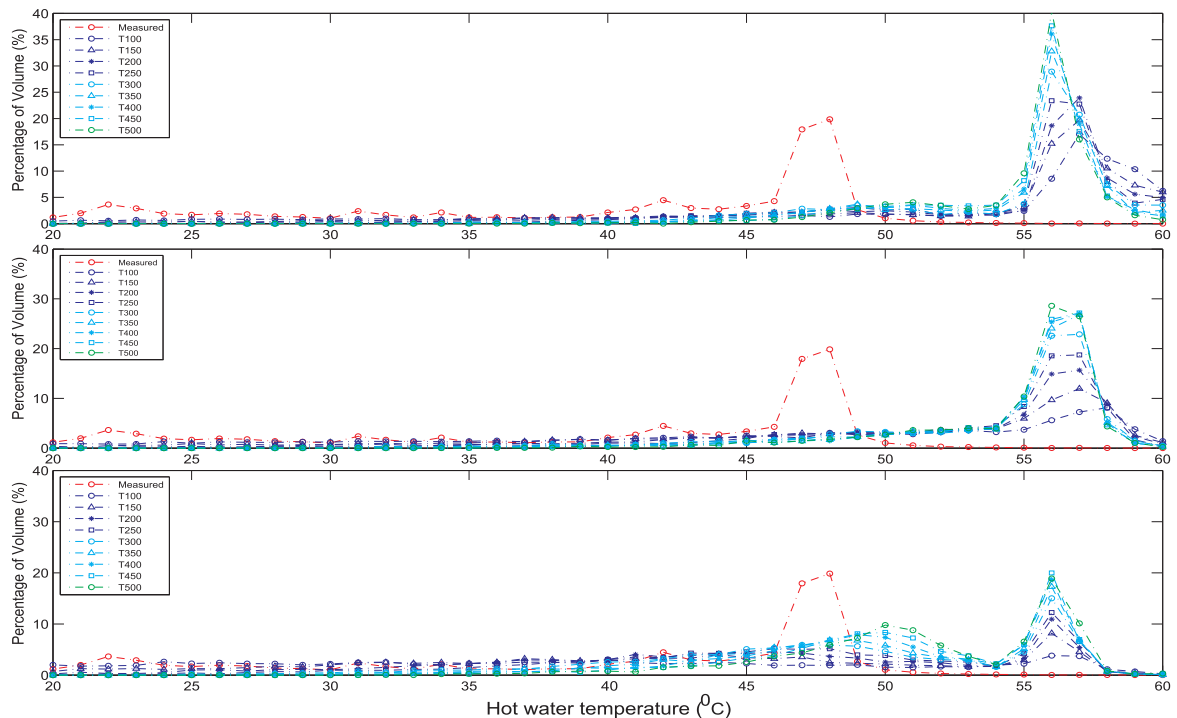
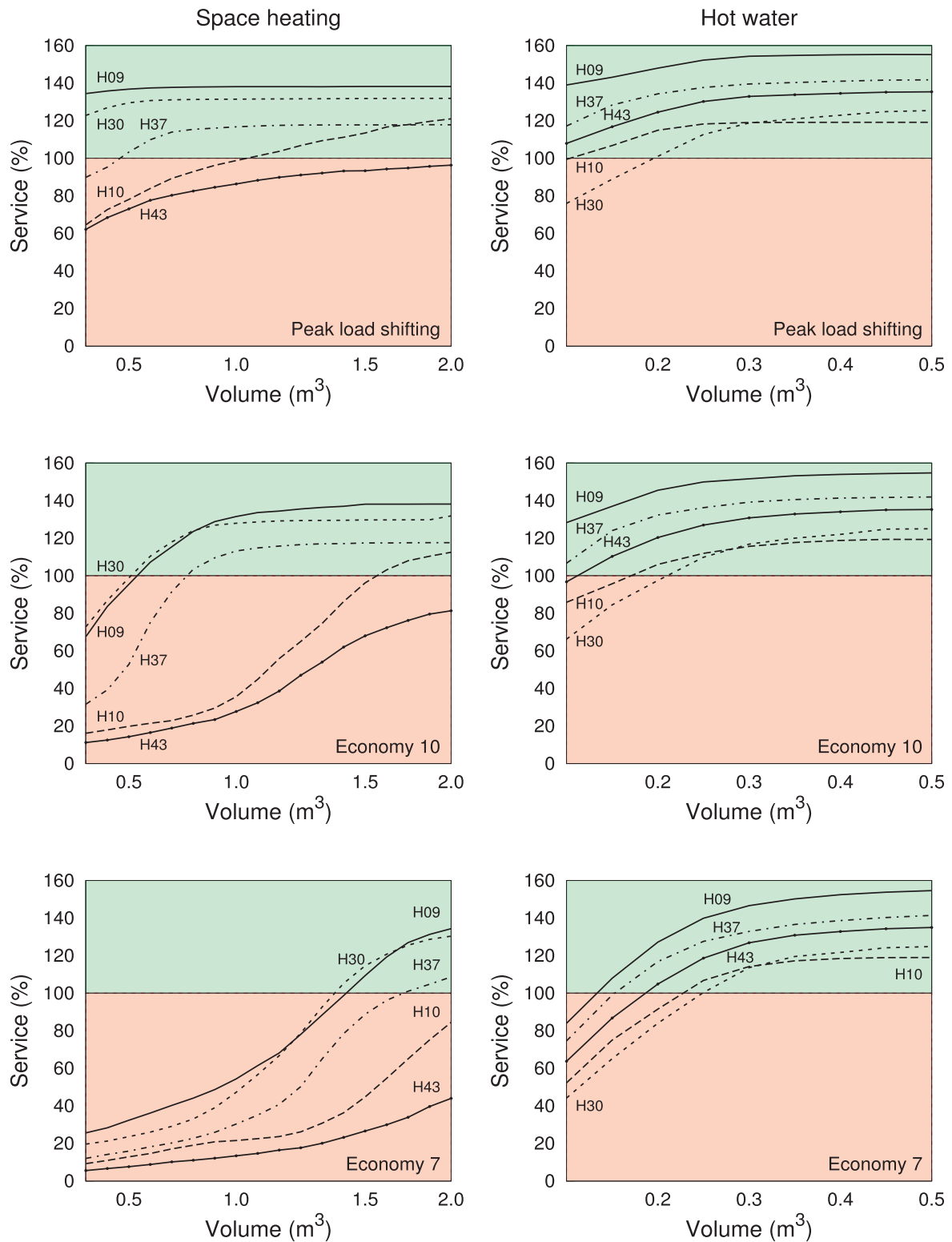

Fig. 8. Percentage of hot water volumes provide at a certain hot water temperature for H37 with PLSH (top), E10 (middle) and E7 (bottom).



**Fig. 9.** Space heating (left hand side) and hot water services (right hand side) provided for all households and buffer storage capacity in relation to the different load shifting strategies. The red area indicates poorer service than the existing gas-fired, combination boiler system and the green area as good, or better than the existing system.

capacity to supply all the hot water required in all houses.

Fig. 10 focusses on space heating and hot water services from the perspective of the different households. In terms of the space heating, H09 and H30 are the homes who are more used to cooler temperatures; these are less sensitive to both the capacity of the TES required and the load shifting strategy. A TES of 600 L for both would ensure equivalent

service is maintained, as long as they did not use the E7 strategy for electricity supply.

H37 would require an 800 L TES to give the same assurance of service, whereas with a greater load shifting challenges (E7) the TES of 1400–1800 L would be required to ‘future proof’ the current level of service provided through the new system. H10 and H43 would find the

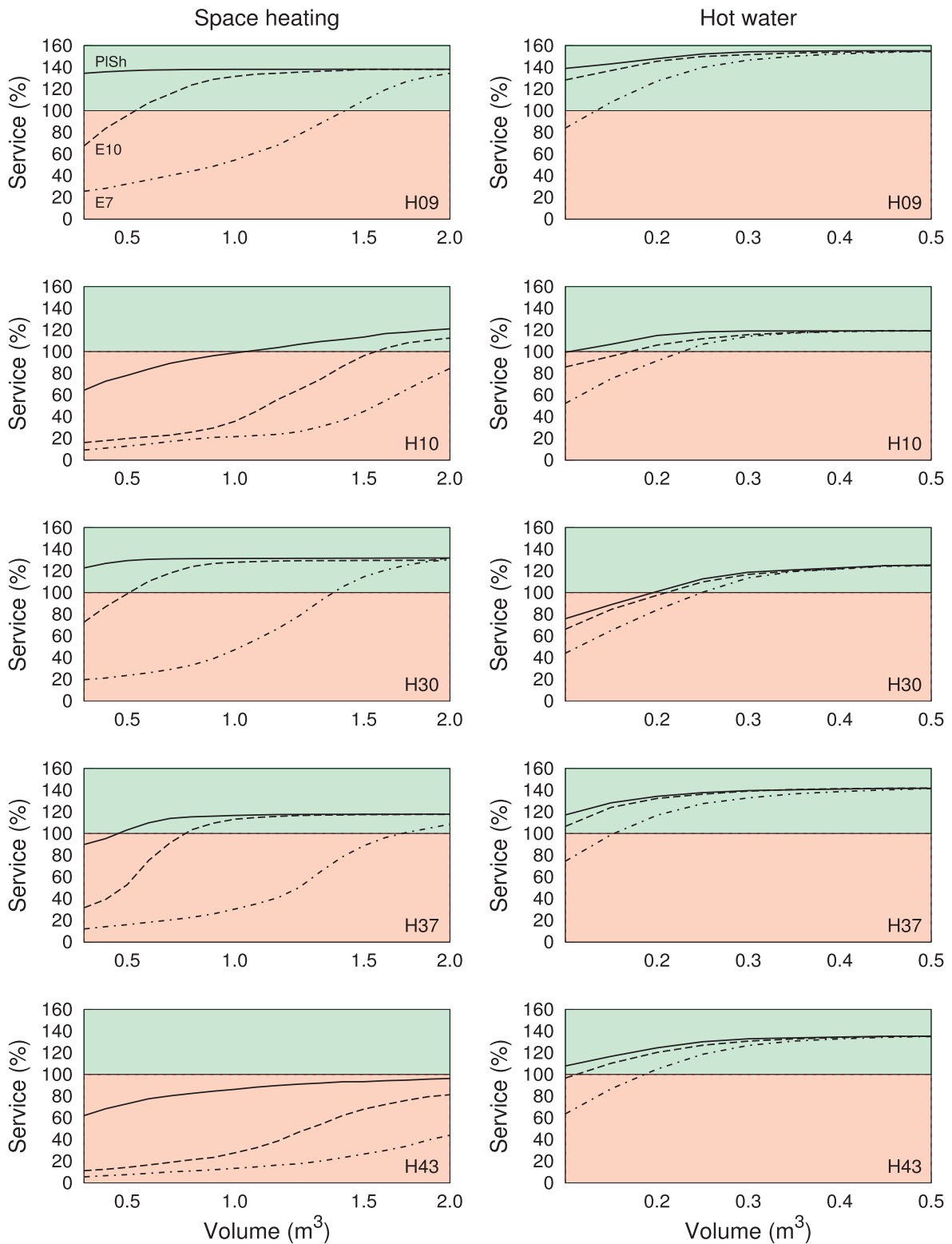

Fig. 10. Space heating (left hand side) and hot water services (right hand side) provided for the different load shifting strategy and buffer storage capacity in relation to the household. The red area indicates poorer service than the existing gas-fired, combination boiler system and the green area as good, or better than the existing system.

attainment of the current service level almost impossible, regardless of the TES volume. In H10, only the 1000 L TES volume and only the peak load shifting tariff would work. In this scenario, the householders would be forced to reduce their level of service: almost certainly leading to dissatisfaction with the installation.

In terms of the provision of hot water, H10 and H30 are more challenging to satisfy and H09 and H37 are more easily satisfied. H10 and H30 could be serviced with a standard cylinder (175 L). This volume would be similarly suitable with H10 and H43, but would deliver an increasing capacity and give more tariff flexibility. In the case of

H30, the 220–300 L would provide the greatest tariff flexibility. A 250 litre TES would maintain the service level for all homes in all peak load shifting strategies investigated here, not very much larger than a typical HWS cylinder installed today in the UK.

### 3.2. Cost of operation

Load shifting strategies may be implemented through variable pricing tariffs and Table 5 presents typical standard power price rates applied in the UK [51]. The price of gas is about 0.04 £/kWh. Three tariffs are offered: single rate (the same price over a 24 h period); two rates (night/day) tariffs; and OFF peak tariffs for certain hours.

The flexibility of the time of use tariffs, can help the householder to purchase electricity at a lower price, but the customer needs to be careful about when the energy is used: unit rates for energy used outside these time periods can be higher than usual. In this scenario, the tariff structures are assumed to be adhered to and the costs for each house are calculated for each tariff structure. The calculated operational costs also include the costs of consumption from the electricity appliances as measured from the buildings in 2013 and are presented in Fig. 11. H43 is an older property built in 1940 (see Table 1) and the occupants enjoy a warmer internal environment and hence the energy costs are correspondingly higher. In all but one home (i.e. H30), the switch to electrical supply of heat will mean an increase in fuels costs.

## 4. Discussion

The demand for electricity to generate heat for space heating and hot water is almost certain to exacerbate the peak demand [9]. Given the high cost of delivering increases in peak demand [52], greater flexibility will be necessary [6]. The need for the management of heat for space-heating and hot water demand will increase and so too will the demand to understand charge and discharge characteristics of the TES systems.

This study contributes to the development of this understanding by introducing the concept of ‘service’ that can be used in modelling to explore the difference between proposed new systems over the existing system that they may seek to replace. The measure of service is simple to implement and can be used in simulation, or applied to measurements. It can be used in the design of systems, or in the monitoring and feedback post installation.

Importantly, this study has shown that achieving desired service is not just a matter of sizing the capacity of the TES, but that the occupant preferences for heat in combination with the peak load shifting strategy are both important factors. By driving the simulation using real data and models of the specific household, much of the interplay between practice, system and building fabric is implicitly captured and hence more realistically influences the results of the modelling. In particular, the demand for heat is influenced by the fabric of the building, but also the heating schedules which relate to occupant use as well as other preferences that effect heat loss of which ventilation is known to be a significant factor [53] as is the variation in ventilation rate [54].

Because ASHP and TES are seen to be a key technology to enable the transition to renewable energy supply, it is imperative that these early systems are designed well and exceed the expectations of early adopters. Although this has been difficult to achieve to date [39]. We observed that the provision of HWS is not as difficult, or as problematic to realise as for space-heating with an ASHP: a ‘standard’ size thermal store during the design of a new system may work quite well. Given the constraints on the space needed for the TES in family homes, the volume should be minimised; however, the performance comes with increased sensitivity to user performances and the peak load shifting tariff.

### 4.1. Guidance for design

There is a lack of design guidance for these types of systems. [48,39] are two, but these fall short of the incorporation of TES systems. The approach here was to use simulation driven by monitoring data because this implicitly captures the idiosyncrasies of the householders use of systems. It is, however, computationally intensive and would need refinement for routine implementation, but the benefits of linking models to smart meter and home monitoring data are quite apparent. We highlight a number of observations for consideration during design:

- understand the electricity pricing tariffs available the demand at peak times for the household and map this against the appliance power consumption;
- treat E7 tariffs with caution;
- evaluate the patterns and magnitude of the current demand for heat to determine whether this is favorable; and,
- select a TES capacity that is sufficient to provide some ‘future proofing’ given the uncertainty for pricing structure.

It is also more productive to understand that the patterns of heat practices, while not intransigent, are hard to change and embedded in the routines that form daily life [55]. In terms of the design of systems, it is important to recognise that the recipient of the service are paramount to the success of the adoption of new electrically powered heating technologies. Occupants have different requirements and this will effect their assessment of the technology. The analysis demonstrated here that there are winners and losers from the new system in terms of how the service might be perceived: customers of new products and technologies are unlikely to invest in something that does not at least equal or better the current circumstance.

### 4.2. Limitations and future work

The work focused on a small sample of homes and so conclusions that can be drawn from the analysis are limited, however using models of real homes, driven by measured data and localised weather generates more precise insights that can be related more readily to the occupant. Our derivation of the measure of service proved to be useful, but it could be improved in a number of ways.

The implementation for space-heating utilised a common set point temperature of 20.5 °C for each house. This apes what an installer might do, being guided by best practice and considering installing a system that might outlast the current occupants: home ownership changes, but the design of the building services tends to occur at the end of life. In the analysis presented here, the measure of service favoured the homes that were maintained at cooler conditions. Although it is difficult to tell whether the lower temperatures are a result of the building and system, the preferences of the occupant, or indeed some combination of the two.

In reality, the service provided to the householder is the temperature of the water delivered to the faucet [56]. The source is connected to the end use via a pipe network and so the length, insulation, pattern

**Table 5**  
Standard domestic power rate electricity charges\*.

Tariffs Methods	Time periods	Price (pound/kWh)
Single rate tariff	00:00–24:00	0.122
Two rates tariff	08:00–22:00	0.174
	22:00–08:00	0.06
Off peak tariff	16:00–20:00	0.172
	20:00–16:00	0.106

\* British Gas supplier with effect from March, 2016

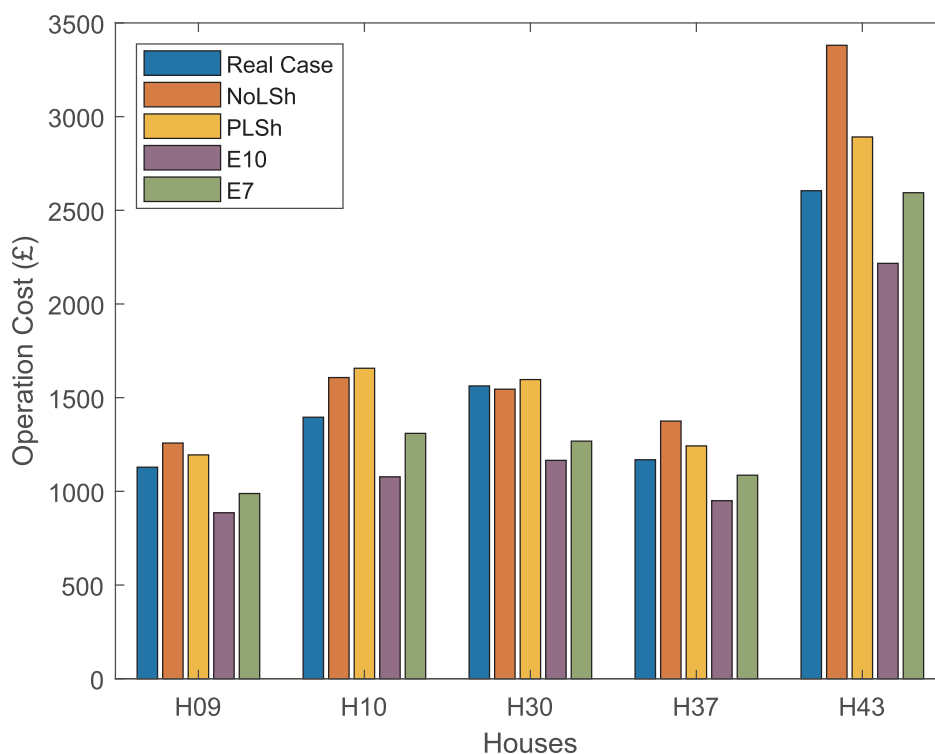

Fig. 11. The evaluation of operation costs for one year time period as operating with boiler and heat pump system under load shifting strategies.

of draw-off and use of water all effect the *value* of the hot water to the user and so in reality this is a far more complicated evaluation than the pragmatic approach adopted here. In this study, the measure was simplified because generally it is likely that cylinders will deliver a better service because of the higher storage temperatures required to prevent legionella. What the data in Fig. 5 demonstrated was the effect of shorter draw-offs from the combination boilers where the boiler does not have sufficient flow for a long enough period either fire the boiler, or to overcome the time constant of the heat exchanger [57].

Future work might be to reduce the detail in the simulation but to apply this to a wider range of properties operating under different weather conditions and also to link the simulation results to the occupants to understand their perspectives on service and what they might expect from the investment of a new heating system.

## 5. Conclusions

A detailed dynamic thermal and system simulation of five dwellings was developed in order to evaluate the impact on the space-heating and hot water service householders might expect to receive when they move from gas fired condensing combination boilers to an ASHP and TES system. Each model represented the fabric type surveyed from the actual buildings and the simulation was driven using local weather data, actual heating schedules, appliance electricity consumption and hot water draw-off patterns derived from monitoring data.

A novel approach to the quantification of service delivered from both the space-heating and hot water systems was presented and this was applied to the simulation data from over 400 simulations that exercised the system over three load shifting tariffs and a range of TES capacities to evaluate service provision. The service provision was compared to that provided by the gas fired boiler system as installed in each home in order to evaluate whether the householders would experience poorer, similar or better levels of service with the new system used under peak load shifting strategies.

A key finding is the sensitivity of the space heating to the load shifting method; which is shown to be much higher than the hot water

provision. The work also demonstrated that there was a variation in the service delivered to each home which, perhaps unsurprisingly, depends on the magnitude for the demand for heat.

However, if the electricity tariff strategy is adhered to strictly, i.e. only use is made of the lower cost, off peak supply, resolving the service problem is not simply a matter of increasing the size of the thermal store. The service level is very sensitive to the charging and discharging characteristics which results in some households struggling to maintain the internal environmental conditions for a comparable cost.

The selection of the electricity tariff and the use of heat are both important factors that should inform the design of new installations. If these are not accounted for, then there is a likelihood that the role of new technologies that replace conventional heating systems might cost more and deliver lower than expected performance in some homes which in turn will hamper the deployment of electrified heat in the UK.

## Acknowledgments

This paper is based in data created under the LEEDR: Low Effort Energy Demand Reduction Project based at Loughborough University, UK (EPSRC Grant No. EP/I000267/1). The work was undertaken as part of the Hothouse project (EPSRC Grant No. EP/M006735/1), part funded by the 4S-DHW project (EPSRC Grant No. EP/N021304/1) and completed in partnership with i-STUTE (EPSRC Grant No. EP/K011847/1).

## Appendix A. Supplementary material

Supplementary data associated with this article can be found, in the online version, at <https://doi.org/10.1016/j.apenergy.2019.113811>.

## References

- [1] DECC. Energy consumption in the UK- Domestic Data Tables, Department of Energy and Climate Change; 2011. <https://www.decc.gov.uk/en/content/cms/statics/publications/ecuk.aspx>.
- [2] DECC. Final UK greenhouse gas emissions. Data Tables, Department of Energy and

- Climate Change; 2011. <https://www.decc.gov.uk/en/content/cms/statics/publications/ecuk.aspx>.
- [3] DECC. Carbon valuation in UK policy appraisal: A revised Approach, Department of Energy and Climate Change; 2009. <https://www.decc.gov.uk/en/content/cms/statics/publications/ecuk.aspx>.
- [4] DECC. The UK's natinal strategy for climate change and energy; 2009. London: HMSO.
- [5] RHI. UK renewable heat incentive; 2009. <http://www.rhincenive.co.uk/>.
- [6] Eyre N, Baruah P. Uncertainties in energy demand in residential heating. Technical report; 2014.
- [7] Luickx Patrick J, Helsen Lieve M, D'haeseleer William D. Influence of massive heat-pump introduction on the electricity-generation mix and the ghg effect: comparison between belgium, france, germany and the netherlands. *Renew Sustain Energy Rev* 2008;12:2140–58.
- [8] Protopapadaki C, Saelens D. Heat pump and pv impact on residential low-voltage distribution grids as a function of building and district properties. *Appl Energy* 2017;192:268–81.
- [9] Grant Wilson IA, Rennie Anthony JR, Ding Yulong, Eames Philip C, Hall Peter J, Kelly Nicolas J. Historical daily gas and electrical energy flows through great britain's transmission networks and the decarbonisation of domestic heat. *Energy Policy* 2013;61:301–5.
- [10] Baetens R, De Coninck R, Van Roy J, Verbruggen B, Driesen J, Helsen L, et al. Assessing electrical bottlenecks at feeder level for residential net zero-energy buildings by integrated system simulation. *Appl Energy* 2012;96:74–83.
- [11] Wanga D, Parkinson S, Miao W, Jia H, Crawford, Djilali N. Hierarchical market integration of responsive loads as spinning reserve. *Appl Energy* 2013;104:229–38.
- [12] Wanga D, Parkinson S, Miao W, Jia H, Crawford, Djilali N. Online voltage security assessment considering comfort-constrained demand response control of distributed heat pump systems. *Appl Energy* 2012;96:104–14.
- [13] Ofgem. Energy Demand Research Project: Final Analysis; 2011.
- [14] Campillo J, Dahlquist E, Wallin F, Vassileva I. Is real-time electricity pricing suitable for residential users without demand-side management? *Energy* 2017;109:310–25.
- [15] Patteuw D, Henze GP, Helsen L. Comparison of load shifting incentives for low-energy buildings with heat pumps to attain grid flexibility benefits. *Appl Energy* 2016;167:80–92.
- [16] Stinner S, Huchtemann K, Müller D. Quantifying the operational flexibility of building energy systems with thermal energy storages. *Appl Energy* 2016;181:140–54.
- [17] Hedegaard K, Mathiesen BV, Lund H, Heiselberg P. Wind power integration using individual heat pumps analysis of different heat storage options. *Energy* 2012;47:284–93.
- [18] Hong J, Kelly NJ, Richardson I, Thomson M. Assessing heat pumps as flexible load. *Power Energy* 2012;227:30–42.
- [19] Fischera D, Rivera Torala T, Lindberga KB, Wille-Haussmann B, Madanib H. Investigation of thermal storage operation strategies with heat pumps in germany multifamily houses. *Energy Proc* 2014;58:137–44.
- [20] Glembin J, Büttner C, Steinweg J, Rockendorf G. Thermal storage tanks in high efficiency heat pump systems optimized installation and operation parameters. In: 2015 IRES conference energy procedia, vol. 73; 2015. p. 331–40.
- [21] Baeten B, Rogiers F, Helsen L. Reduction of heat pump induced peak electricity use and required generation capacity through thermal energy storage and demand response. *Appl Energy* 2017;195:184–95.
- [22] Atikol Ugur. A simple peak shifting DSM (demand-side management) strategy for residential water heaters. *Energy* 2013;62:435–40.
- [23] Coninck RD, Helsen L. Quantification of flexibility in buildings by cost curves - methodology and application. *Energy Build* 2016;162:653–65.
- [24] Hewitt Neil J. Heat pumps and energy storage – the challenges of implementation. *Appl Energy* 2012;89:37–44.
- [25] Renaldi R, Kiprakis A, Friedrich D. An optimisation framework for thermal energy storage integration in a residential heat pump heating system. *Appl Energy* 2017;186:520–9.
- [26] Schibuola L, Scarpa M, Tambani C. Demand response management by means of heat pumps controlled via real time pricing. *Energy Build* 2015;90:15–28.
- [27] Allison J, Cowie A, Galloway S, Hand J, Kelly NJ, Stephen B. Simulation, implementation and monitoring of heat pump load shifting using a predictive controller. *Energy Convers Manage* 2017;150:890–903.
- [28] Shove Elizabeth, Warde Alan. Inconspicuous consumption: the sociology of consumption, lifestyles, and the environment. *Sociological theory and the environment: classical foundations, contemporary insights*, 230; 2002.
- [29] Pink Sarah, Mackley Kerstin Lederh. Video and a sense of the invisible: approaching domestic energy consumption through the sensory home. *Sociol Res Online* 2012;17(1):3.
- [30] Paula Cosar-Jorda, Buswell Richard A, Webb Lynda, Leder Mackley Kerstin, Morosanu Roxana, Pink Sarah. Energy in the home: everyday life and the effect on time of use; 2013.
- [31] Frontier Economic. Future potential for DSR in GB. A report prepared for DECC by frontier economics supported by LCP and Sustainability; 2015.
- [32] Dunbabin P, Wickins C. Detailed analysis from the first phase of the energy saving trust's heat pump field trial. Department for Energy and Climate Change (DECC) Report, URN12D/018; 2012.
- [33] Arteconi A, Wewitt NJ, Polonara F. Domestic demand side management (DSM): role of heat pumps and thermal energy storage (TES) systems. *Appl Therm Eng* 2013;151:155–65.
- [34] DEE. International Energy Agency (IEA) HPP Annex 42: Heat Pumps in Smart Grids; 2014.
- [35] Beckman William A, Broman Lars, Fiksel Alex, Klein Sanford A, Lindberg Eva, Schuler Mattias, et al. Trnsys the most complete solar energy system modeling and simulation software. *Renewable Energy* 1994;5(1):486–8. *Climate change Energy and the environment*.
- [36] Buswell Richard, Webb Lynda, Cosar-Jorda Paula, Marini Dashamir, Brownlee Sandy, Thomson Murray, Yang Shuang-Hua, Kalawsky Roy. LEEDR project home energy dataset. 7; 2018.
- [37] Mitsubishi. Air to water heat pump systems: Data book. accessed April 2019. <https://library.mitsubishielectric.co.uk/pdf/book/EcodanPUHZDataBookFTC4#page-1>.
- [38] Marini D, C. Hei, R. Buswell, C. Hopfe, and D. Crawley. Modelling and calibration of a domestic building using high-resolution monitoring data. *Proceeding of Building Simulation and Optimization*, Newcastle, UK, 2016, 2016.
- [39] EST. The heat is on: heat pump field trials phase 2. Technical report; 2013.
- [40] BRE. Building Research Establishment. The Government's standard assessment procedure for energy ratings of dwellings; 2012. <http://www.bre.co.uk/filelibrary/SAP/2012/SAP-2012-9-92.pdf>.
- [41] Buswell RA, Marini D, Webb LH, Thomson M. Determining heat use in residential buildings using high resolution gas and domestic hot water monitoring. BS13, France; 2013.
- [42] Marini D, Buswell R, Hopfe C. The impact of electrical load shifting strategies on storage capacity and service provision of domestic hot water systems in residential buildings. In: *Proceeding of building simulation*, San Francisco, US, August 2017; 2017.
- [43] Kane T, Firth SK, Lomas KJ. How are UK homes heated? a city-wide, socio-technical survey and implications for energy modelling. *Energy Build* 2015;86:817–32.
- [44] Shipworth Michelle, Firth Steven K, Gentry Michael I, Wright Andrew J, Shipworth David T, Lomas Kevin J. Central heating thermostat settings and timing: building demographics. *Build Res Inf* 2010;38(1):50–69.
- [45] Marini D, Buswell R, Hopfe C. Estimating waste heat from domestic hot water systems in UK dwellings. In: *Proceeding of building simulation*, Hyderabad, India, December 2015; 2015.
- [46] Brecht B, Thomas C, Sébastien P, Frederik R, Lieve H, Sébastien P, et al. A validated model for mixing and buoyancy in stratified hot water storage tanks for use in building energy simulations. *Appl Energy* 2016;172:217–29.
- [47] Kelly NJ, Tuohy PG, Hawkesb AD. Performance assessment of tariff-based air source heat pump load shifting in a uk detached dwelling featuring phase change-enhanced buffering. *Appl Therm Eng* 2014;71:809–20.
- [48] CIBSE. Module 36: Air source heat pumps, 2012. <https://www.cibsejournal.com/cpd/modules/2012-01/> [accessed 15th May 2019].
- [49] RMCylinders. RMCylinders. <https://rmcylinders.com/products/heatpump-indirect-2-2-2/> [accessed April 2019].
- [50] Cosar-Jorda P, Buswell RA, Mitchell VA. Determining of the role of ventilation in residential energy demand reduction using a heat-balance approach. *Build Environ* 2018;144:508–18.
- [51] British Gas supplier - power price rates. <https://www.britishgas.co.uk/products-and-services/gas-and-electricity/our-energy-tariffs/Tariffs-A-Z.html> [accessed December 2016].
- [52] Sadinini SB, Boehm RF. Measurements and simulations for peak electrical load reduction in cooling dominated climate. *Energy* 2012;37(1):689–97. cited By 17.
- [53] Wei Shen, Jones Rory, de Wilde Pieter. Driving factors for occupant-controlled space heating in residential buildings. *Energy Build* 2014;70:36–44.
- [54] Cosar-Jorda Paula, Buswell Richard A. Estimating the air change rates in dwellings using a heat balance approach. *Energy Procedia* 2015;78:573–8. 6th International Building Physics Conference, IBPC 2015.
- [55] Shove E. Inconspicuous consumption: the sociology of consumption, lifestyles and environment. Rownan and Littlefield Publishers; 2001. p. 230–41.
- [56] Lutz JD, Renaldi A, Lekov Y Qin, Melody M. Hot water draw patterns in single-family houses: Findings from field studies Technical report Ernest Orlando Lawrence Berkeley National Laboratory; 2011.
- [57] Lutz JD. Water and energy wasted during residential shower events: Findings from a pilot field study of hot water distribution systems Technical report Lawrence Berkeley National Laboratory; 2011.