

# **Phenotypic and clinical outcome studies in amyloidosis and associated autoinflammatory diseases**

Taryn Alessandra Beth Youngstein

Doctor of Medicine

2019

University College London

UK National Amyloidosis Centre

Centre for Acute Phase Protein Research

Department of Medicine

Royal Free Hospital

Rowland Hill Street

London NW3 2PF

MD(Res)Thesis

## **Declaration**

I, Taryn Alessandra Beth Youngstein, confirm that the work presented in this thesis is my own.

Where information has been derived from other sources, it has been declared within the thesis.

## Abstract

### Background:

Systemic Amyloidosis results from the deposition of insoluble proteins as amyloid that disrupt organ function with time. Over 30 proteins are known to form amyloid and the identification of the precursor protein is essential as it guides treatment strategies. In AA amyloidosis, the precursor protein is Serum Amyloid A (SAA) which forms amyloid when raised in the blood over time. Thus, AA amyloidosis is a feared complication of the hereditary periodic fever syndromes and other autoinflammatory diseases.

### Aims:

1. To investigate transthyretin (TTR) amyloid and describe non-cardiac TTR deposition
2. To determine the role of carpal tunnel biopsy in diagnosis of TTR amyloid
3. Investigate and define the changing aetiology of AA amyloidosis
4. To investigate the safety of IL-1 antagonism for autoinflammatory disease in pregnancy
5. Delphi consensus study to define phenotype and management approaches in the autoinflammatory disease Deficiency of ADA2 (DADA2).

### Results and Conclusions

1. Non-cardiac TTR deposits were identified in 25 biopsies from the tissues of the bladder, duodenum, bone marrow, carpal tunnel tenosynovium, colon, stomach, lung, prostate, muscle. 84% had concurrent evidence of cardiac amyloid and 64% fulfilled consensus criteria for cardiac amyloidosis at presentation. Those with no cardiac involvement did not develop cardiac amyloid or amyloidosis over time.
2. 16.7% of 60 carpal tunnel biopsies from the general population contained evidence of amyloid. In those with amyloid mean age was 78.13 years vs. 58.40 years ( $p=0.0092$ ). 11.67% biopsies demonstrated definitive staining with TTR, median age 81.9 years, 71% female.
3. An increasingly prevalent cohort of AA amyloidosis of unknown aetiology was identified, with the novel finding that this group have a significantly

raised BMI ( $p < 0.0001$ ) suggesting that adipocyte production of pro-inflammatory cytokines may contribute to the raised circulating serum amyloid A levels. These findings suggest that AA amyloidosis may become another consequence of the global obesity epidemic.

4. Data on 31 maternal-exposed pregnancies from seven countries was collected, including the first data on canakinumab-exposed pregnancies. The first data on paternal exposure is described with no negative outcomes. Fourteen infants were breast fed with no complications. There were no reports of developmental delay, with follow-up of up to 10 years (median 18 months).
5. International expert consensus has been reached on the diagnosis and management of DADA2 but areas of contention, most notably regarding heterozygotes, remain and is the focus of ongoing further work.

## Impact statement

Data from this thesis has formed the basis of several publications in peer reviewed journals. Further, data presented herein has contributed to larger studies including via national and international collaborations. The data has also been presented at numerous national and international meetings and won prizes at both the XVth International Symposium on Amyloidosis 2016 and the 9<sup>th</sup> International Congress on FMF and Systemic Autoinflammatory Diseases 2017. In addition, the work on monogenic vasculitis received the Barbara Ansell Prize from the Royal Society of Medicine, London.

The data herein has impacted the field of amyloidosis and systemic autoinflammatory diseases by demonstrating:

1. TTR amyloid deposits outside of the heart have a high frequency of concurrent cardiac amyloid suggesting it is mandatory to type all amyloid tissue deposits and to investigate all cases for systemic amyloidosis.
2. The utility of carpal tunnel biopsy in identifying TTR amyloid deposition and facilitating the creation of a longitudinal cohort to inform the early natural history of TTR.
3. The novel clinical observation that obesity is a risk factor for systemic AA amyloidosis.
4. The first international cohort data on the use of interleukin-1 inhibitors in pregnancy and breast feeding.
5. The first international consensus data on the diagnosis, management and treatment of Deficiency of ADA2 (DADA2).

## **Prizes, Publications and Abstracts**

### **Prizes**

#### **Conference prize for best clinical oral presentation**

#### **9<sup>th</sup> International Congress on FMF and Systemic Autoinflammatory Diseases**

Northern Cypress, May 2017

International multi-centre study of pregnancy outcomes with interleukin-1 inhibitors

#### **Abstract prize**

#### **The XVth International Symposium on Amyloidosis**

Uppsala, Sweden, July 2016

Adipocyte production of inflammatory cytokines may be contributory in cases of AA Amyloidosis of unknown aetiology

#### **The Barbara Ansell Prize**

#### **Royal Society of Medicine**

London, November 2015.

Monogenic Vasculitis

### **Publications**

**Youngstein T**, Gilbertson JA, Hutt DF, Coyne MRE, Rezk T, Manwani R, Quarta CC, Lachmann HJ, Gillmore JD, Beynon H, Goddard N, Hawkins PN. Carpal Tunnel Biopsy Identifying Transthyretin Amyloidosis. *Arthritis Rheumatol.* 2017 Oct;69(10):2051. doi: 10.1002/art.40162. Epub 2017 Aug 31. PubMed PMID: 28556554.

**Youngstein T**, Hoffmann P, Gül A, Lane T, Williams R, Rowczenio DM, Ozdogan H, Ugurlu S, Ryan J, Harty L, Riminton S, Headley AP, Roesler J, Blank N, Kuemmerle-Deschner JB, Simon A, Woolf AS, Hawkins PN, Lachmann HJ. International multi-centre study of pregnancy outcomes with interleukin-1 inhibitors. *Rheumatology (Oxford).* 2017 Dec 1;56(12):2102-2108.

doi: 10.1093/rheumatology/kex305. PubMed PMID: 28968868; PubMed Central PMCID: PMC6251516.

### Co-authored manuscripts

Santo GC, Baldeiras I, Guerreiro R, Ribeiro JA, Cunha R, **Youngstein T**, Nanthapaisal S, Leitão J, Fernandes C, Caramelo F, Almeida MDR, Brás J, Santana I; Centro Hospitalar e Universitário de Coimbra. Adenosine Deaminase Two and Immunoglobulin M Accurately Differentiate Adult Sneddon's Syndrome of Unknown Cause. *Cerebrovasc Dis*. 2018;46(5-6):257-264.

doi: 10.1159/000495794. Epub 2019 Jan 15. PubMed PMID: 30645994.

Rezk T, Davenport A, Gan JJ, Lachmann HJ, Fontana M, Martinez-Naharro A, Sachchithanantham S, Guillotte C, Mahmood S, Petrie A, Whelan CJ, Pinney JH, Foard D, Lane T, **Youngstein T**, Wechalekar AD, Hawkins PN, Gillmore JD. Bioimpedance vector analysis for the detection of extracellular volume overload and sarcopenia in systemic AL amyloidosis. *Br J Haematol*. 2018 Nov 18. doi: 10.1111/bjh.15675. [Epub ahead of print] PubMed PMID: 30450572.

Manwani R, Foard D, Mahmood S, Sachchithanantham S, Lane T, Quarta C, **Youngstein T**, Rezk T, Lachmann HJ, Gillmore JD, Fontana M, Whelan C, Hawkins PN, Wechalekar A. Rapid hematologic responses improve outcomes in patients with very advanced (stage IIIb) cardiac immunoglobulin light chain amyloidosis. *Haematologica*. 2018 Apr;103(4):e165-e168. doi: 10.3324/haematol.2017.178095. Epub 2018 Jan 5. PubMed PMID: 29305414; PubMed Central PMCID: PMC5865426.

Hutt DF, Fontana M, Burniston M, Quigley AM, Petrie A, Ross JC, Page J, Martinez-Naharro A, Wechalekar AD, Lachmann HJ, Quarta CC, Rezk T, Mahmood S, Sachchithanantham S, **Youngstein T**, Whelan CJ, Lane T, Gilbertson JA, Rowczenio D, Hawkins PN, Gillmore JD. Prognostic utility of the Perugini grading of 99mTc-DPD scintigraphy in transthyretin (ATTR) amyloidosis and its relationship with skeletal muscle and soft tissue amyloid. *Eur Heart J Cardiovasc Imaging*. 2017 Dec 1;18(12):1344-1350. doi: 10.1093/ehjci/jew325. PubMed PMID: 28159995.

Rowczenio DM, Pathak S, Arostegui JI, Mensa-Vilaro A, Omoyinmi E, Brogan P, Lipsker D, Scambler T, Owen R, Trojer H, Baginska A, Gillmore JD, Wechalekar AD, Lane T, Williams R, **Youngstein T**, Hawkins PN, Savic S, Lachmann HJ. Molecular genetic investigation, clinical features, and response to treatment in 21 patients with Schnitzler syndrome. *Blood*. 2018 Mar 1;131(9):974-981. doi:10.1182/blood-2017-10-810366. Epub 2017 Dec 28. PubMed PMID: 29284595; PubMed Central PMCID: PMC5877784.

Rezk T, Lachmann HJ, Fontana M, Sachchithanantham S, Mahmood S, Petrie A, Whelan CJ, Pinney JH, Foard D, Lane T, **Youngstein T**, Wechalekar AD, Bass P, Hawkins PN, Gillmore JD. Prolonged renal survival in light chain amyloidosis: speed and magnitude of light chain reduction is the crucial factor. *Kidney Int.* 2017 Dec;92(6):1476-1483. doi: 10.1016/j.kint.2017.05.004. Epub 2017 Jul 18. PubMed PMID: 28729034.

Lane T, Pinney JH, Gilbertson JA, Hutt DF, Rowczenio DM, Mahmood S, Sachchithanantham S, Fontana M, **Youngstein T**, Quarta CC, Wechalekar AD, Gillmore JD, Hawkins PN, Lachmann HJ. Changing epidemiology of AA amyloidosis: clinical observations over 25 years at a single national referral centre. *Amyloid.* 2017 Sep;24(3):162-166. doi: 10.1080/13506129.2017.1342235. Epub 2017 Jul 7. PubMed PMID: 28686088.

Quarta CC, Gonzalez-Lopez E, Gilbertson JA, Botcher N, Rowczenio D, Petrie A, Rezk T, **Youngstein T**, Mahmood S, Sachchithanantham S, Lachmann HJ, Fontana M, Whelan CJ, Wechalekar AD, Hawkins PN, Gillmore JD. Diagnostic sensitivity of abdominal fat aspiration in cardiac amyloidosis. *Eur Heart J.* 2017 Jun 21;38(24):1905-1908. doi: 10.1093/eurheartj/ehx047. PubMed PMID: 28605421; PubMed Central PMCID: PMC5837229.

Carter JP, Foard D, Rannigan L, Aliaz K, Mahmood S, Sachchithanantham S, Fontana M, Quarta C, Martinez De Azcona Naharro A, **Youngstein T**, Rezk T, Wechalekar A, Whelan C, Lachmann H, Hawkins P, Gillmore J, Lane T. A good clonal response to chemotherapy in AL amyloidosis is associated with improved quality of life and function at 1 year. *Amyloid.* 2017 Mar;24(sup1):72-73. doi: 10.1080/13506129.2017.1295944. PubMed PMID: 28434320.

Rezk T, Whelan CJ, Lachmann HJ, Fontana M, Sachchithanantham S, Mahmood S, Khan F, Khiani R, Tomson J, **Youngstein T**, Gillmore JD, Hawkins PN, Wechalekar AD. Role of implantable intracardiac defibrillators in patients with cardiac immunoglobulin light chain amyloidosis. *Br J Haematol.* 2018 Jul;182(1):145-148. doi: 10.1111/bjh.14747. Epub 2017 May 9. PubMed PMID: 28485005.

Nanthapaisal S, Murphy C, Omoyinmi E, Hong Y, Standing A, Berg S, Ekelund M, Jolles S, Harper L, **Youngstein T**, Gilmour K, Klein NJ, Eleftheriou D, Brogan PA. Deficiency of Adenosine Deaminase Type 2: A Description of Phenotype and Genotype in Fifteen Cases. *Arthritis Rheumatol.* 2016 Sep;68(9):2314-22. doi: 10.1002/art.39699. PubMed PMID: 27059682.



## **International Oral Presentations**

### **Vasculitis 2019, Philadelphia, USA, commencing April 2019**

Diagnosis and treatment of DADA2

### **2<sup>nd</sup> International conference on Deficiency of ADA2. November 2018. Bethesda, USA**

Towards consensus? Results of a Global Delphi Study on DADA2

### **9<sup>th</sup> International Congress on FMF and Systemic Autoinflammatory Diseases, Northern Cypress, May 2017**

International multi-centre study of pregnancy outcomes with interleukin-1 inhibitors

### **9<sup>th</sup> International Congress on FMF and Systemic Autoinflammatory Diseases, Northern Cypress, May 2017**

Adipocyte production of inflammatory cytokines may be contributory in cases of AA Amyloidosis of unknown aetiology

## **National Oral Presentations**

### **British Peripheral Nerve Society Annual Meeting, London, 2015**

Carpal tunnel biopsy as a diagnostic tool to identify early cases of cardiac amyloidosis – results of a pilot study

Data from this thesis was also presented in abstract form at The British Society of Rheumatology, Birmingham, UK; 2017, European League Against Rheumatism, Madrid, Spain, 2017, 8<sup>th</sup> International Congress on FMF and Systemic Autoinflammatory Diseases, Dresden, Germany 2015

## **Ethical Approval**

The individuals whose data has been used in the clinical research studies described in this thesis gave explicit informed consent by signing a consent form whilst visiting the centre.

The consent form was approved by the Royal Free Hospital Ethics Committee (REC Ref 06/Q0501/42).

The dosage and administration of radioactive isotopes were approved by the Administration of Radioactive Substances Advisory Committee of the Department of Health.

## Acknowledgements

I wish to thank Dr Helen Lachmann for her support and supervision, and to Professor Philip Hawkins for his supervision, wise counsel and support. I am grateful to Professor Sir Mark Pepys for the opportunity to work at the inspiring environment of the UK National Amyloidosis Centre and Centre for Acute Phase Protein Research, especially during the time of first in man studies of novel therapeutics which taught me much about the endeavour from bench to bedside.

There are many people at the National Amyloidosis Centre to thank for their help and guidance: Professor Ashutosh Wechalekhar, Professor Julian Gillmore, Dr Carol Whelan, Dr Marianna Fontana, Dr Cristina Quarta, Dr Richa Manwani, Dr Tamer Rezk, Dr Shameen Mahmood, Dr Sajitha Sachchithananthan, Dr Dorota Rowczenio and her genetics team, Janet Gilbertson and her histopathology team, David Hutt and his radiographer team, Dr Thirusha Lane and her brilliant nursing and HCA team. Beth Jones, Jean Berkley, Sarah Louth, Adrian Machin and Islam Noor. I would also like to thank Professor Paul Brogan and Dr Sira Nanthapaisal from Great Ormond Street Hospital and Dr Chip Chambers of the DADA2 Foundation. I would also like to thank Mr Nicholas Goddard of the Royal Free Hospital for his expertise in carpal tunnel surgery and interest in amyloidosis.

I would like to thank the patients of the National Amyloidosis Centre and their families; the burden of rare disease is heavy and their courage, good humour and enthusiasm for our research was humbling.

Finally, thank you to my current colleagues at the Hammersmith Hospital who have supported me to complete this thesis and to my family and Bijan and Max, who have shown patience and understanding during this period of research.

## Contents

Declaration.....	2
Abstract.....	3
Impact statement .....	5
Prizes, Publications and Abstracts.....	6
Ethical Approval.....	10
Acknowledgements.....	11
Contents .....	12
List of Tables.....	17
List of Figures .....	19
Abbreviations .....	23
Chapter One: .....	27
Introduction .....	27
An introduction to amyloidosis.....	28
Amyloid precursor proteins and fibril formation .....	28
Epidemiology of amyloidosis .....	33
Diagnosis and Assessment of Amyloidosis .....	35
Symptoms and clinical signs of amyloidosis .....	35
Histology .....	35
Proteomics.....	39
Gene Sequencing.....	39
Amyloid Specific Imaging.....	39
<sup>123</sup> Iodine Serum Amyloid P Scintigraphy.....	40
Cardiac Imaging.....	42
Amyloid subtypes .....	45
Localised Amyloid.....	45
Systemic Amyloidosis .....	45

AL Amyloidosis .....	46
Transthyretin Amyloidosis.....	48
β2-microglobulin Amyloidosis .....	49
ApoAI Amyloidosis.....	49
ALect 2 Amyloidosis .....	50
Hereditary Fibrinogen Amyloidosis .....	51
Gelsolin Amyloidosis.....	51
Lysozyme Amyloidosis .....	52
AA Amyloidosis.....	52
Novel Treatment for Amyloidosis.....	55
Monogenic Systemic Autoinflammatory diseases .....	56
The Pathogenesis of Autoinflammatory Diseases .....	58
The Periodic Fever Syndromes .....	62
Aims and Scope of Thesis .....	71
Chapter Two: .....	73
Materials and Methods.....	73
Study Design .....	74
Patients .....	74
Histopathology and immunohistochemistry .....	74
Biochemical and haematological data .....	75
Serum Amyloid A Protein immunoassay .....	75
Genetic analysis .....	76
Laser capture microdissection and proteomic mass spectrometry .....	77
SAP Scintigraphy .....	77
<sup>99m</sup> Tc-DPD scintigraphy .....	78
Chapter Three:.....	79

The clinical significance of transthyretin amyloid deposits in non-cardiac tissues	79
Introduction.....	80
Patients and Methods.....	89
Patients:.....	89
Laboratory Procedures: .....	89
Clinical assessments and diagnostic procedures: .....	89
Statistical Analysis: .....	90
Results .....	91
Cohort Characteristics .....	91
Cardiac Investigations .....	95
Survival.....	99
Discussion.....	101
Chapter Four:.....	104
Carpal tunnel biopsy as a diagnostic tool to identify early cases of cardiac transthyretin amyloidosis .....	104
Introduction.....	105
Results: .....	111
Whole Cohort Characteristics: .....	111
Case Vignettes .....	115
Discussion:.....	119
Chapter Five: .....	126
The changing aetiology of AA Amyloidosis .....	126
Introduction.....	126
The UK NAC systemic AA amyloidosis cohort.....	127
Methods .....	131
Results: .....	132
Whole cohort characteristics:.....	132

Study cohort characteristics.....	134
Survival.....	137
Comparisons with other cohorts .....	138
Discussion.....	139
Case vignette.....	141
Chapter Six: .....	144
Interleukin-1 inhibitors in Pregnancy .....	144
Introduction.....	145
Patients and methods.....	146
Results .....	149
Canakinumab.....	149
Anakinra.....	151
Discussion.....	157
Chapter Seven:.....	163
Deficiency of Adenosine Deaminase 2 (DADA2) .....	163
Introduction.....	164
Phenotypic characterisation of the Pro251Leucine mutation.....	169
Introduction .....	169
Methods.....	172
Results.....	174
Discussion .....	181
International Delphi survey for the classification of the diagnosis, management and follow-up of those with suspected DADA2 and their relatives .....	182
Introduction.....	182
Methods.....	182
Results.....	184
Discussion .....	199

Chapter Eight: .....	204
General Conclusions & Future Directions .....	204
References.....	208



## List of Tables

Table 1.1: Common forms of systemic amyloidosis, their precursor proteins, clinical characteristics and treatment

Table 1.2: Genetic and clinical characteristics of monogenic autoinflammatory diseases

Table 2.1: Commercially available PCR kits used in the amplification of gene sequences in hereditary amyloidosis and periodic fever syndromes

Table 3.1: Cardiac assessment in ATTRwt

Table 3.2: Baseline demographics and histopathology and presence of cardiac involvement

Table 3.3: Assessment of cardiac function

Table 3.4: Summary of cardiac involvement, progression, follow up and survival

Table 4.1: Commonly recognised causes of Carpal Tunnel Syndrome

Table 4.2: Whole cohort characteristics

Table 4.3: Characteristics of cohort with amyloid identified in the carpal tunnel

Table 4.4: Characteristics of those with TTR deposition in the carpal tunnel

Table 4.5: Cardiac assessment of those with ATTR in the carpal tunnel

Table 5.1: Idiopathic and control cohort baseline characteristics and BMI

Table 5.2: Median baseline demographics of the three reported cohorts where BMI in those with AA amyloidosis have been investigated

Table 6.1: Licensed interleukin-1 antagonists and evidence for their use in pregnancy and lactation

Table 6.2 Canakinumab exposed pregnancy and breast-feeding outcomes

Table 6.3 Anakinra exposed pregnancy and breast-feeding outcomes

Table 6.4 Pregnancies with paternal exposure to anakinra or canakinumab at conception

Table 6.5 Summary of previously published data on anakinra use in pregnancy

Table 7.1: Baseline characteristics of first-degree family members with ADA2 mutations

Table 7.2: Summary characteristics of published Pro251Leu/Arg169Glu compound heterozygotes from Navon Elkan *et al* 2014

Table 7.3: Responses to the Question: Which do you consider to be presenting symptoms/signs of DADA2?

## List of Figures

Figure 1.1: Characteristic Congo red binding and green birefringence of amyloid when viewed under cross-polarised light microscopy

Figure 1.2: Cases of amyloidosis referred to NAC over 25 years

Figure 1.3: Schedule of clinical assessment and investigations at the UK National Amyloidosis Centre

Figure 1.4: <sup>123</sup>Iodine Serum Amyloid P Scintigraphy in a patient with AL amyloidosis

Figure 1.5: Cause of underlying inflammation in 659 cases of systemic AA amyloidosis in the NAC cohort

Figure 1.6: Actions of interleukin 1 $\beta$

Figure 1.7: The NLRP3 inflammasome

Figure 3.1: Schematic representation of TTR fibrillogenesis

Figure 3.2: <sup>99m</sup>Tc-DPD Whole Body Scintigraphy depicting Perugini grades 1 to 3 in those presenting following the identification of TTR amyloid in non-cardiac tissue

Figure 3.3: Kaplan–Meier survival from diagnosis in patients with TTR identified in non-cardiac tissue

Figure 4.1: The Carpal Tunnel Syndrome; anatomy and surgical decompression

Figure 4.2: Investigations of Case 1 revealing TTR amyloid in the carpal tunnel biopsy and cardiac amyloidosis on <sup>99m</sup>Tc–DPD

Figure 4.3: Histopathological sections from case 2 demonstrating amyloid of the TTR type

Figure 4.4: <sup>99m</sup>Tc–DPD and SPECT CT images of Case 2

Figure 4.5: Proposed natural history of ATTRwt amyloidosis

Figure 4.6: Flow-chart for prospective study of the prevalence of TTR deposits in the carpal tunnel and long-term study to investigate the natural history of ATTRwt

Figure 5.1: SAP scintigraphy showing regression of amyloid following suppression of serum SAA levels

Figure 5.2: Underlying aetiology of inflammation in 659 cases of systemic AA amyloidosis seen at the NAC over 27 years

Figure 5.3: Changing aetiology of NAC AA amyloidosis cohort over 27 years

Figure 5.4: Control AA amyloidosis cohort

Figure 5.5: Body mass index between idiopathic and control groups

Figure 5.6: SAA and BMI response to immunosuppression and bariatric surgery in a 32-year-old female with idiopathic inflammation

Figure 5.7: Proposed algorithm for the management of those with raised BMI an acute phase response and suspected AA amyloidosis

Figure 7.1: Cecr1b-knockdown Zebrafish

Figure 7.2: The ADA2 Protein

Figure 7.3: Pedigree diagram of Pro251Leu family, including genotype status of all available relatives

Figure 7.4: Photographs of Brother 1 during disease exacerbation showing livedo racemosa and arthritis

Figure 7.5: Baseline imaging in first-degree family members with ADA2

Figure 7.6: Plasma ADA2 activity levels compared to 13 healthy adult controls with homozygous wild type ADA2 genotypes

Figure: 7.7: Responses to Question: How many cases of confirmed DADA2 cases have you previously managed?

Figure 7.8: Do you routinely refer to a geneticist for genetic counselling at your centre?

Figure 7.9: Responses to Question: Are you able to perform the gene sequencing at your centre?

Figure 7.10: Responses to Question: Are you able to measure ADA2 activity levels?

Figure 7.11: Responses to Question: What do you consider to be the gold standard diagnostic test/(s) for DADA2?

Figure 7.12: Responses to Question: What do you consider to be a positive test for DADA2 in a symptomatic patient?

Figure 7.13: Responses to Question: True heterozygotes can have DADA2?

Figure 7.14: Responses to Question: I measure the following at baseline diagnosis of DADA2

Figure 7.15: Responses to Question: I request the following investigations at baseline, irrespective of symptoms

Figure 7.16: Responses to Question: I request the following imaging investigations only if the patient is symptomatic in that organ system

Figure 7.17: Responses to Question: What investigations do you use for follow-up of patients on treatment

Figure 7.18: Responses to Question: What do you consider a raised CRP in DADA2?

Figure 7.19: Responses to Question: In those with a confirmed diagnosis of DADA2 and established on treatment with normal CRP would you routinely use imaging if asymptomatic at follow-up?

Figure 7.20: Responses to Question: In an acute event i.e. stroke in a proven case of DADA2 I would treat with the following

Figure 7.21: Responses to Question: For the treatment of DADA2 my first-line treatment is

Figure 7.22: Responses to Question: If funding was no object my preferred long-term treatment in DADA2 would be:

Figure 7.23: Responses to Question: Anti-TNF, if effective, should be given

Figure 7.24: Responses to Question: If no history of haemorrhage, such as haemorrhagic stroke, based on currently available evidence I routinely anti-coagulate my patients with DADA2

Figure 7.25: Responses to Question: If no history of haemorrhage, such as haemorrhagic stroke, based on currently available evidence I routinely give anti-platelet agents to my patients with DADA2

Figure 7.26: Responses to Question: Genetic screening, please select only one choice that best reflects your current practice

Figure 7.27: Responses to Question: In asymptomatic relatives with a mutation/s in the CECR1 gene, in an ideal world I would

Figure 7.28: Responses to Question: Would you follow-up asymptomatic relatives with heterozygous mutations in CECR1?

Figure 7.29: Responses to Question: In which circumstances would you follow-up carriers of mutations in DADA2:

Figure 7.30: Proposed algorithm for the investigation and management of those with suspected DADA2

## Abbreviations

AA Systemic Amyloid A Amyloidosis

AApoA1 Hereditary Apolipoprotein AI Amyloidosis

AApoAII Hereditary Apolipoprotein AII Amyloidosis

A $\beta$ 2M  $\beta$ 2-Microglobulin Amyloid

ADA2 Adenosine Deaminase 2

AOSD Adult Onset Stills Disease

AF Atrial Fibrillation

AFib Hereditary Fibrinogen A  $\alpha$ -chain Amyloidosis

AGel Gelsolin Amyloidosis

AL Light Chain Amyloidosis

ALys Hereditary Lysozyme Amyloidosis

ALP Alkaline Phosphatase

Anti-TNF Anti-Tumour Necrosis Factor

ASCT Autologous Stem Cell Transplantation

ATTRwt Wild Type Transthyretin Amyloidosis

BJP Bence Jones Protein

BMI Body Mass Index

BNP Brain Natriuretic Peptide

BP Blood Pressure

CAPS Cryopyrin Associated Periodic Syndrome

CANDLE Chronic atypical neutrophilic dermatosis with lipodystrophy and elevated temperature syndrome

CVA Cerebrovascular Accident

CMR Cardiac Magnetic Resonance imaging

CR Complete (light chain) Response

CRP C-Reactive Protein

CPHPC R-1-[6-[R-2-carboxy-pyrrolidin-1-yl]-6-oxo-hexanoyl] pyrrolidine-2-carboxylic acid

DADA2 Deficiency of ADA2

DAMPs Damage-associated Molecular Patterns

dFLC Free Light Chain difference

DIRA Deficiency of the IL-1 receptor antagonist

DITRA Deficiency of the IL-36 receptor antagonist

DNA Deoxyribonucleic acid

DPD 99mTc-3, 3-diphosphono-1, 2-propanodicarboxylic acid

ECG Electrocardiogram

EDTA Ethylenediaminetetraacetic Acid

EF Ejection Fraction

eGFR Estimated Glomerular Filtration Rate

ESRF End Stage Renal Failure

FAP Familial Amyloid Polyneuropathy

FCAS2 Familial Cold Autoinflammatory Syndrome-2

FFP Fresh Frozen Plasma

FLC Free Light Chain

FMF Familial Mediterranean Fever

GI Gastro-Intestinal

HAMPs Homeostasis-Altering Molecular Processes

HIDs Hyper IgD Syndrome (see MKD)

HR Heart Rate

H<sub>2</sub>O<sub>2</sub> Hydrogen Peroxide

IBD Inflammatory Bowel Disease



IFN Type 1 Interferon

IHC Immunohistochemistry

IL-1 Interleukin-1

IL-6 Interleukin-6

IRAS The Integrated Research Application System

IVDU Intravenous Drug Use

IVIG Intravenous Immunoglobulin

IVSd Interventricular Septal Thickness in Diastole

LGE Late Gadolinium Enhancement

JIA Juvenile Idiopathic Arthritis

MKD Mevalonate Kinase Deficiency

MGUS Monoclonal Gammopathy of Undetermined Significance

NHS National Health Service

NAC UK National Amyloidosis Centre

NT-proBNP N-Terminal pro- Brain Natriuretic Peptide

NYHA New York Heart Association classification

PAAND Pyrin associated autoinflammation with neutrophilic dermatosis

PAMPs Pathogen-Associated Molecular Patterns

PAPA Pyogenic arthritis, pyoderma gangrenosum and acne

PCD Plasma Cell Dyscrasia

PCR Polymerase Chain Reaction

PBS Phosphate-Buffered Saline

PAN Polyarteritis nodosum

PR Partial (light chain) response

RA Rheumatoid Arthritis

SAA Serum Amyloid A protein

SAIDs Systemic Autoinflammatory Diseases

SAP Serum Amyloid P component

SD Standard Deviation

TNF Tumour Necrosis Factor

TRAPS TNF Associated Periodic Syndrome

TSH Thyroid Stimulating Hormone

TTR Transthyretin

TNF Tumour Necrosis Factor

UCL University College London

## **Chapter One:**

### **Introduction**

## **An introduction to amyloidosis**

Amyloidosis is a disorder of protein misfolding whereby insoluble amyloid fibrils are formed from precursor proteins and accumulate in the extracellular space leading to organ dysfunction[1]. Over 30 different proteins are now known to form amyloid fibrils *in vivo*[2]. Although these unrelated precursor proteins all share a pathognomonic structure as amyloid fibrils, they are associated with clinically distinct disease phenotypes requiring very different treatment modalities.

The highly characteristic core amyloid fibril structure, the  $\beta$ -pleated sheet conformation, is composed of anti-parallel strands of polypeptide chains perpendicular to the fibrils in which the N- and C-terminals are oriented in opposite directions[3]. This structure is associated with a number of specific properties; (i) it consists of fibrils of ~7-10nm diameter, straight and unbranching seen under electron microscopy[4], (ii) they bind to Congo red in an organised manner that produces green birefringence when viewed under cross-polarised light[5] (Figure 1.1), (iii) the presence of serum amyloid P (SAP) protein bound in a reversible calcium-dependent manner to all amyloid fibrils[6], and (iv) the presence of other non-fibrillary constituents; glycosaminoglycans (GAGs), heparan sulphate, apolipoprotein E, collagen (type IV), laminin and dermatan sulphate[7].

## **Amyloid precursor proteins and fibril formation**

The processes responsible for fibril formation are not yet fully understood and are clearly variable depending on amyloid type. Amyloid is known to develop in several distinct circumstances;

- (i) The production of inherently amyloidogenic proteins by either mutation or malignant production, for example in the most commonly diagnosed form of systemic amyloidosis AL amyloidosis, amyloid fibrils are formed from the monoclonal production of inherently amyloidogenic immunoglobulin light chains[8]. Similarly, in hereditary amyloidosis, variant proteins are formed that are inherently

amyloidogenic and more readily form fibrils than the wild-type protein[9].

- (ii) The production of amyloid by physiological proteins at physiological concentrations over time. The prototypic amyloid which forms in this way is wild-type transthyretin amyloidosis (ATTR). Formerly known as senile systemic amyloidosis, ATTRwt is an increasingly recognised form of amyloidosis that is now the second most diagnosed form in the U.K.[10]. TTR amyloid is formed from the wild-type transthyretin protein at physiological concentrations in the blood over time. A novel mechano-enzymatic process has been identified and this may explain how a normal plasma protein, with no increase in concentration, can form amyloid over time [11]. This is explored in detail in Chapters 3 and 4.
- (iii) A sustained increased concentration of the precursor protein. An important example of this is AA amyloidosis, the rare but serious complication of chronic inflammation of multiple aetiologies. In AA amyloidosis raised levels of the acute phase reactant serum amyloid A protein (SAA) overtime leads to the formation of amyloid[12]. The pathogenesis of AA amyloidosis is discussed in detail in Chapter Five.

There are some forms of amyloidosis, such as the recently described ALect2, where the mechanism of amyloid formation remains entirely unclear although it is now the third most commonly diagnosed form of renal amyloidosis[13]. It also remains unknown why and how the different forms of amyloidosis display tropism for certain tissue types, for example cardiac or renal tissue, and why only small percentages of patients with plasma cell dyscrasia or chronic inflammation go on to develop amyloidosis.

Table 1 shows the characteristics of the most common forms of amyloidosis, their precursor protein, tissue tropism, and treatment strategies.

**Figure 1.1: Characteristic Congo red binding and green birefringence of amyloid when viewed under cross-polarised light microscopy**

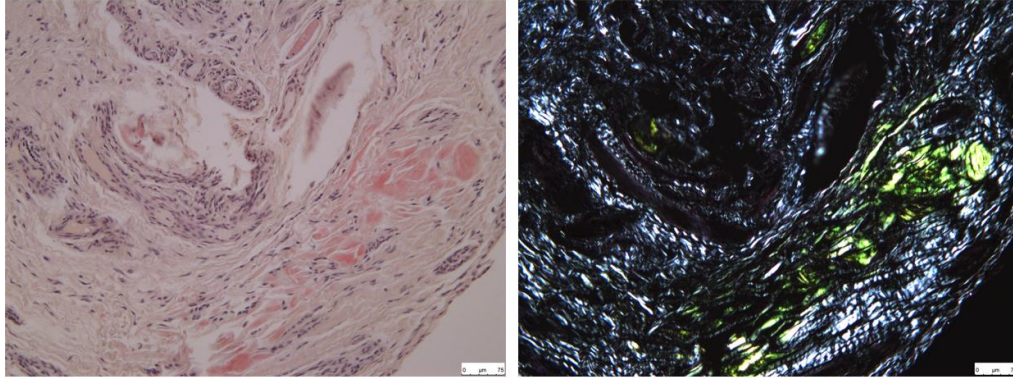

Tissue biopsy demonstrating Congo red binding (A) and apple green birefringence under cross-polarised light (B), the gold standard for the diagnosis of amyloid.

**Table 1.1: Common forms of systemic amyloidosis, their precursor proteins, clinical characteristics and treatment**

Amyloid Type	Precursor Protein	Clinical Characteristics	Treatment	Treatment Target
<b>AA</b>	Serum amyloid A protein	Proteinuric renal failure in those with chronic inflammation	Suppression of inflammation	SAA < 6.4 mg/L
<b>AApoAI</b>	Variant apolipoprotein AI	Early: Proteinuric renal failure Late: Liver and cardiac dysfunction	Liver and or renal transplantation	Preservation of renal function
<b>A<math>\beta</math>2M</b>	$\beta$ 2-microglobulin	Musculoskeletal symptoms in those on long-term haemodialysis	High-flux dialysis Ultrapure dialysate Renal transplantation	Prevention
<b>AFib</b>	Variant fibrinogen A alpha chain	Renal Failure	Supportive Care Organ Transplantation	Preservation of renal function
<b>AGel</b>	Variant gelsolin	Corneal lattice dystrophy Cranial neuropathy Renal amyloid	Supportive Care Facial surgery	Cosmetic
<b>AL</b>	Monoclonal immunoglobulin light chain	Peri-orbital purpura, macroglossia, renal Failure, cardiac failure, hypotension, autonomic dysfunction,	ASCT Chemotherapy Supportive Care	dFLC < 40mg/L
<b>ALect2</b>	Lect2	Renal and hepatic dysfunction	Supportive care	Preservation of renal function
<b>ALys</b>	Variant lysozyme	Sicca and Gastrointestinal symptoms Renal failure	Supportive Care Orthotopic liver transplant Renal transplant	Optimisation of renal function
<b>ATTRm</b>	Variant transthyretin	<b>Familial Amyloid Polyneuropathy</b> Neurological and cardiac dysfunction <b>Familial Amyloid Cardiomyopathy</b> Primarily cardiac diastolic dysfunction	Liver transplantation if young <b>Newly licenced treatments:</b> TTR stabilisers Small interfering RNA Antisense oligonucleotides	Stabilisation of neurological and cardiac dysfunction
<b>ATTRwt</b>	Transthyretin	Cardiac amyloidosis in the elderly History of carpal tunnel syndrome, spinal stenosis, tendon rupture	Supportive care <b>Newly licenced treatments:</b> TTR stabilisers Small interfering RNA	Stabilisation of cardiac dysfunction

**SAA= serum amyloid A proten. dFLC = difference between involved and uninvolved free light chains**

## **Pathogenesis**

Once formed in the cytoplasm amyloid fibrils aggregate in the extracellular space leading to organ dysfunction, probably due to mechanical disruption of normal tissue architecture[14]. *In vivo* amyloid fibrils are known to act as a nidus for further amyloid deposition, a phenomenon demonstrated elegantly in mice models of AA amyloidosis[15]. In this study, mice who typically developed AA amyloidosis after 25 days of persistent inflammatory challenge, rapidly accumulated amyloid through the administration of a small amount of pre-formed amyloid extract. This nidus-like activity is referred to as amyloid enhancing factor and is also demonstrated in humans, where the rapid re-accumulation of amyloid is seen following inflammatory stimuli (such as a chest infection) in patients whom have previously regressed their amyloid deposits[16].

The non-fibrillar amyloid components, such as SAP and glycosaminoglycans, act as a scaffold for polymerisation and confer a resistance to degradation[17]. However, if the production of the precursor protein is reduced or removed, regression of amyloid can be seen. This can be demonstrated clinically with the improvement of organ function following treatment of systemic amyloidosis; organ response. This process can also be visualised using amyloid-specific imaging techniques which will be described later in this chapter. The process of regression involves a complement-dependent, macrophage-derived giant cell reaction that remains to be fully elucidated[18].



## **Epidemiology of amyloidosis**

Few epidemiological data have been published on amyloidosis and it is widely considered to be a rare but also an under diagnosed condition, so prevalence data are likely to be underestimates. The most commonly diagnosed form of systemic amyloidosis is light-chain (AL) amyloidosis. A recent study from Olmstead County, USA, revealed an incidence rate for AL amyloidosis from 1990-1999, 2000-2009, and 2010-2015 of 1.1, 0.9, and 1.6 per 100,000 person-years, respectively[19]. A review of both referrals to the NAC and death certificates from across the UK suggests that amyloidosis in the UK has a similar incidence of one per 100,000 population and is the cause of death in 0.58 per 1000 individuals [20]. Figure 1.2 shows the cases of amyloidosis seen at the NAC from 1987 to 2012. In total 5,100 new patients were seen over this time period and over time the patterns of referrals have changed[21]. This is explored in detail in Chapter Five. AL amyloidosis is the most commonly diagnosed form of amyloidosis at the NAC and has remained so over the past 27 years. In contrast there has been a large increase cases of ATTRwt, almost certainly due to the increasing use of cardiac MRI imaging in those with heart failure symptoms as well as increasing awareness of the disease. This is further explored in Chapters 3 and 4.

Data regarding the prevalence of the hereditary amyloidoses is also lacking but has been estimated in populations where clusters of variants are well described. The most common amyloid mutation worldwide is the V30M TTR variant which has a prevalence as high as 1 in 538 in northern Portugal[22]. In County Donegal, Ireland, the T60A TTR variant has a population prevalence of 1.1%[23]. These two mutations cause the disease familial amyloid polyneuropathy (FAP) a form of ATTRm that appears to be rare in the UK. A US study of 3856 African American participants enrolled on the Atherosclerosis Risk in Communities study found the familial amyloid cardiomyopathy (FAC) variant V122I TTR was present in as much as 3%, but only 7% of these individuals actually had evidence of cardiac amyloidosis[24]. In a review of 4459 referrals to the NAC TTR variants were found in 17%; the most prevalent were the V122I (42%), T60A (25%), and V30M (16%)

described above[9]. The incidence of AA amyloidosis is difficult to estimate as it is known to be highly variable between countries due to the underlying inflammatory conditions that cause it and the local availability of treatment for these conditions[25].

**Figure 1.2: Cases of amyloidosis referred to NAC over 25 years**

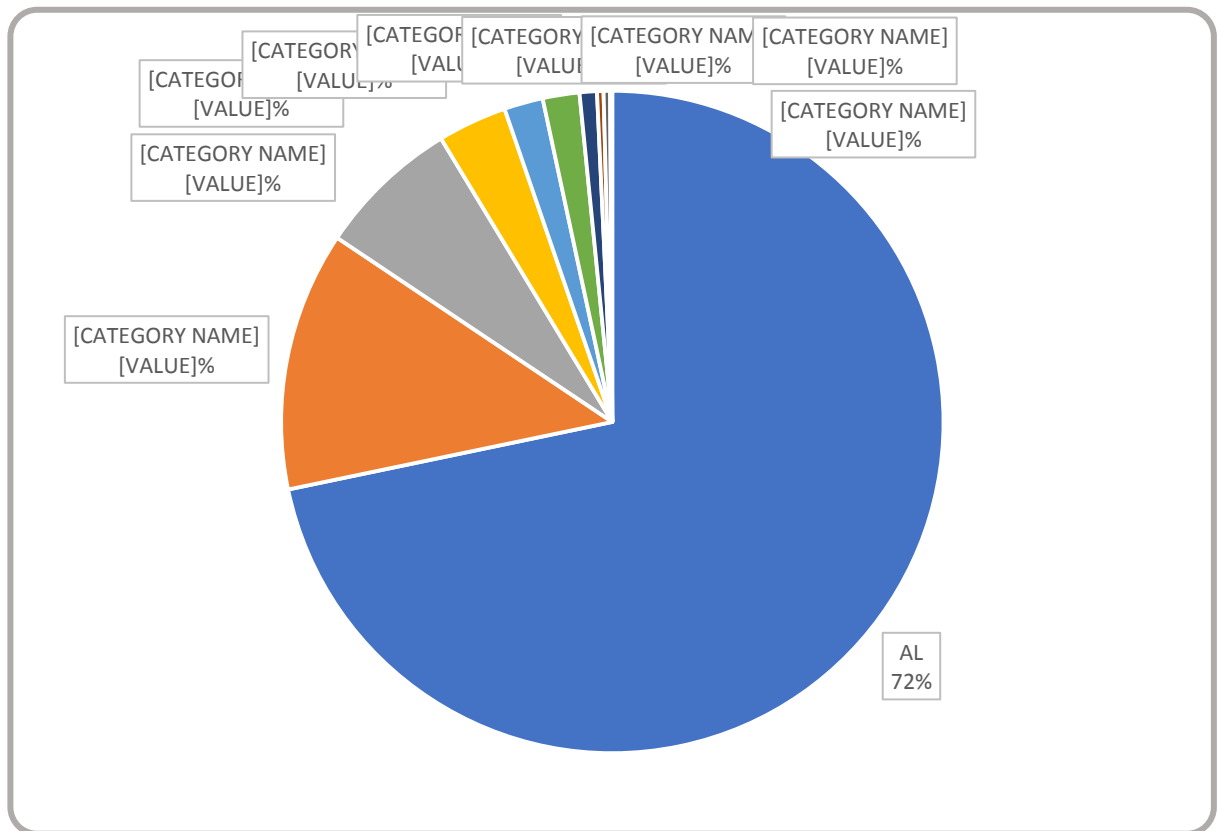

This diagram is derived from data published by the NAC[21]. Abbreviations of amyloid types have been defined earlier in this chapter. AL amyloidosis is the most commonly diagnosed form of amyloidosis, AA amyloidosis is the second most prevalent, and ATTR amyloidosis both wild type and variant forms are third.

## **Diagnosis and Assessment of Amyloidosis**

The clinical manifestations and natural history vary greatly between, and even within, amyloid fibril types and the treatment differs widely. This necessitates an applied protocolised approach to the assessment of any patient referred with tissue proven or suspected amyloidosis.

The NAC has a standardised diagnostic approach to the patient with suspected amyloidosis which is outlined in figure 1.3. Patients are referred to the NAC typically on the basis of a tissue biopsy showing amyloid or cardiac imaging suggestive of a cardiac amyloidosis. Clinicians in any hospital suspecting systemic amyloidosis can follow a similar diagnostic approach, however, currently the NAC is the only centre in the UK to offer Serum Amyloid P scintigraphy and experience in its interpretation.

## **Symptoms and clinical signs of amyloidosis**

Due to the multisystem nature of systemic amyloidosis presentation is highly variable and as such diagnostic delay is the norm, with patients presenting late with advanced disease[21]. It is widely acknowledged that available treatment is likely to be more efficacious if instigated earlier in the disease course. As such, raising awareness of the amyloidoses and exploring new diagnostic modalities is of crucial importance and the focus of some of this thesis. Some important clinical signs of systemic amyloidosis are also outlined in figure 1.3.

Clinical history, symptoms and signs are dependent on the precursor fibril type and are described in detail below.

## **Histology**

Histopathological diagnosis of amyloid is the gold standard for diagnosis. Identification of Congo red binding with characteristic birefringence under polarized light microscopy is diagnostic of extracellular amyloid fibrils [5]. Following this, the identification of the amyloid precursor protein is crucial as this determines

prognosis and treatment options. Immunohistochemistry is used to type amyloid fibrils and can differentiate TTR amyloid from other precursor proteins such as immunoglobulin light chains (AL Amyloid) and serum amyloid A (SAA) protein with a high degree of accuracy [26, 27].

Analysis for amyloid is standard for some histopathological specimens such as renal biopsy tissue and bone marrow trephine but it may not be considered in some tissue types unless specifically requested by the clinician, and this is likely to be a cause of diagnostic delay and uncertainty in non-specialist centres. It is standard practice at the NAC to request the histological specimens in which amyloid has been identified from the referring centre and any other tissue specimens available from the referred patient. There is a considerable false positive and false negative rate and availability of cross polarised light microscopy is not universal in UK histopathology laboratories. The NAC runs an annual national course to develop local expertise in the tissue diagnosis of amyloidosis.

If a biopsy has not been taken at the referring centre then, where possible, a biopsy is arranged of the affected organ at the NAC. If this is not possible then biopsy of the abdominal fat pad is an established technique to identify systemic amyloid deposition. In analysis of 600 consecutive patients seen at the NAC with suspected cardiac amyloidosis, the diagnostic sensitivity of fat biopsy was assessed[28]. 216 AL amyloidosis, 113 hereditary transthyretin (ATTRm), and 271 wild-type transthyretin (ATTRwt) amyloidosis were identified. Amyloid was detected by Congo red binding in 84% patients with cardiac AL amyloidosis, 45% of patients with ATTRm and 15% cases with ATTRwt. The absence of amyloid on fat biopsy doesn't exclude the diagnosis of amyloidosis. Bone marrow aspirate and trephine biopsy are recommended in all cases where there is suspect amyloidosis and a plasma cell dyscrasia has been identified[29].

**Figure 1.3: Schedule of clinical assessment and investigations at the UK National Amyloidosis Centre**

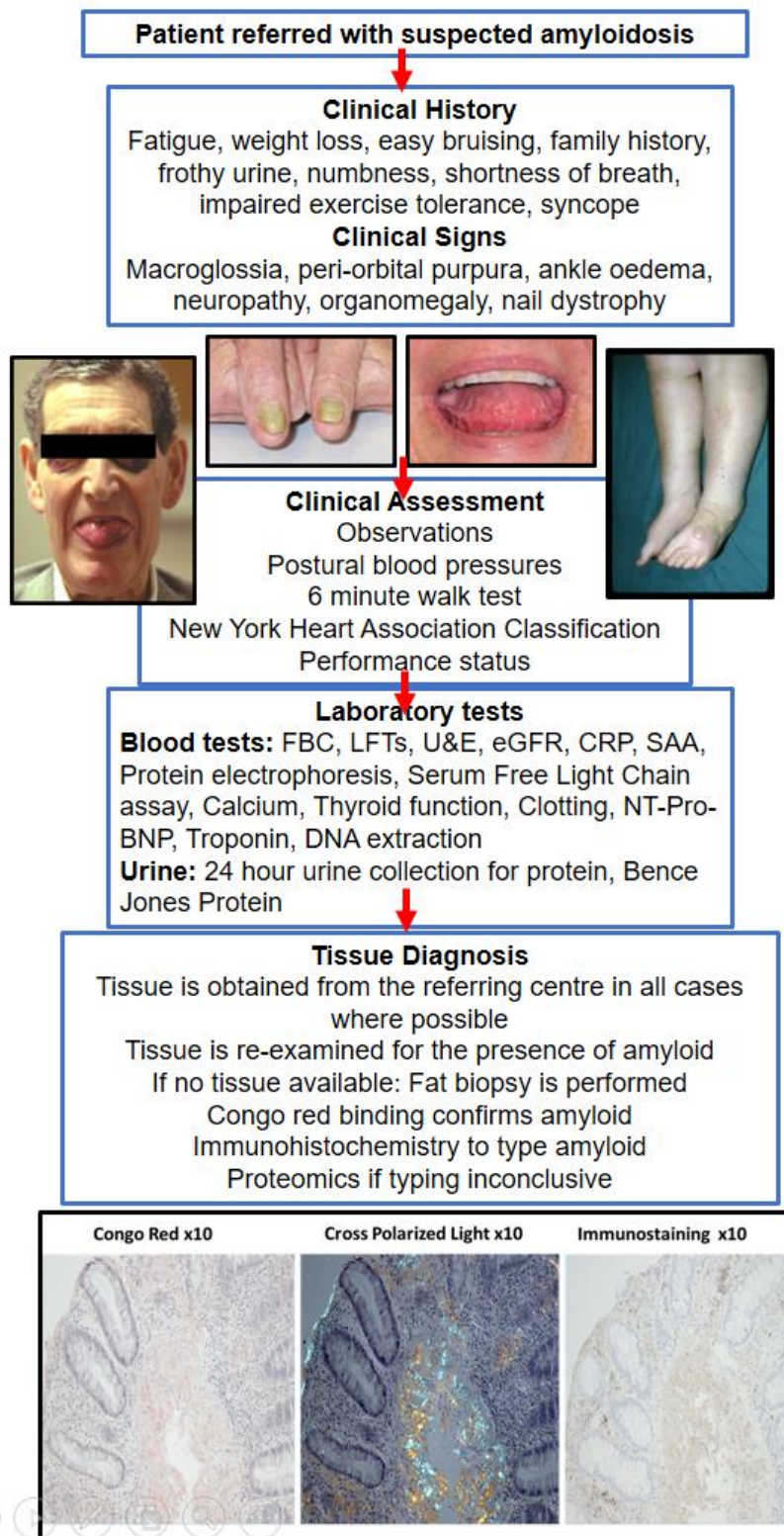

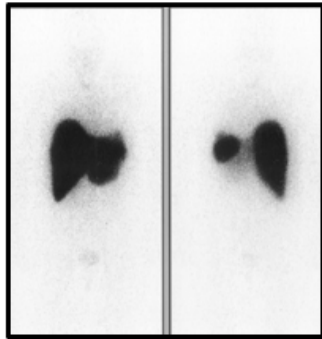

**123I SAP scintigraphy**  
Identifies amyloid deposition in liver, spleen, kidneys, bones and adrenals

SAP scintigraphy (left) shows large amyloid load in liver and spleen from anterior (left) and posterior (right) views, obscuring the kidneys and adrenals

SAP scintigraphy is used to identify visceral amyloidosis in AL and the hereditary amyloidoses



Image left: TcDPD diagnoses TTR cardiac amyloidosis with Sensitivity: 91% Specificity: 82%

Image shows grade III cardiac uptake

**99mTcDPD Scintigraphy**  
Identifies cardiac amyloidosis of TTR type

Serum cardiac biomarkers NT-ProBNP and Troponin are used with cardiac imaging to make a diagnosis of cardiac amyloidosis



**ECG**  
Typical features: Low voltage, pseudo-infarct pattern, atrial arrhythmias

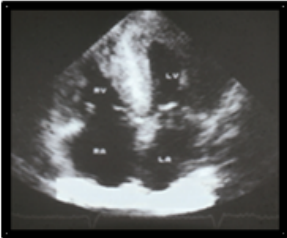

**Echocardiogram**  
Typical features:  
Ventricular hypertrophy  
Preserved ejection fraction  
Impaired global strain rate  
Apical sparing strain pattern  
Interventricular wall > 12mm

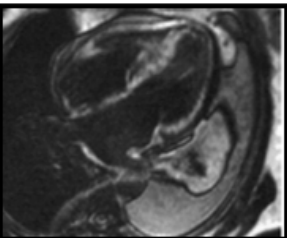

**Cardiac MRI**  
Late gadolinium enhancement (global subendocardial pattern)  
Elevated extracellular volume  
Elevated native T<sub>1</sub>

## **Proteomics**

In up to 25% cases where amyloid has been identified by Congo red binding, immunohistochemistry is unable to identify the amyloid type. This represents a significant diagnostic and therefore treatment challenge [30]. The technique of laser microdissection and mass spectrometry (LDMS) can identify proteins from formalin-fixed paraffin-embedded tissues. In 142 consecutive biopsy specimens from the NAC there was 100% concordance between immunohistochemistry and LDMS[30]. A further study from the NAC demonstrated that LDMS is superior to immunohistochemistry for confirming amyloid type[31].

## **Gene Sequencing**

Genetic testing is often necessary to determine the final diagnosis. If cardiac amyloid is identified, then TTR gene sequencing is invariably requested but often it is the amyloid tissue typing result which guides the genetic testing requests. Given the variable penetrance of many of the amyloid genes, genetic counselling can be challenging. Those with a family history of hereditary amyloidosis who are asymptomatic should be counselled before testing is considered[32].

## **Amyloid Specific Imaging**

Whilst histology remains the gold standard technique for the diagnosis of amyloidosis, a number of amyloid-specific imaging techniques have been developed. These techniques are used alongside tissue diagnosis to determine the extent of the disease and they can also be used reliably to make the diagnosis of amyloidosis when tissue is not readily available, or biopsy is contraindicated. They are also able to assess response to treatment and are used serially at the NAC to inform treatment decisions.

### **<sup>123</sup>Iodine Serum Amyloid P Scintigraphy**

SAP is a component of all amyloid deposits and when it is radiolabelled with <sup>123</sup>Iodine and imaging is performed with whole body scintigraphy it is a specific test for identifying amyloid deposits in the viscera [33]. This technique was invented and developed for clinical use at the NAC [34]. To date over 10,000 SAP scans have been performed there. This safe and specific test is able to identify and quantify visceral amyloid non-invasively and can also clearly demonstrate regression.

<sup>123</sup>Iodine SAP scintigraphy has revolutionised the understanding of the natural course of amyloidosis, identifying clinically silent amyloid deposits (for example heavy amyloid deposition in the spleen) and its response to treatment (Figure 1.4). SAP scintigraphy has a low radiation dose and is very safe, but its use is limited by the high cost and availability of purified human SAP and the technique also requires expertise in reporting, thus its use has remained largely confined to the NAC. Importantly it is not able to identify amyloid deposition in the skin, nerves, hollow viscus and, importantly, the heart.



**Figure 1.4:  $^{123}\text{I}$  Iodine Serum Amyloid P Scintigraphy in a patient with AL amyloidosis**

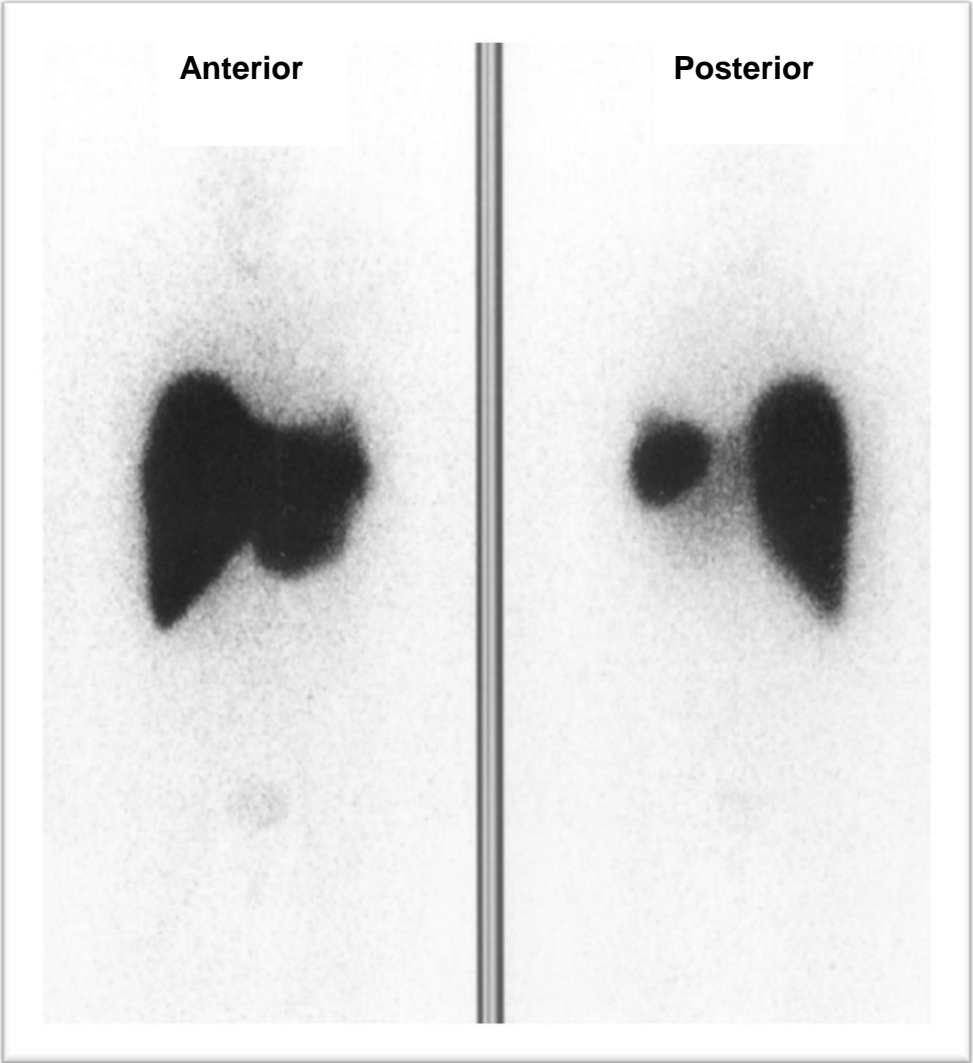

**$^{123}\text{I}$  Iodine SAP scintigraphy demonstrating heavy amyloid load in the liver and spleen overlying and obscuring the kidneys and adrenals; anterior and posterior views.**

## Cardiac Imaging

### <sup>99m</sup>TcTechnetium-DPD Scintigraphy

Nuclear medicine physicians have long reported the incidental finding of cardiac uptake on whole body bone scintigraphy and postulated that it may be due to cardiac amyloidosis[35]. In the early 1980's this phenomenon was formerly investigated with the bone tracer *technetium* Tc 99m 1,1-diphosphonopropane-2,3-dicarboxylic acid (<sup>99m</sup>TcTechnetium-DPD Scintigraphy), but studies failed to support its routine use as a diagnostic test due to apparent low sensitivity[36]. However, its utility had mostly been assessed in cases of suspected cardiac AL amyloidosis. In fact, when this imaging modality was revisited it was found that <sup>99m</sup>Tc-DPD Scintigraphy was highly sensitive and specific for cardiac TTR amyloidosis, in both wild-type and variant forms[37]. In this seminal paper by Perugini and colleagues the reported sensitivity and specificity was 100% respectively, but it is now known that low-grade tracer uptake can be seen in up to a third of cases of cardiac AL amyloidosis[38]. The exact mechanism of uptake remains elusive and even the analysis of post mortem specimens from patients with known cardiac uptake have not been revealing. Whatever the mechanism, <sup>99m</sup>TcTechnetium-DPD scintigraphy is a cheap, safe and highly effective tool for the diagnosis of cardiac amyloidosis and is even able to identify clinically silent ATTRwt in those with a normal echocardiogram[39]. This imaging tool is now being used routinely to diagnose ATTR amyloidosis, largely abrogating the need for endomyocardial biopsy[40]. The Perugini grading system for the diagnosis of ATTR cardiac amyloidosis is described in detail in Chapter 3.

### **Cardiac Magnetic Resonance Imaging**

Over the past 15 years cardiovascular magnetic resonance (CMR) has been established as an important tool in the diagnosis of cardiac amyloidosis[41]. Its use by general cardiologists in investigation of heart failure and valvular disease has undoubtedly led to the huge increase in cases of cardiac amyloidosis that has been seen in the developed world.

After the administration of contrast, an amyloid characteristic pattern of global subendocardial late gadolinium enhancement (LGE) is seen, coupled with abnormal myocardial and blood-pool gadolinium kinetics. This approach is able to reliably delineate cardiac amyloid from hypertrophic cardiomyopathies[42] and transmural patterns of LGE are able to reliably and accurately distinguish ATTR from AL cardiac amyloidosis[43]. Additionally, the technique of T1 mapping can identify patients with histologically-proven cardiac amyloidosis and is a strong predictor of mortality in AL amyloidosis[44].

Repeated CMR can also track the continuum of amyloid accumulation using LGE patterns, demonstrating how amyloid infiltration leads to cardiac dysfunction[45]. However, concerns over repeat gadolinium administration may limit the use of LGE as a disease biomarker[46]. CMR has also demonstrated regression of amyloid within the heart, a phenomenon previously thought not to occur to any significant degree[47].

### **Echocardiography**

Echocardiography was classically the gold-standard technique to identify cardiac amyloidosis and remains an important tool in the diagnosis as it is the most widely used non-invasive test in patients with heart failure symptoms.

In the advanced stages of cardiac amyloidosis, the characteristic features of cardiac amyloidosis are readily identified and pathognomonic; biatrial

enlargement, atrial septal thickening, interventricular septal thickening, severe impairment of diastolic function with preserved systolic function and severe impairment at the LV base with apical sparing and impaired global strain[48]. However, in early disease, even in the face of cardiac symptoms, the echocardiographic appearances can be mistaken for those of classical heart failure and thus other imaging modalities including CMR and <sup>99m</sup>Tc-DPD are better in this context. This poses a diagnostic challenge for echo-cardiologists and echo-technicians working in non-specialist centres who must retain clinical suspicion for cardiac amyloidosis[49].

### **Amyloid subtypes**

The clinical consequences of amyloid deposition are diverse, ranging from localised deposits with little clinical morbidity to rapidly progressive multisystem diseases with high mortality.

### **Localised Amyloid**

Localised amyloid deposition is a consequence of production of precursor protein[50]. At the NAC, 98% of localised amyloid deposits are of the AL type, in keeping with the experience in other centres throughout the world[51]. The monoclonal immunoglobulin light chains are produced by a discrete foci of clonal plasma cells and only rarely transform to systemic amyloidosis[51]. Whilst this condition is rare the common sites for deposition are the skin, trachea and respiratory tract, urogenital tract and the orbits. Resection of the amyloid can be curative, but recurrence is common and these patients are typically followed-up lifelong to ensure no transformation to systemic disease[52].

Insulin amyloid is a form of localised amyloid found at insulin injection sites. Biopsies of these areas show amyloid that stains with antibodies to insulin[53].

### **Systemic Amyloidosis**

The systemic amyloidoses are a heterogeneous group with a wide range of mortality and morbidity. They can be rapidly progressive and fatal or slowly progressive with near normal life expectancy. As such it is crucial to identify the underlying amyloid precursor protein and to systematically assess for organ involvement, so that where treatment is available it can be instigated as early in the disease course as possible. Diagnostic delay is the norm and impacts on survival.

## **AL Amyloidosis**

Systemic AL amyloidosis is the most commonly diagnosed of the amyloidosis and all patients undergoing investigation for suspected amyloidosis should be investigated for an underlying clonal disorder[29]. AL amyloidosis occurs as a consequence of a plasma cell dyscrasia whereby the variable domains of inherently amyloidogenic monoclonal immunoglobulin light chains form amyloid deposits in a myriad of tissues. Most commonly the amyloid is formed from  $\lambda$  light chains, and rarely heavy chains or a combination of heavy and light chains[54]. Myeloma is unusual, and the plasma cell fraction seen is usually similar to that commonly associated with MGUS[55]. The vast majority of patients have detectable clones identified by a combination of serum and urine electrophoresis and immunofixation and the serum free light chain (FLC) assay (see methods). The FLC assay is also used to assess treatment response and has revolutionised the assessment of AL amyloidosis. Bone marrow examination and skeletal survey are performed to exclude multiple myeloma.

Referral to the NAC is invariably via renal biopsy and over 60% of cases involve the kidneys presenting with proteinuria[56]. Clinical features of periorbital purpura and macroglossia are considered pathognomonic of AL amyloidosis, but the diagnosis of AL amyloidosis is often delayed due to the highly variable nature of its presentation [21]. The disease may involve all vital organs, except the brain: cardiac amyloidosis presenting with heart failure and preserved ejection fraction, renal amyloidosis with proteinuria, soft tissue amyloid infiltration (carpal tunnel syndrome, macroglossia), hepatic amyloidosis, peripheral or autonomic amyloid (which can cause debilitating postural hypotension and diarrhoea), and gastrointestinal amyloidosis[57].

The most feared complication is cardiac amyloidosis, which substantially alters prognosis and limits treatment options. Cardiac troponin-T and NT-proBNP form the basis of the Mayo Clinic 2004 cardiac AL staging system with stage I (NT-proBNP <332 ng/L and troponin-T <0.035  $\mu$ g/L), stage II (NT-proBNP >332 ng/L or troponin-T >0.035  $\mu$ g/L) and stage III (NT-proBNP >332 ng/L and troponin-T >0.035  $\mu$ g/L [58].

Treatment is by chemotherapy or autologous stem cell transplant (ASCT) or a combination of both. Suppressing the clonal B cells reduces the production of the amyloid fibril precursor protein (haematological response). This may facilitate gradual regression of amyloid deposits and preservation or improvement in organ function (organ response). The more complete the clonal response the longer the interval of treatment free survival[21]. This allows the greatest time for improvement in organ function and regression of amyloid. It is also apparent that pre-fibrillar light chain aggregates are directly toxic to tissues particularly in the heart, a phenomenon that can be seen following chemotherapy with improvement in cardiac function without evidence of amyloid regression[59].

Chemotherapy regimens are based on those for multiple myeloma. High-dose steroids with the alkylating agents cyclophosphamide or melphalan are still used, now in combination with immunomodulatory treatments such as thalidomide or the second line agent lenalidomide[59]. However, it is the proteasome inhibitors that have revolutionised treatment in AL amyloidosis with high response rates and good tolerance. At the NAC bortezomib combinations (usually with dexamethasone and cyclophosphamide) are used front-line in AL amyloidosis.

Previously those with advanced cardiac amyloidosis were not eligible for ASCT. However, the advances in chemotherapeutic regimens have led to haematological and organ responses, such that deferred ASCT has now been reported with favourable outcomes[60]. This is important as ASCT presents the best opportunity for durable haematological and organ response.

Data from the NAC has recently shown that a rapid haematologic response within the first month of treatment in this group substantially improves survival to 38 months for those with complete haematological response, 7 months for partial response and 2.6 months for non-responders[61]. We have now also demonstrated that a rapid haematological response is strongly linked to renal survival amongst those with end-stage renal disease[56].

## **Transthyretin Amyloidosis**

Transthyretin amyloidosis (ATTR) is caused by a deposition of fibrils, derived from either wild-type (ATTRwt) or variant transthyretin (ATTRm). Transthyretin (TTR) is a transporter protein for retinol and thyroid hormones, it is synthesized primarily in the liver. The TTR gene is located on chromosome 18 and is highly polymorphic with 130 amyloidogenic variants, most of which are nucleotide substitutions, already described[9].

ATTRwt manifests itself primarily as diastolic heart failure and as discussed above, it is caused by a novel mechano-enzymatic process at physiological concentrations of TTR in the blood. ATTRm has a more variable phenotype which broadly fits into two categories; FAP and FAC. Familial amyloid polyneuropathy (FAP), in which amyloid deposits and disrupts peripheral nerves, the heart, the vitreous, the gastrointestinal tract and the lungs. In familial amyloid cardiomyopathy (FAC), amyloid accumulates predominantly in the heart causing diastolic heart failure very similar to ATTRwt[62].

The repurposed bone scintographic tracer, technetium ( $^{99m}\text{Tc}$ ) Tc-3,3-diphosphono-1,2-propanodicarboxylic acid ( $^{99m}\text{Tc}$ -DPD), is highly sensitive and specific for even clinically silent ATTR amyloidosis within the heart, and is now being used routinely to diagnose ATTRwt amyloidosis [40]. The  $^{99m}\text{Tc}$ -DPD scan largely abrogates the need for endomyocardial biopsy and allows for the detection of amyloid within the myocardium, even in those without symptoms or echocardiographic signs. This presents an opportunity to diagnose this condition at a much earlier stage, which is of pressing importance given the recent licencing of several new agents for the treatment of both ATTRm and ATTRwt[63-65]. This is the focus of Chapters 3 and 4.



### **β2-microglobulin Amyloidosis**

Dialysis-related amyloidosis is a serious complication of long-term dialysis therapy. In 1985 the precursor protein was identified as β2-microglobulin (β2M), an 11.8 kDa polypeptide that forms the nonvariable chain of MHC class I present on the surface of all nucleated cells and exclusively renally cleared[66]. Thus, as the glomerular filtration rate declines, circulating levels of β2M rise. The formation of amyloid requires persistently high plasma concentrations of β2M over time, similar to the mechanism of AA amyloidosis and presents further evidence that non-truncated wild-type proteins can form amyloid.

This form of amyloidosis typically arises after 5 years of dialysis and has a tropism for the musculoskeletal system, presenting with arthralgia which leads to significant morbidity due to pain and deformity, and visceral deposition may also occur[67]. Interestingly in 2012, a variant of β2M was discovered in a French family with multi-visceral amyloid deposition without musculoskeletal symptoms[68]. The change to high-flux biocompatible dialysis membranes and ultrapure dialysate may reduce the incidence of this condition, as will the more widespread use of transplantation to avoid many years on dialysis.

### **ApoAI Amyloidosis**

Apolipoprotein AI (ApoAI) amyloidosis is characterized by the deposition of ApoAI as amyloid. ApoAI is the main protein component of high-density lipoproteins with a function in cholesterol transport and it is synthesised in the liver and small intestine [69].

The ApoAI gene is encoded on *chromosome* 11q23-q24 and the protein is inherently amyloidogenic, forming amyloid in both the wild-type and variant forms which demonstrate autosomal dominant inheritance. The wild-type form is found in the aortic intima of older patients[70] and in knee joint menisci[71]. It is not associated with significant visceral pathology. In contrast renal involvement is common in hereditary ApoAI amyloidosis and to date 20 amyloidogenic mutations have been reported with a variable age of onset (second to sixth decade) and

highly variable penetrance [72]. Diagnosis is usually following renal biopsy for proteinuric renal failure, and hepatosplenomegaly and cardiomyopathy are late features. Progression of the disease is slow, and renal transplantation results in prolonged graft survival even if there is histological or SAP scintigraphic evidence of recurrent amyloid deposition[73]. However, liver transplantation to reduce the concentration of variant ApoA1 protein has been shown to result in regression of amyloid and is preferable to renal transplantation because it may also prevent cardiac amyloidosis[73]. It should be noted that mutations in the ApoAII gene are also associated with systemic amyloidosis, exhibiting with predominantly renal involvement and with a similar slow decline to end stage renal failure[74].

### **ALect 2 Amyloidosis**

Leucocyte chemotactic factor 2 (ALECT2) amyloidosis presents with low grade proteinuric renal impairment and is associated with a slow decline in renal function[75]. It was first described in 2008 in a 61-year-old woman with nephrotic syndrome[76]. Since then, a retrospective analysis of renal biopsies has shown that ALECT2 amyloid as the third most common type of renal amyloid in the USA[77]. Despite its prevalence, the mechanism by which this chemotactic and growth factor forms amyloid remains unknown. No gene mutation has been identified but several studies including that from the NAC show that almost all affected individuals are homozygous for the G allele that results in a substitution of isoleucine with valine at position 40, a polymorphism found at a frequency range of 0.6–0.7 in those of European ancestry[13]. Like SAA, LECT2 concentrations in the blood increase as part of the acute phase response and amyloid may result in those with the G/G genotype and chronic inflammation [78].

24 patients with ALect2 on renal biopsy have been reviewed at the NAC[13]. SAP scintigraphy at diagnosis showed that in addition to renal amyloid, 88% had splenic and 46% had hepatic amyloid. Serial SAP scans up to a decade apart, showed no progression of amyloidosis. No patients developed cardiac amyloidosis. Median

estimated patient survival from diagnosis was more than 15 years. Treatment is supportive.

### **Hereditary Fibrinogen Amyloidosis**

Hereditary fibrinogen amyloidosis (AFib) is caused by a number of autosomal dominant mutations in the fibrinogen A $\alpha$ -chain gene and is the most common cause of hereditary renal amyloidosis in the United Kingdom[79]. It was first described in a Peruvian kindred in 1993[80]. Patients present with proteinuric renal impairment and typically progress to end-stage renal failure. Characteristically the histological findings demonstrate massive glomerular amyloid infiltration and little or no vascular or interstitial deposits.

In a series of 71 patients with AFib from the NAC, median age at presentation was 58 yr (range 33 to 83 yr) and progression to end stage renal disease from diagnosis was within 5 years[79]. 63 of these individuals underwent SAP scintigraphy which showed renal involvement in all (except those who had already reached end-stage renal failure whereby the scan is not diagnostic), splenic amyloid in 89% and adrenal amyloid in 21%. No patient was considered to have cardiac involvement, although cardiac amyloidosis is described. Renal transplantation is associated with a high recurrence rate in the graft and as such liver transplantation to prevent renal failure and cardiac amyloidosis is often considered, particularly if the patient is young with no co-morbidities at diagnosis[81].

### **Gelsolin Amyloidosis**

Gelsolin amyloidosis (AGel) is an autosomal dominant hereditary form of amyloidosis whereby amyloid is formed from cleavage fragments of variant gelsolin, an actin modulating protein encoded by the GSN gene on 9q33.2[82]. The condition presents in the third decade of life with corneal lattice dystrophy and as such was first described in 1969 by an ophthalmologist from Finland where it remains most prevalent and is often referred to as Finnish-type amyloidosis[83].

AGel is also associated with cutis laxa and slowly progressive bilateral cranial neuropathy[84]. SAP scintigraphy can identify renal amyloid when clinically silent at onset. Due to its rarity and likely under diagnosis, it is difficult to estimate mortality but most series suggest life expectancy is normal, although proteinuric renal failure can develop very slowly over time[85].

There is currently no specific treatment available but surgical lifting of the face can prevent the formation of the characteristic dropping appearance caused by bilateral facial nerve palsy.

### **Lysozyme Amyloidosis**

Lysozyme (ALys) amyloidosis is a rare hereditary autosomal dominant amyloidosis caused by mutations in the gene for Lysozyme, a bacteriolytic enzyme present in mucous membrane secretions, polymorphs and macrophages. It was first described in 1993 at the NAC[86]. At presentation sicca symptoms are common due to amyloid deposition in the salivary glands, along with gastrointestinal symptoms and renal failure[87]. A family history is invariably present and hepatic amyloid with spontaneous liver rupture has been frequently reported[88]. In cases with hepatic rupture, or those with a heavy amyloid load by SAP scintigraphy and a family history of rupture, orthotopic liver transplantation has been successfully undertaken, with functioning grafts at up to 11 years post transplantation reported [88]. There is no amyloid specific treatment for this condition and renal transplant also has favourable long-term graft survival outcomes.

### **AA Amyloidosis**

Systemic AA amyloidosis is a serious complication of chronic inflammation caused by accumulation of the acute phase pentraxin protein serum amyloid A (SAA)[89]. SAA is encoded largely by the SAA<sub>1</sub> gene and has a number of polymorphisms[90]. SAA forms amyloid when present in the circulation at supraphysiological levels over time. The UK NAC has the largest known cohort of

individuals with AA amyloidosis [25, 91]. The pathophysiology of AA amyloidosis and the underlying aetiology of the NAC cohort is explored in detail in Chapter 5, Figure 1.5 is a summary of the underlying causes of inflammation in the cohort.

The most common method of presentation is proteinuric renal impairment triggering renal biopsy. Treatment is targeted at the underlying cause of the inflammation, not just for symptomatic relief but also because suppression of SAA levels is associated with stabilisation and even improvement in renal function[25]. An emerging problem is the growing cohort of AA amyloidosis of uncertain aetiology (Idiopathic AA amyloidosis)[91] and this is the focus of Chapter 5 of this thesis. Targeted cytokine inhibition is attractive in this group to suppress the amyloidogenic acute phase response using either interleukin-1[92] or interleukin-6[93] inhibitors to prevent progression to end-stage renal failure.

**Figure 1.5: Cause of underlying inflammation in 659 cases of systemic AA amyloidosis in the NAC cohort**

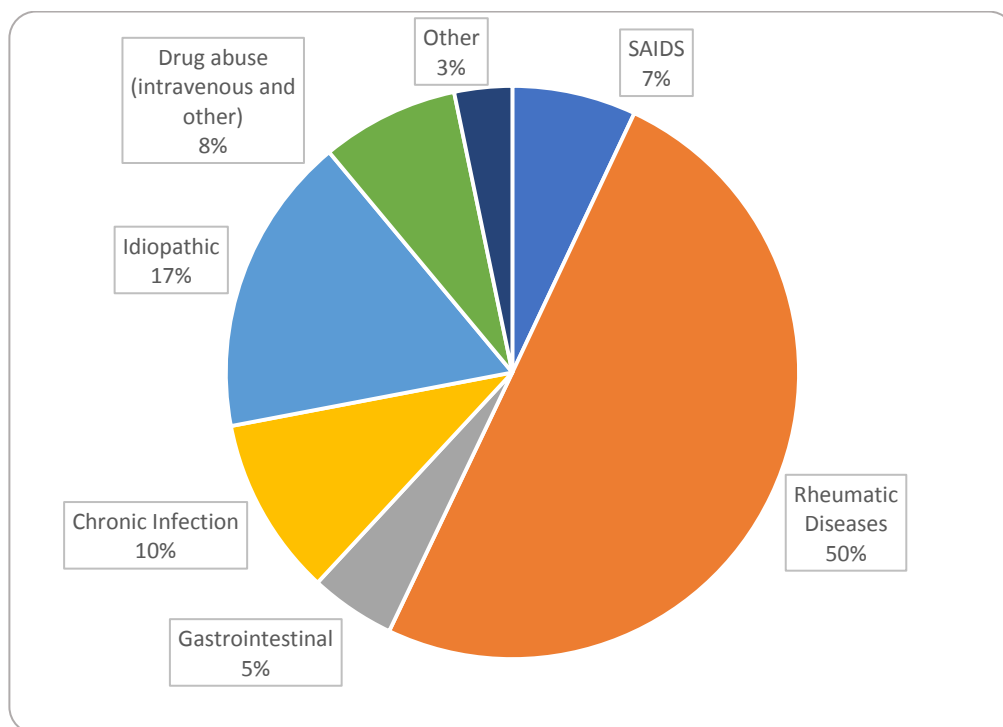

Rheumatic disease predominates with the most common diagnosis rheumatoid arthritis. SAIDS; Systemic autoinflammatory diseases. Other = carcinoma, cyclic

neutropenia, sickle cell anaemia, Castleman's disease, interstitial lung disease, lymphoma.

### **Novel Treatment for Amyloidosis**

This introduction has highlighted the fact that although the systemic amyloidoses are clinically distinct diseases, all amyloid has the same configuration and associated proteins. The association of SAP with amyloid fibrils led to the development of the unique imaging modality of SAP scintigraphy, and SAP has also recently been demonstrated to be a therapeutic target. In a mouse model with large visceral amyloid deposits containing human SAP, the administration of anti-human-SAP antibodies was shown to trigger a rapid clearance of the amyloid from the murine organs with no adverse effects[18]. During the period of study for this thesis a phase I study was conducted on 15 patients with systemic amyloidosis at the NAC. The drug (R)-1-[6-[(R)-2-carboxy-pyrrolidin-1-yl]-6-oxo-hexanoyl]pyrrolidine-2-carboxylic acid (CPHPC) had been identified at the NAC many years earlier and is known to efficiently deplete SAP from the plasma, leaving only SAP in the amyloid deposits[94]. The 15 patients were given CPHPC and then the anti-SAP antibodies. This safely triggered a presumed macrophage and complement reaction leading to the clearance of amyloid deposits mainly from the liver as visualised using SAP scintigraphy[95]. Currently development of this novel treatment approach is on hold.

### **Monogenic Systemic Autoinflammatory diseases**

Systemic autoinflammatory diseases (SAIDs) are disorders of innate immunity classically presenting with a raised acute phase response. Many of these conditions are monogenic and result in lifelong inflammation. As a consequence, there is a high prevalence of AA amyloidosis in those with these rare diseases, and the hereditary periodic fever service grew alongside the amyloidosis service at the NAC over the past 27 years[96].

The autoinflammatory diseases may be rare, but those with monogenic pathology have provided an accelerated insight into the function of the innate immune system and most recently have begun to blur the distinctions between autoimmune, autoinflammatory, and immunodeficiency diseases. Autoimmune diseases have been classically described as disorders of adaptive immune system dysregulation and the autoinflammatory diseases as disorders of innate immunity defined by the absence of pathogenic autoantibodies and autoreactive T cells[97]. However, the ongoing discovery of monogenic defects in innate immune pathways, particularly the monogenic interferonopathies, has led to an evolution of the concept of autoinflammation, suggesting integration between innate and adaptive immunity with mutations in one pathway leading to dysregulation of both systems. Thus, McGonagle and colleagues suggest that inflammatory disorders are viewed as a spectrum, an immunologic disease continuum, with genetic disorders of adaptive and innate immunity at either end[98]. Further, there is increasing acknowledgement that newly described autoinflammatory diseases, such as Deficiency of Adenosine Deaminase 2 (DADA2), are associated with significant immunodeficiency, presenting the opportunity to gain understanding of the mechanisms of not only inflammation, but also of conditions such as pure red cell aplasia and bone marrow failure[99].

Nevertheless, the clinical manifestations of SAIDs are driven by genetically-determined dysregulation of innate immunity, resulting in overproduction of inflammatory cytokines; IL-1 $\beta$ , IL-6, IL-18, TNF, and type I interferon (IFN). As



such, fever is a common presenting symptom and the most frequently diagnosed SAIDs are those associated with periodic fever: Familial Mediterranean fever (FMF); Cryopyrin-associated Autoinflammatory Syndrome (CAPS); Tumour Necrosis Factor Receptor-Associated Periodic Syndrome (TRAPS) and Mevalonate Kinase Deficiency (MKD), which is also known as Hyperimmunoglobulin D Syndrome (HIDS).

Previously thought of as primarily paediatric in presentation, the recognition of adult-onset monogenic autoinflammatory diseases is growing. We conducted a retrospective analysis of adult referrals to the fever service between 2014-2016[100]. 141 new adult patients were seen, 35% had a monogenic disorder: FMF  $n = 21$  [mean age 42 years (range 19–78)]; CAPS  $n = 14$  [mean age 42 years (range 16–79)]; TRAPS  $n = 13$  [mean age 42 years (range 27–76)]; MKD  $n = 1$  (age 36 years); deficiency of the IL-36 receptor antagonist (DITRA),  $n = 1$  (age 59 years).

Over the 20 years since their first description, the monogenic periodic fever syndromes have served to elucidate many mechanisms of inflammation, particularly by their characteristic and profound response to drugs that inhibit interleukin 1 (IL-1), particularly interleukin-1 $\beta$  (IL-1 $\beta$ ) [101, 102]. IL-1 $\beta$  is an important mediator of fever and inflammation and acts through the IL-1 receptor. There is also an endogenous IL-1 receptor antagonist (IL-1Ra) which prevents the binding of IL-1 $\beta$  to its receptor.

The huge advances in genomic techniques have led to the rapid identification of new monogenic inflammatory disorders with at least 30 separate genes now implicated in the autoinflammatory pathways[103]. Additionally, an increasing number of polygenic and/or acquired syndromes are recognised, such as Behçet's and Schnitzler's syndromes, which are unfortunately beyond the scope of this thesis [104].

## **The Pathogenesis of Autoinflammatory Diseases**

The innate immune system is genetically determined to recognise endogenous danger signals through the recognition of damage-associated molecular patterns (DAMPs) and exogenous or pathogen-associated molecular patterns (PAMPs)[105, 106]. The nucleotide binding domain leucine rich repeat pyrin containing 3 protein (NLRP3), also known as cryopyrin, is the most well understood member of the family of nucleotide-binding oligomerisation domain (NOD)-like receptors (NLRs) which, along with Toll-like receptors (TLRs), are the major receptor classes involved in innate immunity. NLRP3 is the major component of the NLRP3 inflammasome, a cytosolic complex comprising NLRP3, the apoptosis-associated speck-like protein (ASC) and caspase 1. The oligomerisation of NLRP3 and ASC results in the cleavage of procaspase-1 to caspase-1[107]. This serves to then cleave inactive pro-IL-1 $\beta$  to form the proinflammatory pleotropic IL-1 $\beta$ . IL-18 release is also stimulated by inflammasome-activated caspase-1 and is an important regulator of immunity.

The binding of IL-1 $\beta$  to the IL-1 receptor induces intracellular signalling and the production of other proinflammatory proteins. An extracellular protein, IL-1 receptor antagonist (IL-1Ra) is an endogenous antagonist of both IL-1 $\alpha$  and IL-1 $\beta$  at the IL-1 receptor[108]. Blockade of the IL-1 receptor or delivery of exogenous IL-1Ra are the therapeutic strategies that have transformed the treatment of those with autoinflammatory diseases[109]. These agents are investigated in detail in this thesis (Chapter 6). The NLRP3 inflammasome is summarised in Figure 1.7.

**Figure 1.6: Actions of interleukin 1 $\beta$**

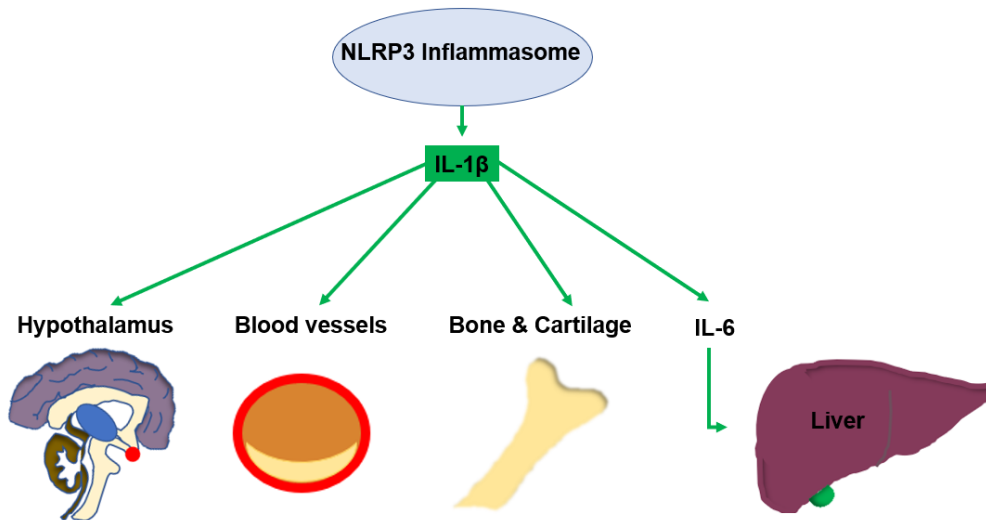

Interleukin-1 $\beta$  acts on the hypothalamus to induce fever, on the blood vessels to induce chemokines release and adhesion molecule expression, resulting in leukocyte recruitment. IL-1  $\beta$  also stimulates interleukin-6 (IL-6) production in the endothelium. IL-1 $\beta$  stimulates bone to induce bone resorption and the breakdown of cartilage. It is directly proinflammatory to hepatocytes and also indirectly via induction of IL-6.

It has been shown that the recruitment of ASC by NLRP3 is a fundamental step in inflammasome activation, and that if ASC recruitment fails the NLRP3 inflammasome complex does not assemble. The formation of the NLRP3-ASC association is a crucial step in the activation of the inflammasome and occurs via the pyrin domains of each molecule. Additionally, the ASC has a caspase activation and recruitment domain (CARD) which recruits other caspases and forms a distinct entity, the pyroptosome, which rapidly recruits and activates caspase-1 resulting in pyroptosis, a form of necrotic cell death, and the release of the intracellular proinflammatory cytokines [110]. This process is tightly regulated at each stage and gain of function mutations in the NLRP3 gene cause the autoinflammatory disease Cryopyrin-Associated Periodic Syndrome (CAPS) a

spectrum of clinical manifestations that result from chronic life-long inflammation[111].

**Figure 1.7: The NLRP3 inflammasome**

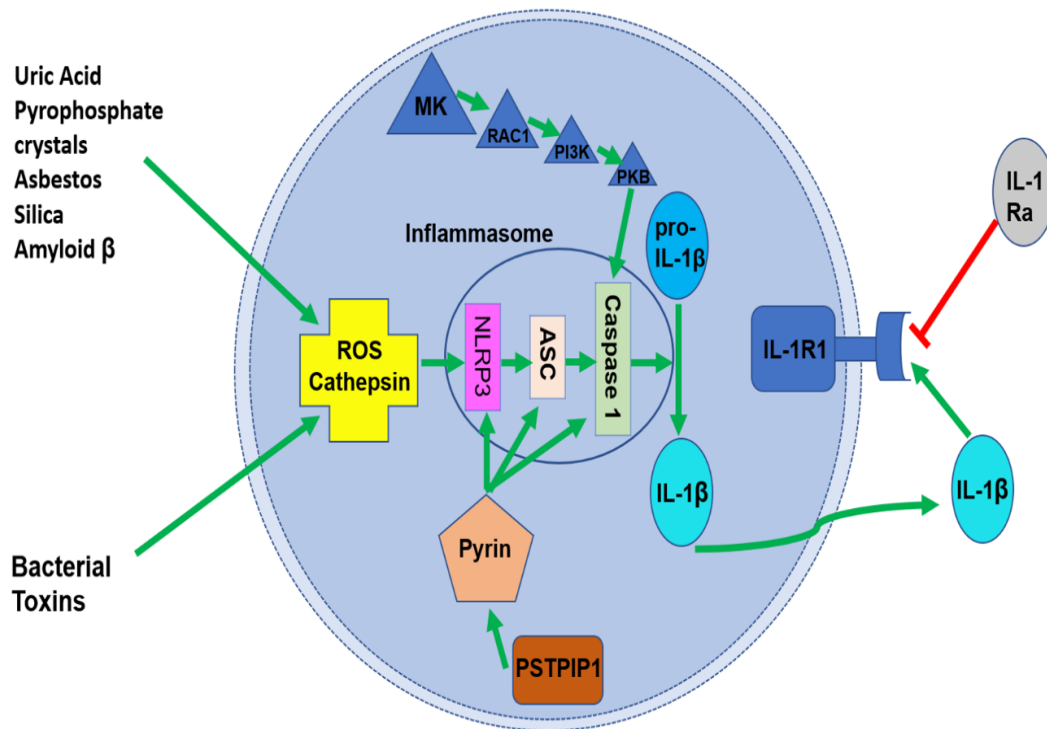

The NLRP3 inflammasome tightly regulates activation of IL-1 $\beta$ . It is comprised of NLRP3, ASC and caspase-1. It is activated by endogenous compounds such as uric acid and pyrophosphate crystals, asbestos, silica and amyloid  $\beta$ . It is also activated by exogenous bacteria toxins. Both pathways involve reactive oxygen species (ROS) and cathepsin B. Activation of the inflammasome leads to cleavage of Pro-IL-1 $\beta$  to form IL-1  $\beta$ . There is a naturally occurring IL-1 receptor antagonist, IL-1Ra and deficiency of this causes the disease phenotype DIRA. PSTPIP1 and pyrin may also influence the inflammasome as may mevalonate kinase through a Rac1/P13K/PKB pathway[112, 113]. PAPA is caused by mutations in PSTPIP1 and mutations in pyrin cause FMF and PAAND. Mutations in NLRP3 cause CAPS and mutations in MK cause MKD.

Pyrin, a 781 amino acid protein, interacts with the ASC via their respective pyrin domains [114]. It is expressed by mature neutrophils, dendritic cells and macrophages in response to pro-inflammatory cytokines and co-localises with microtubules via its N-terminal domain and forms a pyrin inflammasome complex for caspase-1 activation. By detecting inactivating modifications of host RhoA GTPases, pyrin senses pathogen toxin activity rather than directly recognizing the molecule[115]. Thus, RhoA-modifying toxins from bacteria such as *Clostridium difficile*, *Vibrio parahaemolyticus*, *Histophilus somni*, *Clostridium botulinum*, *Burkholderia cenocepacia* and *Yersinia pseudotuberculosis* trigger activation of pyrin via a conserved dephosphorylation mechanism[116]. Thus, pyrin is an intracellular pattern recognition receptor that assembles inflammasomes in response to detecting homeostasis-altering molecular processes (HAMPs) from pathogens. However, it must have both pro- and anti-inflammatory actions. Loss of function mutations in the B30.2/SPRY domain of pyrin cause pathogen-independent activation of pyrin resulting in the periodic fever syndrome; Familial Mediterranean Fever (FMF)[117, 118].

Interestingly, in its inactive state, pyrin is phosphorylated by serine-threonine kinases and is bound to regulatory proteins with the 14-3-3 motif that block the pyrin inflammasome [119]. When triggered in response to RhoGTPase modifications, there is dephosphorylation and loss of 14-3-3 binding resulting in increased pyrin inflammasome activation and enhanced IL-1 $\beta$  production. A heterozygous mutation, p.Ser242Arg leads to the loss of the crucial 14-3-3 binding and is now known to be the causative mutation in the syndrome pyrin-associated autoinflammation with neutrophilic dermatosis (PAAND)[120]. Those with PAAND have recurrent fever, severe acne with skin abscesses, pyoderma gangrenosum, and musculoskeletal symptoms. Similarly, PAPA syndrome, pyogenic arthritis with pyoderma gangrenosum and acne, is caused by mutations in *PSTPIP1*, an interactor of pyrin[121]. It has recently been shown that RhoA inactivation and consequent pyrin inflammasome activation occurs in another periodic fever, mevalonate kinase deficiency (also known as hyper-IgD syndrome, or HIDS) connecting previously seemingly unconnected autoinflammatory diseases[122].

## **The Periodic Fever Syndromes**

### **Familial Mediterranean fever (FMF)**

Familial Mediterranean fever (FMF) is the most commonly diagnosed inherited autoinflammatory disease and is most prevalent among populations originating from the eastern Mediterranean[104]. FMF was the first autoinflammatory disease associated with a single gene. In 1992 as part of a systematic genome-wide search, the gene was mapped to the short arm of chromosome 16[117]. By 1997 the gene was identified as the MEFV gene at 16p13.3 and was found to encode the protein marenosttrin, now referred to as pyrin[123].

FMF is typically described as an autosomal-recessive disease characterized by acute discrete attacks of fever with serositis so severe it can mimic appendicitis. 341 sequence variants have been identified in the MEFV gene, however only approximately 60 of these are considered pathogenic[103]. Most common pathogenic variants are located in exon 10 and M694V is the pathogenic variant with the most severe phenotype[124]. It is also the variant associated with the autosomal dominantly inherited FMF seen in Northern European Caucasians, with a common haplotype suggesting a single founder living in the UK during the Wars of the Roses in around 1460[125].

In addition to fever and serositis, patients also describe arthralgia and can have overt synovitis. A characteristic erysipelas-like rash is well-recognised, especially in paediatric cases. The Tel Hashomer criteria are the most commonly used for the diagnosis of FMF in children and there are a number of other diagnostic criteria with varying degrees of validity in different populations[126].

Discrete attacks are associated with a marked acute phase response which spontaneously resolves in the majority of cases. However, even when well, up to 30% of patients can have clinically silent inflammation and this confers a high lifetime risk of developing AA amyloidosis[127].

In 1972 the first report that colchicine could prevent attacks of FMF was published[128]. The efficacy of colchicine was subsequently established in clinical trials [129]. This is reflected in current guidelines[130]. The mechanism of action of colchicine in FMF remains elusive but all science students are aware of its action on the spindle fibres of dividing cells[131]. It is known that the cytoskeleton is involved in the activation of inflammasomes and it is possible that colchicine-induced disruption of microtubules may reduce inflammasome activation[118].

Those who don't respond to colchicine may not be compliant, but in those with true colchicine refractory FMF the IL-1 inhibitors are highly effective and canakinumab has been recently licenced for this indication[102].

### **Cryopyrin-associated periodic syndrome (CAPS)**

Cryopyrin-associated periodic syndrome (CAPS) encompasses a spectrum of clinical presentation previously thought to be three separate diseases it was brought together by the finding of a common gene mutation; (i) Familial cold autoinflammatory syndrome (FCAS), (ii) Muckle-Wells syndrome (MWS) and the more severe (iii) Chronic Infantile Neurological Cutaneous Articular (CINCA), also known as neonatal onset multisystem inflammatory disease (NOMID) (Table 2).

CAPS is a rare disease, affecting one to three per million children and adults worldwide[111]. There is no gender or ethnic predilection. CAPS is caused by gain of function mutations in the NLRP3 gene, located at chromosome 1q44[132]. The NLRP3 gene codes for the NALP3 protein predominantly expressed by macrophages and an important constituent of the IL-1 inflammasome. There are currently 210 known mutations in the NALP3 protein, 96 of which are considered pathogenic[103]. Most of these variants are single nucleotide substitutions which result in the over-activation of the inflammasome[133]. Most commonly inheritance is autosomal dominant, but de novo mutations and somatic mosaicism is increasingly recognised[134].

Recently validated diagnostic criteria have been established for this condition[111]. This international expert consensus study identified variables significantly

associated with CAPS ( $p < 0.001$ ); raised inflammatory markers (C-reactive protein/serum amyloid A), plus  $\geq$ two of six CAPS-typical symptoms: urticaria-like rash, cold-triggered episodes, sensorineural hearing loss, musculoskeletal symptoms, chronic aseptic meningitis and skeletal abnormalities. Attacks may last up to 12 hours and some patients have constitutively active inflammation from birth. Severely affected individuals may experience conjunctivitis, sensorineural deafness, arthritis, significant fatigue and headaches secondary to raised intracranial pressure. Those with CINCA/NOMID can experience severe deforming arthritis, chronic aseptic meningitis, optic nerve atrophy and mental retardation. Systemic AA amyloidosis is common and seen in approximately 25% of patients with considerable morbidity and mortality as already discussed in this chapter.

In 2003, two patients with CAPS and AA amyloidosis were treated with the interleukin-1 receptor antagonist anakinra[101]. These two cases demonstrated a rapid, sustained clinical, biochemical and organ response with no symptoms, suppressed SAA and reduction in proteinuria.

This dramatic response and the further study of those with CAPS dramatically improved the understanding of the role of IL-1 $\beta$  in inflammation[135]. Later a fully human monoclonal antibody that neutralizes the bioactivity of human IL-1 $\beta$  was generated to study the potent and long-lasting neutralization of IL-1 $\beta$  in mechanistic animal models [136]. This demonstrated complete suppression of IL-1 $\beta$ -mediated joint inflammation and cartilage destruction in mice and led to the investigation of this monoclonal antibody in those with CAPS. Canakinumab is an anti-interleukin-1 $\beta$  monoclonal antibody that selectively blocks interleukin-1 $\beta$ . It has no cross-reactivity with other IL-1 family members, including IL-1Ra. A multicentre, randomized, double-blind, placebo-controlled clinical trial of canakinumab in CAPS demonstrated rapid and sustained efficacy, with the advantage that it is given only every eight weeks compared to daily anakinra injections [137]. The use of canakinumab in CAPS is now well established and the National CAPS treatment service is run by and from the NAC. Canakinumab has now shown proven efficacy in colchicine resistant FMF, MVKD and TRAPS[102].



## **Tumour necrosis factor receptor associated periodic fever syndrome (TRAPS)**

TRAPS was initially known as familial Hibernian fever after its first description in an Irish family with a steroid-responsive periodic fever with localized myalgia, painful erythema, abdominal pain and pleurisy, inherited in an autosomal dominant fashion[138]. Subsequently an analysis of seven affected families found missense mutations in the gene tumour necrosis factor receptor superfamily member 1A (*TNFRSF1A*), on chromosome 12[139]. There have now been 158 reported sequence variants, most within exons 2 or 4, 98 of which are considered pathogenic[103].

TRAPS is a rare disease and the phenotype is characteristically broad. Its diagnosis relies on clinical suspicion supported by evidence of biochemical inflammation and genetic testing[140]. Thirty-three per cent are diagnosed in adulthood and 9.1% reported their first symptoms after the age of 30[141]. Although recurrent discrete inflammatory episodes are commonest, 5% of patients experienced continuous symptoms with exacerbations. The most common presenting symptom is fever with rigors at onset, with abdominal pain, myalgia, arthralgia, cervical lymphadenopathy, maculopapular rash and periorbital oedema in decreasing order. In the EUROTRAPS registry AA amyloidosis developed in 10% of 158 patients with a median age of 43 years[141].

The mechanisms by which mutations in the *TNFRSF1A* gene result in inflammation remain poorly understood. Pathogenic mutations appear to lead to misfolding of the TNFR1 protein, which accumulates in the endoplasmic reticulum, leading to defective autophagy, which in turn induces excessive IL-1 $\beta$  secretion via activation of the NLRP3 inflammasome[142].

Episodes are responsive to high-dose corticosteroids but conventional steroid-sparing immunosuppressive drugs are not effective[143]. Anti-TNF treatment was trialled due to the underlying aetiology of the diseases and initially results with etanercept were positive[143]. However, it is now recognised that IL-1 inhibitors

not only treat the disease but also significantly reduce the risk of AA amyloidosis[144]

### **Mevalonate kinase deficiency (MKD)**

MKD is a rare autosomal recessive disease that has two distinct phenotypes; (i) absent enzyme activity causing the metabolic disorder mevalonic aciduria, (ii) the autoinflammatory disease whereby 10% residual enzyme activity remains, and a periodic fever syndrome begins within the first 6 months of life. These two phenotypes were initially thought to be separate conditions but were subsequently linked with the discovery of shared variants in the *MVK* gene on chromosome 12q24[145]. To date, there are 217 reported variants in the *MVK* gene, 131 of which are considered to be pathogenic[103].

The pathologic mechanisms of the autoinflammatory phenotype of MKD are poorly understood. *MVK* has a physiological role in cholesterol biosynthesis and in the synthesis of non-sterol isoprenes, such as geranylgeranyl pyrophosphate and in the conversion of mevalonic acid to mevalonate-5-phosphate[146]. It is thought that the reduced synthesis of geranylgeranyl pyrophosphate plays an important role in pathogenesis as it is necessary for the prenylation of small GTPases including RhoA and Rac1. As previously discussed, this may lead to over activation of the pyrin inflammasome with abundant production of IL-1  $\beta$ [147].

Initially known as hyperimmunoglobulin D and periodic fever syndrome (HIDS), the diagnosis requires either two mutations in the *MVK* gene or one mutation with evidence of abnormal metabolism; raised urinary mevalonic acid during attacks or reduced *MVK* enzyme activity in leucocytes or fibroblasts[148].

In the EUROFEVERs registry of 114 MKD patients; the median age at onset was 0.5 years[149]. Patients had on average 12 episodes per year consisting of; gastrointestinal symptoms (98%), mucocutaneous involvement (86%), lymphadenopathy (89%), musculoskeletal symptoms (78%), headache (38%), cerebellar syndrome (1.75%), and mental retardation (3.5%). AA amyloidosis was noted in 4% of patients.

Treatment of MKD is not as established as the other main hereditary periodic fevers. As mevalonate kinase, follows 3'-hydroxy-3'-methylglutaryl-coenzyme A (HMG-CoA) reductase in the isoprenoid pathway, statins have been used in this condition[150]. Small studies have shown benefit of statins but a clinical trial shows only a partial response in 27% and complete response in none[151]. Similarly, corticosteroids, NSAIDs and colchicine have shown mixed responses. IL-1 inhibition is now recommended but again the response is not as profound as in the other periodic fevers[152]. Canakinumab has demonstrated most efficacy and is now licenced for the treatment of MKD[102]. The humanised monoclonal antibody targeting the IL-6 receptor, tocilizumab, has been used in a few cases of refractory MKD with success[153]. There have been reports of mevalonic aciduria cured by bone marrow transplantation[154].

The features and inheritance of the main monogenic autoinflammatory diseases and those that are more recently described but pertinent to this thesis, are outlined in Table 2. This figure includes the disease deficiency of ADA2 (DADA2) which was first described the year before work on this thesis began.

### **Deficiency of ADA2 (DADA2)**

In March 2014 two separate groups published a syndrome of early-onset vasculopathy, haemorrhagic and ischaemic stroke and both clinical and histopathological evidence of polyarteritis nodosa (PAN) vasculitis [155, 156]. The gene, now known as ADA2 encodes the enzyme adenosine deaminase 2, a dimeric extracellular enzyme, that is involved in the purinergic signalling pathway by irreversibly converting 2'-deoxyadenosine to 2'-deoxyinosine[157]. Patients with a variety of mutations in this gene have been shown to have very low or absent ADA2 activity in the blood[158]. The syndrome was termed Deficiency of ADA2 (DADA2), the CECR1 gene renamed as ADA2, and since 2014 over 200 cases have been published in the literature. These cases describe a highly variable phenotype of vasculopathy, vasculitis and immunodeficiency, the latter clinical manifestation is of importance given that ADA1 deficiency is the cause of severe combined immunodeficiency and is fatal if not treated with enzyme replacement, gene therapy or stem cell transplantation[159].

The pathogenesis of DADA2 and the disease phenotype and its management are explored in detail in chapter 7.

**Table 1.2: Genetic and clinical characteristics of monogenic autoinflammatory diseases**

Syndrome	Protein	Gene	Clinical Features	Treatment
<b>FMF</b> Familial Mediterranean Fever	Pyrin	<i>MEFV</i> Chromosome 16 Autosomal Recessive A few dominant variants described	Fever Serositis Arthralgia Arthritis Erysipelas-like rash	Colchicine IL-1 inhibition
<b>PAAND</b> Pyrin associated autoinflammation with neutrophilic dermatosis	Pyrin	<i>MEFV</i> Chromosome 16 Autosomal recessive	Fever Severe acne Skin abscesses, Pyoderma gangrenosum, Musculoskeletal symptoms	Colchicine IL-1 inhibition
<b>PAPA</b> Pyogenic arthritis, pyoderma gangrenosum and acne	Proline-serine-threonine phosphatase-interacting protein 1	<i>PSTPIP1</i> Chromosome 15 autosomal dominant	Deforming arthritis and skin lesions due to sterile, pyogenic, neutrophil-rich inflammatory infiltrate	Treatment of acne Anti-TNF IL-1 inhibition
<b>CAPS</b> Cryopyrin associated periodic syndrome	Cryopyrin (NALP3)	<i>NLRP3</i> Chromosome 1 Autosomal dominant	<b>FCAS:</b> Cold induced urticaria, Fever, arthralgia, conjunctivitis, and headache <b>MWS:</b> Similar to FCAS but symptoms less temperature dependant and can occur daily. Progressive sensorineural hearing loss <b>CINCA/NOMID:</b> Progressive aseptic meningitis, visual and hearing loss, mental retardation, severe deforming arthritis	IL-1 inhibition
<b>TRAPS</b> TNF Receptor Associated Periodic Syndrome	TNF receptor	<i>TRNRSF1A</i> Chromosome 12 Autosomal dominant	Fever Abdominal pain Myalgia Arthralgia Cervical lymphadenopathy Maculopapular rash Periorbital oedema	Steroids IL-1 inhibition
<b>MKD (HIDS)</b> Mevalonate kinase deficiency (hyper IgD syndrome)	Mevalonate kinase	<i>MVK</i> Chromosome 12 Autosomal recessive	Onset within 6 months of birth: Fever Gastrointestinal symptoms Maculopapular rash Lymphadenopathy, Arthralgia Oral aphthae Headache Ocular inflammation. Episodes triggered by; vaccination, infection or stress	Statins Steroids NSAIDS IL-1 inhibition IL-6 inhibition
<b>FCAS2</b> Familial Cold	Monarch-1	<i>NLRP12</i> Chromosome 19	Rash Urticaria	Cold avoidance

Autoinflammatory Syndrome-2		autosomal dominant	Arthralgia Myalgia Headache Fever Episodes cold induced in most cases	Steroids IL-1 inhibition
<b>DIRA</b> Deficiency of the IL-1 receptor antagonist	Interleukin-1 receptor Antagonist (IL-1RA)	<i>IL1RN</i> Chromosome 2 Autosomal recessive	Arthritis Skin pustulosis Respiratory involvement Osteomyelitis Fused cervical vertebrae Oral ulceration Hepatomegaly	IL-1 inhibition
<b>DITRA</b> Deficiency of the IL-36 receptor antagonist	Interleukin-36 receptor antagonist	<i>IL36RN</i> Chromosome 2 Autosomal recessive	Generalised pustular psoriasis Fever	IL-1 inhibition
<b>Majeed Syndrome</b>	Lipin-2	<i>LPIN2</i> Chromosome 18 Autosomal recessive	Fever Chronic recurrent multifocal osteomyelitis Dyserythropoitic anaemia: Fatigue, pallor, weakness, shortness of breath Neutrophilic dermatoses	NSAIDS IL-1 inhibition
<b>Blau Syndrome</b>	NOD2	<i>NOD2</i> Chromosome 16 Autosomal dominant	Rash in infancy Arthritis with cystic swelling Uveitis Noncaseating granulomas present in skin, synovial (joint) or conjunctival (eye) biopsies Inflammatory bowel disease symptoms	NSAIDS Steroids Anti-TNF
<b>CANDLE</b> Chronic atypical neutrophilic dermatosis with lipodystrophy and elevated temperature syndrome	Proteasome subunits	<i>PSMB8</i> Chromosome 6 Autosomal recessive	Daily fever from infancy Facial lipodystrophy Thick lips Swollen violaceous eye lids Arthralgia Episcleritis Clubbing Hepatomegaly	Current trial underway of an Interferon signalling inhibitor
<b>SAVI</b> STING-associated vasculopathy with onset in infancy	STING stimulator of interferon genes	<i>TMEM173</i> Chromosome 5q31 Autosomal dominant	Vasculopathy Skin lesions of face, ears, nose, digits Ulceration and necrosis Interstitial lung disease	Current trial underway with JAK inhibitors
<b>DADA2</b> Deficiency of Adenosine deaminase 2	Adenosine deaminase 2	<i>ADA2</i> Chromosome 22 Autosomal recessive (carrier status may exist)	Recurrent lacunar strokes Polyarteritis nodosa-like vasculitis Hypogammaglobulinemia Red cell aplasia Bone marrow failure	Anti-TNF therapy

## **Aims and Scope of Thesis**

This thesis aims to explore the hypothesis that increased understanding of the pathogenesis of the systemic amyloidoses and periodic fever syndromes can lead to improved diagnostics and earlier targeted therapies.

The multisystem nature of these conditions represents a challenge to the general physician. Understanding the significance of early clinical signs and symptoms of these diseases and the utility of novel diagnostics tests may improve diagnostic uncertainty and delay in non-specialist centres.

Specifically, the clinical significance of transthyretin amyloid deposition in non-cardiac tissues is investigated in Chapters Three and Four, including the utility of the novel diagnostic technique of carpal tunnel biopsy, which also provides information about the early natural history of ATTRwt amyloidosis. Understanding the early phase of this form of cardiac amyloidosis is particularly important now that there are licenced treatments for this condition including TTR stabilisers which, if given early, may ultimately be used to prevent the development of cardiac amyloidosis. Carpal tunnel syndrome is a common presentation to general practice, surgery and medical clinics. Developing the technique of carpal tunnel biopsy may identify many cases of the disease at a more treatable stage.

Understanding the natural history of amyloidosis is also of importance in AA amyloidosis as this condition is always secondary to chronic or recurrent inflammation which requires treatment in its own right. Chapter Five describes the changing aetiology of AA amyloidosis over time. The largest increasing cohort is idiopathic amyloidosis and the novel observation that obesity may be an emerging cause of AA amyloidosis is explored.

Autoinflammatory diseases have a high risk of AA amyloidosis and are also likely to be significantly under diagnosed. This will almost certainly change with the wider spread use of whole genome sequencing. The treatment of these conditions has been transformed by the use of IL-1 antagonism, which has restored the normal life experience and expectancy in the majority of those who reliably take

these medicines. Yet there has been no safety data on the use of these agents at conception, pregnancy and breast feeding. The children who were the first to be diagnosed with these genetic diseases in childhood and treated with these medications, are now young adults and many are unable to stop treatment and yet wish to become parents. Chapter Six presents the international data on the use of anakinra at conception, throughout pregnancy and during breast feeding. The first ever data on the use of canakinumab at conception, pregnancy and breast feeding is also described as well as the first data on paternal exposure to IL-1 inhibitors at conception.

The final results chapter describes a novel genotype of a recently described autoinflammatory disease, Deficiency of Adenosine Deaminase 2 (DADA2). It is increasingly recognised that immunodeficiency and autoinflammation are linked and DADA2 has a broad phenotype ranging from a vasculitic polyarteritis nodosum-like illness, to immunodeficiency but, unusually for autoinflammatory disease, does so without significant systemic inflammation. The data from an international expert consensus Delphi study on the diagnosis and management of DADA2 is described and the heterozygous state explored.

Summary of aims:

1. To investigate TTR amyloid and describe non-cardiac TTR deposition and its clinical significance
2. To determine the role of carpal tunnel biopsy in diagnosis of TTR amyloidosis
3. To investigate and define the changing aetiology of AA amyloidosis
4. To investigate the safety of IL-1 antagonism for autoinflammatory disease in pregnancy
5. Delphi consensus study to define phenotype and management approaches in the autoinflammatory disease DADA2



**Chapter Two:**  
**Materials and Methods**

## **Study Design**

The clinical studies in this thesis were designed by myself as a result of discussions with my supervisors Professor Philip N Hawkins and Dr Helen J Lachmann. I collected the data and performed all the statistical analyses using Excel and Graphpad Prism (Version 5). In Chapter 3 data collection was aided by others in the team and where this occurred it is clearly stated. Individual statistical methods are discussed separately in each results' chapter.

## **Patients**

Patients for all studies were referred to and investigated at the National Amyloidosis Centre (NAC). In Chapter 4 tissue was referred to the NAC for histological examination in its role as a national reference centre for the diagnosis of amyloid.

The NAC maintains a database of clinical information including examination, history, clinic letters, investigations and serology and this was used to collect the retrospective data.

Individual methods pertinent to each chapter are described in the relevant chapters. Below is described the methods that are generally applicable to the thesis.

## **Histopathology and immunohistochemistry**

Histological and immunohistochemical analyses were performed by Janet Gilbertson, Nicola Botcher and Karen Boniface using standard protocols at the NAC:

Formalin-fixed de-paraffinised tissue sections were cut to a 6-8  $\mu\text{m}$  thickness and rehydrated then counter stained with haematoxylin under running tap water. Congo red was applied using the method described by Puchtler and colleagues[5]. A series of ascending ethanol concentrations to xylene were used to dehydrate the sections which were then mounted in DPX mounting medium. The specimen was then viewed under both brightfield and under cross-polarised light. Positive controls were always processed and viewed in parallel. Confirmation of amyloid presence was performed using anti-SAP immunostaining.

The sections were then washed with water and incubated in aqueous (0.3%) hydrogen peroxide (H<sub>2</sub>O<sub>2</sub>) for 30 minutes. Sections are then washed in phosphate-buffered saline (PBS) containing 0.05% Tween (Calbiochem). The sections are then incubated for a further 30 minutes in normal non-immune serum prior to the application of antisera for the immunostaining. After overnight incubation at 4°C the sections are rinsed with PBS containing 0.05% Tween (Calbiochem) and labelled with secondary antibodies. Sections are further washed in PBS and bound immunocomplexes are viewed using a metal-enhanced DAB (Fisher Scientific solution). Commercial immunostains are used and positive and negative controls run in parallel with each stain. A panel of anti-human monospecific antibodies reactive with: SAA (Eurodiagnostica, Huntington UK) AL kappa, lambda, transthyretin and lysozyme (Dako Ltd, Denmark House Ely UK), Apolipoprotein AI (Genzyme Diagnostics) and fibrinogen A $\alpha$  chain (Calbiochem) were used where appropriate. For TTR staining, pre-treatment was performed for enhanced antigen retrieval using 10-minute incubation with 1% sodium periodate, slides were then washed and further incubated for 10 minutes with 0.1% sodium metabisulphate, washed again and incubated for 5 hours at room temperature with 6M Guanadine in 0.9% sodium chloride. Immunohistochemically stained sections were counterstained in haematoxylin, 'blued' under running tap water and stained with Congo-red to aid the classification of amyloid deposits.

### **Biochemical and haematological data**

These were performed by the Royal Free Hospital laboratory services using standard protocols.

### **Serum Amyloid A Protein immunoassay**

SAA levels were measured using latex nephelometry (BNII autoanalyser Dade, Behring Marbury, Germany)[160]. The lower limit of detection is 0.7mg/L. Standardisation was based on WHO international reference standards 1987[161].

## Genetic analysis

Gene sequencing was performed by Dorota Rowczenio and Hadija Trojer using their standardised technique: Whole blood was taken in an EDTA tube and stored for at least 24 hours at -20 °C. Genomic DNA was isolated using a rapid method[162]. 800 µl of sterile, freshly prepared 0.17 M NH<sub>4</sub>CL and 200 µl of blood were mixed thoroughly in a 1.5 ml eppendorf tube and incubated at room temperature for 20 minutes. The blood was thawed out thoroughly before the DNA extraction. 800 µl of sterile, freshly prepared 0.17 M NH<sub>4</sub>CL and 200 µl of blood were mixed thoroughly and incubated at room temperature for 20 minutes then spun 1 minute at 12000 rpm and the supernatant was discarded. 800 µl of cold 0.9% NaCl was added, mixed thoroughly and spun for 1 minute at 12000 rpm. The supernatant was discarded. The sample goes through repeated rounds of dilution and spinning until red blood cells were no longer visible in the pellet. The pellet was then re-suspended in 400 µl of 0.05 M NaOH. The sample was heated at 99°C for 10 minutes, then cooled down at room temperature for 5 minutes. DNA was neutralised with 50 µl of 1M Tris pH8. Commercially available kits are used for the PCR see table 2.1.

**Table 2.1: Commercially available PCR kits used in the amplification of gene sequences in hereditary amyloidosis and periodic fever syndromes**

PCR Kit	Gene	Exon
HotstarTaq DNA Polymerase Kit	<b>Amyloid:</b> <i>LYZ</i> <i>GSN</i> <i>SAA1</i> <b>Fever:</b> <i>NLRP3</i> <i>TNFRSF1A</i> <i>MVK</i> <i>ApoA2</i> <i>MEFV</i>	2 and 4 4 3 3 2-7 2-10 4 5 and 10
PureTaq RTG PCR Kit	<b>Amyloid:</b> <i>TTR</i> <i>ApoA1</i> <i>FGA</i> <b>Fever:</b> <i>MEFV</i> exons 1, 3 and 9 <i>MVK</i> exon 11	2-4 3 and 4 5 1, 3 and 9 11

<b>Advantage® GC Genomic LA Polymerase mix</b>	<b>Fever:</b> <i>MEFV</i>	2
--	------------------------------	---

### **Laser capture microdissection and proteomic mass spectrometry**

The NAC technique is described by Rezk and colleagues, 2019[31]. Stained CR sections were viewed under brightfield and fluorescence using the Leica LMD7 laser capture microscope. Areas positive for amyloid were laser micro-dissected into micro-centrifuge caps. Proteins were extracted from each sample into 10mM Tris/1mM EDTA/0.002% Zwittergent buffer solution (35µl) by heating (99°C for 1.5hours) followed by sonication (1hour) and then digested with trypsin (25ng/sample) overnight at 37°C. Each digested sample was reduced with dithiothreitol (50µg) at 99°C for 5min, freeze dried, reconstituted in 0.1% v/v trifluoroacetic acid in HPLC grade water (20µl) and analysed by HPLC-MSMS using a Thermo Scientific Q-Exactive Plus mass spectrometer coupled to a Dionex Ultimate 3000 RSLC nanoLC using a Thermo Easy-spray Acclaim Pepmap column (75µm x 15cm, 3µm/100Å packing). MS raw data files were queried using Matrix Science's Mascot search engine (<http://www.matrixscience.com>) and the SwissProt database to assign peptide and protein probability scores. Amyloid was established by LDMS on the basis of the presence of the amyloid signature proteins defined by the presence ( $\geq 1$  unique specific peptide) of two or more of the following proteins; apolipoproteinE(APOE), apolipoprotein A-IV (APOA4) and serum amyloid P component (SAP). The amyloid fibril protein was determined by a Mascot score of  $>80$  coupled with at least 2 unique specific peptides of a known amyloid fibril protein together with absence (Mascot score  $<80$  or fewer than 2 unique specific peptides) of other known amyloid fibril proteins.

### **SAP Scintigraphy**

Highly purified SAP is radiolabelled with the gamma emitting isotope  $^{123}\text{I}$ . Each subject undergoing SAP scintigraphy receives 60mg of potassium iodide immediately prior to the study and then 5 further doses over the next three days to

block thyroid uptake of the radioactive iodine. They receive approximately 200µg of SAP with 190MBq of <sup>123</sup>I by bolus intravenous injection (3.8 mSV of radiation). In those with visceral amyloid deposits the tracer is localised to the affected sites in proportion to the amyloid amount present. Anterior and posterior imaging at either 6 or 24 hours after injection is performed. The imaging is performed by David Hutt and his team of radiographers at the NAC using an Infinia Hawkeye gamma camera (General Electric). The images were reviewed at the time of acquisition by the clinical team at the NAC. The diagnostic sensitivity in patients with AA amyloidosis is 100% and ~90% in AL amyloidosis. In subjects without visceral amyloid deposits the tracer is rapidly catabolised and excreted. The classification of whole-body amyloid load is as follows; (i) None = no abnormal localisation of tracer; (ii) Small = visceral uptake visible but the intensity of the blood-pool remains normal, (iii) Moderate = abnormal uptake is sufficiently intense to partially lose the blood-pool signal, (iii) Large = the blood-pool signal is lost on adjustment of the grey scale to encompass the target-organ signal.

Serial SAP scintigraphy is performed at six-monthly or annual intervals to monitor change in amyloid load. Stable amyloid load = uptake remained unchanged. Regression = reduction in tracer uptake or an increase in the blood-pool signal, or both. Progression = increase in tracer uptake in affected organs, new abnormal tracer uptake in a previously unaffected organ, or a decrease in the blood-pool background signal.

#### **<sup>99m</sup>Tc-DPD scintigraphy**

NAC technique as described by Hutt and colleagues, 2017[163]. Patients were administered 700 MBq of <sup>99m</sup>Tc-DPD intravenously and imaged 3 hrs later on either a General Electric (GE) Infinia Hawkeye 4 or GE Discovery 670 hybrid gamma camera. Whole body images were acquired followed by a SPECT-CT (single photon emission computed tomography with a low-dose, non-contrast CT scan) of the heart[164]. The expected radiation dose from the entire procedure was 6.7 mSv per patient. The Perugini grading system is described in Chapter 3[37].

## **Chapter Three:**

### **The clinical significance of transthyretin amyloid deposits in non-cardiac tissues**

Demographic and baseline data collection for this chapter was aided by Dr Sajitha Sachchithanantham for cases 1-12 and Dr Katie David for cases 14-24.

## Introduction

Wild-type transthyretin amyloidosis, previously known as Senile systemic amyloidosis, is a disorder characterised by the deposition of transthyretin as amyloid within the myocardium [165]. Transthyretin (TTR) is a circulating plasma protein, previously known as pre-albumin, that acts as a transport protein for retinol bound to retinol binding protein and thyroxine. The TTR molecule is inherently amyloidogenic and although the *in vivo* mechanism for this remains unclear, mutations in the TTR gene can predispose to formation of amyloid and are associated with earlier onset disease often with distinctive disease phenotype; Familial amyloid polyneuropathy (FAP) and familial amyloid cardiomyopathy (FAC) [166]. TTR readily forms tetramers and for fibrillogenesis to occur the tetramer must be dissociated (Figure 8). This destabilization process is favoured by amyloidogenic mutations[167]. More than 120 autosomal dominant pathogenic mutations have been described in the TTR gene with the most common mutation being a nucleotide substitution [168]. At the NAC, variants have been found in 17% of those sent for genetic screening. This highlights the need for routine genetic testing in the evaluation of suspected ATTR amyloidosis[9].

The TTR molecule is a homotetramer formed of four monomers. Mutations in the TTR gene as well as strong biomechanical forces (such as shear force within the heart, or agitation *in vitro*), and proteolytic cleavage (by tryptic proteases) have all been reported to play a crucial role in destabilizing the TTR tetramer and in the release of a highly amyloidogenic 49–127 truncated protomer promoting amyloid formation [11]. In contrast, mutations have been identified that increase tetramer stability and are anti-amyloidogenic[9].



**Figure 3.1: Schematic representation of TTR fibrillogenesis**

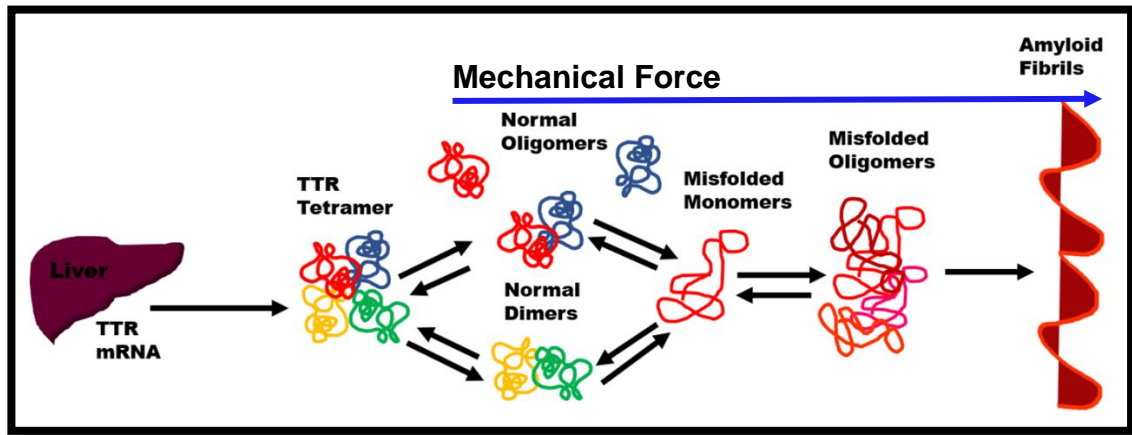

Transthyretin is synthesized in the liver and readily forms tetramers. These tetramers do not form amyloid but when the TTR molecules dissociate they can form amyloid fibrils. Certain mutations in the TTR gene, such as S52P, destabilise the tetramer by disrupting the interconnecting loops between the monomers. Mechanical forces promote this process.

Wild-type ATTR amyloidosis (ATTRwt) is diagnosed in approximately 150 individuals per year in the United Kingdom, but this is likely to be a gross underestimate of the true prevalence of the disease, as TTR deposits have been identified in 25% of deceased males over 80 years at autopsy [169, 170]. It has been classically considered a disease of older males, but this may have been due to ascertainment bias, and women are increasingly being diagnosed with the condition[171]. It is a slowly progressive disease; - median age at diagnosis of 78 years (range 51–95) and median age at death of 81 years (range 63–96) with a median survival from diagnosis of 60 months (range 1–249)[9].

Typical presentation is with advanced heart failure symptoms, but little is known about the early phase of ATTRwt. The only other well-described clinical manifestation of the disease is carpal tunnel syndrome, which can occur up to 10 years before presentation with heart failure symptoms [10]. Although TTR amyloid deposits have been identified in carpal tunnel biopsies [172], in osteoarthritic hip

joints [173], rotator cuff tears and lumbar canal stenosis [174] their association with cardiac disease has not been thoroughly investigated.

The diagnosis of cardiac amyloidosis can only be made definitively by endomyocardial biopsy, but this is not without risk, especially in those with advanced heart failure symptoms [175]. Echocardiography and Cardiac MRI are very informative, as are the serum biomarkers N-terminal pro-B-type natriuretic peptide (NT-ProBNP) and troponin [176, 177]. Table 3 outlines the typical cardiac assessment findings in an individual with ATTRwt.

It is now recognised that whole body scintigraphy with the technetium ( $^{99m}\text{Tc}$ ) Tc-3,3-diphosphono-1,2-propanodicarboxylic acid ( $^{99m}\text{Tc}$ -DPD) tracer is highly sensitive and specific for even clinically silent ATTRwt amyloidosis within the heart, and is now being used routinely to diagnose ATTRwt amyloidosis [40] (Figure 1). The  $^{99m}\text{Tc}$ -DPD scan largely abrogates the need for endomyocardial biopsy and allows for the detection of amyloid within the myocardium, even in those without symptoms or echocardiographic signs.

The intensity of myocardial uptake on  $^{99m}\text{Tc}$ -DPD scan has four grades; 0 to 3, known as the Perugini grading system[37]. A scan is classified as grade 0 is when there is no cardiac uptake and normal bone uptake; grade 1 is where the cardiac uptake is less intense than the bone signal; grade 2 is cardiac uptake with intensity similar or greater than bone signal; and grade 3 is cardiac uptake with attenuated bone signal (Figure 9).

**Table 3.1: Cardiac assessment in ATTRwt**

Investigation	ATTRwt
<b>Clinical Assessment:</b> <ul style="list-style-type: none"> <li>• New York Heart Association Classification (NYHA)</li> <li>• 6-minute walk test</li> </ul>	<ul style="list-style-type: none"> <li>• I-IV</li> <li>• Reduced</li> </ul>
<b>Blood tests:</b> <ul style="list-style-type: none"> <li>• NT-Pro-BNP</li> <li>• Troponin</li> </ul>	<ul style="list-style-type: none"> <li>• Elevated</li> <li>• Elevated</li> </ul>
<b>ECG</b>	Typical features: <ul style="list-style-type: none"> <li>• Low voltage</li> <li>• Pseudo-infarct pattern</li> <li>• Atrial arrhythmias</li> <li>• Meets left ventricular voltage criteria</li> </ul>
<b>Echocardiogram</b>	Typical features: <ul style="list-style-type: none"> <li>• Ventricular hypertrophy</li> <li>• Preserved ejection fraction</li> <li>• Impaired global strain rate</li> <li>• Apical sparing strain pattern</li> <li>• Interventricular wall &gt; 12mm</li> </ul>
<b><sup>99m</sup>Tc-DPD Scintigraphy</b>	Grade 1 = early cardiac uptake Grade 2 = significant cardiac uptake Grade 3 = significant cardiac uptake with bone signal attenuation
<b>Cardiac MRI</b>	Late gadolinium enhancement (global subendocardial pattern) Elevated extracellular volume Elevated native T <sub>1</sub>

**Figure 3.2:**  $^{99m}\text{Tc}$ -DPD Whole Body Scintigraphy depicting Perugini grades 1 to 3 in those presenting following the identification of TTR amyloid in non-cardiac tissue

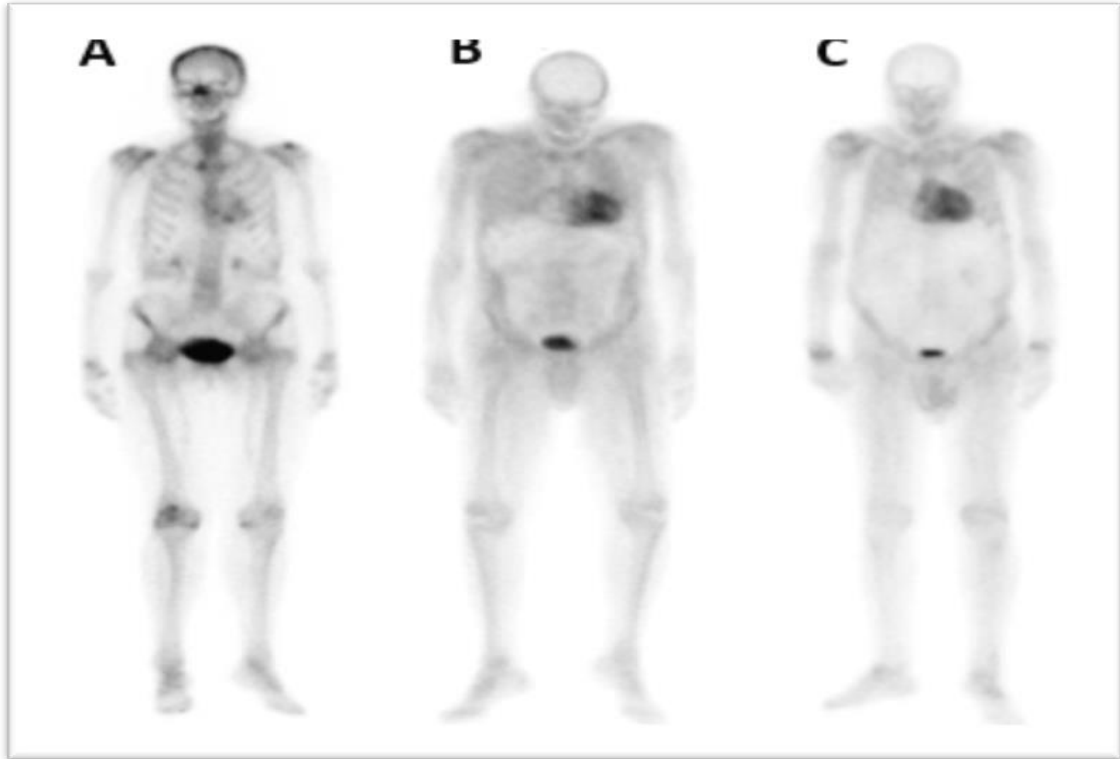

**A**  $^{99m}\text{Tc}$ -DPD scintigraphy revealing Perugini grade 1 cardiac uptake in an 85 year-old female following detection of TTR amyloid deposits in a bone marrow biopsy investigating paraproteinaemia. At time of scan she was NYHA II, NT-ProBNP and Troponin were in the normal range, ECG showed normal sinus rhythm and echocardiogram showed 1cm ventricular walls. There remains no progression at 3.9 years of follow-up (Case 15).

**B** Perugini grade 2 cardiac uptake in a 73 year-old male with TTR amyloid detected at bladder biopsy for frank haematuria. He had a history of bilateral carpal tunnel decompression, was NYHA class II at presentation and echocardiogram was characteristic of cardiac amyloidosis with 1.5 cm wall thickness, atrial fibrillation and raised serum cardiac biomarkers (Case 3). There was evidence of progression over 6 years of follow-up.

**C** Perugini grade 3 cardiac uptake (loss of femoral bone signal likely secondary to increased soft tissue amyloid) in an 82 year-old man with TTR amyloid found at bladder biopsy again for haematuria. He had a history of bilateral carpal tunnel decompression surgery and atrial fibrillation, was NHYA class II at presentation, had raised serum cardiac biomarkers and had an echocardiogram characteristic of amyloidosis (Case 1).

Nonetheless, histology remains the gold standard for the identification and typing of amyloid fibrils in tissue.

Although ATTRwt amyloidosis is largely a disease of the 8<sup>th</sup> and 9<sup>th</sup> decades it is undoubtedly life shortening and progressive congestive cardiac failure results in a poor quality of life with increasing frailty and dependency. There is no proven specific treatment for ATTRwt amyloidosis.

Management of heart failure symptoms with diuretics has, until recently, been the mainstay of treatment for ATTRwt amyloidosis. Beta blockers, ACE inhibitors, calcium channel antagonists and digoxin may be may be harmful despite their efficacy in other types of heart failure[178]. Thromboembolic risk is high and should be standard therapy in those with atrial fibrillation, although a higher bleeding risk exists[177]. There is limited data on the use of pacing and cardiac transplantation in ATTRwt and this requires further evaluation. There is a larger evidence base for solid organ transplantation in those with Familial Amyloid Polyneuropathy with either liver transplantation alone or combined liver and heart transplantation[179].

In addition to the management of symptoms and the possibility of organ transplantation there are a number of drugs under investigation for ATTR amyloidosis. These medicines either target the production of the precursor protein, stabilise the tetramer or act to eliminate existing amyloid deposits (Figure 3.3). So different are their actions that it seems likely that with time these drugs may be used in combination.

Small interfering RNA (SiRNA) molecules bind to and silence messenger RNA sequences preventing protein formation. Patisiran (ALN-TTR02) has been found to reduce TTR production by greater than 80% in those with ATTRm[180]. Patisiran improved multiple clinical manifestations of hereditary transthyretin amyloidosis in a very recently published phase 3 study[65]. Importantly there were exploratory end points for cardiac response; NT-ProBNP and echocardiographic features of cardiac amyloidosis. There was a 55% reduction in mean baseline NT-

ProBNP ( $p < 0.01$ ) in the patisiran treated group and reduction in mean LV wall thickness ( $p = 0.02$ ) and improvement in longitudinal strain ( $p = 0.2$ ).

Inotersen is an antisense oligonucleotide that binds to RNA preventing translation resulting in a reduction in circulating TTR[181]. Despite safety issues with thrombocytopenia, the inotersen trial was continued and has shown improved neurological symptoms and quality of life in patients with hereditary transthyretin amyloidosis[168]. There was insufficient power to measure the effects on cardiac function. Both patisiran and inotersen have now been licensed for the treatment of Familial Amyloid Polyneuropathy.

Diflunisal is an old-fashioned nonsteroidal anti-inflammatory agent that stabilises the TTR tetramer in vitro by binding via the thyroid hormone receptor sites. There is little evidence of an effect in vivo and it is not an attractive agent given the risk of bleeding and water retention associated with its drug class[182, 183].

Tafamadis, 2-(3,5-dichloro-phenyl)-benzox-azole-6-carboxylic acid), also stabilises the TTR tetramer and prevents its dissociation. Recently a phase 3 study of 441 patients with transthyretin amyloid cardiomyopathy who had predominantly cardiac manifestations, of which 335 had ATTRwt. Tafamidis reduced all-cause mortality and cardiovascular-related hospitalizations and slowed the decline in functional capacity and in quality of life.[63].

Drugs that eliminate amyloid deposits are in earlier stages of development. PRX004 is a monoclonal antibody that binds to ATTR and activates phagocytosis[184]. The anti-SAP antibody and its use with CPHPC has already been discussed in Chapter 1. It should be noted that there is currently a clinical trial underway of a combination of the commonly prescribed antibiotic doxycycline in combination with tauroursodeoxycholic acid in ATTR amyloidosis (ClinicalTrials.gov Identifier: NCT03481972). Doxycycline has been found to disrupt amyloid fibrils in mice and this effect is enhanced by the addition of tauroursodeoxycholic acid in animal models[185]. In a study of 53 patients with

transthyretin cardiac amyloidosis, of which 89% had ATTRwt this combination of commonly used drugs led to stabilization of markers of disease progression and improvement in global strain rate in those with less advanced disease[186].

As new agents appear early diagnosis becomes more important as, by analogy with other types of amyloidosis, that it is widely accepted that earlier treatment, prior to established heart failure, is likely to be more efficacious both in terms of life expectancy and cardiac performance status.

We sought to identify cases in which TTR amyloid deposition was found in non-cardiac tissue biopsies leading to referral for investigation for systemic amyloidosis, and to determine the clinical significance of these amyloid deposits to inform the natural history of ATTRwt Amyloidosis.

**Figure 3.3: New therapeutic options under investigation in ATTRwt amyloidosis**

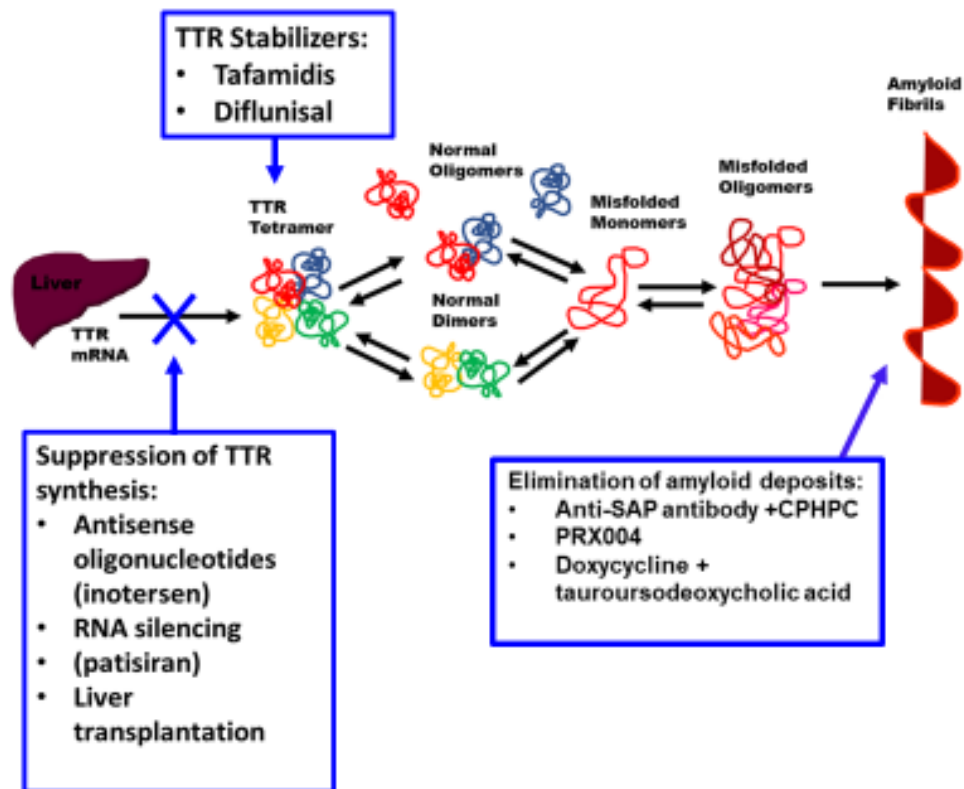

Figure depicting the mechanism of action of newly licenced and proposed treatments for ATTR amyloidosis.



## **Patients and Methods**

### **Patients:**

Retrospective analysis of the database of all histological specimens kept by the UK National Amyloidosis Centre (NAC) from 1998 – 2015. Cases were identified where TTR amyloid deposition was identified in a tissue of non-cardiac origin by either immunohistochemistry, proteomics or both.

### **Laboratory Procedures:**

Congo red binding and immunohistochemistry was performed on all samples at the NAC, irrespective of whether amyloid has been identified at the referring centre. Using standard techniques, formalin-fixed paraffin-embedded biopsy specimens were stained with Congo red and viewed under cross-polarized light [5]. Immunohistochemistry was performed using monospecific antibodies to the amyloid precursor proteins SAA, Kappa, Lambda and TTR[187]. In cases where amyloid was identified by Congo Red binding but immunohistochemistry was unable to identify the precursor protein, amyloid deposits were micro-dissected for proteomic analysis, as previously described [188].

In all cases genotyping was performed on DNA extracted from whole blood treated with EDTA [162]. Polymerase chain reaction was used to amplify coding exons 2, 3 and 4 of the TTR gene, which were then sequenced using standard techniques. All cases with genetic variants within the TTR gene were excluded from further analysis [189].

### **Clinical assessments and diagnostic procedures:**

All cases underwent a standardised diagnostic assessment at the NAC at first visit, consisting of clinical assessment, New York Heart Association Classification (NYHA), 6-minute walk test, serum cardiac biomarkers NT-Pro-BNP and Troponin T, electrocardiogram (ECG), echocardiogram, serum amyloid P component (SAP) scintigraphy (to exclude visceral amyloid deposits which would suggest other forms of systemic amyloidosis) and Tc-99 DPD scintigraphy.

ECG was performed according to standard protocol [190], Echocardiogram analysis was performed according to standard recommendations including the

measurement of wall thickness in centimeters, ejection fraction in percentage, and assessment of diastolic dysfunction using global strain rate and pattern [191].

Cardiac amyloidosis was defined using consensus criteria validated in AL amyloidosis due to the absence of published criteria in cardiac TTR amyloidosis, these same criteria are used clinically [192]. Cardiac Amyloidosis was diagnosed in the presence of a positive non-cardiac biopsy if there were echocardiographic features of amyloidosis; mean left ventricular wall thickness (septum and posterior wall) of greater than 12 mm (in the absence of hypertension or other potential causes of left ventricular hypertrophy), right ventricular free wall thickening in the presence of left ventricular thickening and in the absence of pulmonary or systemic hypertension, doppler echocardiographic evidence of diastolic dysfunction with abnormalities in strain echocardiography.

The presence of low voltage of less than 5 mm in all limb leads on a 12-lead ECG is suggestive of but not specific for cardiac involvement by amyloid [193], similarly elevations of the serum cardiac biomarkers Troponin T and NT-Pro BNP are suggestive but not specific [194, 195]. However, myocardial amyloid is excluded by normal values of NT-Pro BNP (<332 ng/L) [196].

SAP scintigraphy was performed using radiolabelled <sup>123</sup>Iodide imaged using a gamma camera to exclude other systemic amyloidosis [197]. <sup>99m</sup>Tc-DPD scans were performed using 700 MBq of <sup>99m</sup>Tc-DPD and whole-body planar images acquired by gamma camera [164]. Cardiac retention of <sup>99m</sup>Tc-DPD was scored by nuclear medicine radiologists using the Perugini grading system [37].

All patients provided written informed consent approved by the Royal Free Hospital Ethics Committee.

### **Statistical Analysis:**

Age at presentation and diagnosis was expressed as median (Q1, Q3). Proportions of patient cohort were expressed as percentage values. Survival was assessed as months from first attendance at NAC (first presentation) to date of

ensor (01/03/2017) or death. Mann-Whitney U test and Kaplan-Meier survival analysis were performed using GraphPad Prism version 5.00 for Windows, GraphPad Software, San Diego California USA.

## **Results**

### **Cohort Characteristics**

25 cases were identified where tissue taken from a non-cardiac site revealed TTR amyloid deposition, they had no mutation in the TTR gene and the biopsy was the reason for referral to the NAC ie no previously known or suspected amyloidosis (Table 4). Median age at presentation was 79.39 years (75.56, 84.65). 92 % (23/25) were male. All individuals were of European ancestry, 22 were of white British origin, one was Polish, one American and one Greek Cypriot.

The biopsy sites were bladder (n=13) duodenum (n=3), bone marrow (n=2), colon (n=1), stomach (n=1), lung (n=1), tenosynovium (n=2), prostate (n=1), muscle (n=1). 23/25 were typed as TTR using immunohistochemistry, in 2 cases proteomics was required to confirm the precursor protein type. In 9 cases we received subsequent tissue samples from other areas (gallbladder (TTR), Nerve (No amyloid), Endomyocardial biopsy (TTR), Rectum (TTR), Liver (amyloid with no immunospecific stain, NISS), Bone Marrow (Amyloid NISS in one case, No evidence of amyloid in 2 cases). In all cases SAP scintigraphy was negative as would be expected in ATTRwt amyloidosis.

**Table 3.2: Baseline demographics and histopathology and presence of cardiac involvement**

Case No.	Gender	Age at presentation (years)	Mode of presentation	Biopsy Site	Biopsy Result	Evidence of Cardiac Amyloid at Presentation†	Evidence of Cardiac Amyloidosis at Presentation‡	Other biopsy sites	Other Biopsy site Histology	Other clinical features of Systemic TTR Amyloidosis at presentation
1	M	82.10	Frank Haematuria	Bladder	TTR	Y	Y	Rectum	Amyloid TTR	Bilateral CTS
2	M	82.39	Microscopic Haematuria	Bladder	TTR	Y	N	Bone Marrow	No Amyloid	Bilateral CTS
3	M	73.68	Frank Haematuria	Bladder	TTR	Y	Y	Bone Marrow	Amyloid NISS	Bilateral CTS Spinal Stenosis
4	M	81.51	Frank Haematuria	Bladder	TTR	Y	Y	-	-	-
5	M	78.25	Frank Haematuria	Bladder	TTR	Y	Y	-	-	-
6	M	70.86	Frank Haematuria	Bladder	TTR	Y	Y	Myocardium	Amyloid TTR	-
7	M	78.45	Frank Haematuria	Bladder	TTR	Y	Y	-	-	-
8	M	86.22	Frank Haematuria	Bladder	TTR	Y	Y	Abdominal fat pad	No Amyloid	-
9	M	85.02	Frank Haematuria	Bladder	TTR	Y	Y	-	-	Bilateral CTS
10	M	85.98	Frank Haematuria	Bladder	TTR	Y	N	-	-	-
11	M	71.32	Frank Haematuria	Bladder	TTR	Y	Y	-	-	Bilateral CTS

12	M	77.73	Frank Haematuria	Bladder	TTR	Y	N	-	-	-
13	M	72.96	Routine TCC follow up	Bladder	TTR	Y	Y	-	-	Unilateral CTS
14	M	79.39	Ix of known paraprotein	Bone marrow	TTR	N	N	-	-	-
15	F	85.19	Ix of known paraprotein	Bone marrow	TTR	Y	N	Liver	Amyloid NISS	Bilateral CTS
16	M	70.63	Gastrointestinal Bleeding	Stomach	TTR	N	N	-	-	-
17	M	77.61	Ix of Dyspepsia	Duodenum	TTR	Y	Y	Gall Bladder Bone Marrow	Amyloid TTR No Amyloid	Bilateral CTS
18	M	83.37	Investigation of anaemia	Duodenum	TTR	Y	N	-	-	Unilateral CTS
19	M	85.31	Ix of anaemia	Duodenum	TTR	Y	Y	-	-	-
20	M	81.86	Diahorrea	Colon	TTR	Y	Y	-	-	bilateral thenar wasting (suggestive CTS)
21	M	77.44	Neuropathy and Lung lesion on CXR	Lung	TTR	N	N	Nerve	No Amyloid	-
22	M	84.28	Frank Haematuria, LUTS	Prostate		N	N	-	-	-
23	M	78.80	Ix of known paraprotein	Muscle		Y	Y	-	-	-
24	F	86.70	Carpal Tunnel Syndrome	Carpal Tunnel		Y	Y	Abdominal Fat Pad		Bilateral CTS
25	M	73.64	Carpal Tunnel	Carpal Tunnel		Y	Y	-	-	Bilateral CTS

			Syndrome							
--	--	--	----------	--	--	--	--	--	--	--

Table 1 legend: Ix Investigation, TTR Transthyretin, CXR Chest X –ray, CTS carpal tunnel syndrome, M male, F female, Y Yes, N No, †Cardiac amyloid diagnosed as presence of DPD uptake or positive endomyocardial cardiac biopsy plus or minus evidence of cardiac amyloidosis ‡Cardiac amyloidosis is clinically overt and diagnosed by author consensus, defined in methods.

## Cardiac Investigations

84% (21/25) had evidence of cardiac amyloid and 64% (16/25) fulfilled criteria for cardiac amyloidosis at presentation, (Table 3.3). NT-ProBNP and Troponin T were elevated in all cases with cardiac amyloidosis except cases 24 and 25 who presented with carpal tunnel syndrome but had relatively normal values for their age and renal function. Of those with cardiac amyloid or amyloidosis at presentation (n=21) the most frequent ECG abnormality was atrial fibrillation. Only 5 had what is regarded as characteristic low voltage complexes in the limb leads. There was evidence of cardiac uptake on <sup>99m</sup>Tc-DPD scintigraphy in 18 of the 21 with cardiac amyloid at presentation, the remaining three cases were not scanned as they presented prior to the scans being routinely available at the centre. Two patients underwent <sup>99m</sup>Tc-DPD scanning 2- and 4-years following presentation due to the advent of the imaging technique. 5 cases had Perugini Grade 1 uptake at presentation, none of these had evidence of clinically significant amyloidosis and none of these progressed over the follow up period (median 52months (31,57)) and two died; one from intracerebral haemorrhage and one from cause unknown. 10 cases had Grade 2 uptake and 3 with Grade 3, all had evidence of cardiac amyloidosis at presentation. Table 3.4 summarises the cardiac involvement, progression, follow up and survival.

All those with TTR deposits in the bladder (n=13) had evidence of cardiac involvement and 10 (77%) had cardiac amyloidosis. 6 of these had normal echocardiograms, but all had elevated cardiac biomarkers and cardiac uptake on <sup>99m</sup>Tc-DPD scintigraphy where scanned (n=10). Two were NYHA Class I and 9 were NYHA Class II at presentation.

48% of the cohort had a history of carpal tunnel syndrome and or decompression surgery at presentation. In all cases with a history of carpal tunnel syndrome (n=12) cardiac amyloid was detectable by <sup>99m</sup>Tc-DPD scintigraphy at presentation, and 9 had evidence of cardiac amyloidosis. One case had TTR amyloid found in bladder tissue, amyloid deposition in the bone marrow, bilateral carpal tunnel syndrome and a history of spinal stenosis, he was alive at censor after 80 months of follow up.

**Table 3.3: Assessment of cardiac function**

Case Number	NYHA Class	6 minute walk test (metres)	NT-Pro BNP (ng/L)	Troponin T (ng/L)	Echo Characteristic of cardiac amyloidosis	LVS (cm)	ECG	<sup>99m</sup> Tc-DPD Cardiac Uptake	Evidence of Cardiac Amyloid at Presentation †	Evidence of Cardiac Amyloidosis at Presentation ‡
1	II	168	9252	59	Y	1.7	AF	3	Y	Y
2	III	no data	1615	59	N	1.0	SR, RBBB	1	Y	N
3	II	no data	2317	59	Y	1.5	AF	2	Y	Y
4	II	no data	2140	-	N	1.3	AF	2*	Y	Y
5	III	no data	13362	40	Y	1.5	AF	No Scan	Y	Y
6	II	no data	4186	50	Y	1.7	AF, RBBB, low voltage complexes	No Scan	Y	Y
7	II	no data	5438	84	Y	1.6	sinus, low voltage	3	Y	Y
8	II	no data	5412	40	Y	1.9	AF	No Scan	Y	Y
9	II	no data	3121	46	Y	2.1	AF, low voltage complexes, pseudo infarct pattern	2	Y	Y
10	I	no data	829	21	N	1.0	SR LAD poor R-wave progression	1	Y	N
11	II	22	2579	48	N	1.6	AF, LAD	2	Y	Y
12	II	339	1023	15	N	1.0	AF	1	Y	N
13	I	337	2199	45	Y	1.5	SR low voltage complexes	2**	Y	Y
14	I	No data	1768	45	N	1.1	SR	0	N	N
15	II	444	126	12	N	1.0	SR	1	Y	N
16	II	no data	355	10	N	1.3	AF interventricular conduction delay	0	N	N



17							SR 1st degree AV block, Low voltage complexes			Y
	II	no data	482	53	Y	1.4		2	Y	
18	III	no data	618	27	N	1.2	low voltage complexes	1	Y	N
19	II	351	1447	32	Y	1.4	SR	2	Y	Y
20	II	no data	888	-	Y	1.6	AF	3	Y	Y
21	Not recorded	no data	25	25	N	0.8	SR	0	N	N
22							AF T wave inversion in lateral leads			N
	II	396	668	17	N	1.2		0	N	
23	II	219	24618	159	Y	1.9	AF RBBB	2	Y	Y
24	II	46	203	59	Y	1.3	NSR	2	Y	Y
25	I	506	169	27	N	1.4	SR	2	Y	Y

- no result available, NT-ProBNP normal range < 332ng/L, Troponin T normal range < 15ng/L, SR sinus rhythm, AF atrial fibrillation, RBBB right bundle branch block, LAD left axis deviation, \*performed 4 years after presentation \*\*performed 8 years after presentation, †Cardiac amyloid diagnosed as presence of DPD uptake or positive endomyocardial cardiac biopsy plus or minus evidence of cardiac amyloidosis ‡Cardiac amyloidosis diagnosed by author consensus, defined in methods.

**Table 3.4: Summary of cardiac involvement, progression, follow up and survival**

Case Number	Duration of follow up (months)	<sup>99m</sup> Tc-DPD Cardiac Update	Evidence of Cardiac Amyloid at Presentation†	Evidence of Cardiac Amyloidosis at Presentation‡	Evidence of cardiac progression during follow up	Status at Follow up	Cause of Death
1	54.08	3	Y	Y	N	Alive	-
2	52.90	1	Y	N	N	Alive	-
3	80.05	2	Y	Y	Y	Alive	-
4	64.34	2*	Y	Y	Y	RIP	Not recorded
5	15.06	No Scan	Y	Y	N	RIP	UTI
6	176.52	No Scan	Y	Y	Y	Alive	-
7	47.51	3	Y	Y	Y	RIP	UTI
8	45.11	No Scan	Y	Y	Y	RIP	CCF
9	27.02	2	Y	Y	N	RIP	Cardiac amyloidosis
10	60.07	1	Y	N	N	Alive	-
11	23.44	2	Y	Y	N	RIP	Cardiac amyloidosis
12	16.57	1	Y	N	N	RIP	Stroke
13	115.50	2**	Y	Y	Y	RIP	Neoplasm
14	57.34	0	N	N	N	Alive	-
15	47.24	1	Y	N	N	Alive	-
16	75.98	0	N	N	N	Alive	-
17	51.98	2	Y	Y	N	Alive	-
18	55.56	1	Y	N	N	RIP	Not recorded
19	33.14	2	Y	Y	Y	Alive	-
20	47.90	3	Y	Y	Y	RIP	Not recorded
21	18.05	0	N	N	N	RIP	NHL
22	34.09	0	N	N	N	Alive	-
23	17.79	2	Y	Y	N	Alive	-
24	27.58	2	Y	Y	Y	Alive	-
25	48.59	2	Y	Y	Y	Alive	-

\*performed 4 years after presentation \*\*performed 8 years after presentation †Cardiac amyloid diagnosed as presence of DPD uptake or positive endomyocardial cardiac biopsy plus or minus evidence of cardiac amyloidosis ‡Cardiac amyloidosis diagnosed by author consensus, defined in methods. UTI urinary tract infection, CCF congestive cardiac failure, NHL Non Hodgkins Lymphoma.

## Survival

Median follow-up for the whole cohort was 47.90 months (27.30, 58.71) to death or censor (Table 3.3). Median survival was 64.34 months (Figure 11). 11 (44%) were deceased by time of censor, with mean age at death of 83 years and median follow up of 45.11 months (18.05, 55.56). Cause of death was recorded in eight of the eleven with single organ amyloidosis or congestive cardiac failure as cause of death in three cases. Of note, 2 with amyloid identified in the bladder died as a consequence of urinary tract infection.

Of the whole cohort, those without any evidence of cardiac amyloid at presentation (n=4) did not develop cardiac amyloidosis over time (median follow up 46 months (22, 71)), one died from unrelated Non-Hodgkin's lymphoma 18 months into follow-up.

10 cases had evidence of progression of cardiac amyloidosis by echocardiography with median follow-up of 48.25 months (42.12, 88.91). All cases who progressed had evidence of cardiac amyloidosis at presentation. Of the 11 who did not progress, median follow-up was comparable 47.24 (17.79, 54.08), Mann-Whitney U test P= 0.13.

**Figure 3.3: Kaplan–Meier survival from diagnosis in patients with TTR identified in non-cardiac tissue**

Figure showing survival from diagnosis of amyloid in those with TTR amyloid identified from non-cardiac biopsies.

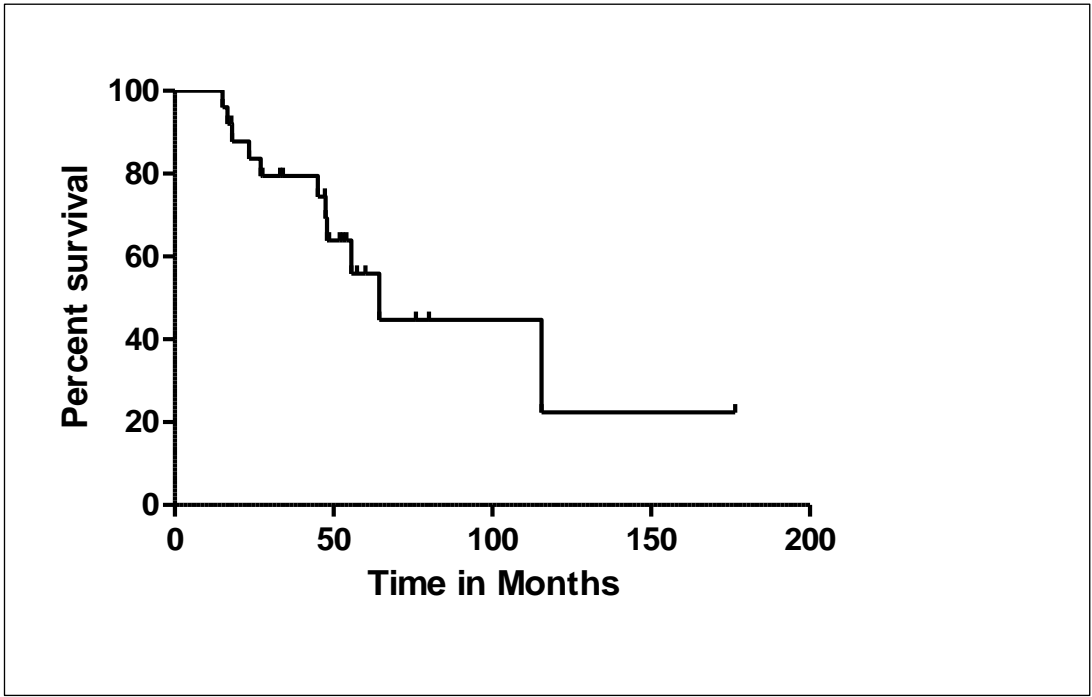

## Discussion

TTR amyloid deposits can be readily identified in a myriad of tissues. This cohort demonstrates that when TTR is found in non-cardiac tissue it is likely that there is co-existent cardiac amyloidosis, which can be readily identified by  $^{99m}\text{Tc}$ -DPD scintigraphy. This study is limited by its small size (n=25) and retrospective design, however, this is a rarely diagnosed disease and of note the largest published cohorts only describe 102 and 108 patients respectively [10, 198].

In our study in 64% of cases the finding of TTR amyloid deposits in non-cardiac tissue led to the diagnosis of cardiac amyloidosis highlighting the fact that amyloid identified histologically must be typed and the patient fully assessed for organ dysfunction. However, not all TTR amyloid deposition is clinically significant, and we saw no evidence of cardiac amyloid deposition over time in those who did not have evidence of it at presentation. Similarly, in those with no evidence of cardiac amyloidosis but cardiac amyloid deposition only at presentation (ie all cases with grade 1  $^{99m}\text{Tc}$ -DPD scintigraphy), none showed evidence of progression to cardiac dysfunction over time. In keeping with the wider ATTRwt cohort there was no difference between the outcomes of those with Perugini grade 2 or grade 3 cardiac uptake [39].

Median survival was 64.34 months from first presentation. This is in contrast to the median diagnosis of the whole ATTRwt cohort which is 32.52 months from diagnosis [10]. However, median survival of the whole ATTRwt cohort from symptom onset is 77.84 months. This could suggest a poorer prognosis for those who present following a non-cardiac biopsy but there are many other explanations, such as the possibility that those with seemingly silent cardiac disease are frailer or less mobile and thus less symptomatic. The study numbers are small, and a larger series is needed to draw firm conclusions.

The *in vivo* mechanism for TTRwt amyloidogenesis remains incompletely understood. Mutations in the TTR gene have been identified that are more readily amyloidogenic (Ser52Pro) [167] and one that appears to be protective *in vitro* (Thr119Met) but the mechanism of why those with a wild-type gene go on to develop TTR amyloid deposits is incompletely known [199]. Recently a novel sheer stress mechanism was described that causes cleavage of the TTR

molecule leading to amyloid fibril formation [11]. This is interesting given the observation that many patients with ATTRwt amyloidosis were previously unusually athletic or performed physically demanding jobs. Similarly, identifying early features of the disease, such as carpal tunnel syndrome, may identify individuals at risk of developing cardiac ATTR amyloidosis [62].

The data herein shows that when TTR amyloid deposits are found in tissues outside the heart it is mandatory to assess the patient for cardiac amyloidosis and that even subclinical disease can be readily identified using a combination of newer imaging modalities and serum biomarkers. A history of atrial fibrillation and carpal tunnel syndrome is suggestive of cardiac amyloidosis.

The data suggest that if there is no evidence of cardiac involvement at presentation with TTR amyloid outside of the heart then it may not inevitably develop. The data also suggest that progression of cardiac ATTR amyloidosis is not only dependent on duration, with the same follow-up duration in both groups ( $P=0.13$ ). It is interesting that all those with bladder TTR amyloid had evidence of cardiac amyloid (even in the one case who was asymptomatic from a urological perspective but TTR amyloid was found on routine surveillance cystoscopic biopsy for previous cancer). In addition, all those with a history of carpal tunnel syndrome had cardiac amyloid deposition, and both individuals with carpal tunnel biopsies positive for TTR (cases 24 and 25) had cardiac amyloidosis, in keeping with our broader experience of ATTRwt where 98% of those attending the NAC have evidence of median nerve entrapment on neurophysiological studies and 48% have had a history of carpal tunnel decompression as much as 12 years prior to their typical presentation with advanced heart failure symptoms [10]. These two findings suggest that bladder involvement may be a late manifestation of ATTRwt, after amyloid has been deposited in the heart, whereas carpal tunnel syndrome may be earlier in the disease course and can exist prior to the development of cardiac amyloid or amyloidosis.

The case series described is small but suggests that nerve, muscle and bone marrow deposition may occur without progression to amyloidosis or early in the disease course, whereas bladder deposition was seen exclusively with cardiac deposition, even in the asymptomatic, suggesting that it may occur late as a

consequence of systemic ATTRwt amyloidosis (perhaps via a different mechanism).

This study is further limited by the fact that the extent to which TTR amyloid deposition occurs naturally in tissues is not known. It is also limited by its relatively short duration. Lifelong follow up of this cohort will help to determine whether TTR amyloid deposition in tissues inevitably leads to systemic cardiac ATTRwt amyloidosis given sufficient time.

## **Chapter Four:**

### **Carpal tunnel biopsy as a diagnostic tool to identify early cases of cardiac transthyretin amyloidosis**



## **Introduction**

In the previous chapter the significance of transthyretin amyloid deposits in non-cardiac tissue was explored. In two cases transthyretin amyloid was identified in tissue taken during carpal tunnel decompression surgery.

Carpal tunnel syndrome (CTS) is the most common entrapment neuropathy of the upper limb with a prevalence of between one and five percent in European populations [200]. The syndrome results from disruption of the median nerve as it passes through the carpal tunnel, an anatomical space bounded by the bones of the carpus and the transverse carpal ligament[201]. Physiological pressure within the carpal tunnel ranges from 2-31mm Hg, a wide range of normal due to increases in pressure caused by movements at the wrist and fingers, however, in those with carpal tunnel syndrome measured pressure within the tunnel is elevated to between 32-110mmHg[202]. The increased pressure is thought to impair microvascular circulation in the median nerve and ultimately compromises its function. Thus, any condition or circumstance that leads to narrowing of the carpal tunnel or swelling of its contents can lead to carpal tunnel syndrome.

There are two peaks in incidence of CTS; the first in the late 50's with a large female predominance and the second is in the late 70s with equal distribution between men and women[203].

Presenting symptoms are characteristically altered sensation of the thumb, index and middle finger, with pain and paraesthesia in this distribution (Figure 4.1). The condition can result in pain and weakness in the muscles supplying the thumb and forefingers and as such it incurs considerable employment and healthcare costs[201].

**Figure 4.1: The Carpal Tunnel Syndrome; anatomy and surgical decompression**

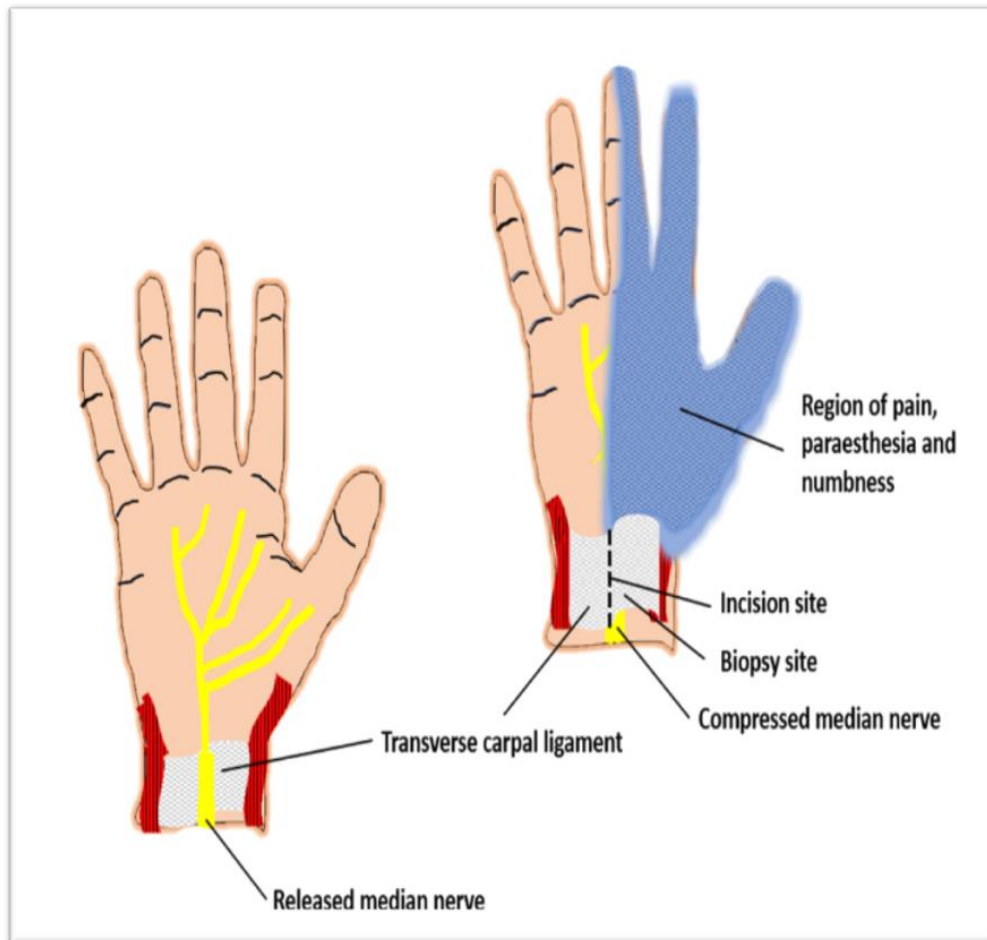

The blue area depicts the area supplied by the median nerve. Carpal tunnel decompression is performed along the dashed line (marked incision site). This releases the pressure on the median nerve and is effective in relieving symptoms.

Carpal tunnel syndrome often presents unilaterally but neurophysiological studies have shown that it is a bilateral syndrome in the majority of cases even if it is not clinically apparent[204]. The National Institute for Health and Care Excellence (NICE) outlines the current recommendations for treatment of this syndrome; lifestyle modifications, wrist splinting in a neutral position (especially at night) and corticosteroid injection into the carpal tunnel[205]. If symptoms are significant and nerve conduction studies identify severe latency of the median nerve conduction, or in the case of moderate disease, if symptoms are refractory to standard treatment (splinting and steroid injection) referral for surgery is advised. At carpal tunnel decompression surgery typically the

compression of the median nerve is released by open transection of the transverse carpal ligament but it may also be performed endoscopically through a one or two port approach[206].

There are a number of well recognized causes of carpal tunnel syndrome but most commonly it is considered idiopathic with no clear cause identified (Table 4.1).

**Table 4.1: Commonly recognised causes of Carpal Tunnel Syndrome**

Idiopathic (Most common cause)	Obesity	Pregnancy	Diabetes mellitus	Hypothyroidism
Wrist Fracture	Inflammatory arthritis	Osteoarthritis Overuse of hand or wrist Use of vibrating tools	Medications (Particularly aromatase inhibitors[207])	Genetic (Higher familial incidence seen in twin studies[208])

However, carpal tunnel syndrome is the most well recognised early clinical manifestation of systemic transthyretin amyloidosis[10]. In our cohort 98% of those with proven cardiac ATTR Amyloidosis had evidence of median nerve entrapment on neurophysiological studies and 48% had a history of carpal tunnel decompression as much as 12 years prior to clinical presentation with advanced heart failure symptoms[10].

As previously stated ATTRwt is currently diagnosed in approximately 150 individuals in the UK annually but cadaveric studies suggest the disease prevalence of ATTRwt may be as much as 30% in those over 80 years[169, 170]. A more recent study has shown that 13% of those admitted to hospital with decompensated heart failure symptoms but preserved ejection fraction and an LV wall thickness >1.2 cm on echocardiography have ATTR amyloidosis[171]. This is further supported by a >50fold increase in the number of referrals to the UK NAC since 2000, corresponding with increasing awareness of the disease as well as the more widespread use of cardiac MRI scans which can more readily identify cardiac amyloidosis than echocardiogram [209].

As described in the previous chapter,  $^{99m}\text{Tc}$ -DPD has become a highly sensitive tool for the diagnosis of cardiac ATTR amyloidosis and now largely abrogates the need for cardiac biopsy, identifying cardiac ATTR amyloidosis with a sensitivity of 98% and specificity of 70%[40]. Thus, if TTR amyloid deposits are identifiable within the carpal tunnel years before cardiac symptoms arise, and  $^{99m}\text{Tc}$ -DPD can detect even pre-symptomatic cardiac ATTR amyloidosis, we may be able to diagnose ATTRwt amyloidosis at an earlier, perhaps more treatable, stage using these techniques in combination.

This is now of increasing importance given very recent licensing of patisiran, inotersen and tafamidis [63-65]. Analogous to other types of amyloidosis, it is anticipated that earlier treatment of ATTRwt, prior to established heart failure, is likely to be more efficacious both in terms of life expectancy and cardiac performance status.

It is well established that immunohistochemistry is readily able to identify TTR amyloid deposits in a myriad of tissues including that derived from the carpal tunnel at decompression surgery. The prevalence of amyloid deposition within the symptomatic carpal tunnel has previously been investigated in several studies. In 1975, Stein *et al* initially described a 19% prevalence of amyloid deposition within 140 carpal tunnel biopsies from 108 patients with carpal tunnel syndrome collected over 11 years from a single centre in Germany [210]. 62.96% were identified as TTR (known then as pre-albumin), with the other amyloid types AA, AL and  $\beta$ 2 microglobulin also identified.

Nakamichi and Tachibana have reported a prevalence of amyloid in the symptomatic carpal tunnel of 9.26%(10 of 108 individuals undergoing carpal tunnel biopsy) in a Japanese cohort with a mean age of 56 years and 80% female [211]. In this study two cases were identified as TTR with strong immunostaining and a further four cases showed weak staining with TTR. Proteomic analysis was not available in 1996. The cohort was followed-up for a mean of 12.5 years (range 4.5-25 years) from symptoms onset and a mean of 4.5 years (range 3-6 years) following surgery, no cases developed symptoms or signs of cardiac amyloidosis during the follow-up period. In a more recent study by Sekijima *et al* 34.0% of 100 patients with idiopathic carpal tunnel syndrome showed amyloid deposition in the tenosynovial tissue[172]. All

identified amyloid deposits were immunophenotyped as TTR. DNA sequencing of the transthyretin gene did not reveal any mutations. Analysis of the cohort identified age and male sex as independent risk factors for transthyretin amyloid deposition. These studies all predate the use of  $^{99m}\text{Tc}$ -DPD as a non-invasive technique with the ability to identify even clinically silent TTR amyloidosis.

It is not known whether amyloid deposition contributes to the pathology of carpal tunnel syndrome. There have been no histopathological studies looking for amyloid deposits in the healthy carpal tunnel.

We sought to identify; (i) the prevalence of amyloid deposition as TTR in the local population with idiopathic carpal tunnel syndrome, (ii) to investigate the prevalence of cardiac amyloidosis at carpal tunnel surgery in those with amyloid deposits, and (iii) to determine whether clinically silent amyloidosis could be identified in this cohort using  $^{99m}\text{Tc}$ -DPD scintigraphy.

**Methods:**

Carpal tunnel biopsies were taken at routine decompression surgery from individuals referred to a single operative surgeon at the Royal Free Hospital NHS Foundation Trust, London. Cases were selected at random in those in whom carpal tunnel syndrome was considered idiopathic. A small sample of tissue was taken from the volar aspect of the transverse carpal ligament after incision of the ligament to compress the carpal tunnel. This tissue was put in formalin and sent for analysis for amyloid to the histopathology laboratory at the NAC.

Biopsies were stained with Congo red and viewed under cross polarised light using standard technique as detailed in Chapter two. Immunohistochemistry was used to type amyloid deposits using standardised techniques described in methods. Proteomic analysis was performed in cases where amyloid could not be readily typed using immunostaining as detailed in Chapter two.

Age at biopsy was expressed as mean. Proportions of patients were expressed as percentage values. Statistical analysis was performed using GraphPad Prism version 5.00 for Windows, GraphPad Software, San Diego California USA.

## **Results:**

### **Whole Cohort Characteristics:**

Biopsies were taken on 60 patients undergoing routine carpal tunnel decompression surgery between January 2015 and April 2017 by a single operating surgeon on those, where no cause for their entrapment neuropathy was identifiable from the clinical history. There were no surgical complications from the biopsy being taken.

60% of the whole biopsy cohort were female (n=36). Mean age at biopsy 77.65 years (range 21.99-86.83 years). 16.7% of biopsies contained evidence of amyloid. The cohort in which amyloid was found was older, mean age at biopsy was 81.85 years compared to 57.90 years in the group in which no amyloid was found (p=0.0092) (Table 4.2). Table 4.3 depicts the characteristics of those with amyloid identified in the carpal tunnel.

Seven (11.67%) biopsies demonstrated definitive staining with TTR (cases 1,2,3,6,8,9,10). Two biopsies (cases 4 and 5) showed amyloid but this did not stain with monospecific antibodies reactive with serum amyloid A, transthyretin nor kappa or lambda light chains (termed NISS). Proteomics was performed on these samples and no amyloid signature proteins were identified. Case 4 declined assessment. Case 5 was referred to the NAC and was found to have an IgG Kappa paraprotein of 4g/L and was on long term dialysis for hypertensive chronic kidney disease. Full assessment including SAP scintigraphy revealed no visceral amyloid deposition and the amyloid deposits were assumed to be  $\beta$ 2microglobulin.

In one further sample amyloid was suspected due to positive Congo red binding and characteristic fluorescence but the sample was too small to type (TSTT). This patient (case 7) was referred to the NAC for assessment and all investigations were negative for amyloidosis.

**Table 4.2: Whole cohort characteristics**

Result	Number	Mean age at biopsy (years)	Percentage female
No amyloid	50	57.90	58%
Amyloid	10	81.85	60%
Whole cohort	60	p=0.0092*	-

\*Two tailed T-test

**Table 4.3: Characteristics of cohort with amyloid identified in the carpal tunnel**

Patient Number	Gender	Age at biopsy (years)	Congo Red Result	Immunohistochemistry result	Proteomics result
1	Female	80.3	Positive	TTR	Not done
2	Male	76.4	Positive	TTR	Not done
3	Female	86.8	Positive	TTR	TTR
4	Female	74.9	Equivocal	NISS	NASP
5	Male	83.7	Positive	NISS	NASP
6	Female	83.8	Positive	TTR	Not done
7	Male	57.4	Positive	TSTT	NASP
8	Male	69.7	Positive	TTR	TTR
9	Female	84.9	Positive	TTR	Not done
10	Female	83.4	Positive	TTR	Not done
	60% Female	Median: 81.9			

TTR transthyretin, TSTT too small to type, NISS amyloid with no specific immunostain (amyloid is present but did not stain immunospecifically with monospecific antibodies reactive with serum amyloid A, transthyretin and kappa and lambda light chains), NASP no amyloid signature proteins. Proteomics was initially only performed in cases where the immunohistochemistry result was uncertain or as part of another study.



**Table 4.4: Characteristics of those with TTR deposition in the carpal tunnel**

	<b>Gender</b>	<b>Age at biopsy (years)</b>	<b>Assessment at NAC</b>
<b>1</b>	<b>Female</b>	<b>80.3</b>	<b>Declined</b>
<b>2</b>	<b>Male</b>	<b>76.4</b>	<b>Yes</b>
<b>3</b>	<b>Female</b>	<b>86.8</b>	<b>Not yet</b>
<b>6</b>	<b>Female</b>	<b>83.8</b>	<b>Declined</b>
<b>8</b>	<b>Male</b>	<b>69.7</b>	<b>Yes</b>
<b>9</b>	<b>Female</b>	<b>84.9</b>	<b>Not yet</b>
<b>10</b>	<b>Female</b>	<b>83.4</b>	<b>Not yet</b>
<b>N=7</b>	<b>Female = 71%</b>	<b>Median 81.9 years</b>	<b>29%</b>

Of those with TTR amyloid within the carpal tunnel (n=7), there was a higher proportion of females (71%). The median age was 81.9 years. All have been referred to the NAC for evaluation. Table 4.4 lists their characteristics. Two declined this assessment and three are awaiting assessment at time of censor. Two underwent full assessment. Neither individual had symptoms or echocardiographic features of cardiac amyloidosis. Case 2 had a slightly raised NT-ProBNP (186 ng/L) and possible early uptake on the SPECT done at <sup>99m</sup>DPD scintigraphy (see case vignette 2). There has been no progression over two years of follow-up and he will continue to be assessed every two years. Case 8 was also assessed at the NAC. Interestingly, a mutation, Gly6Ser was found in exon 2 of his TTR gene. This mutation causes a codon change GGT>AGT and has been previously described and not considered amyloidogenic[212]. All investigations were normal and no cardiac amyloidosis detected (Table 4.5). However, he was already under cardiology review for unexplained syncope and had an implantable event recorder at time of assessment precluding cardiac MRI. He will be reassessed at the NAC in 2022.

**Table 4.5: Cardiac assessment of those with ATTR in the carpal tunnel**

<b>Investigation</b>	<b>Case 2 Male 76.4 years</b>	<b>Case 8 Male 69.7 years</b>
<b>Amyloid Type</b>	TTR	TTR
<b>TTR genotype</b>	Wild Type	Gly6Ser
<b>Clinical Assessment</b>	Euvolaemic NYHA I	Euvolaemic NYHA 1
<b>6-minute walk test (metres)</b>	391	584
<b>% predicted</b>	80	114
<b>NT-ProBNP (ng/L)</b>	186	<50
<b>Troponin T (µg/L)</b>	10	11
<b>ECG</b>	1 <sup>st</sup> degree heart block	Sinus rhythm
<b>Echocardiogram Impression</b>	Not suggestive of amyloidosis	Not suggestive of amyloidosis
<b>LVS (mm)</b>	11	9
<b>LVPW (mm)</b>	10	9
<b>LVEF (%)</b>	59	9
<b>Global strain (%)</b>	-23.7	-20.3
<b>99mTcDPD scintigraphy (Perugini grade)</b>	0 (Possible intraventricular wall uptake on SPECT see case Vignette 2)	0
<b>Cardiac MRI</b>	Declined	Contraindicated due to implantable recording device for recurrent syncope
<b>Follow-up duration</b>	2 years	Awaiting follow-up
<b>Progression</b>	No	n/a

## **Case Vignettes**

Two cases illustrate the ability to identify cardiac amyloidosis in a patient in whom TTR amyloid has been identified in a biopsy from a carpal tunnel.

### **Case 1**

This is the index case which informed the design of, but is not included in, this study.

An 86-year-old female of European ancestry presented with classical symptoms of carpal tunnel syndrome. Electrophysiological studies confirmed severe latency of the median nerve and she underwent right-sided carpal tunnel decompression at the Royal Free Hospital NHS Foundation Trust, London, at which time a biopsy was taken from the transverse carpal ligament. The tissue was analysed at the NAC and amyloid deposits were identified. Immunohistochemical staining demonstrated the amyloid deposits were of the transthyretin type. The patient was then referred to the NAC for further evaluation. She described a recent hospital admission for unexplained dyspnea. Echocardiography showed normal systolic function but impaired global strain rate (−15.7%) and a strain pattern consistent with cardiac amyloidosis. The intraventricular septum was thickened. <sup>99m</sup>Tc-DPD revealed Perugini Grade 1 uptake of tracer. Gene sequencing revealed no mutations in the transthyretin gene. Wild-type ATTR (ATTRwt) amyloidosis was diagnosed. Figure 4.2 shows the investigations pertinent to the case.

Figure 4.2: Investigations of Case 1 revealing TTR amyloid in the carpal tunnel biopsy and cardiac amyloidosis on  $^{99m}\text{Tc}$ -DPD

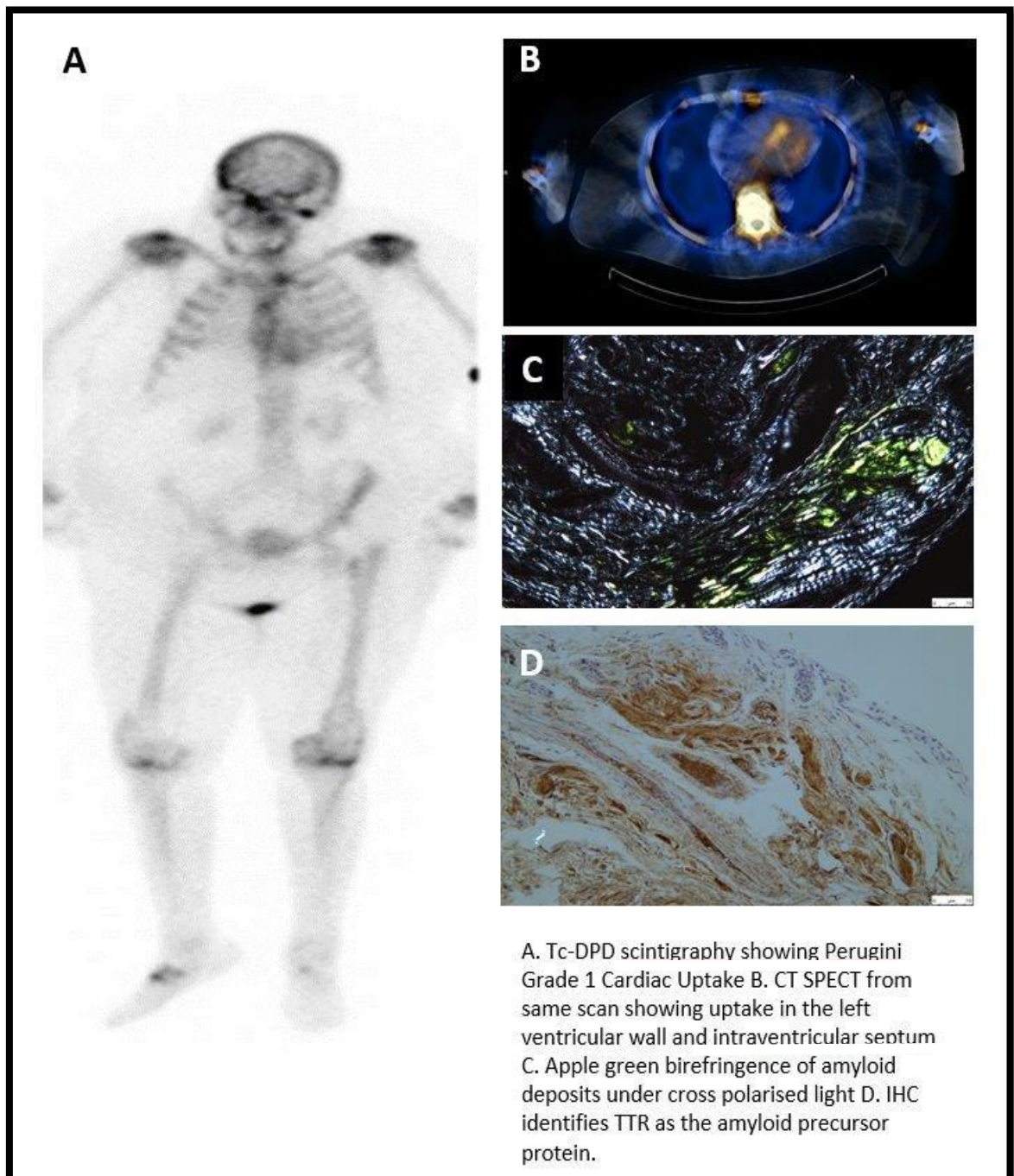

### Case 2:

This case is also referred to as case number 2 in the results section of this chapter.

A 76-year-old male of European ancestry underwent unilateral carpal tunnel decompression surgery on the right-hand side. Based on the surgeon's experience with Case 1 above, a 3mm biopsy was taken at surgery from the transverse carpal ligament. The biopsy was sent to the NAC for histology. This revealed amyloid (Figure 4.3) identified by Congo Red binding (Image A) and demonstrated apple green birefringence (B) and fluorescence (C). Immunohistochemistry revealed the amyloid to be of the TTR type (D). He was referred to the NAC for investigation.

**Figure 4.3: Histopathological sections from case 2 demonstrating amyloid of the TTR type**

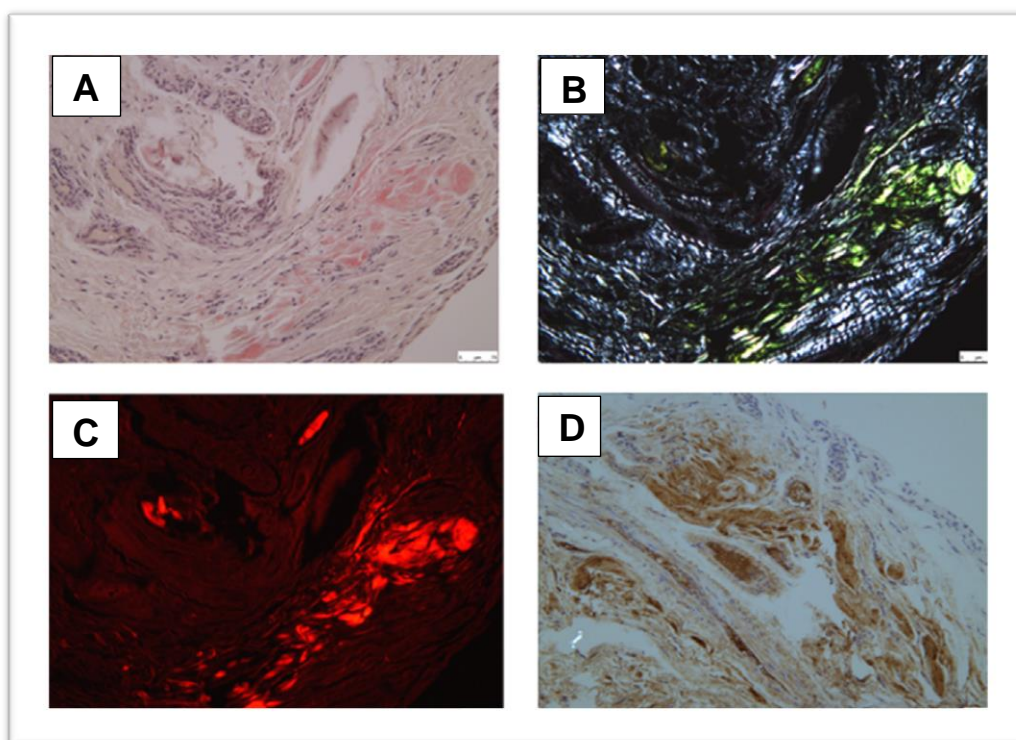

**Congo Red binding (A) Apple green birefringence (B) and fluorescence (C). Immunohistochemistry revealed the amyloid to be of the TTR type (D)**

Gene sequencing revealed wild-type TTR gene sequence. He described no classical heart failure symptoms, 6-minute walk test was normal, as were the ECG and echocardiogram. He declined cardiac MRI. Blood results showed normal range NT-Pro BNP and Troponin.  $^{99m}\text{Tc}$ -DPD showed no cardiac uptake. SPECT was suggestive of very early cardiac uptake in the intraventricular septum and LV wall (Figure 4.4). He will be followed-up for repeat assessment in 24 months.

**Figure 4.4:**  $^{99m}\text{Tc}$ -DPD and SPECT CT images of Case 2

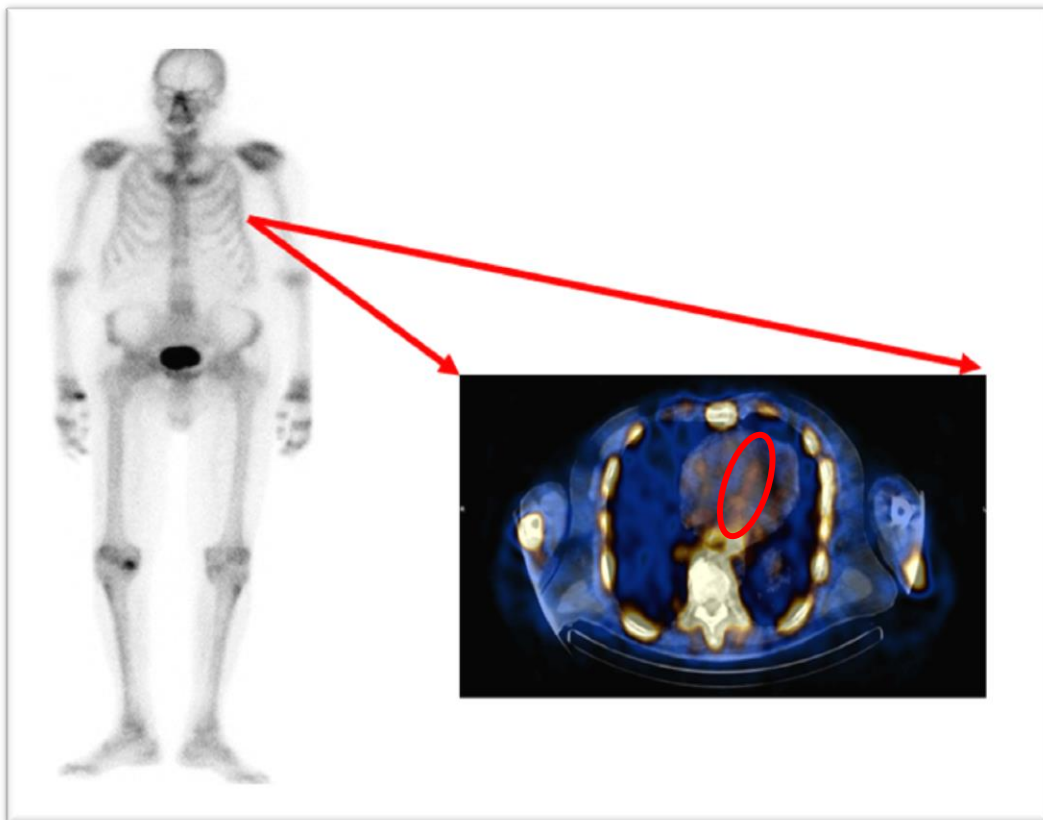

$^{99m}\text{Tc}$ -DPD does not show cardiac uptake but the SPECT CT image from the same scan is suggestive of early uptake in the intraventricular septum (red circle).

**Discussion:**

Carpal tunnel biopsy can readily identify amyloid deposition within the carpal tunnel, with TTR amyloid being the predominant amyloid type identified. Carpal tunnel biopsy in combination with <sup>99m</sup>Tc-DPD scintigraphy has the potential to identify clinically silent cardiac amyloidosis at a potentially more treatable stage.

16.7% of those with carpal tunnel syndrome undergoing decompression surgery had amyloid detectable within the symptomatic carpal tunnel. Of these, 11.7% had TTR amyloid deposits. These prevalence rates are similar to study findings from other countries; Germany any amyloid 19%, TTR amyloid 16.49% [210], Japan any amyloid 9.26%, TTR amyloid 1.85% [211], and in a more recent Japanese study from 2011; 34% amyloid prevalence was found all of which was TTR [172]. These studies pre-dated the introduction of <sup>99m</sup>Tc-DPD scintigraphy which can identify early cardiac amyloidosis even before cardiac MRI [164], is non-invasive, sensitive and specific and can be used to follow-up those in whom TTR amyloid deposits have been found at carpal tunnel decompression surgery.

These results suggest a low prevalence of cardiac involvement at the time of carpal tunnel release surgery. Only two individuals with aTTR in the carpal tunnel attended the NAC for assessment. Neither had definitive evidence of cardiac amyloidosis and both will be kept under long-term follow-up. The population in which amyloid was identified in our study was older ( $p=0.0092$ ). This is in keeping with data from TTR amyloid biopsies taken from those with lumbar spinal canal stenosis [174]. There were more females with TTR amyloid found in the carpal tunnel than males (71%).

Since the completion of this work a prospective study has been published (Sperry 2018). This study from the U.S found a similar prevalence of amyloid deposits (10.2%) in the 98 patients enrolled. 7.14% had definitive TTR amyloid, only one of which had cardiac involvement, a 64-year-old male with a wild-type TTR gene, no signs or symptoms of heart failure and a normal ECG and BNP. Echocardiogram, however, revealed increased septal wall thickness (1.3cm) and impaired global strain rate of -15.8% and <sup>99m</sup>Tc-DPD scintigraphy revealed grade 3 cardiac uptake. The carpal tunnel biopsy allowed the identification of clinically silent cardiac amyloidosis and treatment with diflunisal, an old-

fashioned non-steroidal anti-inflammatory drug that is known to be a TTR stabiliser, was initiated.

They were also able to identify the following factors from their data associated with an increased likelihood of finding TTR amyloid in the carpal tunnel from their cohort; older age, bilateral carpal tunnel syndrome, history of previous carpal tunnel decompression, history of spinal stenosis and spontaneous biceps tendon rupture.

As explored in the previous chapter, little is known about the early natural history of ATTRwt amyloidosis. Progression from soft tissue amyloidosis to the involvement of other organs over time is expected (Figure 4.5), but this does not appear to be inevitable, and when it does evolve, the time to organ dysfunction is unknown but likely to be many years. Sperry *et al* measured the TTR concentration in the blood of those with and without soft tissue ATTR deposition as a possible explanation for why amyloidosis with a physiological protein may occur in some individuals with carpal tunnel syndrome but not others[213]. They found no difference in TTR concentrations between the two groups[213]. In addition, they used a subunit exchange assay to quantify TTR tetramer kinetic stability but again found no significant difference. This suggests that there are other mechanisms involved in the aggregation of TTR as amyloid fibrils. As discussed both genetic and wild type variants of the TTR protein form amyloid[167]. In vitro studies of TTR fibrillogenesis have identified a novel mechano-enzymatic mechanism using trypsin and 900 rpm double-orbital shaking that generates abundant amyloid fibrils[11]. In vivo, however, trypsin is synthesized by the exocrine pancreas only and is secreted exclusively into the duodenum and it is difficult to understand its role in TTR fibrillogenesis in ATTRwt deposition in the carpal tunnel, for example. Using a bioinformatics search for more ubiquitous proteases, plasmin, has been identified as the putative proteolytic enzyme[214]. Plasmin was found to cleave human TTR under physiological conditions promoting fibrillinogenesis *in vitro* and this was, like trypsin, greatly enhanced by mechanical agitation.

It is interesting that agitation is necessary for TTR amyloid fibrillogenesis in vitro with both trypsin and plasmin because TTR amyloid is often found in tissues which are contractile, under pressure or shear stress. The raised pressure in



the symptomatic carpal tunnel has already been described and can be as high as 100 mmHg upon wrist flexion, similar to the pressure found in the left ventricle in systole[201]. ATTR is also reported in those with aortic stenosis where the pressure gradient across the valve can be greater than 60mmg Hg in a severely stenosed aortic valve with much agitation of the blood passing through the stenosed valve [215, 216]. Similarly, a high prevalence (45.3%) of ATTR has been found in the ligamentum flavum of those undergoing lumbar canal decompression surgery for spinal canal stenosis[174]. There are significant changes in pressure in the symptomatic stenotic spinal canal upon spinal movements particularly extension which can result in pressures of up to 37.97 mmHg significantly agitating contents of the canal [217]. Yanagisawa *et al*, like Sperry *et al*, found no significant difference in serum transthyretin concentrations in patients with ATTRwt deposits in the ligamentum flavum and those without[174]. They also used mass spectrometric analysis to identify mutant transthyretin protein in serum samples but found only wild type TTR proteins in those with and without ATTR deposits. These patients did not undergo <sup>99m</sup>Tc-DPD scintigraphy or other cardiac investigations, but the authors comment that there were no cardiac symptoms in those in whom ATTR was identified.

Another important finding from Yanagisawa and colleagues was that the amount of transthyretin amyloid in the ligamentum flavum was related to older age, to the thickness of the ligamentum flavum on MRI scanning, and to a higher degree of spinal segment instability[174]. This suggests that older individuals presenting with lumbar canal stenosis with a high degree of spinal instability and thickened ligamentum flavum, should have histology sent looking for amyloid deposits and could undergo <sup>99m</sup>Tc-DPD scintigraphy to identify silent cardiac amyloidosis. The bladder is another site at which TTR amyloid deposits can be found (Chapter 3). The contraction of the large detrusor muscle generates intravesical pressure changes of up to 20mmHg when voiding under physiological conditions[218]. Of note, these pressure gradients rise significantly with bladder outflow obstruction caused by prostate hypertrophy; a condition afflicting older males much like the population diagnosed with cardiac ATTRwt amyloidosis[219].

Perhaps further evidence of the mechano-enzymatic mechanism of TTR amyloidogenesis in vivo comes from our clinical observation that many patients at the NAC with a diagnosis of cardiac wtTTR amyloidosis were previously unusually athletic (significant sporting achievements) or performed physically demanding jobs (farming). In keeping with this, ATTR has also been widely reported in tendon tears in the upper limbs, most prevalent in older age groups and with significant impingement symptoms [220, 221]. TTR amyloid deposits are also readily identified in degenerative joints at joint replacement surgery particularly of the knee [222]. However, recent work suggests that ATTR deposition is not just a biomarker of severity of OA (a demonstration that the increased mechano-forces in the more severely degenerative joints promotes TTR amyloidogenesis but murine studies directly link ATTRwt deposition to the pathogenesis of osteoarthritis, with intra-articular injection of aggregated TTR in WT mice leading to increased synovitis and significantly enhanced expression of inflammatory genes in the synovium both in surgically induced (destabilising of the medial meniscus) and in aging murine models of osteoarthritis[223]. Given the very high global prevalence of osteoarthritis this suggests further study is required, particularly given the new therapies licensed for ATTR amyloidosis. This also suggests there may be a role for the old fashioned nonsteroidal anti-inflammatory drug, diflunisal, which is a TTR stabilizer, in individuals with osteoarthritis.

This study demonstrates that carpal tunnel biopsy can identify those who may be at risk of developing wATTR amyloidosis and its more widespread use will help to elucidate the natural history of the disease. There appears to be a low level of cardiac amyloidosis at the time of carpal tunnel decompression surgery but the majority of those diagnosed with cardiac ATTR amyloidosis have a history of carpal tunnel syndrome or decompression surgery. This suggests that carpal tunnel syndrome may occur early in the disease, many years before cardiac involvement and can be used to identify at-risk populations, particularly when used in combination with the highly sensitive and specific <sup>99m</sup>Tc-DPD scintigraphy. A proposed natural history of ATTRwt is depicted in Figure 4.5.

This is a retrospective case control study and has a number of limitations. The numbers of positive samples containing TTR are small and results are further

diminished by the difficulties encountered in inviting those with positive samples to attend the NAC for assessment.

Additionally, as the cases were identified from histology requests only and as this was not a prospective study, we did not have clinical details about the individuals over and above that documented on the biopsy label i.e. basic demographic data and date of biopsy. Full clinical details such as bilateral carpal tunnel symptoms, presence of spinal stenosis, history of tendon rupture, occupational or sporting history and neurophysiology results would aid conclusions that can be drawn from the data, particularly with respect to identifying an at-risk population to biopsy on clinical grounds in the future. Ultimately a prospective study is required with long-term follow-up.

This study has informed the design of a multi-centre prospective study to identify the UK prevalence of ATTR amyloid in those with carpal tunnel syndrome; IRAS 181075: Prevalence of ATTR amyloid in the carpal tunnel (Figure 4.6). Long term follow-up of the cohort identified by this study will help to inform the natural history of ATTRwt amyloidosis and permit earlier administration of potential disease modifying therapeutic agents, especially in light of new data which suggests that the recently licenced agents, which appear to be of greatest benefit in patients with early-stage cardiac disease[224].

Figure 4.5: Proposed natural history of ATTRwt amyloidosis

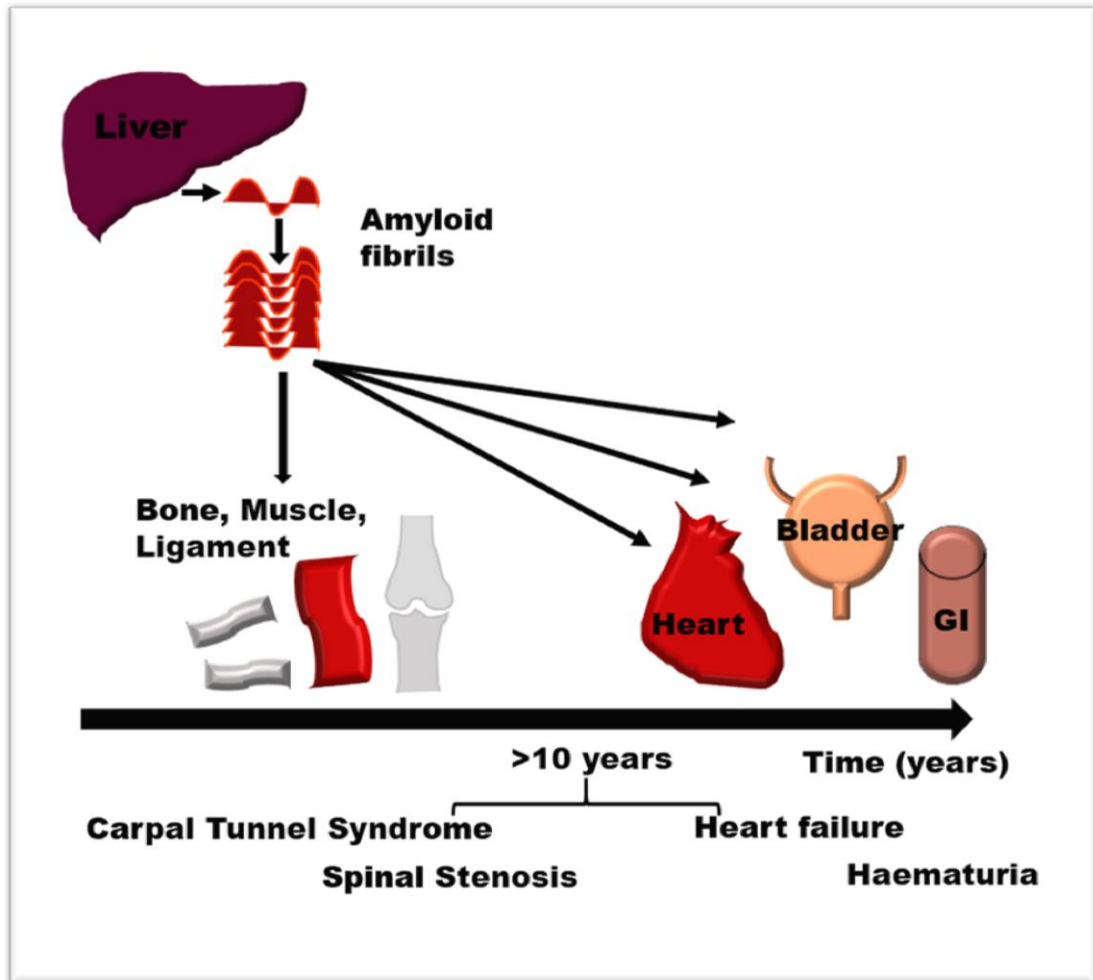

Data from Chapters 3 and 4 suggest that carpal tunnel and other musculoskeletal TTR amyloid deposition may develop many years before the accumulation of ATTR in the heart and viscera, as depicted above. This is an important observation in light of the newly licenced TTR stabilising drugs, which if given early may prevent cardiac and visceral amyloidosis, although the progression to systemic amyloidosis does not appear to be inevitable and further studies are required.

Figure 4.6: Flow-chart for prospective study of the prevalence of TTR deposits in the carpal tunnel and long-term study to investigate the natural history of ATTRwt

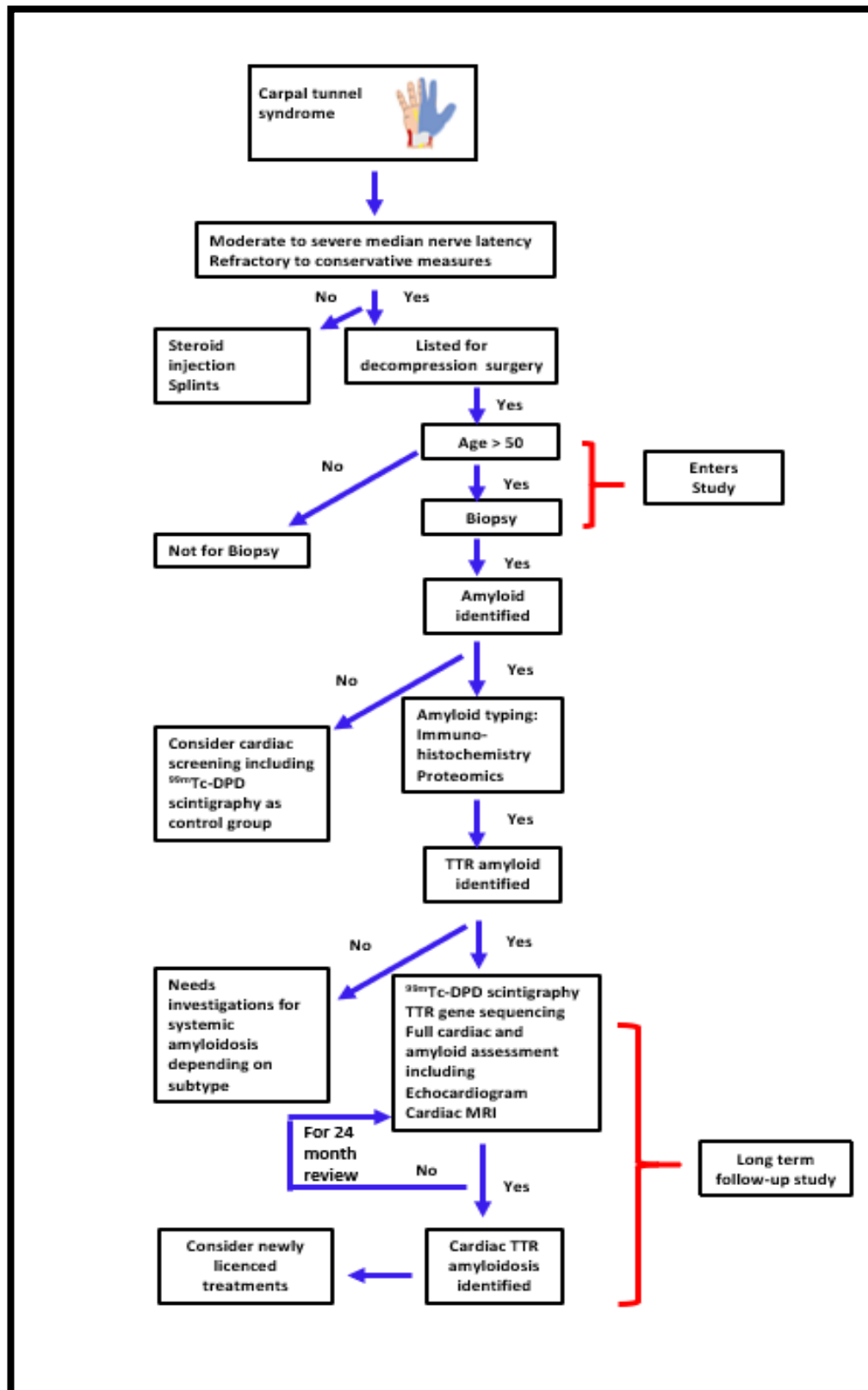

## Chapter Five:

### The changing aetiology of AA Amyloidosis

#### Introduction

Systemic AA amyloidosis is a rare but serious complication of chronic inflammation. As described in Chapter One, the precursor protein is serum amyloid A protein (SAA), an apolipoprotein of the HDL class with postulated functions in innate immunity and lipid homeostasis[89]. It is synthesized mostly by hepatocytes in response to pro-inflammatory cytokines particularly tumour necrosis factor (TNF) alpha, interleukin-1 (IL-1) and interleukin-6 (IL-6). SAA is a soluble apolipoprotein, with 4 related genes, the amyloid precursor is thought to largely derived from the SAA<sub>1</sub> gene[90]. It has a number of polymorphisms and SAA<sub>1.1</sub> homozygosity in particular is associated with a higher risk of developing AA amyloidosis in both humans and in murine models[225].

The pathophysiology of AA amyloidosis is not yet fully understood but it is thought that circulating SAA is bound to high-density lipoproteins in the plasma which protect SAA from proteolysis by matrix metalloproteinases and prevent misfolding[14]. Unbound soluble SAA appears to be intrinsically unstable and readily taken up by macrophages, then degraded in the lysosome compartment forming stable soluble oligomers [89]. These prefibrillar oligomers accumulate in the extracellular space along with SAP, lipid moieties and glycosaminoglycans to form mature amyloid fibrils[226].

The median physiological plasma concentration of SAA is 3 mg/L and this can rise to levels as high as 2,000 mg/L in response to pro-inflammatory stimuli[227]. Sustained production of SAA is a risk factor for the development of AA amyloidosis and as such any proinflammatory insult which causes abnormal elevations of SAA, either from chronic inflammation or following recurrent episodes of inflammation over many years. The condition is highly likely to be underdiagnosed and large cohort data have shown a highly variable prevalence

between countries, probably reflecting different disease burdens locally leading to chronic inflammation[228].

Typically, AA amyloidosis manifests as proteinuric renal failure and is, therefore, most commonly diagnosed on renal biopsy[25]. It is unclear why there is tropism of SAA fibrils for the kidneys but at presentation there may be other visceral amyloid identifiable on SAP scintigraphy, with almost universal splenic deposits and liver deposition demonstrable in 23% at diagnosis[25].

Identifying the origin of the inflammation is important for targeting treatment to suppress the acute phase response. The suppression of the serum SAA concentration to <10mg/L has the dual benefit of preventing further accumulation of visceral amyloid deposition, while allowing existing amyloid deposits to slowly regress, although this does not occur in all individuals[25]. This process of stabilisation and regression can be readily demonstrated using serial SAP scintigraphy. Regression of amyloid deposits has been shown to improve organ function and the degree of SAA elevation linked to poor overall prognosis [12, 25]. Further adverse prognostic factors that have been identified include: (i) older age at diagnosis, (ii) underlying sepsis, (iii) Crohn's disease, and (iv) end-stage renal disease at presentation[25]. Positive prognostic factors are related to sustained reduction in SAA synthesis; thus, those with periodic fever syndromes, for which there is highly effective treatment, have a better prognosis[25, 229]. Therefore, detailed assessment of patients to identify the underlying cause of inflammation is the gold standard approach.

### **The UK NAC systemic AA amyloidosis cohort**

The UK National Amyloidosis Centre has the largest known cohort of individuals with AA amyloidosis. It has been well described in the literature [25, 91]. This cohort was also analysed in the context of an epidemiological study of systemic amyloidosis in England which determined that 48% of the UK caseload of patients with amyloidosis were referred to the NAC[20].

Data from the cohort is maintained on a database which, for the purposes of this study, was updated from the last published data with a censor date of

February 2017. There have been 659 cases of AA amyloidosis seen at the NAC since 1990. Over 27 years the rate of new cases has remained remarkably constant with a median of 24 diagnoses per annum (IQR 18.5-30.5), however, AA amyloidosis represents a decreasing proportion of new cases of systemic amyloidosis (35-5%) due to the large increase in diagnoses of AL and other forms of amyloidosis over this period of time[91]. Over time the median age of presentation with AA amyloidosis has increased as has the percentage of those presenting in end-stage renal failure (15-29%)[91].

The aetiology of the inflammation causing AA amyloidosis has also changed significantly over the cohort's 27 years. Between 1990-1997 the most prevalent cause of AA amyloidosis was inflammatory arthritis. In contrast, between 2007-2014 most commonly the aetiology of the inflammation could not be identified (termed idiopathic AA amyloidosis for the purposes of this study). These patients have been extensively investigated including genetic sequencing for heritable periodic fever syndromes and <sup>18</sup>F-FDG-PET CT imaging [92].

The patients in the NAC cohort undergo serial SAP scintigraphy and SAA measurements to ensure the inflammatory response is adequately suppressed. Lachmann and colleagues reported the results of serial SAP scintigraphy scans on 221 patients with AA amyloidosis. In 12% the amyloid burden increased, in 48% it was unchanged, and in 39% there was evidence of regression from baseline. [25]. Figure 18 depicts amyloid regression in a patient with juvenile idiopathic arthritis treated successfully with anti-TNF therapy.



**Figure 5.1: SAP scintigraphy showing regression of amyloid following suppression of serum SAA levels**

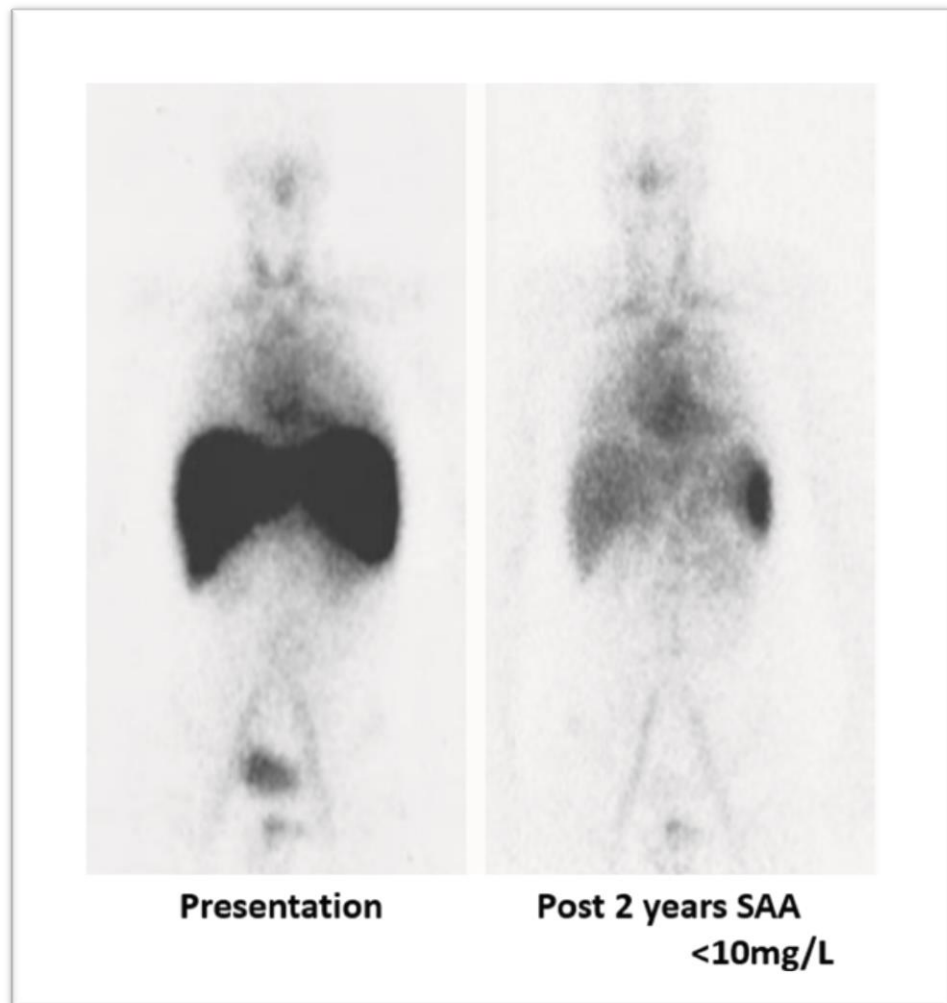

The patient with juvenile idiopathic arthritis presented with proteinuric renal failure. Renal biopsy revealed aa amyloidosis. SAP scintigraphy (anterior views only) demonstrated a heavy amyloid load in the liver, spleen and both kidneys. Treatment with anti-TNF therapy was initiated. Serum SAA level were suppressed to below 10mg/L and serial SAP scintigraphy showed regression of the visceral amyloid load.

Lachmann and colleagues clearly established that increased production of SAA was the most powerful risk factor for end-stage renal failure and death[25]. Thus, treatment must be aimed, not just at clinical remission but also at suppression of SAA production. This can represent a therapeutic challenge. Corticosteroids are an unattractive empirical option due to the need for long

term, possibly life-long, treatment and their well-documented significant side effects. Colchicine can be used with good effect, but dosing is often limited by gastrointestinal side-effects. More recently targeted cytokine treatments have been trialled empirically in the NAC cohort [92, 93]. IL-1 inhibitors were given to 11 patients with idiopathic AA amyloidosis[92]. Of these nine responded and a quarter of these showed regression on serial SAP scintigraphy with stabilisation of deposits in the rest of the responders. IL-6 inhibition is perhaps an even more attractive therapeutic option in AA amyloidosis as it acts to suppress the main driver for the production of SAA. The empirical use of the IL-6 inhibitor tocilizumab led to suppression of SAA production to <10 mg/L in all 14 cases within ten days of the first dose [93]. Novel therapies aimed at promoting clearance of existing amyloid deposits, such as the anti-SAP antibody in combination with CPHPC (see Chapter One) may be an effective treatment approach in the future, following suppression of SAA production.

Interestingly, whilst it is well recognised that chronic elevations of SAA in the blood is linked to the development of systemic AA amyloidosis, it is not an inevitable consequence of inflammation, occurring in only 5-10% in chronic inflammatory diseases [230, 231]. This suggests unidentified susceptibility factors that may be involved in the pathogenesis of the disease. Based on clinical observation that many patients attending the NAC with AA amyloidosis were overweight, this study sought to explore the possibility of obesity as a susceptibility factor in patients with idiopathic AA amyloidosis.

## Methods

Cases of AA amyloidosis where no cause could be found (Idiopathic AA Amyloidosis) were identified from the established database of the NAC AA amyloidosis cohort already described. The database was updated from the previously published data to February 2017[91].

The control group was identified from the NAC AA amyloidosis database as those with a definitive underlying cause for their AA amyloidosis; (i) monogenic systemic autoinflammatory disease, (ii) rheumatoid arthritis and (iii) ankylosing spondylitis.

Body mass index (BMI) was used as an indirect marker of body fat and calculated using the formula:  $\text{weight (kg)}/[\text{height (m)}]^2$  with reference ranges for BMI as follows: < 18.5 underweight, 18.5-24.9 normal, 25.0-29.9 overweight, >30 obese[232].

Serum amyloid A (SAA) and C-reactive protein (CRP) were quantified using standard techniques as outlined in Chapter Two. Normal range limits were <5 mg/l for CRP and <6.4 mg/l for SAA.

Data was analysed using an unpaired *t* test and Kaplan–Meier survival analysis using GraphPad Prism<sup>®</sup> 6.0 (La Jolla, CA)

## Results:

### Whole cohort characteristics:

Six hundred and fifty-nine patients with AA amyloidosis were seen between 1990 and 2017. Three hundred and fifty-four (53.7%) were male. The median age at first presentation was 56 years (range 90 – 91 years). The underlying diagnoses of the whole cohort are detailed in Figure 5.2.

**Figure 5.2: Underlying aetiology of inflammation in 659 cases of systemic AA amyloidosis seen at the NAC over 27 years**

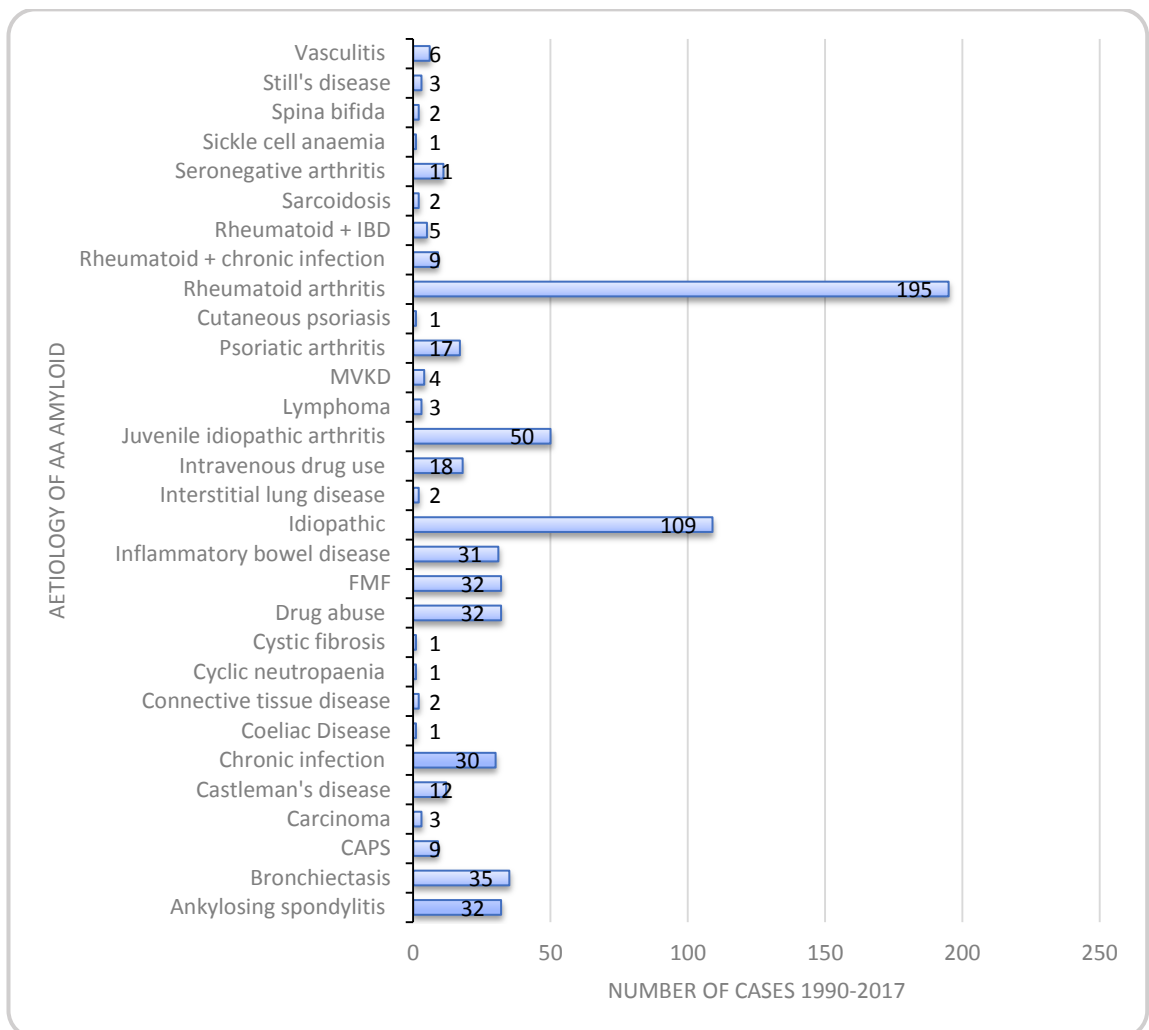

Rheumatoid arthritis is the predominant cause of AA amyloidosis in the NAC cohort. Idiopathic, or unknown aetiology, is the next most common. Juvenile arthritis is third.

When the underlying aetiology of the systemic inflammation were analysed over time, changes in the underlying aetiology became apparent (Figure 5.3). Of note, there has been a significant decrease in new cases of AA amyloidosis where the underlying cause is JIA ( $p < 0.0001$ ), an increase in inflammation caused by injected drug use and a significant increase in apparent idiopathic cases of AA amyloidosis.

**Figure 5.3: Changing aetiology of NAC AA amyloidosis cohort over 27**

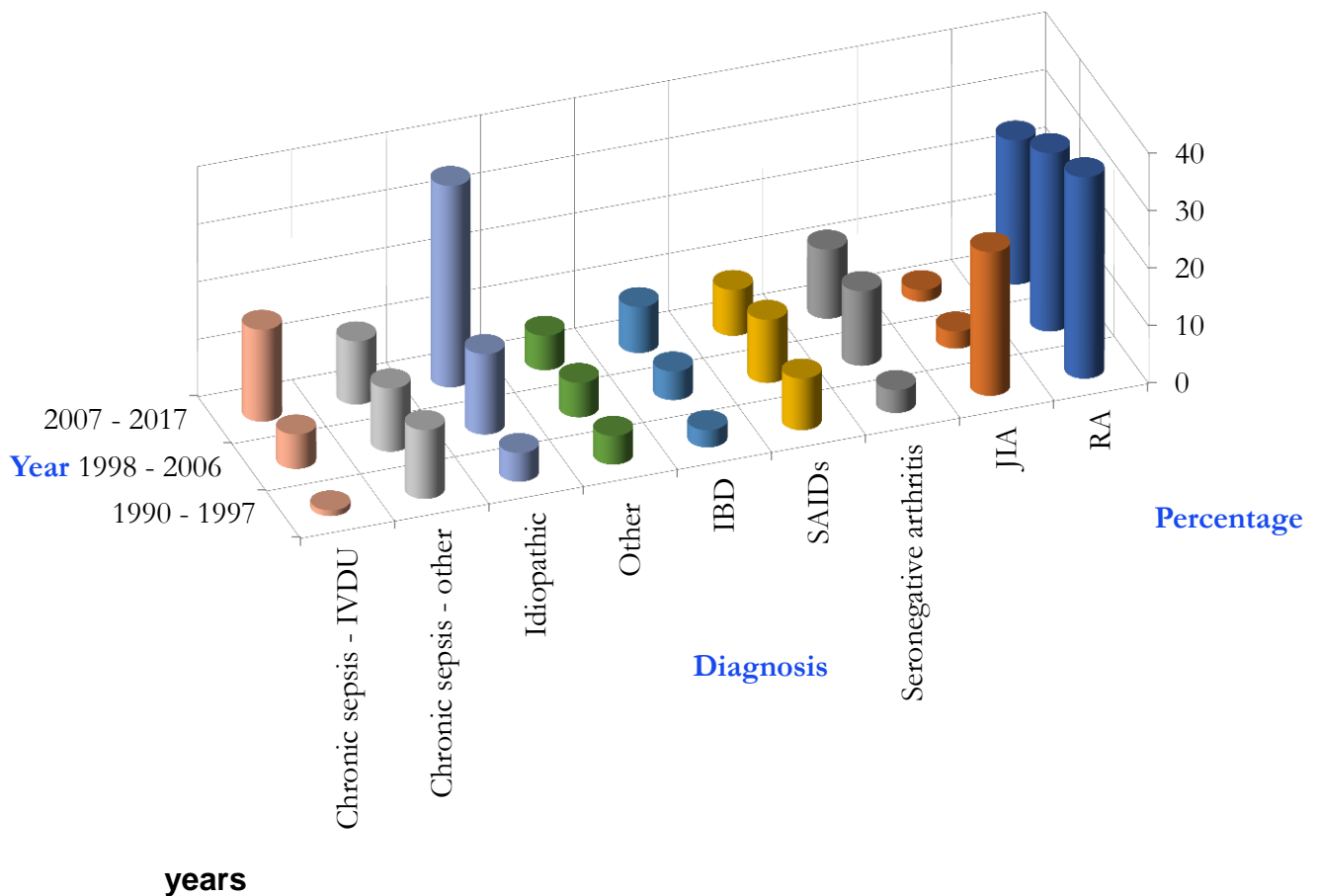

Updated analysis of the underlying aetiology of the NAC AA amyloidosis cohort. The original figure was published by Lane and colleagues with censor date of 2014 [91]. This figure demonstrates the changing aetiology of the NAC AA amyloidosis cohort from 1990-2017.

### Study cohort characteristics

97 individuals with idiopathic AA amyloidosis were identified. 50% were male. Height and weight data was available for 73 individuals (76%) and the remaining 24 were, therefore, ineligible for the study as BMI at presentation could not be calculated. A control cohort of 104 cases of AA amyloidosis, 33% male, with a diagnoses of inflammatory arthritides and systemic autoinflammatory disease was used for comparison. Figure 5.4 depicts the underlying diagnoses in the control group. All cases with these diagnoses in the NAC AA amyloidosis database and with height and weight data recorded at baseline were used in the control group. Median age in the idopathic cohort was 59.6 years and 57.3 years in control group (p=0.41).

**Figure 5.4: Control AA amyloidosis cohort**

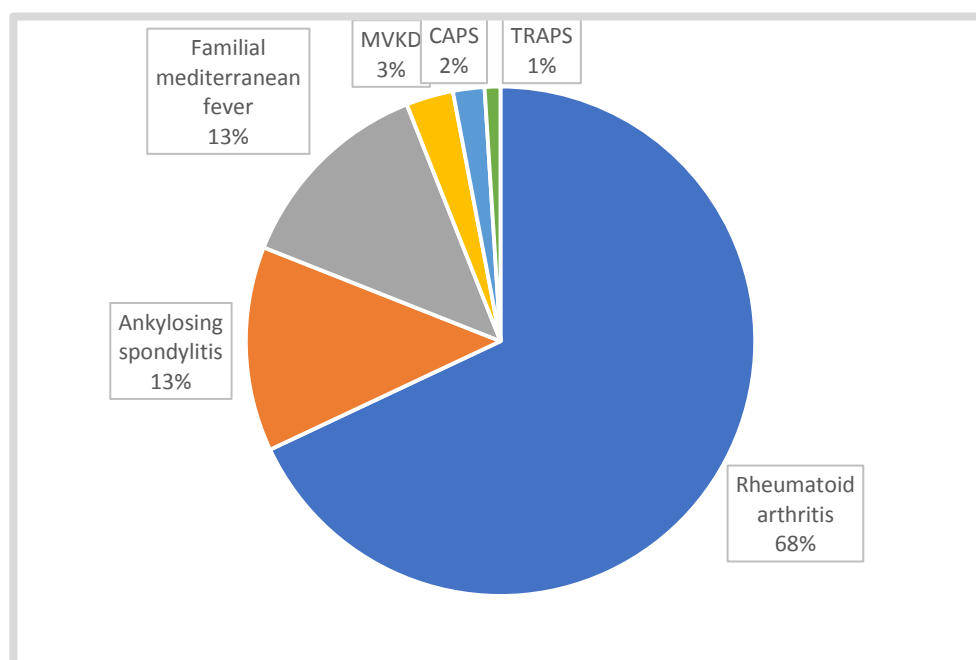

The control cohort n=104 cases with AA amyloidosis with definitive underlying diagnoses of rheumatoid arthritis, ankylosing spondylitis, familial mediterranean fever (FMF), Mavelonate kinase deficiency (MVKD), Cryopyrin associated periodic syndrome (CAPS), TNF-receptor periodic syndrome (TRAPS).

The median BMI for the idiopathic cohort was significantly higher at 27.2 vs 24.11 in the control cohort ( $p < 0.0001$ ). Further analysis showed that of the idiopathic cohort; 60% were overweight and 39% obese. In the control group 43% were overweight, 27% obese (Table 5.1).

**Table 5.1: Idiopathic and control cohort baseline characteristics and BMI**

<b>Median Baseline Characteristics (First visit to NAC)</b>	<b>Idiopathic Cohort n=73</b>	<b>Control Cohort n=104</b>	<b>Significant difference between groups</b>
<b>Age (years)</b>	<b>59.6</b>	<b>57.6</b>	<b>No</b>
<b>Female</b>	<b>50%</b>	<b>67%</b>	<b>No</b>
<b>Proteinuria (g/L)</b>	<b>4</b>	<b>3.65</b>	<b>No</b>
<b>Serum Creatinine (<math>\mu\text{mol/L}</math>)</b>	<b>158</b>	<b>157</b>	<b>No</b>
<b>CRP (mg/L)</b>	<b>22</b>	<b>27.5</b>	<b>No</b>
<b>SAA (mg/L)</b>	<b>33</b>	<b>46</b>	<b>No</b>
<b>% Overweight</b>	<b>60</b>	<b>43</b>	<b>-</b>
<b>% Obese</b>	<b>39</b>	<b>27</b>	<b>-</b>
<b>Median BMI</b>	<b>27.2</b>	<b>24.1</b>	<b>Yes</b>

			P<0.0001
--	--	--	----------

Figure 5.5: Body mass index between idiopathic and control groups

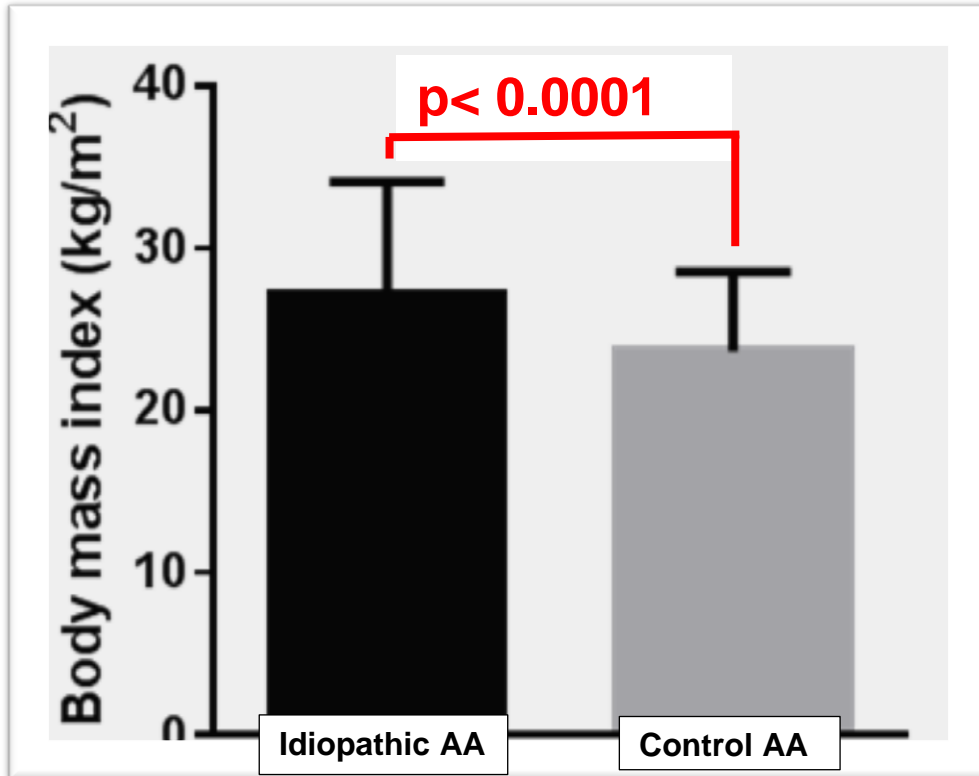

Figure shows statistically significant difference in BMI between the two cohorts. Although the Idiopathic AA group have significantly raised BMI's their median BMI is not in the obesity range.



## Survival

Median survival in the control group was 92.49 months. In the idiopathic group it was 66.16 months. This difference was of borderline statistical significance using the Log-rank (Mantel-Cox) test ( $P=0.05$ ) (Figure 5.6).

**Figure 5.6: Kaplan-Meier survival curve of the idiopathic and control cohort with AA Amyloidosis**

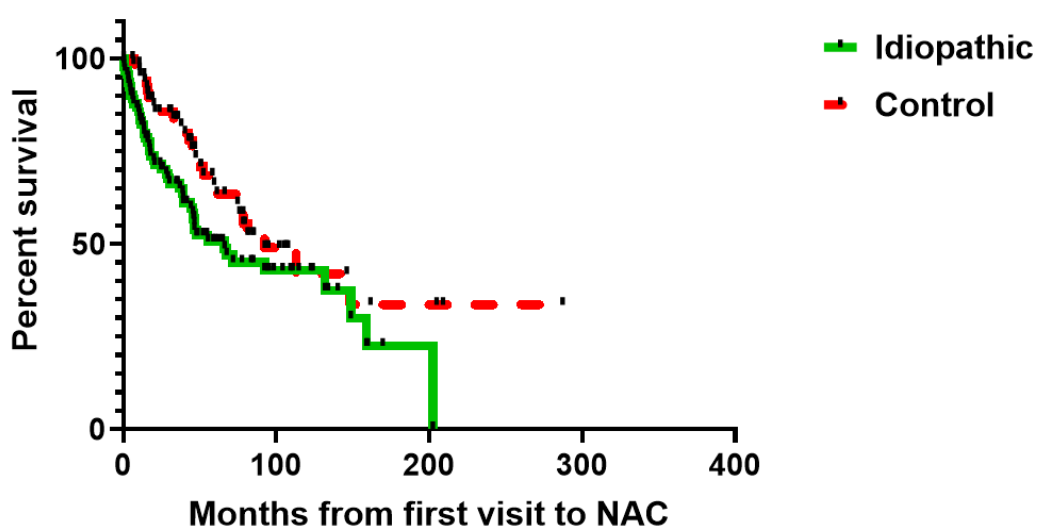

Kaplan-Meier curve showing the survival from first visit of the two groups with AA amyloidosis.

### Comparisons with other cohorts

Since presentation of this data two other groups have replicated these findings (Table 5.2). They have found very similar results with low grade persistent inflammation, mild renal impairment and low-grade proteinuria. However, they both had a female predominance and BMI's in the higher obese range.

**Table 5.2: Median baseline demographics of the three reported cohorts where BMI in those with AA amyloidosis have been investigated**

	<b>Youngstein <i>et al.</i> n=73</b>	<b>Stankovic <i>et al</i>[233]. n=13</b>	<b>Blank <i>et al</i>[234]. n=37</b>
<b>Age (years)</b>	59.6	56	65
<b>Gender (%female)</b>	50	92	73
<b>Serum Creatinine (µmol/L)</b>	158	176	Not reported
<b>Proteinuria (g/L)</b>	4	1	2
<b>BMI (Kg/m<sup>2</sup>)</b>	27.2***	35***	31***
<b>CRP (mg/L)</b>	22	21	15
<b>SAA (mg/L)</b>	33	19	28

Data showing the similarities of the three reported cohorts in which obesity has been identified as a susceptibility factor for AA amyloidosis. \*\*\* denotes p<0.001 when comparing to individual study control group.

## Discussion

We found that the BMI is significantly higher in patients with AA amyloidosis of idiopathic origin when compared to the well phenotyped control group who otherwise exhibited similar baseline demographics ( $p < 0.0001$ ). This suggests that adipocyte synthesis of pro-inflammatory cytokines may produce a chronic low-grade acute phase response in some people causing AA amyloidosis over time. Inflammatory markers (CRP and SAA) were both mildly elevated and renal impairment was not severe. Although the median BMI was significantly higher than in the control group, it did not fall within the morbidly obese range.

Currently the UK population mean BMI is 27.4 in men and 26.9 in women, with 41% of men and 33% of women classified as overweight, and 26% and 24% as obese. Given the data shown, this observation raises the possibility that AA amyloidosis may become more common, a cause for concern over and above the public health problems already posed by rising obesity rates [235]. Indeed, due to the increased complications associated with renal biopsy in those who are obese, it is possible that AA amyloidosis in this cohort is significantly under diagnosed.

Since the initial presentation of this data[236], these findings have been replicated by other groups in both Germany and France, [234], [233](Table 5.2). The French group described 13 cases of AA amyloidosis who, despite extensive imaging and serological studies, had no cause for their chronic inflammation found[233]. All of these patients were obese, with a median BMI of  $35\text{Kg/m}^2$  and they concluded no other cause, but obesity, could explain the chronic inflammation leading to AA amyloidosis. As in our cohort, these patients had low grade proteinuria (median  $1\text{g}/24$  hours) and a modest rise in acute phase markers (median CRP  $21\text{mg/L}$ , median SAA  $19\text{mg/L}$ ), but unlike our cohort 92% were female. The authors also noted a possible important finding that warrants further research; that review of the renal biopsy in these cases demonstrated a higher proportion of vascular amyloid rather than the predominant glomerular deposition usually seen.

The German group describe 37 cases of idiopathic AA amyloidosis with a median age of 65 years and median BMI of  $31\text{Kg/m}^2$ , significantly higher

( $p < 0.001$ ) than two control groups; (i) FMF or rheumatoid disease with AA amyloidosis and (ii) those with chronic inflammation but no AA amyloidosis[234]. They also report very similar low-grade inflammation (median CRP 15mg/L, SAA 28mg/L) and found that, in addition to obesity, age at AA amyloidosis diagnosis ( $p = .00002$ ) and female gender ( $p = .004$ ) were significantly more common in their idiopathic group.

Blank and colleagues also performed SAA<sub>1</sub> genotyping and found the SAA<sub>1.1</sub> homozygous genotype was more prevalent ( $p < .0001$ ) when compared to non-inflammatory controls. They also measured the serum levels of the adipokine leptin and found this correlated with BMI in all cases.

It has long been known that excess adipose tissue is associated with a raised acute phase response and that cytokines and chemokines released from adipose tissue contribute to obesity-related complications such as cardiovascular and metabolic disease[237]. Macrophage infiltration is also increased in the adipose tissue of obese rodents and is an important source of inflammation [238]. Marked visceral amyloid deposition was initially described in obese-hyperglycemic mice with the genotype *ob/ob* in 1977[239]. Obesity-induced chronic inflammation has also been reported in high fat diet challenged mice who went on to develop accelerated renal amyloidosis as they aged[240].

Poitou and colleagues described a case of systemic AA amyloidosis concurrent with SAA overexpression in the subcutaneous white adipose tissue of an obese patient with a leptin receptor deficiency[241]. Based on their index case they investigated the role of SAA in common obesity and found much higher SAA expression in mature adipocytes than cells of the undifferentiated stroma vascular fraction ( $p < 0.01$ ). Moreover, SAA mRNA expression and circulating SAA levels were significantly higher in obese compared to lean subjects ( $p < 0.001$  and  $p < 0.01$  respectively)[242]. Strict calorie restriction resulted in a 45–75% reduction in levels of SAA transcripts and in circulating levels of the protein.

Similarly, SAA was measured in the serum of 18 patients with obesity before and after gastric bypass surgery[243]. Weight loss significantly decreased

SAA concentrations as well as mRNA expression of SAA in omental adipose tissue ( $p < 0.0001$ ).

### Case vignette

A 32-year-old female presented to her GP with lethargy and arthralgia. Inflammatory markers were found to be elevated. After multiple negative investigations she was referred to the fever clinic at the NAC. Her SAA was elevated and she was treated with empirical colchicine and then IL-1 inhibition with anakinra with only partial response over a decade. She had always been overweight, with a BMI at presentation of 43.2 Kg/m<sup>2</sup>. Bariatric surgery with gastric biopsy was undertaken. This resulted in reduction of BMI and circulating SAA levels (Figure 5.6).

**Figure 5.6: SAA and BMI response to immunosuppression and bariatric surgery in a 32-year-old female with idiopathic inflammation**

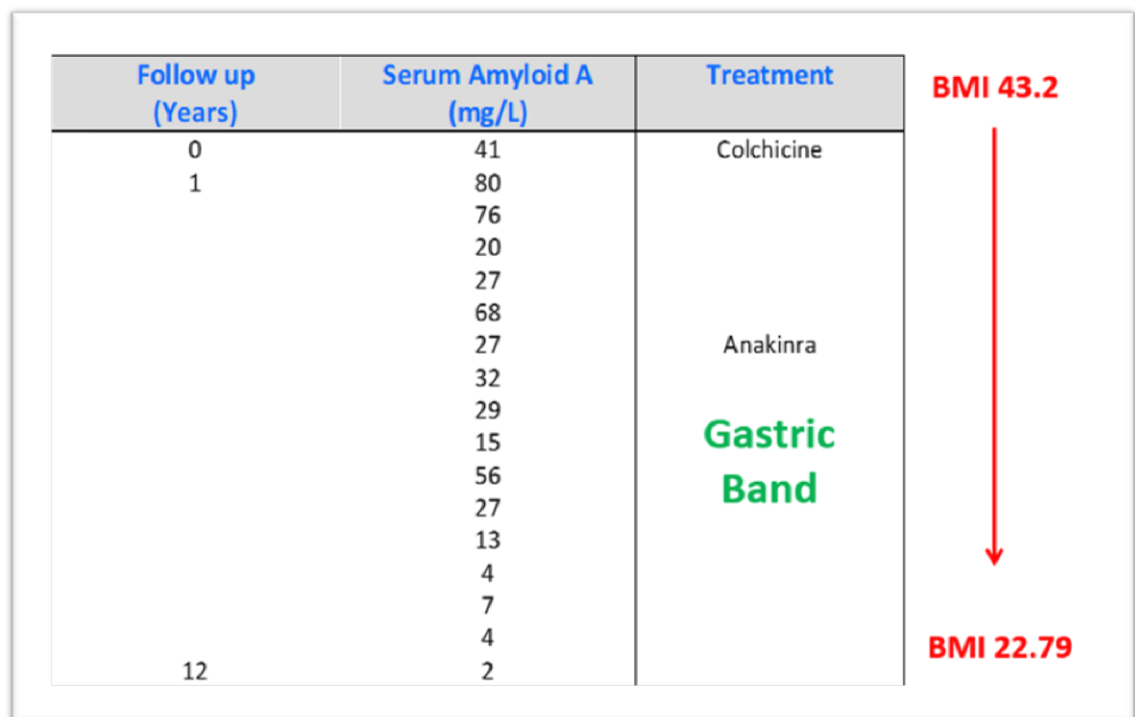

Figure showing response to immunosuppressants and then bariatric surgery in a female patient with significant acute phase response.

In summary, obesity was identified as a susceptibility factor in cases of idiopathic AA amyloidosis. BMI is a validated estimate of body fat composition

and is, therefore, an inexpensive tool that can be used in everyday clinical practice to identify these cases[244].

Importantly, this phenomenon appears to be occurring in individuals who do not need to be significantly morbidly obese, with our data suggesting that chronic low-grade elevations of circulating SAA over many years is important in the pathogenesis. These findings have now been replicated in two other groups, although the median BMI in both populations was higher and in the obese range.

We postulate that BMI in the over-weight and obese range is likely to be an important and emergent cause of renal impairment with major public health implications given the scale of the predicted obesity epidemic (dialysis costs £30,800 annually in the UK [245]). As such, active management of inflammation in overweight and obese patients is important. In obese patients with proteinuria renal biopsy is often considered high-risk due to body habitus. The potential renal complications of severe obesity include diabetes, hypertension and nephron loss, obesity related glomerulopathy and we now suggest AA amyloidosis. Consequently, SAP scintigraphy and or abdominal fat biopsy should be considered to look for AA amyloid deposition.

Empirical attempts to reduce circulating serum SAA levels should be made. This can be done by intensive weight-loss programme in the first instance. In cases where AA amyloidosis is established it may be necessary to use IL-6 inhibition until BMI and SAA normalise, as we know that even very low-level SAA levels (within what would be reported as normal range) have been shown to be closely linked to poor outcome[25]. Suppression of circulating SAA may lead to stabilisation and eventually improvement in renal function, delaying or negating the need for renal replacement therapy. Figure 5.7 summarises a proposed management algorithm. Future research directed to working with general practitioners and bariatric services may identify a larger cohort, to explore further the prevalence and role of the SAA<sub>1,1</sub> homozygous phenotype. This will allow identification of cases with AA amyloidosis at an early stage where renal function may be preserved using a calorie restriction and cytokine inhibition approach.

Figure 5.7: Proposed algorithm for the management of those with raised BMI an acute phase response and suspected AA amyloidosis

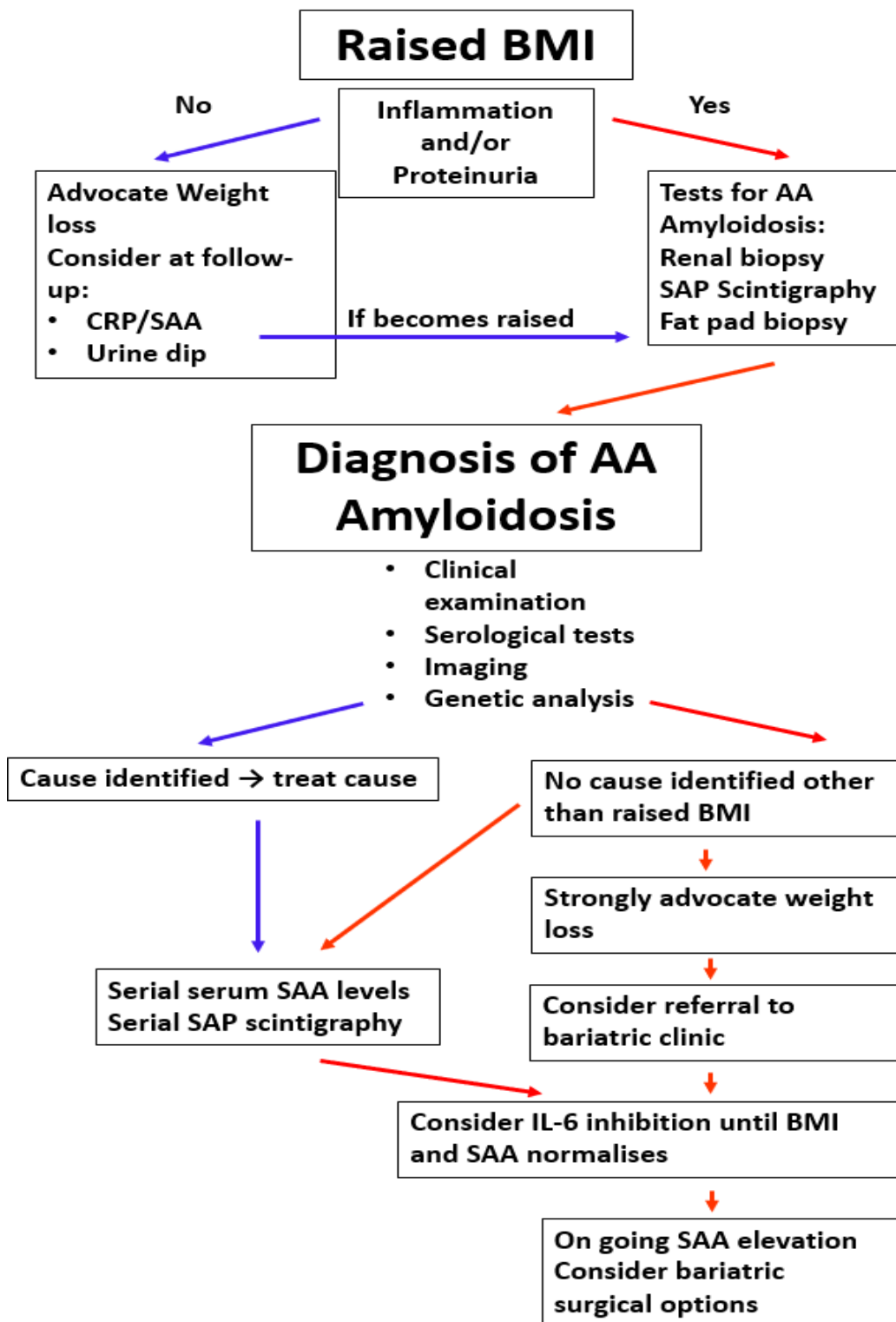

Figure showing proposed algorithm for the investigation of those with raised BMI and acute phase response, including the consideration of cytokine

## **Chapter Six:**

### **Interleukin-1 inhibitors in Pregnancy**

**“I am 20 weeks pregnant with my first child and I have chosen to continue to take anakinra during my pregnancy.**

**I have lived with CAPS symptoms for the initial 27 years of my life. Now that I have had a ‘holiday’ from CAPS I could never go back. Not even for one day.**

**No one wants to put an untested drug into their body when they are pregnant. Most other pregnant women are worrying about avoiding prawns and ibuprofen, however, it made perfect sense to me that my body would not be a welcome or suitable environment for an unborn child if I was experiencing symptoms”**

Email correspondence sent to me and shared with consent from a patient with CAPS when pregnant with her first child.



## **Introduction**

The first interleukin-1 inhibitor was licensed for use in rheumatoid arthritis in 2001, however, these agents have been most dramatically effective in the systemic autoinflammatory diseases (SAIDS)[246]. These diseases generally present during childhood, and with better disease recognition and diagnostics, their apparent incidence is rising and diagnostic delay is decreasing [247]. Treatment with interleukin-1 (IL-1) antagonists completely controls symptoms in a number of SAIDS, with dramatic and sustained improvement in quality of life [229]. For those with genetically determined SAIDs, these life-transforming therapies are likely to be required lifelong and many are unable to stop the medication prior to conception or during pregnancy.

More than a decade after the first reported use of IL-1 inhibition in SAIDs an increasing number of patients are reaching reproductive age and contemplating starting a family [101]. For those with well controlled disease and an expectation of a near normal duration and quality of life, information concerning their fertility and the potential risks to themselves and their children is of enormous importance. However, even compared to other biologic medications, few data on the safety of IL-1 antagonist are available in relation to conception, pregnancy or breast feeding. This paucity of sound evidence is recognized in a recent international consensus document on use of antirheumatic drugs around pregnancy whilst this may reflect the rarity of SAIDs, the lack of data is compounded by exclusion of reproductively active subjects from drug trials, and by manufacturers discouraging the use of biologic agents in women contemplating pregnancy [248]. As men must also use contraception when

participating in drug trials, there is a total lack of published data on the health of offspring born to fathers receiving IL-1 antagonists.

Currently there are three IL-1 antagonists, anakinra (Kineret®, Sobi), canakinumab (Ilaris®, Novartis) and rilonacept (ARCALYST®, Regeneron Pharmaceuticals) and their characteristics are summarized in Table 6.1. Anakinra is a small molecule that differs from the physiological IL-1 receptor antagonist by a single methionine base pair. Canakinumab is a monoclonal antibody with characteristic Fc domain and rilonacept is a dimeric, glycosylated fusion protein composed of the extracellular domains of the interleukin 1 receptor and an accessory protein IL-1-RAcP fused to the Fc domain of human IgG1. The presence of the Fc domain in Canakinumab and Rilonacept means that both drugs can be actively transported across the placenta by the neonatal Fc receptor in the second and third trimester and thus be exposed to the developing foetus in contrast to Anakinra that lacks the Fc domain.

### **Patients and methods**

A request for data was made in 2012 to members of the International Society for Systemic Autoinflammatory diseases. A data collection sheet was used to obtain standardized retrospective data including maternal age, autoinflammatory syndrome diagnosis, obstetric history, type and duration of IL-1 blockade, biochemical and clinical response to IL-1 inhibition, pregnancy duration and delivery mode. Infant data for APGAR (Appearance, Pulse, Grimace, Activity and Respiration) score, birth weight, congenital abnormalities, development, breast feeding status and age at last follow-up were collected. The study was approved by the Royal Free NHS Trust ethical committee, and

consent was obtained by the treating physician and indicated on the data collection sheet. Paternal exposure data were collected by retrospective review of case notes.

**Table 6.1: Licensed interleukin-1 antagonists and evidence for their use in pregnancy and lactation**

IL-1 Antagonist	Half-life	Animal data	Human Data	FDA Pregnancy Category†	Lactation
<b>Anakinra</b> (Kineret®, Sobi) recombinant human IL-1 receptor antagonist (IL-1 Ra)	5.7 hours [249]	No evidence of impaired fertility or fetal harm in rats or rabbits at doses > x25 human dose	5 completed pregnancies in Adult Onset Stills Disease (AOSD) [250, 251] 9 completed pregnancies in CAPS [252] See <b>Table 6.5</b>	B	IL-1 Ra is a normal component of breast milk. Single report; No adverse outcomes reported [251]
<b>Canakinumab</b> (Ilaris®, Novartis) human IgGkappa monoclonal antibody to IL-1Beta	29 Days [229]	No fetal abnormalities in Marmosets, delayed cranial ossification in mice but no teratogenicity. [253]	No data	C	No data
<b>Rilonacept</b> (ARCALYST®, Regeneron Pharmaceuticals) Dimeric, glycosylated fusion protein composed of the extracellular domains of the interleukin 1 receptor and an accessory protein IL-1-RAcP fused to the Fc domain of human IgG1	8.6 days [254]	Teratogenic in Cynomolgus monkeys; increased incidence of stillbirths, lumbar ribs, fusion of ribs and thoracic vertebral bodies and arches [255]	No data	C	No data

†The United States Food and Drug Administration (FDA) Pregnancy Category B: animal studies have failed to demonstrate a risk to the foetus, there are no adequate studies in pregnant women; Category C: There are no adequate and well-controlled studies in pregnant women. Based on animal data, may cause foetal harm.

## **Results**

43 pregnancies exposed to IL-1 inhibitors were identified. These came from seven countries, including 14 canakinumab-exposed pregnancies, of which 8 were maternal (Table 6.2) and 29 anakinra-exposed pregnancies of which 23 were maternal (Table 6.3). We report the first data on paternal exposure to anakinra (n=6) and canakinumab (n=5) (Table 6.4). We report the outcome of 14 neonates breast fed by mothers taking anakinra (n=10) or canakinumab (n=4) for up to ten months duration, with no reported serious infections (Tables 6.2 and 6.3). There were no developmental abnormalities with median follow-up of 18 months (range 1 week to 10 years). There were no cases of rilonacept use in pregnancy.

In keeping with the known favourable safety and efficacy profiles of these medications, there were no reported serious infections in the mothers nor neonates and disease was in complete clinical and biochemical remission in all but three cases (detailed below)

### **Canakinumab**

Eight pregnancies, from seven women, were exposed to canakinumab and resulted in seven live births (Table 6.2). A single case of miscarriage occurred at six weeks to a 26-year-old mother with refractory Cogan Syndrome, with only a partial clinical and biochemical response to canakinumab at a dose of 150mg monthly. This was her second miscarriage, the first occurring on anakinra the previous year. Of the seven live births, mean maternal age was 24 years (range 16-32 years), all were in complete clinical and biochemical remission for CAPS (n=4), FMF (n=2), and one case of unexplained inflammatory illness. Pregnancies were uneventful, all reaching full term and normal birth weight;

mean 3.58kg (range 3.3-4.48kg). Data on mode of delivery were available for five cases, with three caesarean sections and two vaginal deliveries.

Duration of treatment and its relation to pregnancy differed in each case; two babies were conceived on canakinumab which was discontinued as soon as pregnancy was confirmed in the 1<sup>st</sup> trimester, at 8 weeks and 12 weeks respectively. Two mothers switched to anakinra, at 8 and 36 weeks, and one was treated from before conception to term with 300mg canakinumab 8 weekly, with last dose at 36/40.

Five babies were born to three fathers who were on long term treatment (median 24 (Range 6-73) months) at time of conception for CAPS (n=2) and TRAPS (n=1). This included two fathers who had CAPS complicated by AA amyloidosis and prior to effective treatment with anti-IL-1 agents (one each of anakinra and canakinumab) were confirmed infertile with severe oligospermia. 66% of the offspring were male (Table 6.4). At mean follow-up of 6.83 (range 4-10) years, no growth or developmental abnormalities have been identified.

Four babies were breast fed by mothers' who were prescribed regular canakinumab. There were no reported serious infections and no developmental abnormalities at a mean follow-up of 2.2 years (range 5 months to 4 years).

## **Anakinra**

29 pregnancies were exposed to anakinra in total, 23 through maternal exposure, resulting in the births of 28 infants (Table 3). Mean maternal age was 29 years (range 20-38 years). Maternal diagnoses were CAPS (12), adult onset Still's Disease (AOSD) (4), FMF (3), TRAPS (2), pericarditis (1), and Cogan syndrome (1). All patients were in complete clinical and biochemical remission with exception of the 2 women with AOSD and Cogan syndrome, whose diseases were less well suppressed. 39% of mothers took anakinra continuously from before conception to delivery and during the puerperium. Three mothers conceived on anakinra but discontinued it when pregnancy was confirmed at up to 16/40. Three women started anakinra during pregnancy; two were switched to anakinra from canakinumab before 8/40, and one started at 22/40 due to active inflammatory disease. A single miscarriage occurred, at 12 weeks gestation in a 25-year-old female with refractory Cogan syndrome; she had achieved only a partial clinical and biochemical response despite dose escalation of anakinra to 200mg daily, which she had taken before conception and throughout the first trimester.

A 29-year-old female with AOSD, who had a history of two miscarriages at 10 and 13 weeks and an ectopic pregnancy, delivered a healthy girl at 38 weeks, having started anakinra 100mg before conception and continued it until 25/40.

There was no history of infection in either the mothers or babies exposed to anakinra. Where data were available regarding mode of delivery, seven (60%) babies were born via spontaneous normal delivery, four by caesarean section and two deliveries were induced at between 35+1 (for vaginal bleeding)- 41+1 weeks.

All babies were born healthy with normal APGAR scores at 10 minutes and 50% were male. There was a single case of ectopic neurohypophysis with growth hormone deficiency and left renal agenesis in a baby boy born to a mother aged 30 years with AOSD. It was the mother's first pregnancy and she had corticosteroid refractory disease at the time of conception. Anakinra therapy began at nine weeks gestation and continued until elective caesarean section at 38+1/40 with excellent clinical and biochemical response. The infant was developing normally at time of last contact aged 15 months.

Ten babies were breast fed by mothers taking anakinra for up to ten months with no reported infections or developmental abnormalities.

Six babies were conceived whilst their fathers were taking anakinra. There were no congenital or developmental abnormalities reported at follow-up of between 4 weeks and 8 years (Table 6.4).



**Table 6.2 Canakinumab exposed pregnancy and breast-feeding outcomes**

Maternal age at pregnancy (years)	Diagnosis	Dose and duration of canakinumab	Dates and mode of delivery	Birth weight Kgs	APGAR Score	Gender of Infant	Development	Age at last contact	Mode of feeding
25	CAPS	150mg 8 weekly PC to 8/40	38 EI-CS†	3.54	10	Male	Normal	3 years	Bottle
32*	CAPS	150mg 8 weekly PC to PPT (12/40)	40 VD	4.48	10,10,10	Female	Normal	5 months	Breast
24*	CAPS	150mg 8 weekly until 36/40	40 NR	3.57	NR	Male	Normal	7 days	NR
16	CAPS	120mg single dose post conception prior to PPT	38 NR	3.29	9,9,10	Male	Normal	4 years	Breast
21	Un-SAID	300mg 8 weekly PC to D (last dose at 36/40)	39 VD	NR	10,10,10	Male	Normal	1 year	NR
21	FMF	150mg 4 weekly PC-D	37 EI-CS‡	3.3	“Normal”	Male	Normal	11 months	Breast
27	FMF	150mg 8 weekly PC to PPT 4/40	40 EI-CS‡	3.3	“Normal”	Female	Normal	3.5 years	Breast
26†	Cogan Syndrome	150mg 4 weekly PC-6/40	Miscarriage 6/40						

Kgs Kilograms, Un-SAID uncharacterized systemic autoinflammatory disease, PC prior to conception, PPT confirmation of pregnancy (positive pregnancy test) , D delivery, VD vaginal delivery, I-VD induced vaginal delivery, EM-CS emergency caesarean section, EL-CS elective caesarean section, NR not reported, CAPS Cryopyrin Associated Periodic Fever Syndromes, FMF Familial Mediterranean fever, AOSD Adult Onset Stills Disease, TRAPS TNF Receptor Associated Periodic Fever Syndrome, † due to gestational diabetes ‡ due to patient choice, \* denotes patient who received both canakinumab and anakinra during same pregnancy, †denotes same patient who received both canakinumab and anakinra in two separate pregnancies both resulting in miscarriage (see also Table 3)

**Table 6.3 Anakinra exposed pregnancy and breast-feeding outcomes**

Maternal age at pregnancy (years)	Diagnosis	Dose and duration of anakinra	Dates (weeks) & Mode of delivery	Birth weight (kg)	APGAR	Gender	Development	Age at last contact	Mode of Feeding
29	CAPS	50mg alt/days PC to D	39 I-VD	3.94	9,9,9	Male	Normal	4 years	Bottle
32	CAPS	50mg alt/days PC to D	39 VD	NR	NR	Female	Normal	2 years	Bottle
30	CAPS	100mg daily PC to D	41+1 VD	3.6	9,9,10	Male	Normal	2 years	Breast
32*	CAPS	100mg daily PPT to D	40 VD	4.48	10	Female	Normal	5 Months	Breast
24*	CAPS	100mg daily 36/40 to D	40 NR	3.57	NR	Male	Normal	7 days	NR
20	CAPS	100mg PC to PPT	36+6 NR	2.83	10,10,10	Male	Normal	10 weeks	Bottle
24	CAPS	100mg PC to D	38+6 EM-CS <sup>1</sup>	NR	NR	NR	Normal	6 months	NR
34	CAPS	100mg daily PC to 6/40	40 EI-CS <sup>2</sup>	NR	NR	Male	Normal	18 months	NR
25	CAPS	100mg daily PC to D	NR	NR	NR	Male	Normal	8 years	Breast 10/12
35	CAPS	100mg daily Dates NR	40+1 NR	NR	NR	Female	Normal	NR	NR
38	CAPS	100mg Dates NR	NR	NR	NR	Female	Normal	NR	NR
28	CAPS	100mg Dates NR	NR	NR	NR	Female	Normal	NR	NR
33	FMF	100mg daily PC-D	36+1 EI-CS <sup>3</sup>	2.17	8	Male	Normal	2 years	Breast
28	FMF	100mg daily 12/40 to D	40 VD	3.17	10	Female	Normal	19 months	Breast 3/12

24	FMF	100mg daily PC-D	36 VD	1.6	7	Female	Normal	9 months	Breast
38	Idiopathic Pericarditis	100mg daily PC to PPT	38+2 VD	2.93	8,9,9	Male	Normal	12 weeks	Bottle
29	AOSD	200-300mg daily PC-16/40	37	2.45	9	Female	Normal	10 months	Bottle
31	AOSD	100mg daily 22/40-32/40 Then alt days to 33/40	35+1 NR	2.02	9	Male	Normal	18 months	Breast
30	AOSD	100 mg daily 9/40 to D	38+1 EI-CS <sup>2</sup>	NR	7,8,9	Male	- Left Renal Agenesis - Ectopic Neurohypophysis with growth hormone deficiency	1 year 3months	Breast 3/12
29	AOSD	100mg daily NR	38 VD	3.06	Normal	Female	Normal	9 months	Breast
29	TRAPS	100mg daily PC to D	41 I-VD	3.23	9,9,9	Male	Normal	8 months	Breast
29	TRAPS	100mg PC to D	NR	NR	NR	Female	Normal	NR	NR
25†	Cogan Syndrome	200mg daily PC-12/40	Miscarriage 12/40						

PC prior to conception, PPT confirmation of pregnancy (positive pregnancy test) , D delivery, VD vaginal delivery, I-VD induced vaginal delivery, EM-CS emergency cesarean section, EL-CS elective cesarean section, NR not reported, CAPS Cryopyrin Associated Periodic Fever Syndromes, FMF Familial Mediterranean fever, AOSD Adult Onset Stills Disease, TRAPS TNR Receptor Associated Periodic Fever Syndrome, mg miligrams, kg kilograms, <sup>1</sup>failure to progress, <sup>2</sup>patient choice, <sup>3</sup>per vaginal bleed started at 34/40, \* denotes patient who received both canakinumab and anakinra during same pregnancy, †denotes same patient who received both canakinumab and anakinra in two separate pregnancies both resulting in miscarriage (see also Table 6.2).

**Table 6.4 Pregnancies with paternal exposure to anakinra or canakinumab at conception**

Diagnosis	Number of offspring exposed	Drug/Dose	Drug duration prior to conception (months)	Congenital Abnormalities	Developmental Abnormalities	Gender	Age at last contact
AOSD	1	Anakinra 100mg daily	Not known	None	None	Female	4 weeks
AOSD	1	Anakinra 100mg daily	Not Known	None	None	Female	10 months
CAPS	3	Canakinumab 150mg 8 weekly	248 75	None None None	None None None	Male Male Female	10 years 8 years 4 years
CAPS	1	Anakinra 100mg daily	25	None	None	Male	8 years
CAPS	1	Canakinumab 150mg 8 weekly	23	None	None	Male	7 years
TRAPS	2	Anakinra 100mg alternate days	3 57	None None	None None	Male Female	5 years 6 months
TRAPS	1	Anakinra 100mg daily	66	None	None	Male	16 months
TRAPS	1 (IVF)	Canakinumab 150mg 8 weekly	24	None	None	Female	2 years

AOSD Adult Onset Stills Disease, CAPS Cryopyrin Associated Periodic Fever Syndromes, TRAPS Tumour Necrosis Factor Receptor Associated Periodic Fever Syndrome, IVF In Vitro Fertilization.

## **Discussion**

Potential parents greatly wish to minimize any risks to a future child and the decision to proceed with pregnancy on novel therapies of uncertain safety remains extremely difficult for the family and their physicians. SAIDs frequently relapse rapidly after treatment withdrawal and many patients on long-term anti-IL-1 agents can only tolerate very brief suspension of treatment. Consequently, simple symptomatic management throughout pregnancy is not generally feasible. In addition, uncontrolled inflammatory activity has deleterious effects on fertility and pregnancy outcomes; poorly controlled FMF is associated with a modest increase in foetal loss, preterm delivery, low birth weight and caesarean section[256]. Male fertility is also reduced in the presence of chronic inflammation and testicular AA amyloidosis is a recognized cause of azoospermia[257]. In two fathers reported here, long term control of CAPS, first with anakinra and then canakinumab, resulted in regression of amyloid that was evident on serial SAP scintigraphy, resolution of associated nephrotic syndrome and reversal of previous infertility. Uncontrolled inflammatory disease carries its own risks to fertility, the foetus and the mother and these should be included in preconception parental counselling

The data reported here substantially increases the evidence base for anakinra and canakinumab use prior to conception, during pregnancy and breast-feeding. They include the first human data on canakinumab-exposed pregnancies and the largest reported series receiving anakinra. In general, the data are reassuring for both agents and for paternal and maternal exposure. There are no data on rilonacept and we would not advocate its use in pregnancy based on teratogenicity in animals.

There was a single case of congenital abnormality in a boy born to a mother with active refractory AOSD. AOSD is the most heterogeneous of diseases included in the study with no known genetic susceptibility and its diagnosis is based on relatively loose criteria. The patient had active disease at the time of conception and had had considerable prior treatment including azathioprine and high-dose corticosteroids. Anakinra was initiated at nine weeks gestation. Prenatal screening identified an ectopic neurohypophysis, resulting in growth hormone deficiency, and a single kidney. Renal tract abnormalities, including unilateral renal agenesis, have been reported to occasionally occur in individuals with ectopic neurohypophysis[258]. Moreover, the latter condition has been associated with gene variants in the sonic hedgehog (SHH) pathway, [259] and SHH pathway molecules are present in the developing human renal tract [260]. Our case is important, as it is now the second report of renal agenesis in anakinra-exposed pregnancies. Chang *et al* reported a twin pregnancy in which one foetus died *in utero* and had bilateral renal agenesis[252]. The surviving twin had no developmental abnormality and was well at last reported follow-up. The mother was 19 years old in her first pregnancy having received anakinra for eight years for CAPS. She was prescribed a higher dose of anakinra at conception than in our cohort, at start of pregnancy 239 mg, increasing to 300 mg daily. She also had a history of diabetes mellitus both this and the twin pregnancy are known risk factors for renal tract abnormalities [261].

Wiesel *et al* reported unilateral renal agenesis in 58 of 709,030 live births, stillbirths, and induced abortions, and 95 cases of bilateral agenesis in the same population [262]. Therefore, one case of either renal malformation among 36

anakinra-exposed fetuses is higher than the expected frequency. Whilst experimental evidence for a direct role of the IL-1 axis in normal or abnormal renal development is currently lacking, reassuringly in an experimental murine model of a hostile uterine environment in which IL-1 is known to be elevated, inhibition of IL-1 may improve the likelihood of implantation and prevent pregnancy loss[263], [264] Future research should seek whether IL-1 and its receptors are expressed in the normal and malformed renal tract, and the spatial and temporal relation of these molecules to those in the SHH pathway.

The current study has a number of limitations; it was retrospective and is therefore prone to errors such as recall bias and variable data collection between centres. Nonetheless this represents the best data to date and highlights the pressing need for prospective data collection using existing registries with rapid feedback of relevant information to our patients and their families.

Overall the data show that the use of anakinra and canakinumab appears well tolerated, and efficacious during pregnancy and in males at conception. Serious questions remain about the increased incidence of renal tract abnormalities seen and suggests that this should be discussed with all potential parents at preconception counselling. We acknowledge that reported numbers remain small with 43 maternal cases in the literature (summarized in Table 6.5).

Our current practice is to advise that paternal use of IL-1 antagonists at conception appears safe, albeit based on limited clinical experience. We offer counselling for prospective parents before conception in all cases and discuss the option of temporarily ceasing IL-1 inhibiting treatment, whilst highlighting that this approach is often poorly tolerated and may carry risks to conception

and foetal growth associated with uncontrolled inflammation. For women who are unable or do not wish to stop IL-1 antagonists, there are two options; (i) not to conceive a child, and (ii) to proceed with conception and pregnancy following an informed discussion on risk-benefit. For women who do wish to become pregnant, we favour the use of anakinra at the current time, based on clinical experience to date, its homology with natural IL-1Ra, and its short elimination half-life. A theoretical concern regarding canakinumab is the possibility of active transport of IgG monoclonal antibodies across the placenta from 30 weeks and combined with the prolonged half-life of immunoglobulins in neonates, we suggest that canakinumab should not be administered from 22 weeks gestation in line with EULAR recommendations and should be avoided where possible.



**Table 6.5 Summary of previously published data on anakinra use in pregnancy**

Reference	Maternal Diagnosis	Treatment and dose	Delivery	Birth weight (kgs)	APGAR Score	Gender	Development	Duration of follow up	Method of feeding
<b>Berger 2009</b> [251]	AOSD	Anakinra 100mg daily 2 years prior to and through pregnancy and delivery	VD	2.7 kg	7,8,9	Female	Normal	4 months	Breast
<b>Fischer Betz 2011</b> [265] Case 1	AOSD	Anakinra 100mg daily, 1 year prior to pregnancy and throughout	VD 39/40	3.1 kg	NR	Male	Normal	NR	Bottle
<b>Fischer Betz 2011</b> Case 2	AOSD	Anakinra 100mg daily 12/40 onwards	CS 36/40	2.8 kg	NR	Male	Normal	NR	Bottle
<b>Chang 2014</b> [252] Case 1	CAPS	Anakinra	VD 41/40	3.74 kg	NR	NR	NR	NR	Bottle
<b>Chang 2014</b> Case 2	CAPS	Anakinra	VD 41/40	3.63 kg	NR	NR	NR	NR	Bottle
<b>Chang 2014</b> Case 3	CAPS	Anakinra	VD 38/40	3.40 kg	NR	NR	NR	NR	Breast 3 months

<b>Chang 2014</b> Case 4	CAPS	Anakinra	VD 37/40	3.46 kg	<b>NR</b>	<b>NR</b>	<b>NR</b>	<b>NR</b>	<b>Bottle</b>
<b>Chang 2014</b> Case 5	CAPS	Anakina	VD 37.5/40	2.98 kg	<b>NR</b>	<b>NR</b>	<b>NR</b>	<b>NR</b>	<b>Bottle</b>
<b>Chang 2014</b> Case 6	CAPS	Anakinra	VD 39/40	3.35 kg	<b>NR</b>	<b>NR</b>	<b>NR</b>	<b>NR</b>	<b>Bottle</b>
<b>Chang 2014</b> Case 7	CAPS	Anakinra	CS 40/40	4.14 kg	<b>NR</b>	<b>NR</b>	<b>NR</b>	<b>NR</b>	<b>Breast</b> <b>1Year</b>
<b>Chang 2014</b> Case 8*	CAPS	Anakinra	VD 38.7/40	2.64 kg	<b>NR</b>	<b>NR</b>	<b>NR</b>	<b>NR</b>	<b>Breast</b> <b>&lt; 1 month</b>
<b>Chang 2014</b> Case 9	CAPS	Anakinra	CS "term"	3.52 kg	<b>NR</b>	<b>NR</b>	<b>NR</b>	<b>NR</b>	<b>Bottle</b>

CAPS Cryopyrin Associated Periodic Syndrome, VD Vaginal Delivery, CS Cesarean Section, NR not recorded \* twin dichorionic-diamniotic pregnancy with fetal demise of one fetus with bilateral renal agenesis, surviving twin had no congenital abnormality.

## **Chapter Seven:**

### **Deficiency of Adenosine Deaminase 2 (DADA2)**

## Introduction

In March 2014, in the same issue of the New England Journal of Medicine, two separate groups published a syndrome of early-onset vasculopathy, haemorrhagic and ischaemic stroke and both clinical and histopathological evidence of Polyarteritis Nodosa (PAN) vasculitis, linked to loss of function mutations in a common gene located on the q arm of chromosome 22 at position 11.1[155, 156]. The gene, known then as Cat Eye Syndrome Chromosome Region, Candidate gene 1 (CECR1), had been previously associated with the Cat Eye Syndrome, a rare congenital disorder of variable phenotype characterised by ocular colobomata, down sloping palpebral fissures, anal atresia, hypertelorism, periauricular skin tags, urogenital and cardiac defects[266].

The CECR1 gene encodes the enzyme adenosine deaminase 2 (ADA2), a dimeric extracellular enzyme, that is involved in the purinergic signalling pathway by irreversibly converting 2'-deoxyadenosine to 2'-deoxyinosine[157]. Patients with a variety of mutations in this gene have been shown to have very low or absent ADA2 activity in the blood[158]. The syndrome was termed Deficiency of ADA2 (DADA2), the CECR1 gene renamed as ADA2, and since 2014 over 200 cases have been published in the literature. These cases describe a highly variable phenotype of vasculopathy, vasculitis and immunodeficiency, the latter clinical manifestation of importance given that ADA1 deficiency is the cause of Severe Combined Immunodeficiency and is fatal if not treated with enzyme replacement, gene therapy or stem cell transplantation[159].

ADA1 and ADA2 both play a pivotal role in regulating the signalling molecule adenosine, but are different in their structure, function and expression. ADA1 is a ubiquitous monomeric intracellular protein with a clear, but thus far cryptic, role in the development of adaptive immunity[267]. Deficiency of ADA1 has no known vascular phenotype. In contrast, the ADA2 protein is highly expressed by myeloid cells and is secreted by activated monocytes undergoing differentiation into macrophages and dendritic cells but is not secreted by the vascular endothelium [268, 269]. ADA2 additionally exhibits growth-factor like ability by

inducing T-cell dependent differentiation of monocytes, possibly through its N-terminal domain that is notably absent in the ADA1 molecule which appears to have no similar action[270].The absence of an identifiable murine ADA2 ortholog has impeded *in vivo* studies of ADA2 function thus far. Adenosine Deaminase Growth Factors (ADGFs) are present in other organisms and share high sequence homology with human ADA2. The absence of ADGF in *Xenopus laevis* embryos using morpholino oligonucleotides causes a reduction in the body size and abnormalities of the body axis [271]. The injection of adenosine into early stage *Xenopus* embryos causes similar changes, both suggesting that extracellular adenosine concentrations may regulate vertebrate embryogenesis, a finding further demonstrated in mice with transgenic expression of ADA2 resulting in defects in organogenesis (heart and kidney)[272]. Thus, ADA2 not only has a catalytic role but also a role in cell proliferation and differentiation.

The vasculopathic phenotype of DADA2 patients suggests that ADA2 also has a crucial role in endothelial integrity, whilst not being expressed by the endothelium itself. The pathogenesis of this again remains uncertain but is clearly demonstrated in the initial description of the disease, whereby *cecr1b* knock-down Zebrafish embryos revealed intracranial bleeding and neutropenia [156](Figure 7.1). The same paper demonstrated disruption of the cell junction in cocultured human microvascular endothelial cell-layers in those with ADA2 deficiency and staining of DADA2 patient skin and brain biopsies with anti-CD31 antibodies revealed substantial endothelial damage. Endothelial-cell activation was also demonstrated by E-selectin staining.

**Figure 7.1: Cecr1b-knockdown Zebrafish**

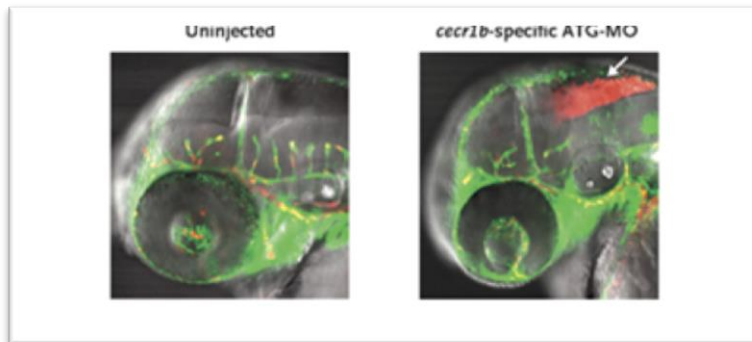

Figure showing intracranial haemorrhage in *cecr1b*-knockdown Zebrafish [156], a very visual illustration of what may happen in the brains of those with DADA2 and suggesting that ADA2 plays a crucial role in endothelial integrity.

ADA2 is actively secreted by monocytes and, via a T-cell dependent mechanism, induces the differentiation into macrophages or dendritic cells. High levels of ADA2 can be found in those with active inflammation, perhaps suggesting a role in regulating extracellular adenosine at sites of inflammation. ADA2 has even been postulated as a biomarker in several diseases such as tuberculosis and hepatitis [273, 274]. Adenosine signalling dampens the inflammatory response in acute disease states preventing end organ damage but if adenosine levels remain chronically elevated, which may occur at a cellular level in those with DADA2, high levels of adenosine may activate inflammatory pathways promoting tissue injury and fibrosis [275].

Skin biopsies analysed from patients with DADA2 demonstrates interstitial and perivascular inflammatory infiltrate (composed of MPO+ neutrophils and CD68+ macrophages, and CD3+ lymphocytes respectively) and shows strong TNF- $\alpha$ , interleukin-1 $\beta$ , and nitric oxide synthetase staining indicating inflammation [156]. However, clinically there appears to be a spectrum of serologically detectable inflammation, with cases in the literature with significant symptoms such as fever and vasculitis with relatively normal markers of acute phase response, as well as cases with significant inflammation leading to renal AA amyloidosis[276].

In those with deficiency of ADA2 increased concentrations of pro-inflammatory cytokines such as TNF-  $\alpha$  and a reduction in the number of lymphocyte subsets has been demonstrated as well as a polarization towards the pro-inflammatory M1 macrophage subset [277].

The DADA2 syndrome was initially considered to be primarily a monogenic vasculitis with a phenotype similar to PAN, however, with time it is increasingly recognised that there is a broad haematological phenotype and that the clinical picture of this disease is highly variable even within families with the same mutation [99, 158, 278].

DADA2 does appear to be an autosomal recessive disorder but a carrier state is also recognised by some with lower levels of ADA2 activity measurable compared to age matched controls, and a later onset of milder symptoms including migraine, stroke in the fourth and fifth decades and livedoid rash, although this is controversial [279, 280]. To date 61 disease causing mutations have been described, most of which are missense variants, and are either novel or found at low allele frequency in public genomic databases consistent with the prevalence of other recessive rare disease causing mutations [281]. The majority of patients with DADA2 are compound heterozygous for missense mutations. The most common disease variants described to date are: p.Gly47Arg (p.G47R), p.Gly47Ala (p.G47A), p.Arg169Gln (p.R169Q), p.Tyr453Cys (p.Y453C). The homozygous p.G47R mutation has been most associated with the PAN phenotype but there is little other phenotype-genotype correlations[281].

In the initial description of DADA2 patients a PAN-phenotype with a mild immunodeficiency is recognised with low IgM as the predominant feature and increased rates of B-cell death compared to healthy controls[156]. However, there appears to be a distinct immunodeficiency phenotype of DADA2 patients, who can present at any age, although most commonly in childhood, with a clinical range from mild immunodeficiency to severe cytopenias and bone marrow failure. This suggests an additional regulatory role for ADA2 in the activation and survival of immune cells. It has been shown that ADA2 binds to proteoglycans and possibly adenosine receptors on distinct subtypes of immune cells; neutrophils, CD16+ monocytes, B cells, NK cells, and regulatory T cells expressing CD39 and lacking the receptor for ADA1[270]. In a description of two related patients with the same homozygous mutation, inflammation, lymphoproliferation and immunodeficiency, profiling of immune cells showed increased CD4+ T-cells, increased naïve B-cells numbers, reduced

plasmablasts and memory cells and reduced CD8+ T-cells[282]. This suggests a defect in B-lymphocyte differentiation and / or T-cell provision of help. However, like with the PAN-like phenotype, there appears to be a wide range of phenotypic variability in haematological disease even between siblings with the same genotype[99].

In summary, the physiological role of ADA2 appears to extend beyond its role as a catalyst for the deamination of adenosine to inosine. The identification of individuals with deficiency of this enzyme, has in a few short years, allowed us to explore the function of ADA2 as a growth factor, in immune regulation and in maintaining the integrity of the vascular endothelium. However, the mechanisms of these functions remain poorly understood and with cases increasingly diagnosed, many questions remain.

A seeming omission from this introduction is a detailed overview of the broad phenotype of DADA2 and the diagnosis and management of this newly described disease. This is intentional as it is explored in detail in this chapter. Part 1 of this chapter focuses on the description of the novel Pro251Leu homozygous phenotype in a highly consanguineous family, demonstrating the wide variability in clinical presentation even within families with the same homozygous mutations. Part 2 enlists international expert opinion to explore consensus on the diagnosis, investigation and management of this newly describe disease.



## **Phenotypic characterisation of the Pro251Leucine mutation**

### **Introduction**

#### **The phenotype of DADA2**

The initial descriptions of DADA2 in 2014 depicted a phenotype of vasculopathy, vasculitis and neurological manifestations[155, 156]. Since that time the description of the disease has significantly evolved most notably with numerous haematological and immunological consequences of mutations in the ADA2 gene.

#### **Cutaneous manifestations**

Cutaneous manifestations of DADA2 are now well recognised[283]. Livedo racemosa is described and biopsies of this loose livedoid rash demonstrate perivascular T-cell infiltration and infiltration of the interstitium with neutrophils and macrophages but a classical PAN-like necrotising arteriitis is also reported[155]. Raynaud's phenomenon appears common and many cases of more extensive vasculopathy with digital necrosis and cutaneous ulcers have been described[156].

#### **Neurological manifestations**

Early onset stroke, under the age of ten, typically a lacunar infarct (sparing white matter) is now well described, although haemorrhagic strokes are recognised also, particularly after infarction. Navon Elkan *et al* demonstrated both erythrocyte extravasation and endothelial cell activation in brain biopsies in their initial publication[155]. There is a single report of DADA2 presenting as spastic paraplegia with cranial nerve dysfunction and systemic vasculitis [284]. Unpublished data from the NIH shows no incidence of stroke in those treated with anti-TNF therapy which raises many questions regarding the need for treatment in asymptomatic carriers which is explored later in this chapter (personal communication).

## **Haematological manifestations**

Haematological manifestations were largely absent from the original descriptions of the disease, but it is increasingly evident that there is a broad haematological phenotype ranging from mild immunodeficiency to bone marrow failure. These haematological manifestations have been reported both with and without clinical evidence of inflammation or PAN-like vasculitis but which, unusually for haematological disease, appear to also respond to anti-TNF therapy[99, 285, 286]. Autoimmune haemolytic anaemia has been described as has Pure Red Cell Aplasia as the only presenting feature in patients with homozygous ADA2 mutations[286, 287] with features similar to Diamond-Blackfan Anaemia (a congenital red cell aplasia) but without the ribosomal mutations and with no congenital malformations. Thrombocytopenia and severe neutropenia have been reported[288].

Lymphadenopathy has been reported in numerous cases, both with and without vasculopathy including a clinical picture resembling autoimmune lymphoproliferative syndrome (APLS)[285]. In two cases of lymphoproliferation, T cell large granular leukaemia has been described[289].

Haematological stem cell transplantation has been trailed in several cases and has been shown to not only reverse the haematological pathology but also vasculopathy by restoring normal range plasma ADA2 activity levels[282].

## **Immunodeficiency and Autoimmune manifestations**

Hypogammaglobulinaemia and low serum IgA and IgM were reported in associated with ADA2 mutations in the initial descriptions of the disease and subsequently feature commonly in case series [155, 156, 281].

Since that time there have been published reports of patients identified with ADA2 mutations following unusual or chronic infections with opportunistic organisms[290]. This suggests a defect with the B cell compartment, demonstrated further in a cohort of patients with antibody deficiency 11 of 181 (6%) had homozygous or compound heterozygous mutations in the ADA2 gene thought to be responsible for their presentation and 10 of the 11 cases had low memory B cells[291].

The autoimmune phenomena in DADA2 are less common but positive autoantibodies including anti-phospholipid and anti-nuclear antibodies have been reported[155, 156]. This is important due to the new association of ADA2

mutations with Sneddon's syndrome; the syndrome of adult-onset stroke and livedo with antiphospholipid antibodies[292].

### The Pro251Leucine Phenotype

The initial descriptions of the phenotype and the identification of a single gene led many to look retrospectively through their cases to identify those who may have a diagnosis of DADA2. In late 2014, our team identified a young male patient in whom we identified a homozygous mutation at position 251 in the catalytic domain of the ADA2 protein (Figure 7.2). This mutation has been reported in the compound heterozygous state only by Navon Elkan *et al* [155]. The index case was from a highly consanguineous family and had three siblings. The adult siblings (two brothers) and his parents were referred for assessment to the National Amyloidosis Centre.

**Figure 7.2: The ADA2 Protein**

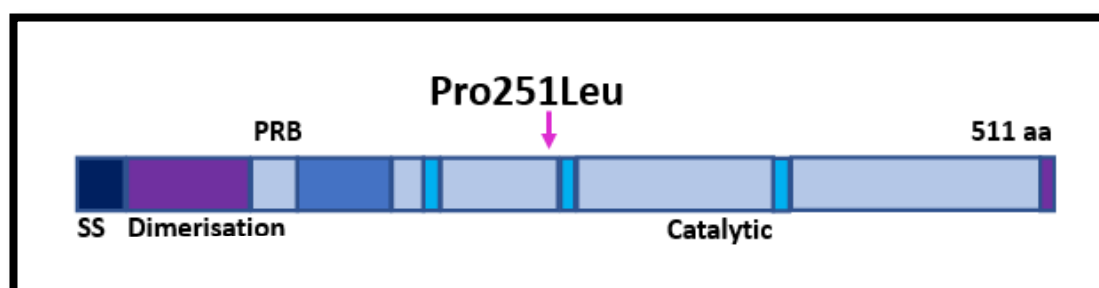

The ADA2 protein showing location of the Pro251Leu mutation, SS = signal sequence domain, dimerization domain, PRB = putative receptor binding domain, catalytic domain.

*In silico* modelling by Navon Elkan and colleagues demonstrated that there is a hairpin turn at residues 250-261 of ADA2 which is critical in defining the shape of the active site[155]. The Pro251Leu mutation would introduce a proline residue at 251 which would introduce flexibility and a large hydrophobic group, causing disruption to the critical active site of the enzyme [155].

## **Methods**

### **Patients**

Prospective clinical assessment of adult family members with the same mutation in the ADA2 gene referred to the NAC.

### **Imaging**

All images were acquired on clinical grounds using standard techniques at the Royal Free Hospital NHS Trust, London.

### **Genetic analysis**

Sequencing of the ADA2 gene was performed in the index case and then family members who consented as part of his clinical care at Great Ormond Street Hospital, London, using Sanger sequencing on an Applied Biosystems 3730 DNA Analyzer.

### **ADA2 activity levels**

My work in this field led to a collaboration with a group from Coimbra University, Portugal. Plasma ADA2 activity levels were assayed in three of the Pro251Leu kindred as part of a study on the neurological condition, Sneddon's syndrome [292]. Dr Gustavo Santo of Coimbra University performed the assay, using a modified technique from Muraoka and colleagues[293]. Blood samples were collected from all participants into lithium heparin tubes. The tubes were centrifuged at 1,500 g at 4 °C for 10 min and plasma was separated and frozen at -80 °C until analysis. Total ADA-T was determined through a commercial method (Diazyme) based on the conversion of adenosine into inosine and further into hypoxanthine (by purine nucleoside phosphorylase) and into uric acid and hydrogen peroxide (by xanthine oxidase). The conversion of hydrogen peroxide by peroxidase into the quinone dyes 4-aminoantipyrine and N-ethyl-N-(2-hydroxy-3-sulfopropyl)- m-toluidine was then monitored at 550 nm in a thermostatised spectrophotometer at 37 °C (UVIKON 933 UV/Visible). ADA2 activity was measured by the same method, in the presence of 0.1 mM of erythro-9-(2-hydroxy-3-nonyl) adenine hydrochloride (EHNA, Sigma), a potent selective inhibitor of ADA1. ADA1 activity was then calculated by subtracting ADA2 activity from total ADA activity. Each sample was run in duplicate and 2 control samples (with high and low levels of ADA activity) were assayed in each day for internal quality control. The intra-assay coefficient variation, calculated

from 6 repeats, was 6.4%, and the inter-assay coefficient variation, calculated for 13 runs performed, was 5.5%.

## **Results**

### **Index case**

A male of Pakistani origin but born in the U.K. He had initially presented aged one year with an intermittent livedoid rash, recurrent fever and ischaemic left little finger tip. He was managed locally to his home, initially as an infective episode. Aged three he then suffered an ischaemic stroke resulting in a hemiparesis. At time of stroke he had a fever and a CRP rise of 20-30 mg/L. He was transferred to great Ormond Street Hospital where a rash on his feet was noticed and biopsied. This revealed a necrotising vasculitis with polymorphs and he was diagnosed with Polyarteritis Nodosa. He was treated initially with steroids, intravenous cyclophosphamide and azathioprine. He made a significant recovery from the stroke but developed an axonal polyneuropathy that did not significantly affect his mobility. In 2014, at the age of 11-years, Sanger sequencing identified homozygous mutations, Proline to Leucine at position 251 of the ADA2 gene, and a diagnosis of DADA2 was made. Due to the evolving literature that, unusually for a vasculitis, DADA2 may respond to TNF- $\alpha$  inhibition, he was started on anti-TNF in the form of intravenous infliximab. This was stopped after two years of clinical and biochemical remission, but he then developed fever, malaise and worsening livedoid rash and anti-TNF was re-started with resolution of symptoms, and he continues to receive this treatment at censor.

### **Parents**

The mother and father of the index case are both of Pakistani origin and born in Lahore. They are second cousins and the mother's grandparents were first cousins (Figure 7.3). To their knowledge there was no family history of stroke, early onset stroke, livedo or vasculitis.

Gene sequencing revealed the father has a single heterozygous mutation at position 251 of the ADA2 gene. He was 40 years of age at time of study, working in a clerical job and with no significant past medical history. He had no symptoms of ill health and entirely normal clinical examination.

The mother aged 41 years was found to be homozygous for Pro251Leu mutation. She is a housewife and describes lifelong livedoid rash and significant migraine. Over the past 5 years she has developed a right-hand paraesthesia and episodes of intermittent fever. All pregnancies (n=4) were complicated by hypertension and ankle oedema. Clinical examination was remarkable only for right-median nerve entrapment neuropathy (carpal tunnel syndrome).

**Figure 7.3: Pedigree diagram of Pro251Leu family, including genotype status of all available relatives**

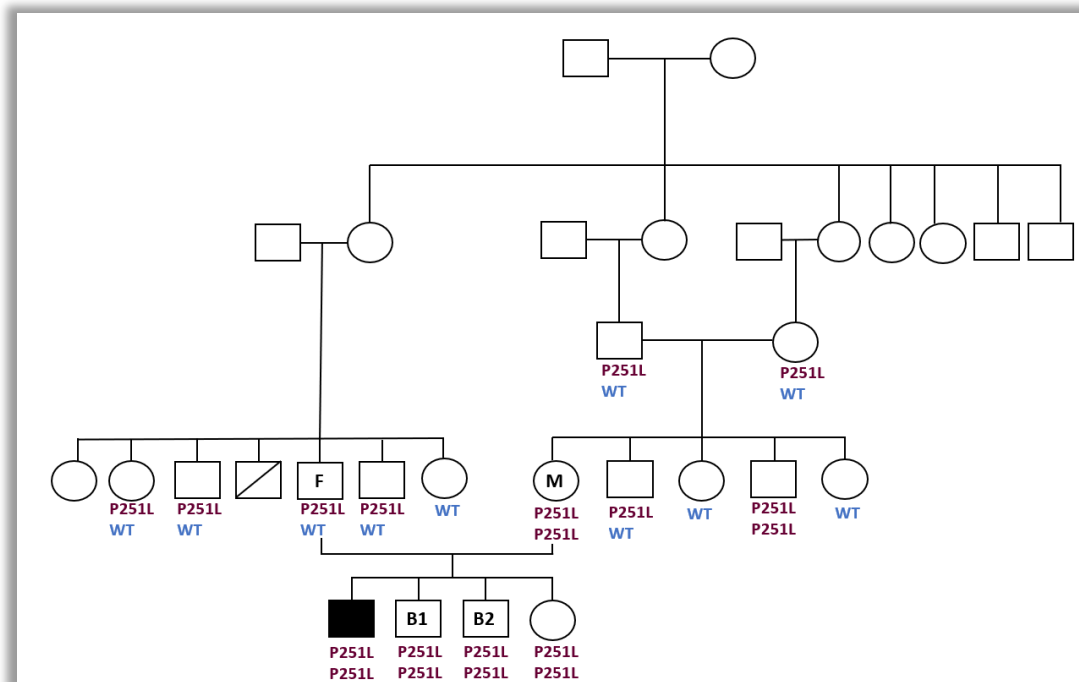

M denotes Mother, F Father, B1 Brother 1, B2 Brother 2, WT Wild Type. This has been adapted and modified based on history taking from the patients from a manuscript I co-authored [158].

## Siblings

A younger sister (aged 6 years) also homozygous for Pro251Leu was not seen or examined at her parents request but was reportedly asymptomatic.

### Brother 1

A 21-year-old university student at time of study. He had a history of a self-limiting episode diagnosed as Henoch-Schoenlein purpura ten years previously. There has been a single episode diagnosed as testicular torsion with spontaneous resolution. 2 years prior to study he was admitted to his university hospital with an episode of fever, ankle swelling, livedo reticularis, diarrhoea, weight loss and night sweats (Figure 7.4). All investigations at the time, including inflammatory markers, were negative or normal. Symptoms subsequently resolved without treatment. At time of study symptoms were mild; occasional migrainous headache, and cold or exercise induced livedo. Clinical examination was unremarkable.

**Figure 7.4: Photographs of Brother 1 during disease exacerbation showing livedo racemosa and arthritis**



Brother 1's own photographs used with permission showing right ankle swelling (left) and livedoid rash (right) on the forearm during an acute episode.

**Brother 2:** A 17-year-old A-level student, with a history also remarkable for testicular torsion, post-prandial pain and diarrhoea, especially after fatty foods. He denied fever but reported rare episodes of night sweats. He described exercise and cold-induced livedo. Clinical examination was normal.



The four adult family members underwent routine blood testing (Full Blood Count, Urea and Electrolytes, Liver Function Tests, ESR, Immunoglobulins, and serial CRP and SAA measures – six samples two weeks apart), and non-invasive magnetic resonance (MR) angiography of the brain as well as MR brain. The results of their investigations are found in Table 7.1 and Figure 7.5.

**Table 7.1: Baseline characteristics of first-degree family members with ADA2 mutations**

<b>Family Member</b>	<b>Serial SAA mg/L (range)</b>	<b>Serial CRP mg/L(range)</b>	<b>IgM g/L</b>	<b>Creatinine/EGFR <math>\mu\text{mol/Lml/}</math> and <math>\text{min}/1.73 \text{ m}^2</math></b>	<b>BP mm/Hg</b>	<b>Urine Dipstick</b>
Brother 1	5.4-12.2	2-4	0.6	86/100	141/63	No blood No protein
Brother 2	<3.5-3.9	<1-2	0.4	78/100	109/59	No blood No protein
Mother (BMI 36)	8.7-12.8	8-9	0.6	72/82	119/57	No blood No protein
Father	4.4-6.8	1-3	0.8	81/100	149/92	No blood No protein

**Figure 7.5: Baseline imaging in first-degree family members with ADA2 mutations**

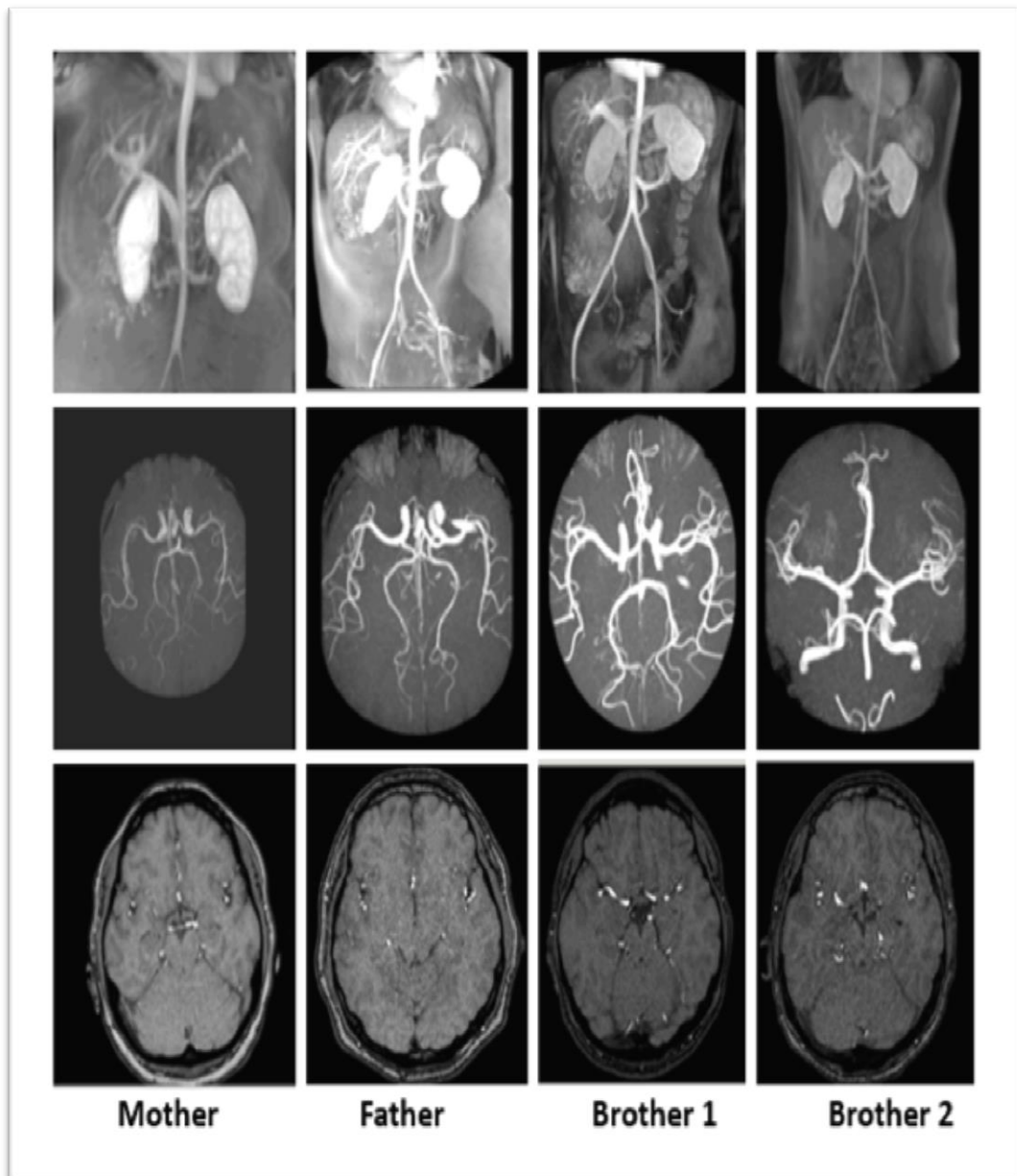

Magnetic resonance angiography of the viscera (top row), brain (middle row) and Magnetic resonance imaging of the brain in the four family members. All investigations were normal.

Figure 7.6: Plasma ADA2 activity levels compared to 13 healthy adult controls with homozygous wild type ADA2 genotypes

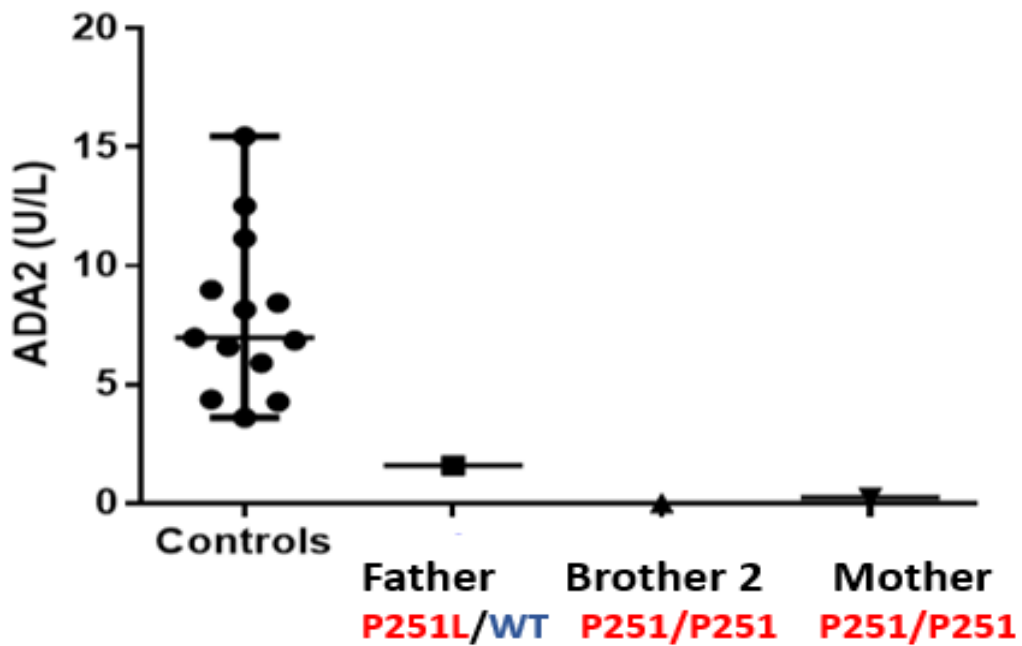

Samples were sent for analysis to Coimbra University, Portugal. Analysis performed by Dr G Santo. Controls (n=13) = 7.95 ± 3.44 U/L; Father = 1.59 U/L; Brother 2 = undetectable; Mother = 0.24 U/L. Both homozygotes (Brother 2 and Mother) have very low/undetectable ADA2 levels. Father is heterozygous and has lower ADA2 activity levels than the controls. WT = Wild Type.

**Table 7.2: Summary characteristics of published Pro251Leu/Arg169Glu compound heterozygotes from Navon Elkan *et al* 2014[155]**

Sex	Age at last follow up (years)	Age at onset (years)	Clinical Features	Treatment	Response
Female	30	2	Stroke Livedo Myalgia Hypertension PNS dysfunction Renal artery occlusion	Cyclophosphamide Azathioprine Methotrexate Anticoagulation Statin	Persistent hemiparesis Skin and neuropathy in remission
Female	19	7	Stroke Myalgia	Cyclophosphamide Azathioprine Anti-platelet agents Statin	Remission
Male	15	13	Stroke	Etanercept Azathioprine	Remission
Male	9	2	Livedo Myalgia	Etanercept	Remission Persistent livedo lower limbs

These cases were from a German family of five siblings, one asymptomatic with neither mutation and four detailed with significant manifestations of ADA2 deficiency. The father was heterozygous for the Pro251Leu and, like the father in our cohort, was asymptomatic. It is not known whether he underwent any investigations.

## Discussion

We have described a family of Pakistani origin with one sibling significantly affected by DADA2 and four other family members with the same Pro251Leu homozygous mutation. The parents and second cousins and the maternal grandparents were first cousins, explaining the homozygosity of the mother and all four children. The mother has vague symptoms of headache and livedo and no inflammation, however, she has very low ADA2 activity levels in her plasma. Her two older sons have both had episodes describes as testicular torsion, as well as vague abdominal symptoms and livedoid rashes. Their younger brother has been severely affected from a young age, despite the same genotype. He suffered a stroke and has been unable to stop anti-TNF therapy due to ongoing PAN-like vasculitis, vasculopathy and fever. Imaging of the adult family members has revealed no evidence of silent infarction or haemorrhage within the brain. There is borderline low IgM in all homozygous cases. The heterozygous father has no symptoms and no abnormal laboratory or imaging findings, however, his ADA2 level is lower than wild-type healthy controls.

Cerebral and visceral angiography was normal in all cases with no aneurysm formation or occlusive stenotic lesions. This contrasts with the G47V phenotype reported in which vascular manifestations appear to predominate[276].

The absence of a significant disease phenotype in the homozygous mother and homozygous siblings poses a significant clinical dilemma. The imaging and laboratory findings are reassuring but we know there is a stroke phenotype associated with the homozygous state. As the symptomatic index case has the same parents and has grown up in the same environment as the other siblings, suggesting there may be other genetic or epigenetic factors responsible for the disease phenotype – the wide spectrum of disease phenotype described in this condition certainly suggests that is possible. It is not certain how to predict “at risk” periods for stroke and whether stroke can be prevented by immunosuppression or by controlling classical risk factors. In keeping with verbal communication of unpublished data from the NIH our index case has had no further neurological events on anti-TNF therapy. To date the mother and the adult siblings have not been treated with anti-TNF therapy and it is unlikely that funding would be available for this in the UK in any case.

## **International Delphi survey for the classification of the diagnosis, management and follow-up of those with suspected DADA2 and their relatives**

### **Introduction**

DADA2 was first described in 2014 and by early 2017 over 80 cases had been described in the literature. The broad clinical phenotype even between homozygotes with the same mutation from the same family was described earlier in this chapter.

In 2016 the DADA2 Foundation, a charity established in the U.S by a former surgeon whose family have the disease, invited clinicians and scientists to the USA from all over the world to present their cases and discuss their theories of pathogenicity (<http://www.dada2.org/conference>). The abstracts submitted to this meeting depicted broad clinical heterogeneity and mounting anecdotal evidence for the use of anti-TNF, a treatment strategy that has been hitherto largely unsuccessful in the other vasculitides [294].

With increasing recognition of this disease and increased availability of genetic testing there was a clear need to define disease and carrier status, and to develop consensus regarding diagnosis, investigation and management of those with this disease and their family members.

### **Methods**

The Delphi technique is a consensus building methodology designed to combine judgments from a group of experts[295]. The Delphi Technique involves a series of well-defined questionnaire-based surveys each of which is based on the results of the previous step. The process stops when consensus of at least 80% of the participants on each item is reached[296].

Using the online survey platform Survey Monkey®, the first round was created by TY and tested by HJL. It consisted of 44 fictional clinical case-based questions. The survey was sent to all attendees of the Inaugural DADA2 Foundation symposium via the DADA2 Foundation charity

(<http://www.dada2.org>) and the corresponding authors of all published manuscripts on DADA2. Three reminder emails were sent. After three months Round 1 was closed. The responses were analysed to generate a further series of statements employed as the basis for Round 2 and sent to those who had responded in Round 1.

Round 2 consisted of 17 questions and was designed to bring consensus in 4 key areas: (i) Diagnosis, (ii) Investigation and Management, (iii) Follow-up Investigation and Management (iv) Screening of relatives. An invitation to participate was then sent out to all the previous study participants.

## Results

The survey generated > 4,000 data points and many pages of free text written by international experts. The results and discussion in this chapter will focus on the main areas of accord and discord.

Round 1 was sent in February 2017. There were 69 participants. 76% paediatricians 20% adult physicians; rheumatologists, nurse practitioners, haematologists, nephrologists, immunologists, geneticist, and clinical lab geneticists.

Round 2 was sent out to participants from Round 1 in November 2017. There were 17 questions in total. 53 people participated.

## Participants

**Figure: 7.7: Responses to Question: How many cases of confirmed DADA2 cases have you previously managed?**

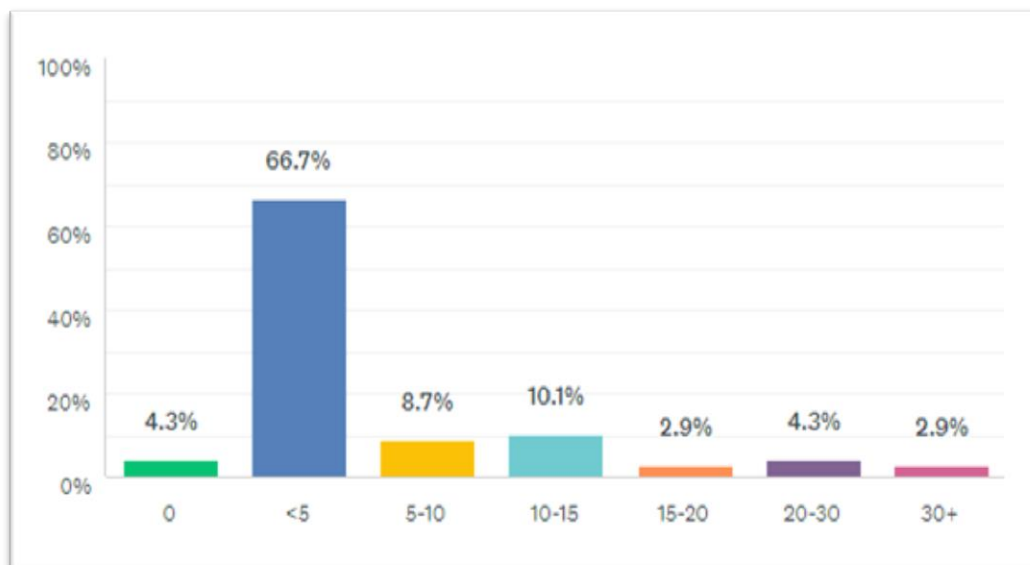

In keeping with the current rarity of the disease most participants had managed < 5 cases of DADA2. A few participants were non-clinical thus had not personally managed cases.



**Figure 7.8: Do you routinely refer to a geneticist for genetic counselling at your centre?**

ANSWER CHOICES	RESPONSES	
Yes	39.1%	27
No	13.0%	9
Genetic counselling is performed by the clinicians informally during the consultation	26.1%	18
It is available if the patient/relative wishes	7.2%	5
There are trained genetic counselors in clinic	5.8%	4
Other (please specify)	8.7%	6
TOTAL		69

Figure shows a wide variety in practice regarding genetic counselling in this condition. However, 62.9% are performing genetic counselling either by referral or during clinic.

**Figure 7.9: Responses to Question: Are you able to perform the gene sequencing at your centre?**

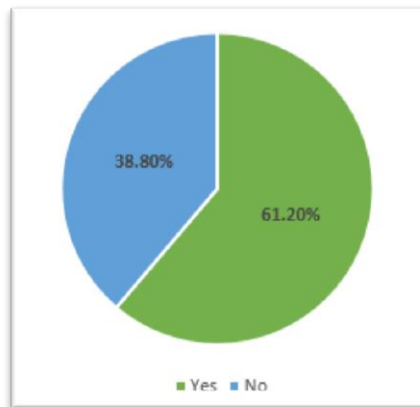

Figure shows that 61.2% of study participants can perform gene sequencing in the centre in which they work.

**Figure 7.10: Responses to Question: Are you able to measure ADA2 activity levels?**

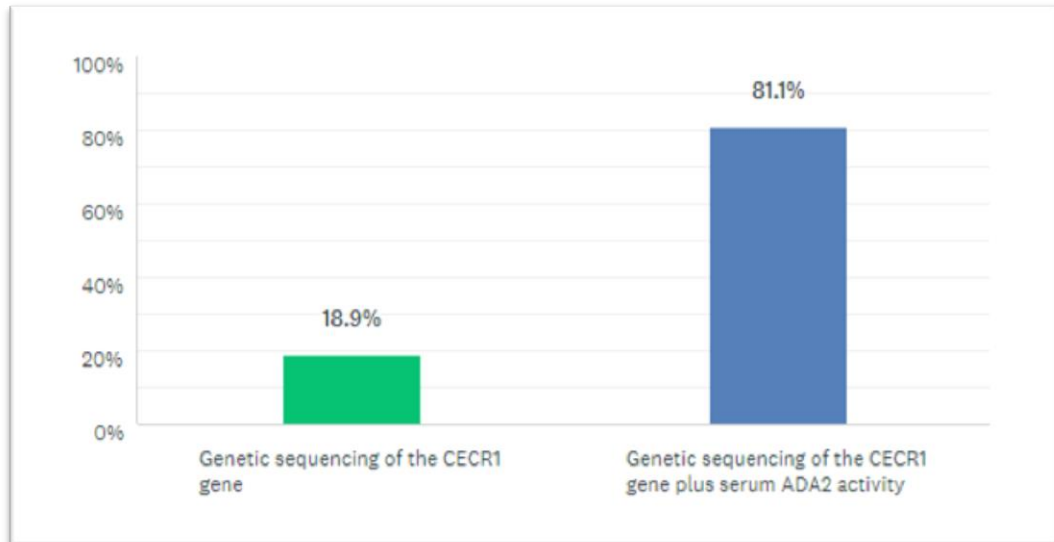
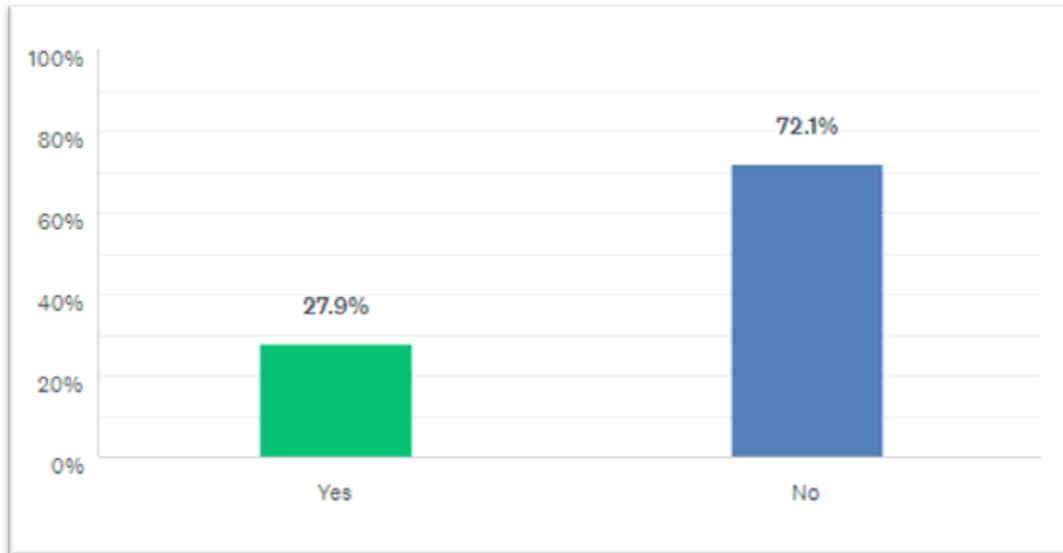

Figure shows that 72% of study participants are unable to measure ADA2 enzyme activity levels in their own centre.

## Theme 1: Diagnosis

**Figure 7.11: Responses to Question: What do you consider to be the gold standard diagnostic test/(s) for DADA2?**



Figures shows that there is consensus on the gold standard diagnostic test which is genetic test and enzyme activity. 61% can perform their own gene sequencing but only 18.9% are able to measure enzyme activity in their own centre.

**Figure 7.12: Responses to Question: What do you consider to be a positive test for DADA2 in a symptomatic patient?**

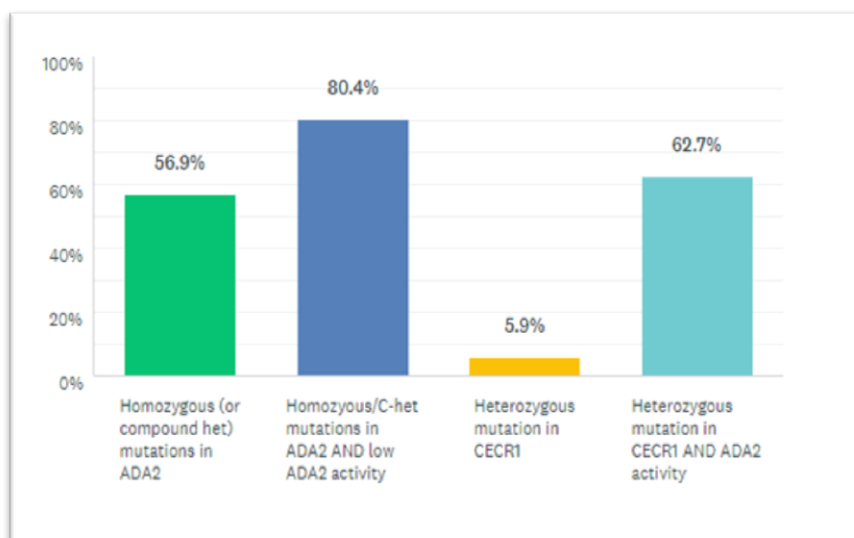

There is consensus that homozygous or compound heterozygous mutations and low ADA2 activity in a symptomatic patient is diagnostic of DADA2. 56.9% do not think the enzyme activity is necessary with homozygous mutations and symptoms. 62.7% consider a true heterozygous with low activity and symptoms to be diagnostic.

**Figure 7.13: Responses to Question: True heterozygotes can have DADA2?**

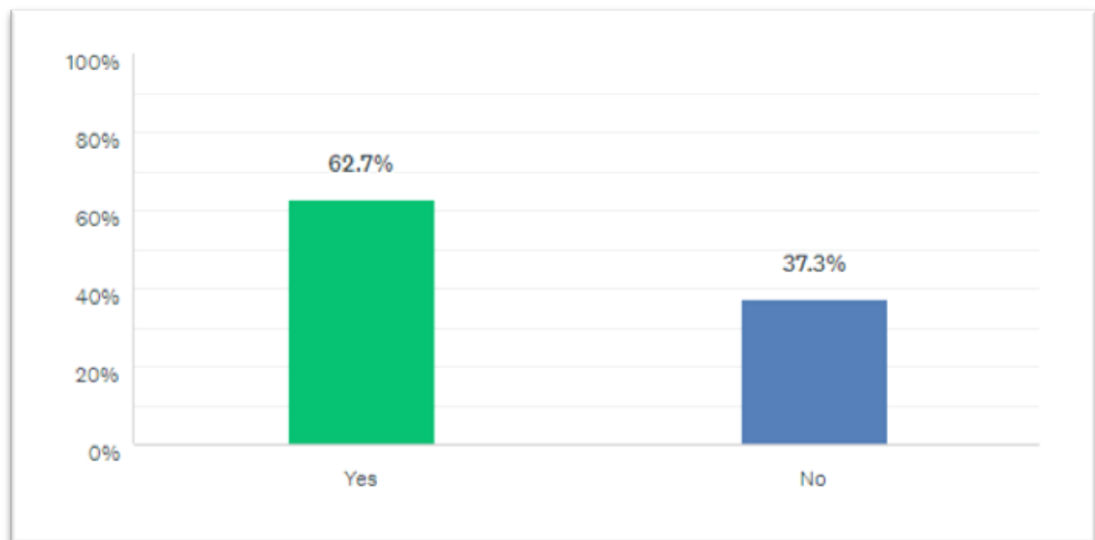

37.3% do not believe a true heterozygote can have DADA2. This is a controversial area. For the 62.7% who diagnose DADA2 in those with only a single gene mutation, most wrote free text to say they would need strong clinical evidence and low ADA2 levels. Disease in true heterozygotes suggests other genes may be involved in the phenotype, and/or environmental factors.

**Table 7.3: Responses to the Question: Which do you consider to be presenting symptoms/signs of DADA2?**

Presenting Symptoms and Signs (From published cases to February 2017)	Agreement (%)
Headache Non-specific	47.06
Headache Migraine	19.12
Non-specific abdominal pain	39.71
Livedoid rash	95.59
Digital gangrene	83.82
Fever	86.76
Peripheral neuropathy	52.94
Weight loss	42.65
Stroke	94.12
Post-prandial pain	16.18
Arthralgia	45.59
Rash - other	54.41
Arthritis	51.47
Ocular inflammation	27.94
Vomiting	19.12
Diarrhoea	17.65
Night sweats	16.18
Visual disturbance	45.59
Haematuria	20.59
Erythema nodosum	41.18
Symptomatic Anaemia	54.41
Failure to thrive	33.82
Raised serum creatinine	26.47
Active urinary sediment	19.12
Lymphadenopathy	38.24
Cytopenias	67.65
Splenomegaly	63.82
Hepatomegaly	58.82
Oral ulceration	27.94
Genital ulceration	14.71
Hypertension	50.00
Hearing loss	22.06
Hypogammaglobulinaemia	66.18
Low IgM	42.65
Low IgA	23.53

Respondents were asked to vote for the symptoms they considered to be suggestive of DADA2 based on the presenting features of all published cases to date of censor (February 2017). Green = > 80% = consensus, Orange = > 60% = moving towards consensus.

## Theme 2: Investigations

**Figure 7.14: Responses to Question: I measure the following at baseline diagnosis of DADA2**

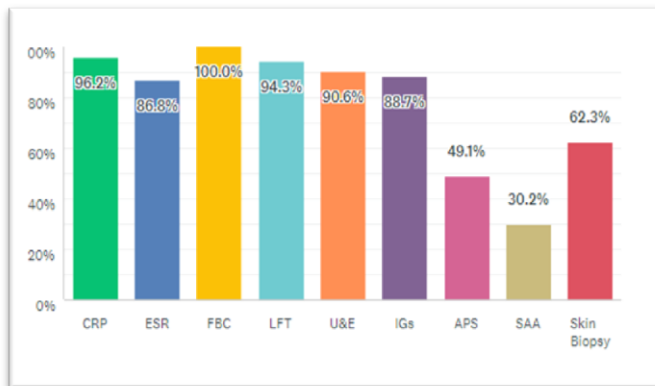

Figure shows there is consensus on the measurement of the acute phase response markers, baseline liver and renal function and immunoglobulins. SAA is only requested in a small proportion and yet AA amyloidosis has already been reported in these patients. Skin biopsy is requested by 62.3%.

**Figure 7.15: Responses to Question: I request the following investigations at baseline, irrespective of symptoms**

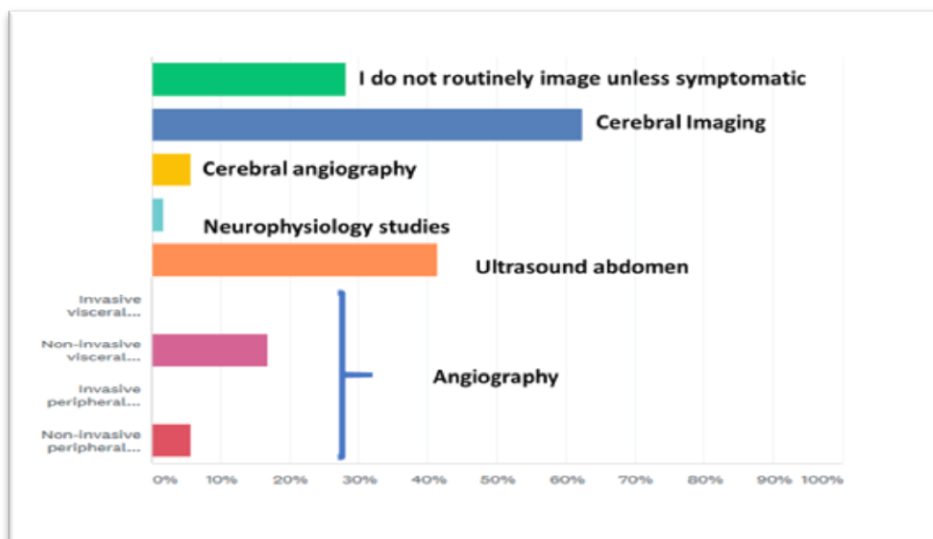
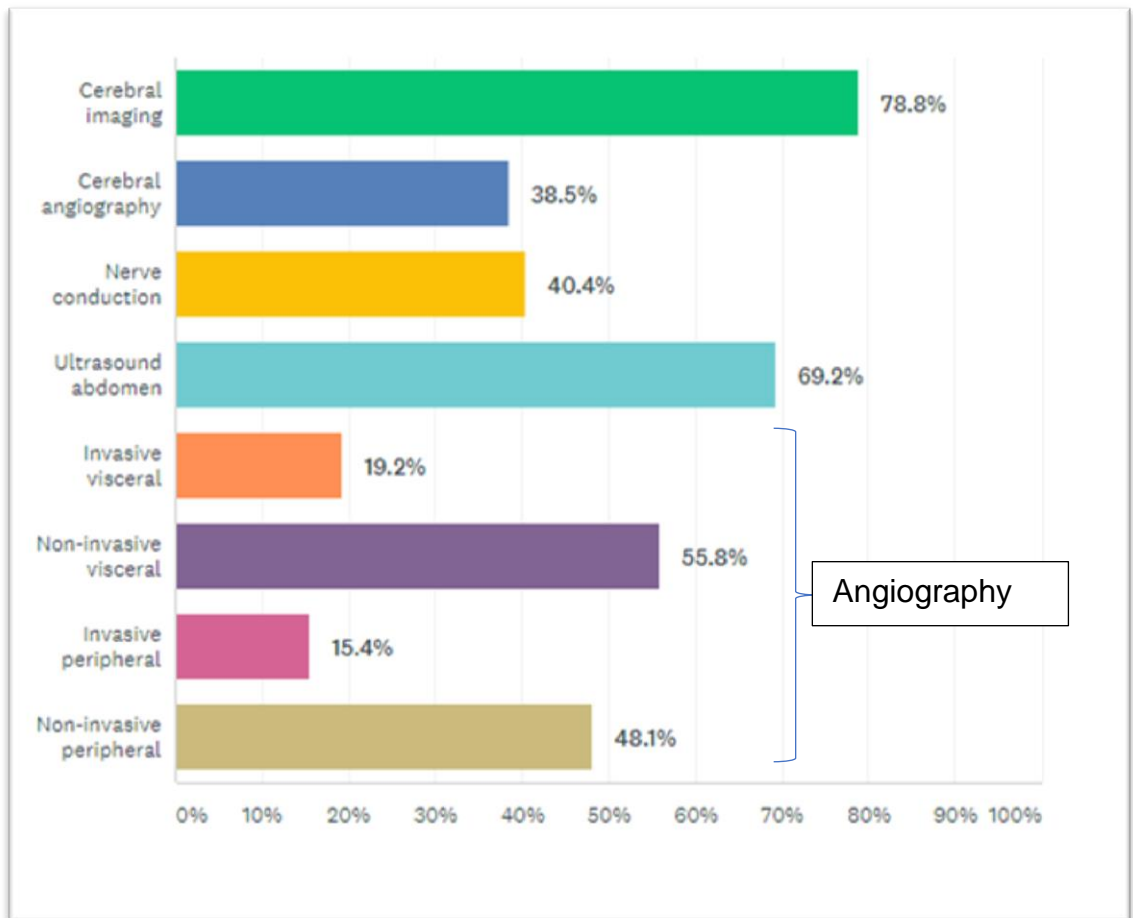

Figure shows that it was not possible to reach consensus on any imaging modality because 30% of study participants do not routinely image patients unless symptomatic in that organ system. 64% participants do request baseline cerebral imaging.

**Figure 7.16: Responses to Question: I request the following imaging investigations only if the patient is symptomatic in that organ system**



There is not yet consensus to image the brain in those with neurological symptoms. There is also no consensus on the use of angiography in these cases in contrast to that of PAN where it is standard.

**Figure 7.17: Responses to Question: What investigations do you use for follow-up of patients on treatment**

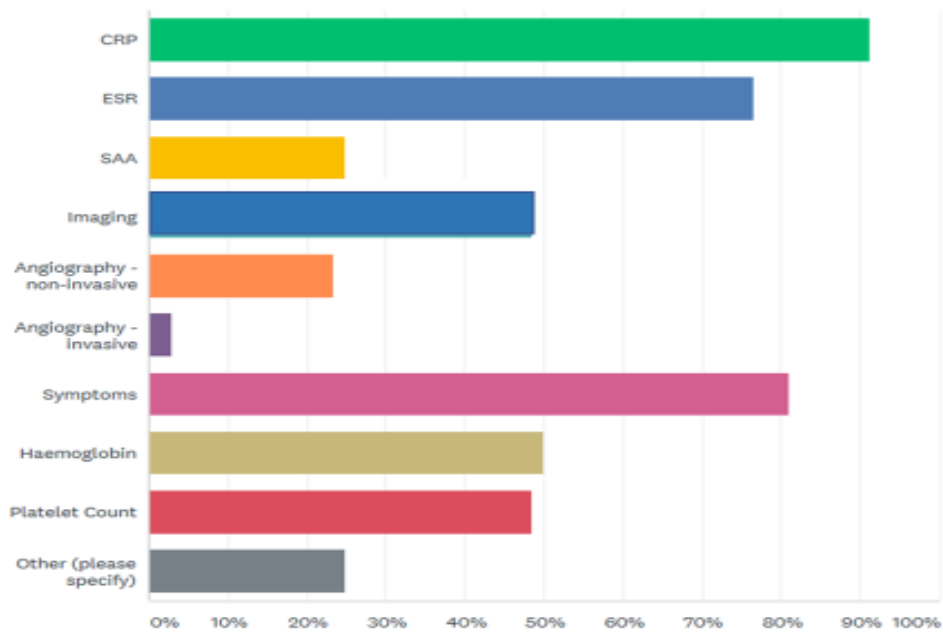

Figure identifies that CRP and symptoms are used by consensus majority to monitor follow-up.

**Figure 7.18: Responses to Question: What do you consider a raised CRP in DADA2?**

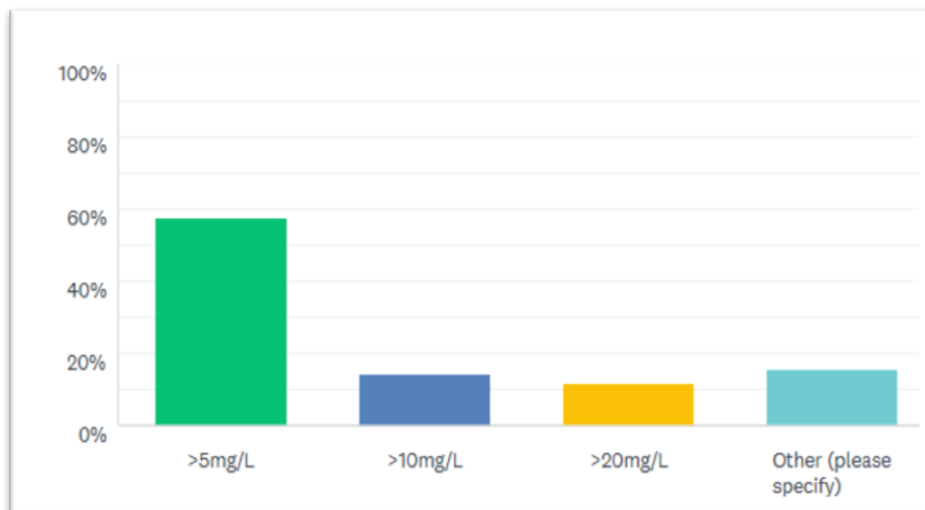

Figure shows that a CRP value of > 5mg/L has consensus agreement that this is elevated in DADA2.



**Figure 7.19: Responses to Question: In those with a confirmed diagnosis of DADA2 and established on treatment with normal CRP would you routinely use imaging if asymptomatic at follow-up?**

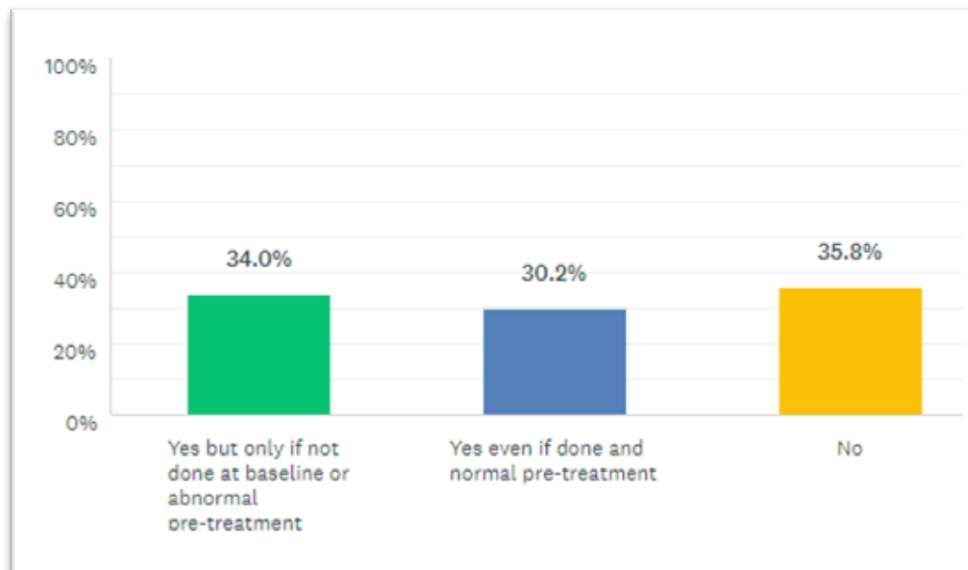

Figure shows no consensus agreement regarding investigations at follow-up. 35.8% would not perform any routine investigations and 34% would only request these if done at baseline.

### Theme 3: Treatment

**Figure 7.20: Responses to Question: In an acute event i.e. stroke in a proven case of DADA2 I would treat with the following**

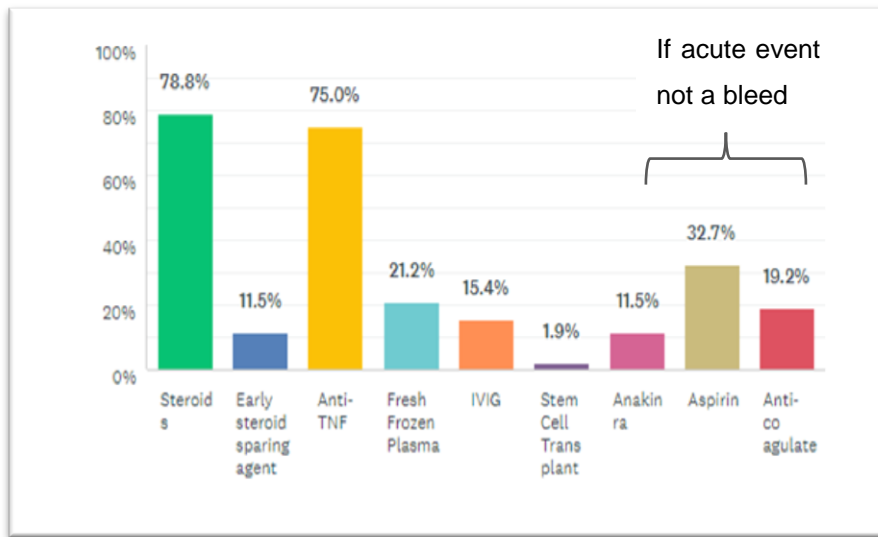

Figure shows that steroids and anti-TNF are suggested treatment in the majority in those with DADA2 and an acute event, however, neither reaches the 80% threshold for consensus.

**Figure 7.21: Responses to Question: For the treatment of DADA2 my first-line treatment is**

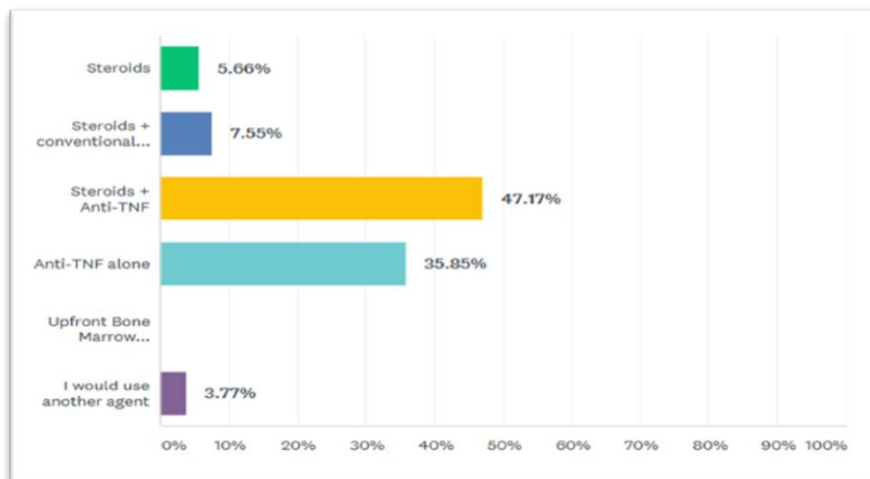

Figure shows that steroids and anti-TNF, or anti-TNF alone reach consensus for the use of anti-TNF in DADA2; 83.01%. Other agents suggested in free text were; mycophenolate mofetil, thalidomide, azathioprine, methotrexate and hydroxychloroquine.

**Figure 7.22: Responses to Question: If funding was no object my preferred long-term treatment in DADA2 would be:**

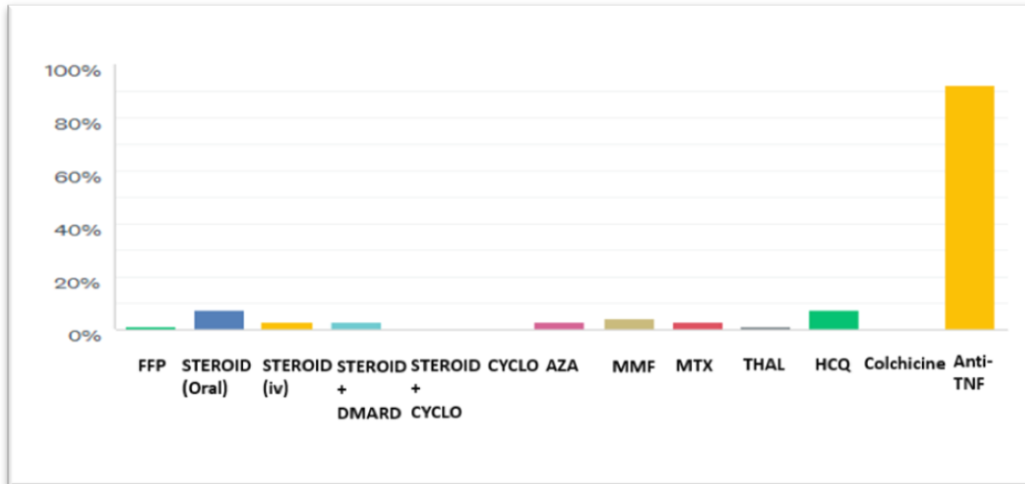

Figure shows there is a clear consensus (96%) that anti-TNF is the preferred long-term treatment for DADA2. Many study participants have difficulty accessing these high cost drugs.

**Figure 7.23: Responses to Question: Anti-TNF, if effective, should be given**

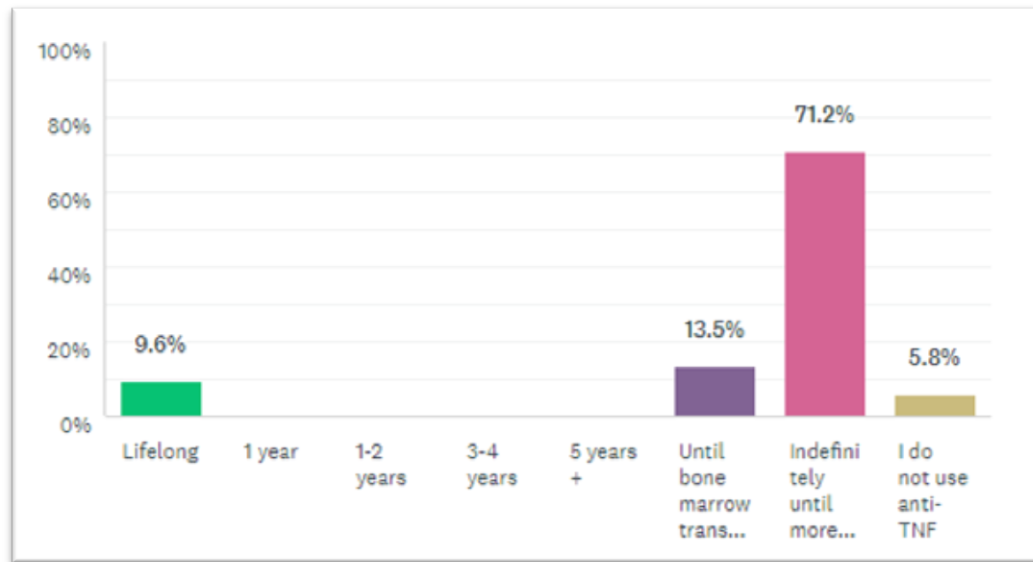
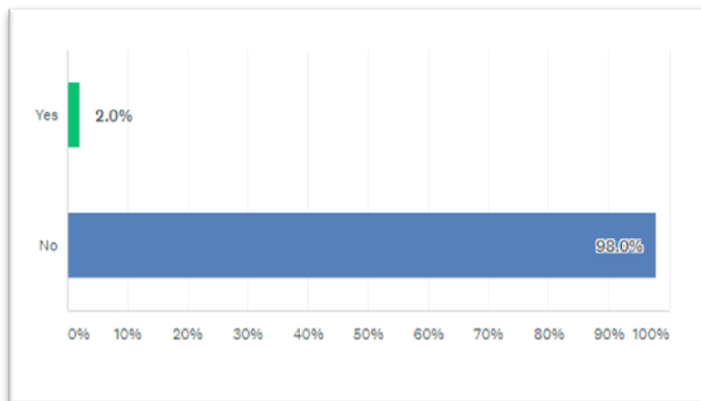

Figure shows that in those who use anti-TNF (consensus majority), there is further consensus that this should be either indefinitely until more information is available, lifelong or until bone marrow transplantation;  $71.2+9.6+13.5=94.4\%$ .

**Figure 7.24: Responses to Question: If no history of haemorrhage, such as haemorrhagic stroke, based on currently available evidence I routinely anti-coagulate my patients with DADA2**



Anti-coagulation is not recommended by consensus (98%). This is based on concerns that there can be vasculitic lesions in the brain that may be friable and bleed causing stroke in addition to the traditional risks posed by anti-coagulants.

**Figure 7.25: Responses to Question: If no history of haemorrhage, such as haemorrhagic stroke, based on currently available evidence I routinely give anti-platelet agents to my patients with DADA2**

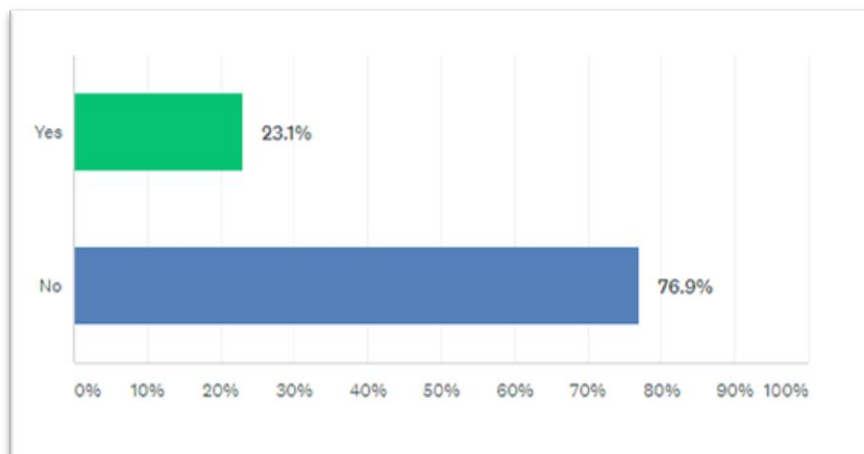

Consensus has not yet been reached on the use of anti-platelet agents in DADA2. Anti-platelet drugs are an important adjunct in stroke and digital ischaemia but there is concern regarding brain haemorrhage in those with DADA2.

## Theme 4: Screening of relatives

**Figure 7.26: Responses to Question: Genetic screening, please select only one choice that best reflects your current practice**

ANSWER CHOICES	RESPONSES
I don't request gene sequencing of the CECR1 gene on any relatives	1.9% 1
I only request gene sequencing on relatives that have suggestive symptoms	17.3% 9
I request sequencing on all siblings and parents	69.2% 36
I request sequencing only on symptomatic siblings and parents	11.5% 6

Figure shows percentage responses to the question of genetic screening in relatives of those with DADA2. There is not yet consensus on genetic screening of relatives, although only a single respondent didn't request gene sequencing on any relatives.

**Figure 7.27: Responses to Question: In asymptomatic relatives with a mutation/s in the CECR1 gene, in an ideal world I would**

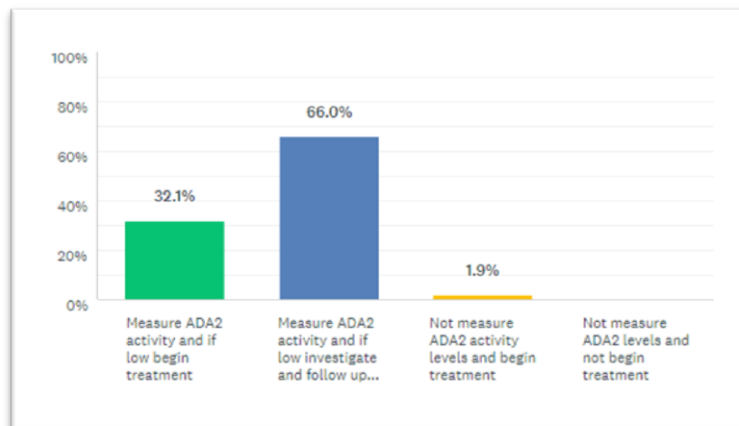

Figure shows percentage agreement on the investigation of asymptomatic relatives in whom mutations have been identified. There is no general consensus but agreement can be found if just the question of measurement of ADA2 activity levels is used:  $32.1+66=98.1$ .

**Figure 7.28: Responses to Question: Would you follow-up asymptomatic relatives with heterozygous mutations in CECR1?**

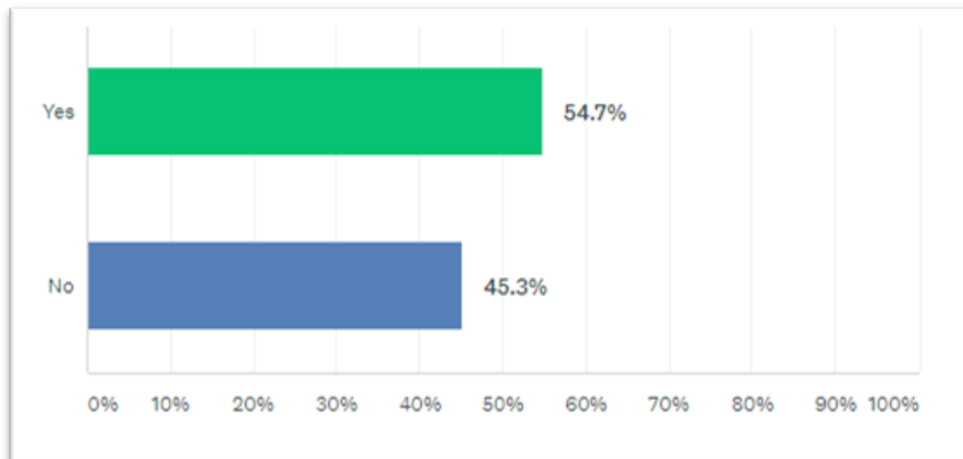

Figure shows large split in expert opinion as to whether asymptomatic heterozygotes should be under routine follow.

**Figure 7.29: Responses to Question: In which circumstances would you follow-up carriers of mutations in DADA2:**

ANSWER CHOICES	RESPONSES	
I do not follow up asymptomatic carriers	34.85%	23
I only follow up homozygotes	1.52%	1
I follow up all carriers	16.67%	11
I only follow up carriers if symptoms arise	19.70%	13
I only follow up carriers who have low ADA2 activity	13.64%	9
I only follow up carriers who have elevated CRP	0.00%	0
I only follow up carriers who have both elevated CRP and low ADA2 activity	4.55%	3
Other, please state:	9.09%	6

Figure showing that 34.85% do not follow-up any asymptomatic carriers. 56.65% will follow-up carriers.

## **Discussion**

At the time the first round of the Delphi was designed only 89 cases of DADA2 had been reported in the literature. The fact that there were 66 very eminent and knowledgeable respondents from all over the world was especially gratifying, representing one expert respondent to every 1.3 patient published. Since that time there has been an explosion of interest in this disease, and considerably more cases identified. Of note, the disease phenotype has evolved over this short period of time to include a haematological and immunodeficiency phenotype. Of particular interest to me, the diversity of phenotype suggests a broad physiological role of the ADA2 enzyme that requires further elucidation. In the past, monogenic diseases have proved to be a fertile area for research into specific genes, helping to elucidate their function and ultimately to develop treatment for the condition involved.

I presented the data from the Delphi study conducted at the start of the 2<sup>nd</sup> DADA2 congress in Bethesda, Maryland in November 2018 and the results prompted much discussion.

## **Diagnosis**

There is consensus that the gold standard diagnostic test for DADA2 is both a genetic test and an enzyme activity assay (81.1%). This poses a logistical problem as currently only 61% of centres can perform their own gene sequencing, while only 18.9% are able to measure enzyme activity in their own centre.

There is consensus that homozygous or compound heterozygous mutations and low ADA2 activity in a symptomatic patient is diagnostic of DADA2. However, despite 81.1% agreeing that a diagnostic gold standard is both the genetics and enzymatic activity, 56.9% do not think the enzyme activity is necessary for diagnosis in the presence of homozygous mutations and characteristic symptoms. It is too early to know whether those homozygotes with low ADA2 activity will always go on to develop a disease phenotype.

Consensus has been reached that livedoid rash, stroke, fever and digital gangrene are presenting symptoms of DADA2. Cytopenias, splenomegaly and hypogammaglobulinaemia had reached agreements of greater than 60%

and, given the expansion of interest in the haematological manifestations of this condition since the survey was conceived, it is likely that these figures would now reach higher levels of prominence in the diagnosis of DADA2.

### **Investigation**

There is consensus on the measurement of the acute phase response markers, baseline liver and renal function and immunoglobulins. SAA is only requested in a small proportion and yet AA amyloidosis has already been reported in these patients despite fairly low-grade inflammation in the literature[297]. This is likely to be an important observation and further research is required to understand pathogenesis and identify those patients most at risk. Skin biopsy is requested by 62.3%.

It was not possible to reach consensus on any imaging modality at baseline or follow-up because 30% of study participants do not routinely image patients unless symptomatic in that organ system. This may be due to local availability of imaging, as well as cost to the provider and the patient. Of note, 64% of respondents do request baseline cerebral imaging.

CRP and symptoms are used by consensus majority to monitor follow-up and the group have defined a CRP of greater than 5 mg/L as abnormal in DADA2.

### **Treatment**

There is overwhelming consensus that anti-TNF is the treatment of choice in the long-term management of this condition currently (96.1%). Corticosteroids and anti-TNF are suggested treatments in the majority in those with DADA2 and an acute event, such as a stroke, however, neither reaches the 80% threshold for consensus individually. IVIG and Fresh Frozen Plasma (FFP) may contain ADA2 and theoretically this may be therapeutic but no data exists, although several studies are underway and one was aborted due to the difficulty of administering enough FFP to raise ADA2 levels in the blood. Although there is no agreement for a role for mycophenolate mofetil, thalidomide, azathioprine, methotrexate and hydroxychloroquine in the treatment of DADA2, they do



appear to be in use by some and this perhaps reflects local funding restrictions on biologic therapies, and this was frequently described in the free text of the Delphi.

There is consensus that anti-TNF therapies should be used either indefinitely or until more information is available (94.4%). Autologous stem cell transplantation has been reported in 18 cases of DADA2 to date with mixed results[99]. Gene therapy is being investigated as it has been transformative in the treatment of ADA1[281]. The risk of anti-TNF resistance due to immunogenicity may prove to be a problem over the longer term for individual patients and will need to be given consideration.

There is consensus agreement that anti-coagulation should not be given (98%). This is based on concerns that there can be vasculitic lesions in the brain that may be friable and bleed causing stroke in addition to the traditional risks posed by anti-coagulants.

However, consensus has not yet been reached on the use of anti-platelet agents in DADA2. Anti-platelet drugs are an important adjunct in other forms of stroke and in digital ischaemia, although there is concern regarding the risk of brain haemorrhage in those with DADA2.

There was also consensus in the free text that statins should not be used unless indicated by raised serum lipids and that hypertension should be routinely screened for and treated with angiotensin converting enzyme inhibition in preference.

### **Screening of relatives**

There is not yet consensus agreement on the genetic screening of relatives, although only a single respondent does not request gene sequencing on any relatives. Genetic counselling is available to most respondents, either directly in their clinic, performed by them, or they can refer to a specialist service. This is important, not least given the risk of stroke in these patients that extends into adulthood and which may influence life choices and pose insurance difficulties when information regarding prognosis in this disease remains unclear. It also remains to be determined whether any treatment prevents stroke, however, I

am aware that unpublished data from one large group has shown not one single stroke occurring on anti-TNF treatment (verbal communication).

There is no general consensus on how to investigate asymptomatic relatives in whom mutations have been identified. Agreement can be reached if the answers regarding measurements of ADA2 activity levels are combined to suggest that there is consensus that if mutations are found in asymptomatic relatives, further investigation should be guided by ADA2 activity levels (98%). This fits with data from earlier in the study that shows that 62.7% consider a true heterozygote with low activity and symptoms to have a diagnosis of DADA2. Nevertheless, 34.85% do not follow-up any asymptomatic carriers. While 56.65% will follow-up carriers. Based on the data presented the following algorithm is proposed (Figure 7.30).

This work has generated the foundations for a larger consensus study on DADA2 beginning in April 2019. This will include patient reported outcome data to further inform our understanding of this condition and its treatment. Once diagnostic criteria and outcome data have been established, large scale clinical trials can be conducted. Large international studies are necessary in rare diseases, although it should be noted that ADA2 gene sequencing may be added to routine haematology genetics panels for the screening of those with bone marrow failure and pure red cell aplasia, and it may transpire that this disease is not as rare as previously considered.

There remains a pressing need for further work on the heterozygous state and for the carrier status defined, with mounting evidence that those with intermediate levels of ADA2 activity (mutation carriers) are susceptible to migraine, late-onset strokes and Raynaud phenomenon. This will be aided by an international collaborative prospective approach where cases are collated and subject to a standardised set of investigations and follow-up schedule. Cases of DADA2 are already being registered on EUROFEVERS (<https://www.printo.it/eurofever/index.asp>). Environmental data such as smoking status and risk factors for vasculitis such as hepatitis serology should be collected. Additionally, work could be directed into looking for somatic mosaicism of ADA2 in adult onset PAN.

The highly variable phenotype of DADA2 means that awareness of this condition needs to be raised across the medical specialities, both in paediatric and adult medicine, especially in light of the emerging evidence that anti-TNF therapy may augment stroke risk.

**Figure 7.30: Proposed algorithm for the investigation and management of those with suspected DADA2**

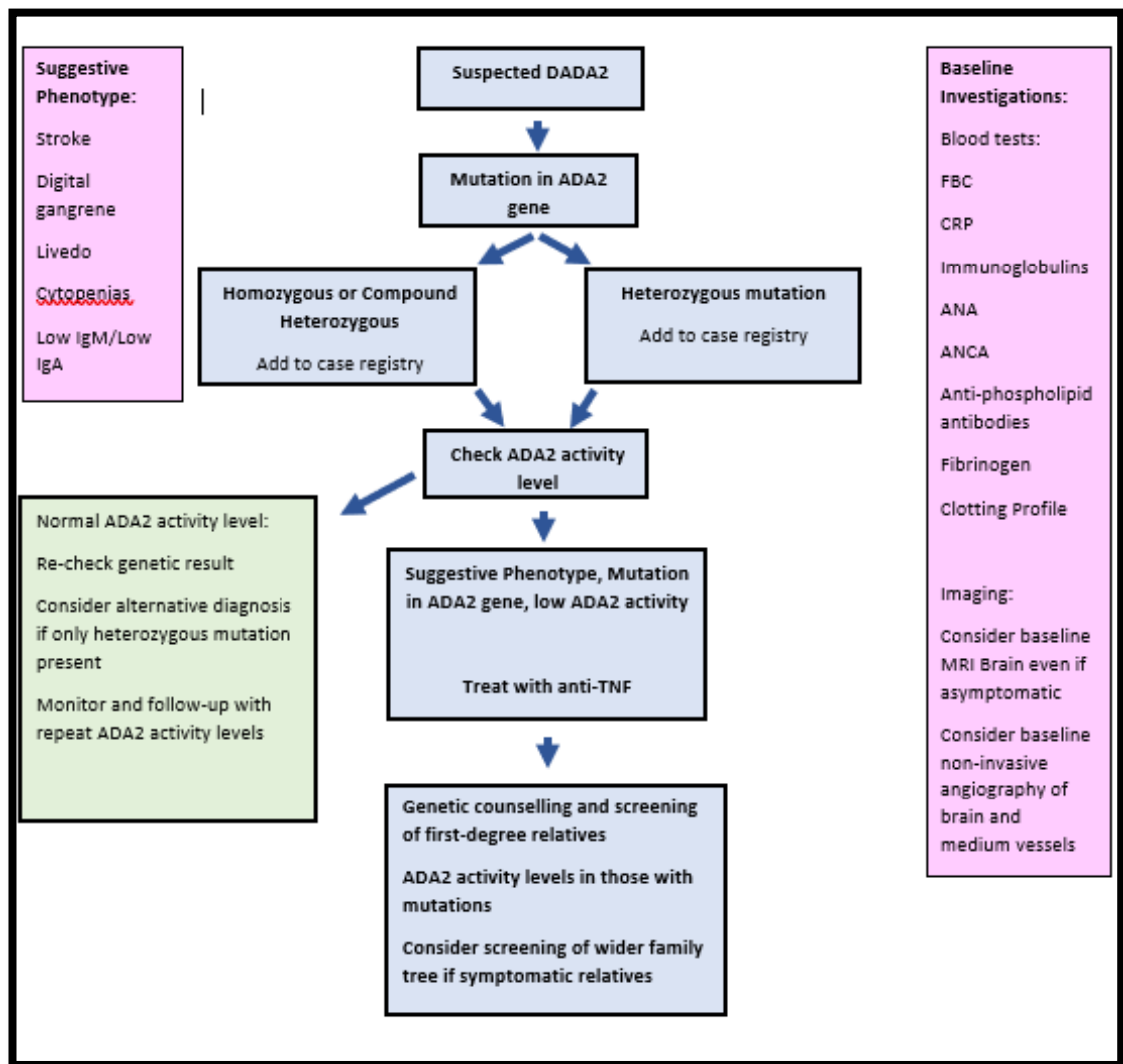

This figure depicts a proposed algorithm based on data from the study showing that those with a suggestive phenotype should undergo genetic screening and have their ADA2 enzyme activity level checked. In those with a confirmed diagnosis anti-TNF should be started. Genetic counselling should be offered, and genetic screening performed in all first-degree relatives with ADA2 levels checked in those with variants in the ADA2 gene.

**Chapter Eight:**  
**General Conclusions & Future Directions**

The fields of both amyloidosis and autoinflammatory diseases are rapidly evolving, largely due to improvements in genetic, laboratory and imaging diagnostics as well as tremendous leaps forward with biologic therapies over the past 20 years.

These advances have led to an apparent increase in the prevalence of systemic amyloidosis and SAIDs but it is likely many remain underdiagnosed and diagnostic delay remains the norm.

The work contained in this thesis has contributed to knowledge and understanding of the clinical phenotypes of systemic amyloidosis and associated autoinflammatory diseases, with the common theme that improving our understanding of their pathogenesis can lead to early diagnoses and improved outcomes. Rather than a long Discussion chapter at the end of this thesis, there are in depth discussion sections at the end of each chapter.

Investigation of ATTRwt deposition in non-cardiac tissues determined that musculoskeletal deposition is probably an early event and visceral deposition occurs late. Carpal tunnel biopsy could be developed in routine practice to diagnose ATTRwt early, although it remains to be established whether progression from soft tissue to cardiac tissue is inevitable. Understanding the early natural history of ATTRwt is particularly important given emerging data to suggest it is a major cause of diastolic heart failure and in light of newly licensed treatments for ATTR. The development of a longitudinal cohort may shed light on the natural history of this disease and is now underway (IRAS 181075: Prevalence of ATTR amyloid in the carpal tunnel).

Advances in therapeutics over two decades have revolutionised the outcomes of many diseases, especially those of inflammatory arthritis; in both adults and children. Thus, the aetiology of AA amyloidosis, always a result of chronic inflammation, has changed over time. Further investigation of this changing aetiology has led to the novel observation that obesity may be an important emerging cause of AA amyloidosis, which has the potential to pose a major public health threat. Future work to explore the role of obesity in chronic low-grade inflammation and subsequent AA amyloidosis should be directed to

establishing cohorts in bariatric clinics. Screening for SAA polymorphisms in these cohorts may identify at risk individuals.

The treatment of the monogenic autoinflammatory fever syndromes with long term IL-1 inhibition is now well established. Restoring normal life experience to these young adults has led to questions regarding the safety of these agents in pregnancy. The data in Chapter 6, gathered from expert centres across 7 countries, is the first study showing outcomes on the use of anakinra and canakinumab at conception in males and females, throughout pregnancy and during breast feeding. The data are reassuring, and it is now our practice not to cease the use of, particularly anakinra, in pregnancy. Although there is a higher than expected incidence of renal agenesis in anakinra exposed pregnancies, no scientific explanation exists as to how exogenous IL-1Ra, which only differs from endogenous by a single methionine residue, may have a deleterious effect on nephrogenesis. Further data on the use of IL-1 antagonists in pregnancy need to be gathered on international registries and work is underway to establish this via the EUROFEVERS registry (<https://www.printo.it/eurofever/index.asp>).

Lastly, it is increasingly recognised that immunodeficiency and autoinflammation are linked. Chapter 7 explored the phenotype of Deficiency of Adenosine Deaminase 2 (DADA2) to demonstrate that it clearly extends beyond the initial vasculitis and vasculopathy description. Further, the international consensus study carried out identified areas of clear consensus such as diagnosis and treatment, but areas of clear contention, most notably the possibility of a carrier state, remain. This work has led to planned future studies exploring the action of ADA2 on the endothelium and further consensus building work, with a small panel of international experts led by the DADA2 foundation, due to commence during the 10<sup>th</sup> International Congress of FMF and Autoinflammatory Diseases, in Genoa, Italy, in April 2019.

The findings in this thesis do not exclusively inform those working in highly specialised services. In fact, centres such as the NAC rely on the knowledge of a myriad of generalists in the community and smaller hospitals to identify these patients and refer them on for specialist input. For example, the results herein

identify carpal tunnel syndrome as an early presenting feature of TTR amyloidosis and suggest that a history of heart failure should be sought in those who present with this condition later in life. They also suggest that a carpal tunnel tissue biopsy can be taken at routine surgery to identify amyloid deposition in the carpal tunnel. The results also demonstrate that those presenting with haematuria and found to have bladder amyloid on cystoscopic biopsy may have concurrent cardiac TTR amyloidosis for which new treatments are available. Knowledge of this, and the availability of the non-invasive Tc-DPD scan, could change practice in urology and further highlights the importance of histopathology laboratories developing experience in diagnosing and typing amyloid deposits outside tertiary centres. Similarly, quantification of proteinuria in those who are overweight may identify more cases of AA amyloidosis associated with adiposity, presenting the opportunity to treat raised circulating SAA (by weight management or immunosuppression) and avoid end stage renal disease. This strategy could be developed in general practice, a multitude of medical clinics, and more specialised bariatric clinics. Further, the data on the use of IL-1 inhibitors at conception, in pregnancy, and breast feeding significantly adds to existing knowledge in this area and can be used to counsel patients by obstetricians and maternal medicine physicians alike. Whilst DADA2 is unlikely to be diagnosed in general practice, these cases will almost certainly present to general paediatric and adult rheumatology, dermatology and neurology clinics – thus highlighting the importance of raising awareness and defining diagnostic criteria and management pathways for those with rare disease.

## References

1. Pepys, M.B., *Amyloidosis*. Annu Rev Med, 2006. **57**: p. 223-41.
2. Sipe, J.D., et al., *Amyloid fibril proteins and amyloidosis: chemical identification and clinical classification International Society of Amyloidosis 2016 Nomenclature Guidelines*. Amyloid, 2016. **23**(4): p. 209-213.
3. Sawaya, M.R., et al., *Atomic structures of amyloid cross-beta spines reveal varied steric zippers*. Nature, 2007. **447**(7143): p. 453-7.
4. Jaroniec, C.P., et al., *High-resolution molecular structure of a peptide in an amyloid fibril determined by magic angle spinning NMR spectroscopy*. Proc Natl Acad Sci U S A, 2004. **101**(3): p. 711-6.
5. Puchtler, H., F. Sweat, and M. Levine, *On the binding of Congo red by amyloid*. J. Histochem. Cytochem., 1962. **10**: p. 355-364.
6. Pepys, M.B., et al., *Human serum amyloid P component is an invariant constituent of amyloid deposits and has a uniquely homogeneous glycostructure*. Proc Natl Acad Sci U S A, 1994. **91**(12): p. 5602-6.
7. Kisilevsky, R. and P. Fraser, *Proteoglycans and amyloid fibrillogenesis*. Ciba Found Symp, 1996. **199**: p. 58-67; discussion 68-72, 90-103.
8. Gertz, M.A., *Immunoglobulin light chain amyloidosis: 2018 Update on diagnosis, prognosis, and treatment*. Am J Hematol, 2018. **93**(9): p. 1169-1180.
9. Rowczenio, D., et al., *Analysis of the TTR gene in the investigation of amyloidosis: A 25-year single UK center experience*. Hum Mutat, 2019. **40**(1): p. 90-96.
10. Pinney, J.H., et al., *Senile systemic amyloidosis: clinical features at presentation and outcome*. J Am Heart Assoc, 2013. **2**(2): p. e000098.
11. Marcoux, J., et al., *A novel mechano-enzymatic cleavage mechanism underlies transthyretin amyloidogenesis*. EMBO Mol Med, 2015. **7**(10): p. 1337-49.
12. Gillmore, J.D., et al., *Amyloid load and clinical outcome in AA amyloidosis in relation to circulating concentration of serum amyloid A protein*. Lancet, 2001. **358**(9275): p. 24-9.
13. Rezk, T., et al., *Diagnosis, pathogenesis and outcome in leucocyte chemotactic factor 2 (ALECT2) amyloidosis*. Nephrol Dial Transplant, 2018. **33**(2): p. 241-247.
14. Kisilevsky, R., S. Raimondi, and V. Bellotti, *Historical and Current Concepts of Fibrillogenesis and In vivo Amyloidogenesis: Implications of Amyloid Tissue Targeting*. Front Mol Biosci, 2016. **3**: p. 17.
15. Johan, K., et al., *Acceleration of amyloid protein A amyloidosis by amyloid-like synthetic fibrils*. Proc Natl Acad Sci U S A, 1998. **95**(5): p. 2558-63.
16. Simons, J.P., et al., *Pathogenetic mechanisms of amyloid A amyloidosis*. Proc Natl Acad Sci U S A, 2013. **110**(40): p. 16115-20.
17. Merlini, G. and V. Bellotti, *Molecular mechanisms of amyloidosis*. N Engl J Med, 2003. **349**(6): p. 583-96.
18. Bodin, K., et al., *Antibodies to human serum amyloid P component eliminate visceral amyloid deposits*. Nature, 2010. **468**(7320): p. 93-7.



19. Kyle, R.A., et al., *Incidence of AL Amyloidosis in Olmsted County, Minnesota, 1990 through 2015*. Mayo Clin Proc, 2019.
20. Pinney, J.H., et al., *Systemic amyloidosis in England: an epidemiological study*. Br J Haematol, 2013. **161**(4): p. 525-32.
21. Wechalekar, A.D., J.D. Gillmore, and P.N. Hawkins, *Systemic amyloidosis*. Lancet, 2016. **387**(10038): p. 2641-2654.
22. Schmidt, H.H., et al., *Estimating the global prevalence of transthyretin familial amyloid polyneuropathy*. Muscle Nerve, 2018. **57**(5): p. 829-837.
23. Reilly, M.M., H. Staunton, and A.E. Harding, *Familial amyloid polyneuropathy (TTR ala 60) in north west Ireland: a clinical, genetic, and epidemiological study*. J Neurol Neurosurg Psychiatry, 1995. **59**(1): p. 45-9.
24. Quarta, C.C., et al., *The amyloidogenic V122I transthyretin variant in elderly black Americans*. N Engl J Med, 2015. **372**(1): p. 21-9.
25. Lachmann, H.J., et al., *Natural history and outcome in systemic AA amyloidosis*. N Engl J Med, 2007. **356**(23): p. 2361-71.
26. Westermark, P., et al., *Fibril in senile systemic amyloidosis is derived from normal transthyretin*. Proc Natl Acad Sci U S A, 1990. **87**(7): p. 2843-5.
27. Schönland, S.O., et al., *Immunohistochemistry in the classification of systemic forms of amyloidosis: a systematic investigation of 117 patients*. Blood, 2012. **119**(2): p. 488-493.
28. Quarta, C.C., et al., *Diagnostic sensitivity of abdominal fat aspiration in cardiac amyloidosis*. Eur Heart J, 2017. **38**(24): p. 1905-1908.
29. Gillmore, J.D., et al., *Guidelines on the diagnosis and investigation of AL amyloidosis*. Br J Haematol, 2015. **168**(2): p. 207-18.
30. Gilbertson, J.A., et al., *A comparison of immunohistochemistry and mass spectrometry for determining the amyloid fibril protein from formalin-fixed biopsy tissue*. J Clin Pathol, 2015. **68**(4): p. 314-7.
31. Rezk, T., et al., *The complementary role of histology and proteomics for diagnosis and typing of systemic amyloidosis*. J Pathol Clin Res, 2019.
32. Mariani, L.L., et al., *Genotype-phenotype correlation and course of transthyretin familial amyloid polyneuropathies in France*. Ann Neurol, 2015. **78**(6): p. 901-16.
33. Pepys, M.B., et al., *Binding of serum amyloid P-component (SAP) by amyloid fibrils*. Clinical and experimental immunology, 1979. **38**(2): p. 284-293.
34. Hawkins, P.N., J.P. Lavender, and M.B. Pepys, *Evaluation of Systemic Amyloidosis by Scintigraphy with 123I-Labeled Serum Amyloid P Component*. New England Journal of Medicine, 1990. **323**(8): p. 508-513.
35. Wizenberg, T.A., et al., *Value of positive myocardial technetium-99m-pyrophosphate scintigraphy in the noninvasive diagnosis of cardiac amyloidosis*. Am Heart J, 1982. **103**(4 Pt 1): p. 468-73.
36. Falk, R.H., et al., *Sensitivity of technetium-99m-pyrophosphate scintigraphy in diagnosing cardiac amyloidosis*. The American Journal of Cardiology, 1983. **51**(5): p. 826-830.
37. Perugini, E., et al., *Noninvasive etiologic diagnosis of cardiac amyloidosis using 99mTc-3,3-diphosphono-1,2-propanodicarboxylic acid scintigraphy*. J Am Coll Cardiol, 2005. **46**(6): p. 1076-84.

38. Rapezzi, C., et al., *Usefulness and limitations of 99mTc-3,3-diphosphono-1,2-propanodicarboxylic acid scintigraphy in the aetiological diagnosis of amyloidotic cardiomyopathy*. European Journal of Nuclear Medicine and Molecular Imaging, 2011. **38**(3): p. 470-478.
39. Hutt, D.F., et al., *Prognostic utility of the Perugini grading of 99mTc-DPD scintigraphy in transthyretin (ATTR) amyloidosis and its relationship with skeletal muscle and soft tissue amyloid*. Eur Heart J Cardiovasc Imaging, 2017.
40. Gillmore, J.D., et al., *Nonbiopsy Diagnosis of Cardiac Transthyretin Amyloidosis*. Circulation, 2016. **133**(24): p. 2404-12.
41. Maceira, A.M., et al., *Cardiovascular magnetic resonance in cardiac amyloidosis*. Circulation, 2005. **111**(2): p. 186-93.
42. Fontana, M., et al., *Prognostic Value of Late Gadolinium Enhancement Cardiovascular Magnetic Resonance in Cardiac Amyloidosis*. Circulation, 2015. **132**(16): p. 1570-1579.
43. Dungu, J.N., et al., *CMR-based differentiation of AL and ATTR cardiac amyloidosis*. JACC Cardiovasc Imaging, 2014. **7**(2): p. 133-42.
44. Martinez-Naharro, A., et al., *Native T1 and Extracellular Volume in Transthyretin Amyloidosis*. JACC Cardiovasc Imaging, 2018.
45. Fontana, M., A. Martinez-Naharro, and P.N. Hawkins, *Staging Cardiac Amyloidosis With CMR: Understanding the Different Phenotypes*. JACC Cardiovasc Imaging, 2016. **9**(11): p. 1278-1279.
46. Gulani, V., et al., *Gadolinium deposition in the brain: summary of evidence and recommendations*. The Lancet Neurology, 2017. **16**(7): p. 564-570.
47. Martinez-Naharro, A., et al., *CMR-Verified Regression of Cardiac AL Amyloid After Chemotherapy*. JACC: Cardiovascular Imaging, 2018. **11**(1): p. 152-154.
48. Falk, R.H. and C.C. Quarta, *Echocardiography in cardiac amyloidosis*. Heart Failure Reviews, 2015. **20**(2): p. 125-131.
49. Dinwoodey, D.L., et al., *Light-Chain Amyloidosis With Echocardiographic Features of Hypertrophic Cardiomyopathy*. The American Journal of Cardiology, 2008. **101**(5): p. 674-676.
50. Pasternak, S., et al., *Monoclonal origin of localised orbital amyloidosis detected by molecular analysis*. Br J Ophthalmol, 1996. **80**(11): p. 1013-7.
51. Mahmood, S., et al., *Natural history and outcomes in localised immunoglobulin light-chain amyloidosis: a long-term observational study*. Lancet Haematol, 2015. **2**(6): p. e241-50.
52. Shah, P.L., et al., *The importance of complete screening for amyloid fibril type and systemic disease in patients with amyloidosis in the respiratory tract*. Sarcoidosis Vasc Diffuse Lung Dis, 2002. **19**(2): p. 134-42.
53. Shikama, Y., et al., *Localized amyloidosis at the site of repeated insulin injection in a diabetic patient*. Intern Med, 2010. **49**(5): p. 397-401.
54. Nasr, S.H., R. Colvin, and G.S. Markowitz, *IgG1 lambda light and heavy chain renal amyloidosis*. Kidney Int, 2006. **70**(1): p. 7.
55. Kourelis, T.V., et al., *Coexistent multiple myeloma or increased bone marrow plasma cells define equally high-risk populations in patients with immunoglobulin light chain amyloidosis*. Journal of clinical oncology :

- official journal of the American Society of Clinical Oncology, 2013. **31**(34): p. 4319-4324.
56. Rezk, T., et al., *Prolonged renal survival in light chain amyloidosis: speed and magnitude of light chain reduction is the crucial factor*. *Kidney Int*, 2017. **92**(6): p. 1476-1483.
  57. Merlini, G., *AL amyloidosis: from molecular mechanisms to targeted therapies*. Hematology. American Society of Hematology. Education Program, 2017. **2017**(1): p. 1-12.
  58. Dispenzieri, A., et al., *Serum cardiac troponins and N-terminal pro-brain natriuretic peptide: a staging system for primary systemic amyloidosis*. *J Clin Oncol*, 2004. **22**(18): p. 3751-7.
  59. Mahmood, S., et al., *Update on treatment of light chain amyloidosis*. *Haematologica*, 2014. **99**(2): p. 209-221.
  60. Manwani, R., et al., *Deferred autologous stem cell transplantation in systemic AL amyloidosis*. *Blood cancer journal*, 2018. **8**(11): p. 101-101.
  61. Manwani, R., et al., *Rapid hematologic responses improve outcomes in patients with very advanced (stage IIIb) cardiac immunoglobulin light chain amyloidosis*. *Haematologica*, 2018. **103**(4): p. e165-e168.
  62. Hawkins, P.N., et al., *Evolving landscape in the management of transthyretin amyloidosis*. *Ann Med*, 2015. **47**(8): p. 625-38.
  63. Maurer, M.S., et al., *Tafamidis Treatment for Patients with Transthyretin Amyloid Cardiomyopathy*. *N Engl J Med*, 2018. **379**(11): p. 1007-1016.
  64. Benson, M.D., et al., *Inotersen Treatment for Patients with Hereditary Transthyretin Amyloidosis*. *N Engl J Med*, 2018. **379**(1): p. 22-31.
  65. Adams, D., et al., *Patisiran, an RNAi Therapeutic, for Hereditary Transthyretin Amyloidosis*. *N Engl J Med*, 2018. **379**(1): p. 11-21.
  66. Gejyo, F., et al., *A new form of amyloid protein associated with chronic hemodialysis was identified as beta 2-microglobulin*. *Biochem Biophys Res Commun*, 1985. **129**(3): p. 701-6.
  67. Scarpioni, R., et al., *Dialysis-related amyloidosis: challenges and solutions*. *Int J Nephrol Renovasc Dis*, 2016. **9**: p. 319-328.
  68. Valleix, S., et al., *Hereditary systemic amyloidosis due to Asp76Asn variant beta2-microglobulin*. *N Engl J Med*, 2012. **366**(24): p. 2276-83.
  69. Sorci-Thomas, M.G. and M.J. Thomas, *The effects of altered apolipoprotein A-I structure on plasma HDL concentration*. *Trends Cardiovasc Med*, 2002. **12**(3): p. 121-8.
  70. Mucchiano, G.I., et al., *Apolipoprotein A-1-derived amyloid in atherosclerotic plaques of the human aorta*. *J Pathol*, 2001. **193**(2): p. 270-5.
  71. Solomon, A., et al., *Amyloid contained in the knee joint meniscus is formed from apolipoprotein A-I*. *Arthritis Rheum*, 2006. **54**(11): p. 3545-50.
  72. Lu, C., et al., *Apolipoprotein A-1-related amyloidosis 2 case reports and review of the literature*. *Medicine (Baltimore)*, 2017. **96**(39): p. e8148.
  73. Gillmore, J.D., et al., *Organ transplantation in hereditary apolipoprotein A1 amyloidosis*. *Am J Transplant*, 2006. **6**(10): p. 2342-7.
  74. Prokaeva, T., et al., *Hereditary Renal Amyloidosis Associated With a Novel Apolipoprotein A-II Variant*. *Kidney Int Rep*, 2017. **2**(6): p. 1223-1232.

75. Larsen, C.P., et al., *Clinical, morphologic, and genetic features of renal leukocyte chemotactic factor 2 amyloidosis*. *Kidney Int*, 2014. **86**(2): p. 378-82.
76. Benson, M.D., et al., *Leukocyte chemotactic factor 2: A novel renal amyloid protein*. *Kidney Int*, 2008. **74**(2): p. 218-22.
77. Larsen, C.P., et al., *Prevalence and morphology of leukocyte chemotactic factor 2-associated amyloid in renal biopsies*. *Kidney Int*, 2010. **77**(9): p. 816-9.
78. Nasr, S.H., A. Dogan, and C.P. Larsen, *Leukocyte Cell-Derived Chemotaxin 2-Associated Amyloidosis: A Recently Recognized Disease with Distinct Clinicopathologic Characteristics*. *Clin J Am Soc Nephrol*, 2015. **10**(11): p. 2084-93.
79. Gillmore, J.D., et al., *Diagnosis, pathogenesis, treatment, and prognosis of hereditary fibrinogen A alpha-chain amyloidosis*. *J Am Soc Nephrol*, 2009. **20**(2): p. 444-51.
80. Benson, M.D., et al., *Hereditary renal amyloidosis associated with a mutant fibrinogen alpha-chain*. *Nat Genet*, 1993. **3**(3): p. 252-5.
81. Stangou, A.J., et al., *Hereditary fibrinogen A alpha-chain amyloidosis: phenotypic characterization of a systemic disease and the role of liver transplantation*. *Blood*, 2010. **115**(15): p. 2998-3007.
82. de Souza, P.V.S., et al., *Familial progressive bilateral facial paralysis in Finnish type hereditary amyloidosis*. *Pract Neurol*, 2017. **17**(5): p. 408-409.
83. Meretoja, J., *Familial systemic paramyloidosis with lattice dystrophy of the cornea, progressive cranial neuropathy, skin changes and various internal symptoms. A previously unrecognized heritable syndrome*. *Ann Clin Res*, 1969. **1**(4): p. 314-24.
84. Kiuru, S., *Gelsolin-related familial amyloidosis, Finnish type (FAF), and its variants found worldwide*. *Amyloid*, 1998. **5**(1): p. 55-66.
85. Solomon, J.P., et al., *Gelsolin amyloidosis: genetics, biochemistry, pathology and possible strategies for therapeutic intervention*. *Crit Rev Biochem Mol Biol*, 2012. **47**(3): p. 282-96.
86. Pepys, M.B., et al., *Human lysozyme gene mutations cause hereditary systemic amyloidosis*. *Nature*, 1993. **362**(6420): p. 553-557.
87. Pleyer, C., J. Flesche, and F. Saeed, *Lysozyme amyloidosis - a case report and review of the literature*. *Clinical nephrology. Case studies*, 2015. **3**: p. 42-45.
88. Sattianayagam, P.T., et al., *Hereditary lysozyme amyloidosis -- phenotypic heterogeneity and the role of solid organ transplantation*. *J Intern Med*, 2012. **272**(1): p. 36-44.
89. Jayaraman, S., et al., *Serum amyloid A forms stable oligomers that disrupt vesicles at lysosomal pH and contribute to the pathogenesis of reactive amyloidosis*. *Proc Natl Acad Sci U S A*, 2017. **114**(32): p. E6507-E6515.
90. Sun, L. and R.D. Ye, *Serum amyloid A1: Structure, function and gene polymorphism*. *Gene*, 2016. **583**(1): p. 48-57.
91. Lane, T., et al., *Changing epidemiology of AA amyloidosis: clinical observations over 25 years at a single national referral centre*. *Amyloid*, 2017. **24**(3): p. 162-166.

92. Lane, T., et al., *Safety and efficacy of empirical interleukin-1 inhibition using anakinra in AA amyloidosis of uncertain aetiology*. *Amyloid*, 2017. **24**(3): p. 189-193.
93. Lane, T., et al., *Therapeutic blockade of interleukin-6 by tocilizumab in the management of AA amyloidosis and chronic inflammatory disorders: a case series and review of the literature*. *Clin Exp Rheumatol*, 2015. **33**(6 Suppl 94): p. S46-53.
94. Pepys, M.B., et al., *Targeted pharmacological depletion of serum amyloid P component for treatment of human amyloidosis*. *Nature*, 2002. **417**(6886): p. 254-9.
95. Richards, D.B., et al., *Therapeutic Clearance of Amyloid by Antibodies to Serum Amyloid P Component*. *New England Journal of Medicine*, 2015. **373**(12): p. 1106-1114.
96. Lane, T., et al., *AA amyloidosis complicating the hereditary periodic fever syndromes*. *Arthritis Rheum*, 2013. **65**(4): p. 1116-21.
97. Jesus, A.A. and R. Goldbach-Mansky, *IL-1 blockade in autoinflammatory syndromes*. *Annual review of medicine*, 2014. **65**: p. 223-244.
98. McGonagle, D., et al., *An integrated classification of pediatric inflammatory diseases, based on the concepts of autoinflammation and the immunological disease continuum*. *Pediatr Res*, 2009. **65**(5 Pt 2): p. 38r-45r.
99. Michniacki, T.F., et al., *Hematologic Manifestations of Deficiency of Adenosine Deaminase 2 (DADA2) and Response to Tumor Necrosis Factor Inhibition in DADA2-Associated Bone Marrow Failure*. *J Clin Immunol*, 2018. **38**(2): p. 166-173.
100. Rowczenio, D., et al., *210 Retrospective Analysis of Adult Referrals to the Periodic Fever Service at the National Amyloidosis Centre: Increasing Recognition of Adult-Onset Genetic Autoinflammatory Disease*. *Rheumatology*, 2016. **55**(suppl\_1): p. i147-i147.
101. Hawkins, P.N., H.J. Lachmann, and M.F. McDermott, *Interleukin-1-receptor antagonist in the Muckle-Wells syndrome*. *N Engl J Med*, 2003. **348**(25): p. 2583-4.
102. De Benedetti, F., et al., *Canakinumab for the Treatment of Autoinflammatory Recurrent Fever Syndromes*. *New England Journal of Medicine*, 2018. **378**(20): p. 1908-1919.
103. *Infevers, An online database for autoinflammatory mutations. International Society of Systemic Auto-Inflammatory Diseases*. Infevers Website Chief Editor Isabelle Touitou, 2019.
104. Lachmann, H.J., *Periodic fever syndromes*. *Best Pract Res Clin Rheumatol*, 2017. **31**(4): p. 596-609.
105. Martinon, F., et al., *Identification of bacterial muramyl dipeptide as activator of the NALP3/cryopyrin inflammasome*. *Curr Biol*, 2004. **14**(21): p. 1929-34.
106. Martinon, F., et al., *Gout-associated uric acid crystals activate the NALP3 inflammasome*. *Nature*, 2006. **440**(7081): p. 237-41.
107. Martinon, F., K. Burns, and J. Tschopp, *The inflammasome: a molecular platform triggering activation of inflammatory caspases and processing of proIL-beta*. *Mol Cell*, 2002. **10**(2): p. 417-26.
108. Dinarello, C.A., *Interleukin-1 in the pathogenesis and treatment of inflammatory diseases*. *Blood*, 2011. **117**(14): p. 3720-32.

109. Finch, D. and M. Sleeman, *Finding a place for interleukin-1 inhibitors in the treatment of rheumatologic diseases*. *Curr Pharm Des*, 2015. **21**(17): p. 2198-205.
110. Fernandes-Alnemri, T., et al., *The pyroptosome: a supramolecular assembly of ASC dimers mediating inflammatory cell death via caspase-1 activation*. *Cell Death Differ*, 2007. **14**(9): p. 1590-604.
111. Kuemmerle-Deschner, J.B., et al., *Diagnostic criteria for cryopyrin-associated periodic syndrome (CAPS)*. *Annals of the Rheumatic Diseases*, 2017. **76**(6): p. 942.
112. Yu, J.W., et al., *Pyrin activates the ASC pyroptosome in response to engagement by autoinflammatory PSTPIP1 mutants*. *Mol Cell*, 2007. **28**(2): p. 214-27.
113. Kuijk, L.M., et al., *HMG-CoA reductase inhibition induces IL-1beta release through Rac1/PI3K/PKB-dependent caspase-1 activation*. *Blood*, 2008. **112**(9): p. 3563-73.
114. D'Cruz, A.A., et al., *Structure and function of the SPRY/B30.2 domain proteins involved in innate immunity*. *Protein Sci*, 2013. **22**(1): p. 1-10.
115. Yang, J., H. Xu, and F. Shao, *The immunological function of familial Mediterranean fever disease protein Pyrin*. *Science China Life Sciences*, 2014. **57**(12): p. 1156-1161.
116. Medici, N.P., M. Rashid, and J.B. Bliska, *Characterization of Pyrin Dephosphorylation and Inflammasome Activation in Macrophages as Triggered by the Yersinia Effectors YopE and YopT*. *Infect Immun*, 2019. **87**(3).
117. Pras, E., et al., *Mapping of a gene causing familial Mediterranean fever to the short arm of chromosome 16*. *N Engl J Med*, 1992. **326**(23): p. 1509-13.
118. Heilig, R. and P. Broz, *Function and mechanism of the pyrin inflammasome*. *Eur J Immunol*, 2018. **48**(2): p. 230-238.
119. Moghaddas, F., et al., *A novel Pyrin-Associated Autoinflammation with Neutrophilic Dermatitis mutation further defines 14-3-3 binding of pyrin and distinction to Familial Mediterranean Fever*. *Ann Rheum Dis*, 2017. **76**(12): p. 2085-2094.
120. Masters, S.L., et al., *Familial autoinflammation with neutrophilic dermatitis reveals a regulatory mechanism of pyrin activation*. *Sci Transl Med*, 2016. **8**(332): p. 332ra45.
121. Mistry, P., et al., *Dysregulated neutrophil responses and neutrophil extracellular trap formation and degradation in PAPA syndrome*. *Ann Rheum Dis*, 2018. **77**(12): p. 1825-1833.
122. Park, Y.H., et al., *Pyrin inflammasome activation and RhoA signaling in the autoinflammatory diseases FMF and HIDS*. *Nat Immunol*, 2016. **17**(8): p. 914-21.
123. Consortium, F.F., *A candidate gene for familial Mediterranean fever*. *Nat Genet*, 1997. **17**(1): p. 25-31.
124. Özen, S., *Update on the epidemiology and disease outcome of Familial Mediterranean fever*. *Best Practice & Research Clinical Rheumatology*, 2018. **32**(2): p. 254-260.
125. Rowczenio, D.M., et al., *Autosomal dominant familial Mediterranean fever in Northern European Caucasians associated with deletion of*

- p.M694 residue-a case series and genetic exploration. Rheumatology (Oxford), 2017. 56(2): p. 209-213.*
126. Berkun, Y. and E.M. Eisenstein, *Diagnostic criteria of familial Mediterranean fever. Autoimmunity Reviews, 2014. 13(4): p. 388-390.*
  127. Bybee, A., et al., *Clinical and subclinical inflammation in patients with familial Mediterranean fever and in heterozygous carriers of MEFV mutations. Rheumatology, 2006. 45(6): p. 746-750.*
  128. SE, G., *Colchicine for Familial Mediterranean Fever. New England Journal of Medicine, 1972. 287(25): p. 1302-1302.*
  129. Zemer, D., et al., *A controlled trial of colchicine in preventing attacks of familial mediterranean fever. N Engl J Med, 1974. 291(18): p. 932-4.*
  130. Ozen, S., et al., *EULAR recommendations for the management of familial Mediterranean fever. Annals of the Rheumatic Diseases, 2016. 75(4): p. 644.*
  131. Matson, D.R. and P.T. Stukenberg, *Spindle poisons and cell fate: a tale of two pathways. Mol Interv, 2011. 11(2): p. 141-50.*
  132. Hoffman, H.M., et al., *Mutation of a new gene encoding a putative pyrin-like protein causes familial cold autoinflammatory syndrome and Muckle-Wells syndrome. Nature Genetics, 2001. 29: p. 301.*
  133. Hoffman, H., *NLRP3 Sequence variants InfEVERS Website Chief Editor Isabelle Touitou, 2019*
  134. Tanaka, N., et al., *High incidence of NLRP3 somatic mosaicism in patients with chronic infantile neurologic, cutaneous, articular syndrome: results of an International Multicenter Collaborative Study. Arthritis Rheum, 2011. 63(11): p. 3625-32.*
  135. Lachmann, H.J., et al., *The emerging role of interleukin-1beta in autoinflammatory diseases. Arthritis Rheum, 2011. 63(2): p. 314-24.*
  136. Alten, R., et al., *The human anti-IL-1 beta monoclonal antibody ACZ885 is effective in joint inflammation models in mice and in a proof-of-concept study in patients with rheumatoid arthritis. Arthritis Res Ther, 2008. 10(3): p. R67.*
  137. Lachmann, H.J., et al., *Use of Canakinumab in the Cryopyrin-Associated Periodic Syndrome. New England Journal of Medicine, 2009. 360(23): p. 2416-2425.*
  138. Williamson, L.M., et al., *Familial Hibernian fever. Q J Med, 1982. 51(204): p. 469-80.*
  139. McDermott, M.F., et al., *Germline mutations in the extracellular domains of the 55 kDa TNF receptor, TNFR1, define a family of dominantly inherited autoinflammatory syndromes. Cell, 1999. 97(1): p. 133-44.*
  140. Youngstein, T., et al., *Adult-onset tumour necrosis factor receptor-associated periodic syndrome presenting as transfusion-dependent refractory haemophagocytosis. Rheumatology (Oxford), 2018. 57(3): p. 582-583.*
  141. Lachmann, H.J., et al., *The phenotype of TNF receptor-associated autoinflammatory syndrome (TRAPS) at presentation: a series of 158 cases from the Eurofever/EUROTRAPS international registry. Ann Rheum Dis, 2014. 73(12): p. 2160-7.*
  142. Bachetti, T., et al., *Autophagy contributes to inflammation in patients with TNFR-associated periodic syndrome (TRAPS). Ann Rheum Dis, 2013. 72(6): p. 1044-52.*

143. Hull, K.M., et al., *The TNF receptor-associated periodic syndrome (TRAPS): emerging concepts of an autoinflammatory disorder*. Medicine (Baltimore), 2002. **81**(5): p. 349-68.
144. Gattorno, M., et al., *Persistent efficacy of anakinra in patients with tumor necrosis factor receptor-associated periodic syndrome*. Arthritis & Rheumatism, 2008. **58**(5): p. 1516-1520.
145. Drenth, J.P., et al., *Mutations in the gene encoding mevalonate kinase cause hyper-IgD and periodic fever syndrome*. International Hyper-IgD Study Group. Nat Genet, 1999. **22**(2): p. 178-81.
146. Favier, L.A. and G.S. Schulert, *Mevalonate kinase deficiency: current perspectives*. The application of clinical genetics, 2016. **9**: p. 101-110.
147. van der Burgh, R., et al., *Unprenylated RhoA contributes to IL-1beta hypersecretion in mevalonate kinase deficiency model through stimulation of Rac1 activity*. J Biol Chem, 2014. **289**(40): p. 27757-65.
148. Ammouri, W., et al., *Diagnostic value of serum immunoglobulinaemia D level in patients with a clinical suspicion of hyper IgD syndrome*. Rheumatology (Oxford), 2007. **46**(10): p. 1597-600.
149. ter Haar, N.M., et al., *The Phenotype and Genotype of Mevalonate Kinase Deficiency: A Series of 114 Cases From the Eurofever Registry*. Arthritis & Rheumatology, 2016. **68**(11): p. 2795-2805.
150. Simon, A., et al., *Simvastatin Treatment for Inflammatory Attacks of the Hyperimmunoglobulinemia D and Periodic Fever Syndrome*. Clinical Pharmacology & Therapeutics, 2004. **75**(5): p. 476-483.
151. Zhang, S., *Natural history of mevalonate kinase deficiency: a literature review*. Pediatric rheumatology online journal, 2016. **14**(1): p. 30-30.
152. ter Haar, N.M., et al., *Recommendations for the management of autoinflammatory diseases*. Ann Rheum Dis, 2015. **74**(9): p. 1636-44.
153. Rafiq, N.K., et al., *Tocilizumab for the Treatment of Mevalonate Kinase Deficiency*. Case Reports in Pediatrics, 2018. **2018**: p. 6.
154. Arkwright, P.D., M. Abinun, and A.J. Cant, *Mevalonic aciduria cured by bone marrow transplantation*. N Engl J Med, 2007. **357**(13): p. 1350.
155. Navon Elkan, P., et al., *Mutant adenosine deaminase 2 in a polyarteritis nodosa vasculopathy*. N Engl J Med, 2014. **370**(10): p. 921-31.
156. Zhou, Q., et al., *Early-onset stroke and vasculopathy associated with mutations in ADA2*. N Engl J Med, 2014. **370**(10): p. 911-20.
157. Zavialov, A.V. and A. Engstrom, *Human ADA2 belongs to a new family of growth factors with adenosine deaminase activity*. Biochem J, 2005. **391**(Pt 1): p. 51-7.
158. Nanthapaisal, S., et al., *Deficiency of Adenosine Deaminase Type 2: A Description of Phenotype and Genotype in Fifteen Cases*. Arthritis Rheumatol, 2016. **68**(9): p. 2314-22.
159. Gaspar, H.B., et al., *How I treat ADA deficiency*. Blood, 2009. **114**(17): p. 3524-32.
160. Ledue, T.B., et al., *Analytical evaluation of particle-enhanced immunonephelometric assays for C-reactive protein, serum amyloid A and mannose-binding protein in human serum*. Ann Clin Biochem, 1998. **35** ( Pt 6): p. 745-53.
161. Poole, S., et al., *The first international standard for serum amyloid A protein (SAA). Evaluation in an international collaborative study*. J Immunol Methods, 1998. **214**(1-2): p. 1-10.



162. Talmud, P., et al., *Rapid screening for specific mutations in patients with a clinical diagnosis of familial hypercholesterolaemia*. *Atherosclerosis*, 1991. **89**(2-3): p. 137-41.
163. Hutt, D.F., et al., *Prognostic utility of the Perugini grading of 99mTc-DPD scintigraphy in transthyretin (ATTR) amyloidosis and its relationship with skeletal muscle and soft tissue amyloid*. *Eur Heart J Cardiovasc Imaging*, 2017. **18**(12): p. 1344-1350.
164. Hutt, D.F., et al., *Utility and limitations of 3,3-diphosphono-1,2-propanodicarboxylic acid scintigraphy in systemic amyloidosis*. *Eur Heart J Cardiovasc Imaging*, 2014. **15**(11): p. 1289-98.
165. Benson MD, U.T., *Transthyretin amyloidosis*. *Amyloid: Int J Exp Clin Invest.*, 1996. **3**: p. 44-56.
166. Rapezzi, C., et al., *Phenotypic and genotypic heterogeneity in transthyretin-related cardiac amyloidosis: towards tailoring of therapeutic strategies?* *Amyloid*, 2006. **13**(3): p. 143-53.
167. Mangione, P.P., et al., *Proteolytic cleavage of Ser52Pro variant transthyretin triggers its amyloid fibrillogenesis*. *Proc Natl Acad Sci U S A*, 2014. **111**(4): p. 1539-44.
168. Waddington-Cruz, M., et al., *Hereditary transthyretin amyloidosis: baseline characteristics of patients in the NEURO-TTR trial*. *Amyloid*, 2018. **25**(3): p. 180-188.
169. Cornwell, G.G., 3rd, et al., *Frequency and distribution of senile cardiovascular amyloid. A clinicopathologic correlation*. *Am J Med*, 1983. **75**(4): p. 618-23.
170. Tanskanen, M., et al., *Senile systemic amyloidosis affects 25% of the very aged and associates with genetic variation in alpha2-macroglobulin and tau: a population-based autopsy study*. *Ann Med*, 2008. **40**(3): p. 232-9.
171. Gonzalez-Lopez, E., et al., *Wild-type transthyretin amyloidosis as a cause of heart failure with preserved ejection fraction*. *Eur Heart J*, 2015. **36**(38): p. 2585-94.
172. Sekijima, Y., et al., *High prevalence of wild-type transthyretin deposition in patients with idiopathic carpal tunnel syndrome: a common cause of carpal tunnel syndrome in the elderly*. *Hum Pathol*, 2011. **42**(11): p. 1785-91.
173. Niggemeyer, O., et al., *Amyloid deposition in osteoarthritis of the hip*. *Arch Orthop Trauma Surg*, 2011. **131**(5): p. 637-43.
174. Yanagisawa, A., et al., *Amyloid deposits derived from transthyretin in the ligamentum flavum as related to lumbar spinal canal stenosis*. *Mod Pathol*, 2015. **28**(2): p. 201-7.
175. From, A.M., J.J. Maleszewski, and C.S. Rihal, *Current status of endomyocardial biopsy*. *Mayo Clin Proc*, 2011. **86**(11): p. 1095-102.
176. Quarta, C.C., J.L. Kruger, and R.H. Falk, *Cardiac amyloidosis*. *Circulation*, 2012. **126**(12): p. e178-82.
177. Gonzalez-Lopez, E., A. Lopez-Sainz, and P. Garcia-Pavia, *Diagnosis and Treatment of Transthyretin Cardiac Amyloidosis. Progress and Hope*. *Rev Esp Cardiol (Engl Ed)*, 2017. **70**(11): p. 991-1004.
178. Dzungu, J.N., et al., *Cardiac transthyretin amyloidosis*. *Heart*, 2012. **98**(21): p. 1546-54.

179. Gertz, M.A., et al., *Diagnosis, Prognosis, and Therapy of Transthyretin Amyloidosis*. J Am Coll Cardiol, 2015. **66**(21): p. 2451-2466.
180. Coelho, T., et al., *Safety and efficacy of RNAi therapy for transthyretin amyloidosis*. N Engl J Med, 2013. **369**(9): p. 819-29.
181. Ackermann, E.J., et al., *Suppressing transthyretin production in mice, monkeys and humans using 2nd-Generation antisense oligonucleotides*. Amyloid, 2016. **23**(3): p. 148-157.
182. Castano, A., et al., *Diflunisal for ATTR cardiac amyloidosis*. Congest Heart Fail, 2012. **18**(6): p. 315-9.
183. Ikram, A., et al., *Diflunisal tolerability in transthyretin cardiac amyloidosis: a single center's experience*. Amyloid, 2018. **25**(3): p. 197-202.
184. Higaki, J.N., et al., *Novel conformation-specific monoclonal antibodies against amyloidogenic forms of transthyretin*. Amyloid, 2016. **23**(2): p. 86-97.
185. Ward, J.E., et al., *Doxycycline reduces fibril formation in a transgenic mouse model of AL amyloidosis*. Blood, 2011. **118**(25): p. 6610-7.
186. Karlstedt, E., et al., *Clinical Experience With the Use of Doxycycline and Ursodeoxycholic Acid for the Treatment of Transthyretin Cardiac Amyloidosis*. J Card Fail, 2019.
187. Tennent, G.A., et al., *Congo red overlay immunohistochemistry aids classification of amyloid deposits*, in *Amyloid and Amyloidosis 1998*, R.A. Kyle and M.A. Gertz, Editors. 1999, Parthenon Publishing: Pearl River, New York. p. 160-162.
188. Vrana, J.A., et al., *Classification of amyloidosis by laser microdissection and mass spectrometry-based proteomic analysis in clinical biopsy specimens*. Blood, 2009. **114**(24): p. 4957-9.
189. Booth, D.R., et al., *A novel variant of transthyretin, 59Thr-->Lys, associated with autosomal dominant cardiac amyloidosis in an Italian family*. Circulation, 1995. **91**(4): p. 962-7.
190. Surawicz, B. and T.K. Knilans, *Chou's Electrocardiography in Clinical Practice: Adult & Pediatric*. 5th ed. 2001, Philadelphia: W.B. Saunders.
191. Galderisi, M., *Diastolic dysfunction and diastolic heart failure: diagnostic, prognostic and therapeutic aspects*. Cardiovasc Ultrasound, 2005. **3**: p. 9.
192. Gertz, M.A., et al., *Definition of organ involvement and treatment response in immunoglobulin light chain amyloidosis (AL): a consensus opinion from the 10th International Symposium on Amyloid and Amyloidosis, Tours, France, 18-22 April 2004*. Am J Hematol, 2005. **79**(4): p. 319-28.
193. Carroll, J.D., W.H. Gaasch, and K.P. McAdam, *Amyloid cardiomyopathy: characterization by a distinctive voltage/mass relation*. Am J Cardiol, 1982. **49**(1): p. 9-13.
194. Palladini, G., et al., *Serum N-terminal pro-brain natriuretic peptide is a sensitive marker of myocardial dysfunction in AL amyloidosis*. Circulation, 2003. **107**(19): p. 2440-5.
195. Dispenzieri, A., et al., *Survival in patients with primary systemic amyloidosis and raised serum cardiac troponins*. Lancet, 2003. **361**(9371): p. 1787-9.

196. Tabbibizar, R. and A. Maisel, *The impact of B-type natriuretic peptide levels on the diagnoses and management of congestive heart failure.* Curr Opin Cardiol, 2002. **17**(4): p. 340-5.
197. Hawkins, P.N., J.P. Lavender, and M.B. Pepys, *Evaluation of systemic amyloidosis by scintigraphy with 123I-labeled serum amyloid P component.* N Engl J Med, 1990. **323**(8): p. 508-13.
198. Gonzalez-Lopez, E., et al., *Clinical characteristics of wild-type transthyretin cardiac amyloidosis: disproving myths.* Eur Heart J, 2017.
199. Hammarstrom, P., et al., *Prevention of transthyretin amyloid disease by changing protein misfolding energetics.* Science, 2003. **299**(5607): p. 713-6.
200. Atroshi, I., et al., *Prevalence of carpal tunnel syndrome in a general population.* JAMA, 1999. **282**(2): p. 153-8.
201. Bland, J.D., *Carpal tunnel syndrome.* BMJ, 2007. **335**(7615): p. 343-6.
202. Gelberman, R.H., et al., *The carpal tunnel syndrome. A study of carpal canal pressures.* J Bone Joint Surg Am, 1981. **63**(3): p. 380-3.
203. Bland, J.D. and S.M. Rudolfer, *Clinical surveillance of carpal tunnel syndrome in two areas of the United Kingdom, 1991-2001.* J Neurol Neurosurg Psychiatry, 2003. **74**(12): p. 1674-9.
204. Bagatur, A.E. and G. Zorer, *The carpal tunnel syndrome is a bilateral disorder.* J Bone Joint Surg Br, 2001. **83**(5): p. 655-8.
205. NICE, *Carpal Tunnel Syndrome National Institute of Clinical Excellence Clinical Knowledge Summary 2016.*
206. Petrover, D. and P. Richette, *Treatment of carpal tunnel syndrome: from ultrasonography to ultrasound surgery.* Joint Bone Spine, 2017.
207. Liedke, P.E. and P.E. Goss, *Aromatase inhibitors and musculoskeletal adverse events.* Lancet Oncol, 2012. **13**(4): p. 333-4.
208. Hakim, A.J., et al., *The genetic contribution to carpal tunnel syndrome in women: a twin study.* Arthritis Rheum, 2002. **47**(3): p. 275-9.
209. Maceira, A.M., et al., *Cardiovascular magnetic resonance and prognosis in cardiac amyloidosis.* J. Cardiovasc. Magn. Reson., 2008. **10**: p. 54.
210. Stein, K., et al., *Chemical heterogeneity of amyloid in the carpal tunnel syndrome.* Virchows Arch A Pathol Anat Histopathol, 1987. **412**(1): p. 37-45.
211. Nakamichi, K.I. and S. Tachibana, *Amyloid deposition in the synovium and ligament in idiopathic carpal tunnel syndrome.* Muscle Nerve, 1996. **19**(10): p. 1349-51.
212. Jacobson, D.R. and J.N. Buxbaum, *A double-variant transthyretin allele (Ser 6, Ile 33) in the Israeli patient "SKO" with familial amyloidotic polyneuropathy.* Hum Mutat, 1994. **3**(3): p. 254-60.
213. Sperry, B.W., et al., *Tenosynovial and Cardiac Amyloidosis in Patients Undergoing Carpal Tunnel Release.* J Am Coll Cardiol, 2018. **72**(17): p. 2040-2050.
214. Mangione, P.P., et al., *Plasminogen activation triggers transthyretin amyloidogenesis in vitro.* J Biol Chem, 2018. **293**(37): p. 14192-14199.
215. Clavel, M.A., et al., *Outcome of patients with aortic stenosis, small valve area, and low-flow, low-gradient despite preserved left ventricular ejection fraction.* J Am Coll Cardiol, 2012. **60**(14): p. 1259-67.
216. Treibel, T.A., et al., *Occult Transthyretin Cardiac Amyloid in Severe Calcific Aortic Stenosis: Prevalence and Prognosis in Patients*

- Undergoing Surgical Aortic Valve Replacement. Circ Cardiovasc Imaging*, 2016. **9**(8).
217. Morishita, Y., et al., *Measurement of the local pressure of the intervertebral foramen and the electrophysiologic values of the spinal nerve roots in the vertebral foramen. Spine (Phila Pa 1976)*, 2006. **31**(26): p. 3076-80.
  218. Andersson, K.E. and A. Arner, *Urinary bladder contraction and relaxation: physiology and pathophysiology. Physiol Rev*, 2004. **84**(3): p. 935-86.
  219. Rosier, P., C.S. Ten Donkelaar, and L.M.O. de Kort, *Clinical Epidemiology: Detrusor Voiding Contraction Maximum Power, Related to Ageing. Urology*, 2018.
  220. Sueyoshi, T., et al., *Wild-type transthyretin-derived amyloidosis in various ligaments and tendons. Hum Pathol*, 2011. **42**(9): p. 1259-64.
  221. Cole, A.S., et al., *Localised deposition of amyloid in tears of the rotator cuff. J Bone Joint Surg Br*, 2001. **83**(4): p. 561-4.
  222. Gu, Y.J., et al., *Clinical and laboratory characteristics of patients having amyloidogenic transthyretin deposition in osteoarthritic knee joints. J Zhejiang Univ Sci B*, 2014. **15**(1): p. 92-9.
  223. Akasaki, Y., et al., *Transthyretin deposition in articular cartilage: a novel mechanism in the pathogenesis of osteoarthritis. Arthritis Rheumatol*, 2015. **67**(8): p. 2097-107.
  224. Maurer, M.S., M.B. Sultan, and C. Rapezzi, *Tafamidis for Transthyretin Amyloid Cardiomyopathy. N Engl J Med*, 2019. **380**(2): p. 196-197.
  225. Chen, M., et al., *Serum amyloid A1 isoforms display different efficacy at Toll-like receptor 2 and formyl peptide receptor 2. Immunobiology*, 2014. **219**(12): p. 916-23.
  226. Rennegarbe, M., et al., *Influence of C-terminal truncation of murine Serum amyloid A on fibril structure. Sci Rep*, 2017. **7**(1): p. 6170.
  227. Hijmans, W. and J.D. Sipe, *Levels of the serum amyloid A protein (SAA) in normal persons of different age groups. Clin Exp Immunol*, 1979. **35**(1): p. 96-100.
  228. Papa, R. and H.J. Lachmann, *Secondary, AA, Amyloidosis. Rheum Dis Clin North Am*, 2018. **44**(4): p. 585-603.
  229. Lachmann, H.J., et al., *Use of canakinumab in the cryopyrin-associated periodic syndrome. N Engl J Med*, 2009. **360**(23): p. 2416-25.
  230. Alishiri, G.H., et al., *Prevalence of amyloid deposition in long standing rheumatoid arthritis in Iranian patients by abdominal subcutaneous fat biopsy and assessment of clinical and laboratory characteristics. BMC Musculoskelet Disord*, 2006. **7**: p. 43.
  231. Ozen, S., et al., *Results from a multicentre international registry of familial Mediterranean fever: impact of environment on the expression of a monogenic disease in children. Ann Rheum Dis*, 2014. **73**(4): p. 662-7.
  232. WHO, *World Health Organisation Topic: Obesity World Health Organisation* 2019.
  233. Stankovic Stojanovic, K., et al., *AA amyloidosis is an emerging cause of nephropathy in obese patients. European Journal of Internal Medicine*, 2017. **39**: p. e18-e20.
  234. Blank, N., et al., *Obesity is a significant susceptibility factor for idiopathic AA amyloidosis. Amyloid*, 2018. **25**(1): p. 37-45.

235. NHEngland, *Obesity, Physical Activity and Diet, England 2015*.
236. Youngstein T, L.T., Pinney J, Gilbertson J, Rezk T, Manwani R, Quarta C, Wechalekar A, Mahmood S, Sachchithanantham S, Gillmore JD, Hawkins PN, Lachmann HJ., *Adipocyte production of inflammatory cytokines may be contributory in cases of AA Amyloidosis of unknown aetiology*. 9th ISSAID Congress Oral Abstract 2017.
237. Lyon, C.J., R.E. Law, and W.A. Hsueh, *Minireview: Adiposity, Inflammation, and Atherogenesis*. *Endocrinology*, 2003. **144**(6): p. 2195-2200.
238. Weisberg, S.P., et al., *Obesity is associated with macrophage accumulation in adipose tissue*. *J Clin Invest*, 2003. **112**(12): p. 1796-808.
239. Naeser, P. and P. Westermark, *Amyloidosis in ageing obese-hyperglycemic mice and their lean litter-mates. A morphological study*. *Acta Pathol Microbiol Scand A*, 1977. **85**(6): p. 761-7.
240. van der Heijden, R.A., et al., *Obesity-induced chronic inflammation in high fat diet challenged C57BL/6J mice is associated with acceleration of age-dependent renal amyloidosis*. *Sci Rep*, 2015. **5**: p. 16474.
241. Clement, K., et al., *A mutation in the human leptin receptor gene causes obesity and pituitary dysfunction*. *Nature*, 1998. **392**(6674): p. 398-401.
242. Poitou, C., et al., *Serum amyloid A: production by human white adipocyte and regulation by obesity and nutrition*. *Diabetologia*, 2005. **48**(3): p. 519-528.
243. Gómez-Ambrosi, J., et al., *Increased Serum Amyloid A Concentrations in Morbid Obesity Decrease after Gastric Bypass*. *Obesity Surgery*, 2006. **16**(3): p. 262-269.
244. Steinberger, J., et al., *Comparison of body fatness measurements by BMI and skinfolds vs dual energy X-ray absorptiometry and their relation to cardiovascular risk factors in adolescents*. *Int J Obes (Lond)*, 2005. **29**(11): p. 1346-52.
245. Kidney.org.uk, *Trasnplant Cost Effectiveness*. Kidney Patients UK 2019.
246. Goldbach-Mansky, R., *Blocking interleukin-1 in rheumatic diseases*. *Ann N Y Acad Sci*, 2009. **1182**: p. 111-23.
247. Stojanov, S. and D.L. Kastner, *Familial autoinflammatory diseases: genetics, pathogenesis and treatment*. *Curr Opin Rheumatol*, 2005. **17**(5): p. 586-99.
248. Gotestam Skorpen, C., et al., *The EULAR points to consider for use of antirheumatic drugs before pregnancy, and during pregnancy and lactation*. 2016. **75**(5): p. 795-810.
249. <http://www.ema.europa.eu/>, *Summary Product Characteristics: Anakinra* [http://www.ema.europa.eu/docs/en\\_GB/document\\_library/EPAR\\_-\\_Assessment\\_Report\\_-\\_Variation/human/000363/WC500156808.pdf](http://www.ema.europa.eu/docs/en_GB/document_library/EPAR_-_Assessment_Report_-_Variation/human/000363/WC500156808.pdf). 2013.
250. Fischer-Betz, R., C. Specker, and M. Schneider, *Successful outcome of two pregnancies in patients with adult-onset Still's disease treated with IL-1 receptor antagonist (anakinra)*. *Clin. Exp. Rheumatol.*, 2011. **29**: p. 1021-1023.
251. Berger, C.T., et al., *A patient's wish: anakinra in pregnancy*. *Ann Rheum Dis*, 2009. **68**(11): p. 1794-5.

252. Chang, Z., et al., *Anakinra use during pregnancy in patients with cryopyrin-associated periodic syndromes (CAPS)*. *Arthritis Rheumatol*, 2014. **66**(11): p. 3227-32.
253. Chakraborty, A., et al., *Pharmacokinetic and pharmacodynamic properties of canakinumab, a human anti-interleukin-1beta monoclonal antibody*. *Clin Pharmacokinet*, 2012. **51**(6): p. e1-18.
254. Kapur, S. and M.E. Bonk, *Riloncept (arcalyst), an interleukin-1 trap for the treatment of cryopyrin-associated periodic syndromes*. *Plat*, 2009. **34**(3): p. 138-41.
255. [www.fda.gov](http://www.fda.gov), *Summary Product Characteristics: Riloncept* <http://www.fda.gov/downloads/AdvisoryCommittees/CommitteesMeetingMaterials/Drugs/ArthritisAdvisoryCommittee/UCM302884.pdf> 2012.
256. Yanmaz, M.N., A.J. Ozcan, and K. Savan, *The impact of familial Mediterranean fever on reproductive system*. *Clin Rheumatol*, 2014. **33**(10): p. 1385-8.
257. Ben-Chetrit, E. and M. Levy, *Reproductive system in familial Mediterranean fever: an overview*. *Ann Rheum Dis*, 2003. **62**(10): p. 916-9.
258. Ozen, S., et al., *Renal anomalies associated with ectopic neurohypophysis*. *J Clin Res Pediatr Endocrinol*, 2011. **3**(2): p. 56-9.
259. Arnhold, I.J., et al., *Role of GLI2 in hypopituitarism phenotype*. *J Mol Endocrinol*, 2015. **54**(3): p. R141-50.
260. Jenkins, D., P.J. Winyard, and A.S. Woolf, *Immunohistochemical analysis of Sonic hedgehog signalling in normal human urinary tract development*. *J Anat*, 2007. **211**(5): p. 620-9.
261. Rider, R.A., et al., *Association of twinning and maternal age with major structural birth defects in Utah, 1999 to 2008*. *Birth Defects Res A Clin Mol Teratol*, 2013. **97**(8): p. 554-63.
262. Wiesel, A., et al., *Prenatal detection of congenital renal malformations by fetal ultrasonographic examination: an analysis of 709,030 births in 12 European countries*. *Eur J Med Genet*, 2005. **48**(2): p. 131-44.
263. Simon, C., et al., *Molecular interactions between embryo and uterus in the adhesion phase of human implantation*. *Hum Reprod*, 1998. **13 Suppl 3**: p. 219-32; discussion 233-6.
264. Wang, J., et al., *Anakinra and etanercept prevent embryo loss in pregnant nonobese diabetic mice*. *Reproduction*, 2015. **149**(4): p. 377-84.
265. Fischer-Betz, R., C. Specker, and M. Schneider, *Successful outcome of two pregnancies in patients with adult-onset Still's disease treated with IL-1 receptor antagonist (anakinra)*. *Clin Exp Rheumatol*, 2011. **29**(6): p. 1021-3.
266. Schinzel, A., et al., *The "cat eye syndrome": dicentric small marker chromosome probably derived from a no.22 (tetrasomy 22pter to q11) associated with a characteristic phenotype. Report of 11 patients and delineation of the clinical picture*. *Hum Genet*, 1981. **57**(2): p. 148-58.
267. Hershfield, M.S., *New insights into adenosine-receptor-mediated immunosuppression and the role of adenosine in causing the immunodeficiency associated with adenosine deaminase deficiency*. *Eur J Immunol*, 2005. **35**(1): p. 25-30.

268. Iwaki-Egawa, S., T. Yamamoto, and Y. Watanabe, *Human plasma adenosine deaminase 2 is secreted by activated monocytes*. *Biol Chem*, 2006. **387**(3): p. 319-21.
269. Zavialov, A.V., et al., *Structural basis for the growth factor activity of human adenosine deaminase ADA2*. *J Biol Chem*, 2010. **285**(16): p. 12367-77.
270. Zavialov, A.V., et al., *Human adenosine deaminase 2 induces differentiation of monocytes into macrophages and stimulates proliferation of T helper cells and macrophages*. *J Leukoc Biol*, 2010. **88**(2): p. 279-90.
271. Iijima, R., et al., *The extracellular adenosine deaminase growth factor, ADGF/CECR1, plays a role in Xenopus embryogenesis via the adenosine/P1 receptor*. *J Biol Chem*, 2008. **283**(4): p. 2255-64.
272. Riazi, A.M., G. Van Arsdell, and M. Buchwald, *Transgenic expression of CECR1 adenosine deaminase in mice results in abnormal development of heart and kidney*. *Transgenic Res*, 2005. **14**(3): p. 333-6.
273. Sari, R.A., et al., *Correlation of serum levels of adenosine deaminase activity and its isoenzymes with disease activity in rheumatoid arthritis*. *Clin Exp Rheumatol*, 2003. **21**(1): p. 87-90.
274. Fernandez, E., et al., *Adenosine deaminase isoenzymes and neopterin in liver cirrhosis*. *J Clin Gastroenterol*, 2000. **30**(2): p. 181-6.
275. Karmouty-Quintana, H., Y. Xia, and M.R. Blackburn, *Adenosine signaling during acute and chronic disease states*. *J Mol Med (Berl)*, 2013. **91**(2): p. 173-81.
276. Batu, E.D., et al., *A Case Series of Adenosine Deaminase 2-deficient Patients Emphasizing Treatment and Genotype-phenotype Correlations*. *J Rheumatol*, 2015. **42**(8): p. 1532-4.
277. Kaljas, Y., et al., *Human adenosine deaminases ADA1 and ADA2 bind to different subsets of immune cells*. *Cell Mol Life Sci*, 2017. **74**(3): p. 555-570.
278. Van Montfrans, J.M., et al., *Phenotypic variability in patients with ADA2 deficiency due to identical homozygous R169Q mutations*. *Rheumatology (Oxford)*, 2016. **55**(5): p. 902-10.
279. Caorsi, R., et al., *ADA2 deficiency (DADA2) as an unrecognised cause of early onset polyarteritis nodosa and stroke: a multicentre national study*. *Ann Rheum Dis*, 2017. **76**(10): p. 1648-1656.
280. Moens, L., et al., *Human adenosine deaminase 2 deficiency: A multifaceted inborn error of immunity*. *Immunol Rev*, 2019. **287**(1): p. 62-72.
281. Meyts, I. and I. Aksentijevich, *Deficiency of Adenosine Deaminase 2 (DADA2): Updates on the Phenotype, Genetics, Pathogenesis, and Treatment*. *J Clin Immunol*, 2018. **38**(5): p. 569-578.
282. Van Eyck, L., Jr., et al., *Hematopoietic stem cell transplantation rescues the immunologic phenotype and prevents vasculopathy in patients with adenosine deaminase 2 deficiency*. *J Allergy Clin Immunol*, 2015. **135**(1): p. 283-7 e5.
283. Gonzalez Santiago, T.M., et al., *Dermatologic Features of ADA2 Deficiency in Cutaneous Polyarteritis Nodosa*. *JAMA Dermatol*, 2015. **151**(11): p. 1230-4.

284. Poswar Fde, O., et al., *Adenosine deaminase 2 deficiency presenting as spastic paraplegia and systemic vasculitis*. J Neurol, 2016. **263**(4): p. 818-20.
285. Alsultan, A., et al., *Deficiency of ADA2 mimicking autoimmune lymphoproliferative syndrome in the absence of livedo reticularis and vasculitis*. Pediatr Blood Cancer, 2018. **65**(4).
286. Ben-Ami, T., et al., *Extending the Clinical Phenotype of Adenosine Deaminase 2 Deficiency*. J Pediatr, 2016. **177**: p. 316-320.
287. Hashem, H., R. Egler, and J. Dalal, *Refractory Pure Red Cell Aplasia Manifesting as Deficiency of Adenosine Deaminase 2*. J Pediatr Hematol Oncol, 2017. **39**(5): p. e293-e296.
288. Cipe, F.E., et al., *Novel Mutation in CECR1 Leads to Deficiency of ADA2 with Associated Neutropenia*. J Clin Immunol, 2018. **38**(3): p. 273-277.
289. Trotta, L., et al., *ADA2 deficiency: Clonal lymphoproliferation in a subset of patients*. J Allergy Clin Immunol, 2018. **141**(4): p. 1534-1537 e8.
290. Arts, K., et al., *Warts and DADA2: a Mere Coincidence?* J Clin Immunol, 2018. **38**(8): p. 836-843.
291. Schepp, J., et al., *Screening of 181 Patients With Antibody Deficiency for Deficiency of Adenosine Deaminase 2 Sheds New Light on the Disease in Adulthood*. Arthritis Rheumatol, 2017. **69**(8): p. 1689-1700.
292. Santo, G.C., et al., *Adenosine Deaminase Two and Immunoglobulin M Accurately Differentiate Adult Sneddon's Syndrome of Unknown Cause*. Cerebrovasc Dis, 2019. **46**(5-6): p. 257-264.
293. Muraoka, T., et al., *Automated enzymatic measurement of adenosine deaminase isoenzyme activities in serum*. Anal Biochem, 1990. **187**(2): p. 268-72.
294. Jarrot, P.A. and G. Kaplanski, *Anti-TNF-alpha therapy and systemic vasculitis*. Mediators Inflamm, 2014. **2014**: p. 493593.
295. Ruperto, N., et al., *Consensus procedures and their role in pediatric rheumatology*. Curr Rheumatol Rep, 2008. **10**(2): p. 142-6.
296. Pill, J., *The Delphi method: Substance, context, a critique and an annotated bibliography*. Socio-Economic Planning Sciences, 1971. **5**(1): p. 57-71.
297. Batu, E.D., et al., *A case series of adenosine deaminase 2 deficient patients emphasizing treatment and genotype-phenotype correlations*. Pediatric Rheumatology Online Journal, 2015. **13**(Suppl 1): p. P62-P62.